



Union Special[®]
INDUSTRIAL SEWING EQUIPMENT

STYLES

61900

LIST OF PARTS
FOR STYLES
61900A 61900B

CATALOG
NO. T108L

SECOND
EDITION

SECOND EDITION
© 1974

PRINTED IN USA

INFORMATION SUBJECT TO CHANGE WITHOUT NOTICE

© UNION SPECIAL CORPORATION ALL RIGHTS RESERVED IN ALL COUNTRIES.

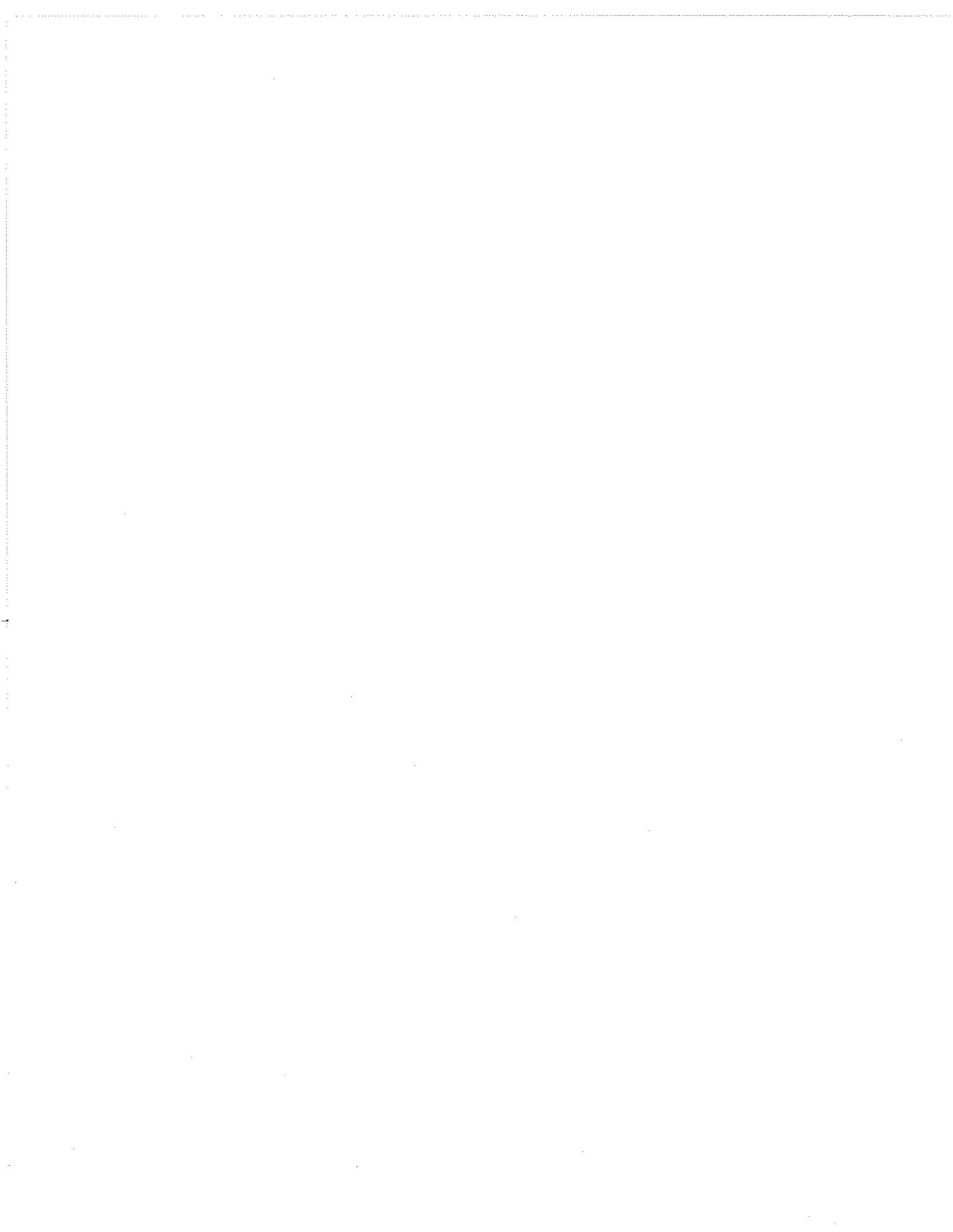

IDENTIFICATION OF MACHINES

Each Union Special machine is identified by a Style number which is stamped into the name plate on the machine.

Machines similar in construction are grouped by a class number, which contains no letters. Example: "Class 61900". Letters suffixed to a class number indicates the standard Style of a machine. Example: "61900 A". Letter "Z" is reserved as a suffix to the standard Style identification to specify machine is of "Special" construction. Example: "61900 AZ".

APPLICATION OF CATALOG

This catalog applies specifically to the standard Styles of machines as listed herein. It can also be applied with discretion to some Special machines in Class 61900. All references to direction, such as left and right, front and back, etc., are taken from the operator's position while seated at the machine. Operating direction of hand-wheel is toward the operator.

STYLES OF MACHINES IN CLASS 61900

Streamlined Flat Bed Lockstitch Machine, Single Needle, Light, Medium and Heavy Duty, Needle Feed and Drop Feed, Rotary Hook, Horizontal Hook Shaft, Push Button Stitch Regulator, One Reservoir Enclosed Automatic Lubricating System for Main Driving Mechanism, Separate Reservoir for Automatic Lubrication of Rotary Hook, Upper Left Head Mechanism Manually Lubricated, Maximum Work Space to Right of Needle Bar 11 3/8 Inches.

61900 A For miscellaneous plain seaming operations on light and medium weight work, 1 9/64 inch needle bar travel. Type 183 GXS or 183 GYS needle.

61900 B For miscellaneous plain seaming operations on medium to medium heavy weight work, 1 13/64 inch needle bar travel. Type 180 GXS or 180 GYS needle.

Note: For number necessary to complete the Styling of a 61900 A or 61900 B, refer to Pages 4 and 5. The number indicates a certain sewing combination - presser foot, throat plate and feed dog.

NEEDLES

Each Union Special needle has both a type number and a size number. The type number denotes the kind of shank, point, length, groove, finish and other details. The size number stamped on the needle shank, denotes the largest diameter of the blade measured in thousandths of an inch across the eye. Collectively, the type number and size number represent the complete symbol.

To have orders promptly and accurately filled, forward the empty package, a sample needle, or the type and size number should be given. Use description on label. A complete order would read as follows: "1000 Needles, Type 183 GXS, Size 032".

The type numbers of the needles recommended for each style of machine covered by this catalog are given in the machine style description. Other needles are available, but the ones indicated are those recommended to produce the most satisfactory results. The type numbers of the recommended needles, together with their descriptions, and the sizes available are listed below:

<u>Type No.</u>	<u>Description and Sizes</u>
180 GXS	Round shank, round point, lockstitch, short length, ball eye, single groove, wide angle groove, struck groove, deep spot, ball point, chromium plated - sizes 028, 032, 036, 040, 044, 048, 054, 060.
180 GYS	Round shank, round point, lockstitch, short length, ball eye, single groove, wide angle groove, struck groove, deep spot, chromium plated - sizes 028, 032, 036, 040, 044, 048, 054, 060.
183 GXS	Round shank, round point, lockstitch, extra short length, ball eye, single groove, wide angle groove, struck groove, deep spot, ball point, chromium plated - sizes 028, 032, 036, 040, 044.
183 GYS	Round shank, round point, lockstitch, extra short length, ball eye, single groove, wide angle groove, struck groove, deep spot, chromium plated - sizes 028, 032, 036, 040, 044.

Selection of proper needle size should be determined by size of thread used. Thread should pass freely through needle eye in order to produce a good stitch formation.

For best results, use only genuine Union Special needles in the operation of these machines. They are packaged under our brand name *Union Special* which is backed by a reputation for producing highest quality needles for more than three-quarters of a century.

IDENTIFYING PARTS

Where the construction permits, each part is stamped with its part number. On some smaller parts, and on those where construction does not permit, an identification letter is stamped in to distinguish the part from similar ones.

All part numbers represent the same part, regardless of the catalog in which they appear.

STYLE NUMBERS NECESSARY TO COMPLETE STYLING OF 61900 A & B

(AFTER EACH STYLE NUMBER IS LISTED THE PRESSER FOOT, THROAT PLATE AND FEED DOG MAKING UP THE SPECIFIC STYLE. WHERE MORE THAN ONE PART NUMBER IS SHOWN FOR A SPECIFIC STYLE, ONLY ONE WILL BE FURNISHED WITH EACH MACHINE. IN ALL CASES, THE STYLE NUMBER WILL BE LISTED AND THE PRESSER FOOT, FEED DOG AND THROAT PLATE MUST ALSO BE LISTED ON S. R.)

<u>STYLE NUMBER</u>	<u>PRESSER FOOT</u>	<u>FEED DOG</u>	<u>THROAT PLATE</u>	<u>STITCH RANGE</u>
1	61920 L	61926 D	*61928 B	12-16
2	61920 S	61926 D	*61928 B	12-16
2-A	L440 A			
2-B	61920 M			
3	61920 B	61926	*61928	11-18
3-A	61920 S			
4	61927 A	61926 A	*61928 A	11-18
4-A	61320 P			
4-B	61420 R			
4-C	61920 B			
5	61420 BT	61905 B-063 or 073 or 083	61924 B	7-18
5-A	L440 A			
6	61920 F	61905 F-063	61924 C	7-18
7	61920 J	61926	*61928	11-18
7-A	L471 A			
7-B	61920 P			
8	61920 B	61905 J-063	61924 J	7-18
9	61920 J	61905 J-063	61924 J	7-18
9-A	L471 A			
10	61920 A	61905 C-073	61924 C	7-18
10-A	61920 S			
11	61920 C	61905 C-073	61924 C	7-18
12	61920 S	61905 K-073 or 083	61924 K	7-18
12-A	61920 A			
12-B	61320 P			
13	61920 J	61905 E-073	61924 E	7-18
14	61920 J	61905 G-073 or 083	61924 G	7-18
15	61920 A	61905 B-063 or 073 or 083	61924 B	7-18
16	61920 R	61905 J-063	61924 J	7-18
17	61920 N	61926 D	*61928 B	12-16
18	61420 BT	61926	*61928	11-18
18-A	61920 C			
19	L310 A	61926	*61928	11-18
20	61320 P	61905 E-073	61924 E	7-18
20-A	61420 BT			
20-B	L440 A			

* Needle hole in throat plate (.053 needle slot)

<u>STYLE NUMBER</u>	<u>PRESSER FOOT</u>	<u>FEED DOG</u>	<u>THROAT PLATE</u>	<u>STITCH RANGE</u>
21	61920 P	61926 C	*61928 B	12-16
21-A	61920 S			
21-B	61920 L			
21-C	61420 BU			
22	61920 M	61926 C	*61928 B	12-16
23	61420 BU	61926 H	#61928 H or 050	9-18
23-A	61920 S			
24	61420	61905 K-073 or 083	61924 K	7-18
25	61420 BT	61905 M-063	61924 E	7-18
26	61920 B	61905 C-073	61924 C	7-18
27	61920 B	61926 C	*61928 B	12-16
28	61920 B	61905 E-073	61924 E	7-18
28-A	61920 A			
29	61420 BT	61905 J-063	61924 J	7-18
30	61920 L	61926	*61928	11-18
30-A	61920 A			
31	61420 AP	61926	*61928	11-18
31-A	61920 M			
32	61920 R	61926	*61928	11-18
33	61920 M	61926 E	*61928 C	12-16
34	61920 B	61926 T	*61928	11-18
35	61920 M	61926 F	*61928 C	12-16
36	61420 BV	61926 C	*61928 B	12-16
36-A	61420 BY			
37	61420 BT	61926 D	*61928 B	12-16
38	61920 L	61905 J-063	61924 J	7-18
39	61920 D	61926 D	*61928 B	12-16
40	63920 C	61926 R	*61928 R	7-20
76	L460 A	61926 A	*61928 A	11-18
77	L427 A	61926	*61928	11-18
78	61220 K	61905 H-063 or 083	61924 H	7-18
79	61920 T	61926 B	61928 M-073	6-10
80	L391 A	61926 B	63928 E	6-10
81	61920 T	61926 B	61928 M-053	6-10
82	L391 A	61926 B	61928 M-053	6-10
83	L347 A	61926 A	*61928 A	11-18
84	61920 U	L379 A	† L378 A	12-18
85	61220 K	L582 A	† L581 A	7-18
86	61420 CM	L582 A	† L581 A	7-18
86-A	61420 H			
88	61920 G	61926 G	61928 G-060	10-25
89	61920 K	61405 AC	61928 K-060	10-25
90	61920 G	61926 G	61928 G-050	7-20
91	61920 K	61405 AC	61928 K-050	7-20

* Needle hole in throat plate (.053 needle slot)

Needle hole in throat plate (.073 needle slot)

† Needle hole in throat plate (.063 needle slot)

NOTE: Style No. 88 is actually 29480 CM, Style No. 89 is actually 29480 CN, Style No. 90 is actually 29480 EN and Style No. 91 is actually 29480 EP.

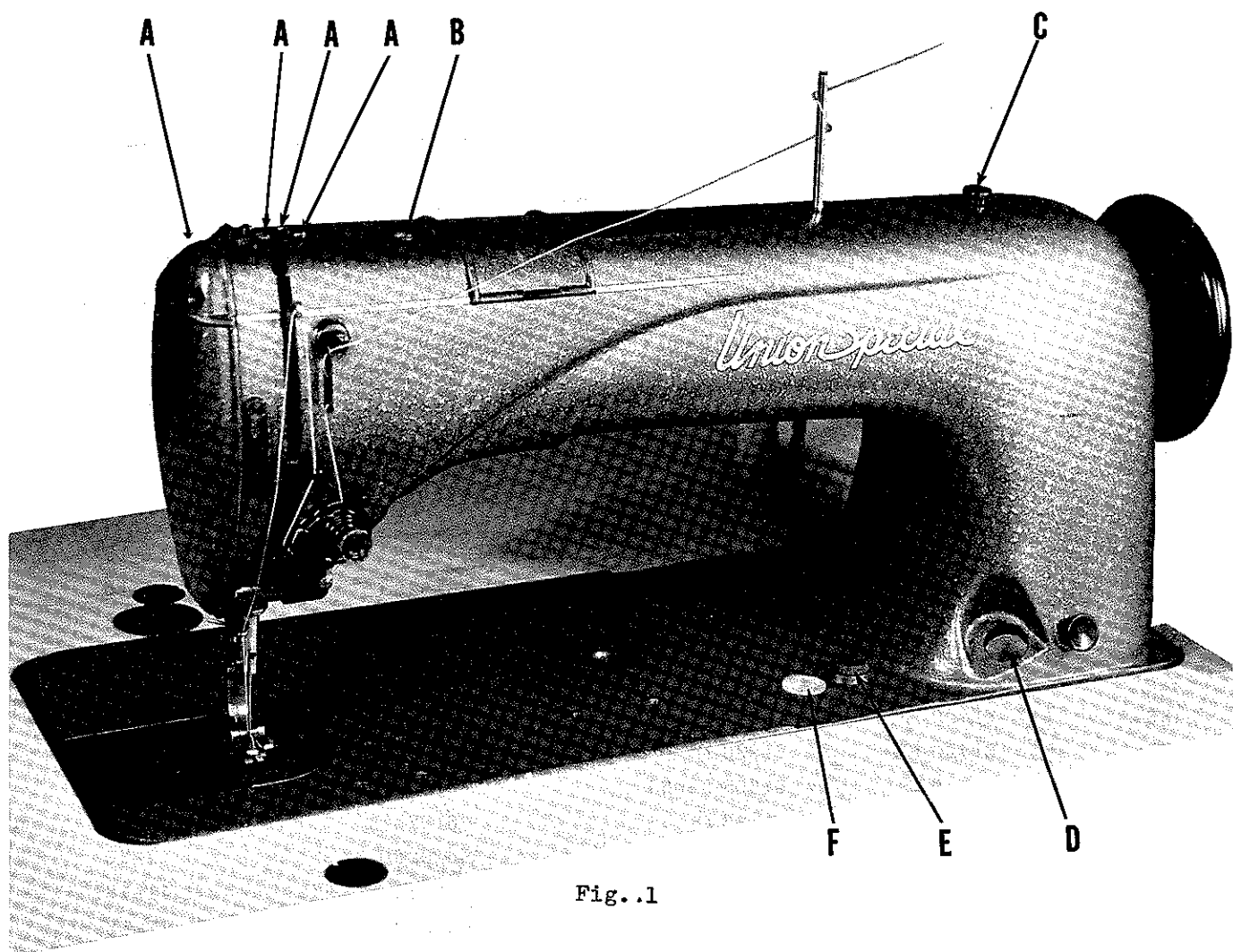

Fig..1

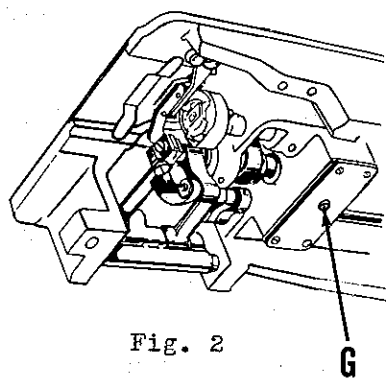

Fig. 2

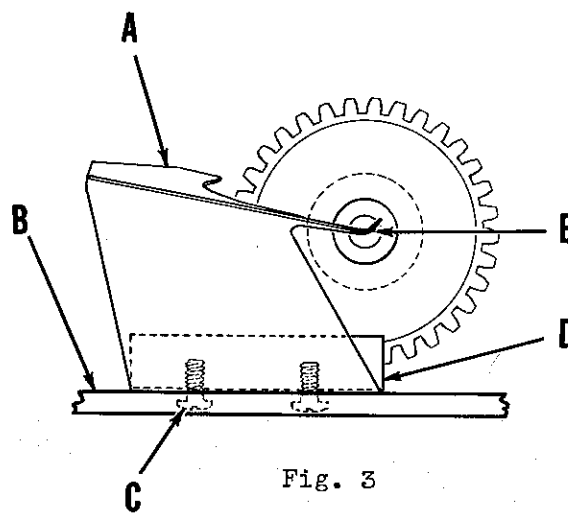

Fig. 3

TERMS

Prices are strictly net cash and subject to change without notice. All shipments are forwarded at the buyer's risk f. o. b. shipping point. Parcel Post shipments are insured unless otherwise directed. A charge is made to cover the postage and insurance.

LUBRICATION

Before starting to operate, be sure to remove the vent hole plug from the right side of the hook shaft gear case. This plug is used during shipment only, to prevent oil leakage through the vent hole. Then lubricate machine thoroughly in accordance with instructions and run slowly for several minutes to distribute the oil to the various parts. Full speed operation can then be expected without damage.

RECOMMENDED OILS

Use a straight mineral oil of a Saybolt viscosity of 90 to 125 seconds at 100° Fahrenheit in hook oil reservoir, feed driving shaft gear case, and hook shaft gear case. This is equivalent to Union Special oil specification No. 174.

Stainless water white straight mineral oil of the same viscosity as that described in the preceding paragraph, can be used in the hook oil reservoir. The stainless oil is Union Special specification No. 175.

Oils conforming to specification No. 174 or No. 175 may also be used in the manually oiled places.

On machines with serial number prior to No. 695863, the siphon which removes the excess oil from the sewing head must be primed. This is accomplished by removing the small screw located on the rear of the machine approximately 13/16 inch to the right of the center line of the presser bar and slightly below the presser foot hand lifter lever.

With a pump type oil can, force a liberal amount of oil into the screw hole, replacing the screw immediately. The siphon is now primed and will not require further attention unless the machine is stored either upside down or on end.

A full regular oil can may be used if a pump type can is not available.

Fill main reservoir through the oil cup (C) in the top of the machine. This oil level should be checked from time to time and kept between the lines on the gauge (D) in front of the machine.

With the needle bar at the top of its stroke, oil holes (A and B, Fig. 1) in the top of the machine twice daily.

The hook oil reservoir is drained when machine leaves factory and must be filled before starting to operate. It is filled at plug screw (E). Its level should be checked twice daily and kept between the lines of the gauge (F).

The hook shaft gear case is filled before shipment with a sufficient volume of oil to bring the level up to the plug screw hole (G, Fig. 2) in gear case cover when machine is tilted back against rest pin. Remove plug screw and check level of oil about every six months.

CAUTION! Do not use a compound oil in the hook oil reservoir, feeding drive shaft gear case, or hook shaft gear case, as these oils separate and froth.

Lubrication of the mechanism below the bed plate is automatically accomplished through the feed driving shaft which is tubular. Oil is introduced into the shaft at the gear end by means of an oil distributing plate (A, Fig. 3) which is secured to the large gear case cover (B) by means of two screws (C) and retaining block (D).

Should it ever become necessary to remove any of the parts from the gear case, it is imperative that the adjustment of the oil distributing plate be checked very carefully. This can be done by removing the large plug screw at right end of the gear housing and looking through the hole. The low point of the oil distributing plate must be even with or slightly below the center of the shaft (E) and just touching it. This is a very important adjustment, as the functioning of the automatic lubrication of the lower part of the machine depends upon it.

RECOMMENDED STYLE NUMBERS FOR SPECIFIC OPERATIONS

ARTICLE AND OPERATION	STYLE NUMBER	PRESSER FOOT	FEED DOG	THROAT PLATE	REMARKS
BAGS, Plastic Clothing, Shoe and Damper					
Binding	79	61920 T	61926 B	61928 M-073	
	80	L391 A	61926 B	#63928 E	
Hemming	33	61920 M	61926 E	*61928 C	
BLOUSES					
Runstitch collars	1	61920 L	61926 D	*61928 B	
Piece front facings and attach facings	1	61920 L	61926 D	*61928 B	
Hem right and left front facings	35	61920 M	61926 F	*61928 C	
Edgestitch right and left front facings and collar	83	L347 A	61926 A	*61928 A	
Attach collar	7	61920 J	61926	*61928	
COATS, Children's					
Make liner, make darts, join shoulders, set sleeves, close sleeve and sides	21-B	61920 L	61926 C	*61928 B	
Make collar and cuffs	21-B	61920 L	61926 C	*61928 B	
Seam, gore, join side seams, sew darts and plaits and join shoulders	27	61920 B	61926 C	*61928 B	
Attach lining to sleeves and front facings	27	61920 B	61926 C	*61928 B	
COATS, Ladies' Car					
Make lining, join sleeves, shoulders and side and back seams	1	61920 L	61926 D	*61928 B	
	37	61420 BT	61926 D	*61928 B	
Sew knit wristlets and collar to lining	8	61920 B	61905 J-063	61924 J	
Set pockets, make darts, sew knit facing to pocket backs	8	61920 B	61905 J-063	61924 J	
	21-B	61920 L	61926 C	*61928 B	
Set sleeves, close sleeves, attach collar, sew lining to front facings	8	61920 B	61905 J-063	61924 J	
	38	61920 L	61905 J-063	61924 J	
Edgestitch front and collar	33	61920 M	61926 E	*61928 C	

Needle hole in throat plate (.073 inch needle slot)

* Needle hole in throat plate (.053 inch needle slot)

CLASS 61900 (Page 2)

ARTICLE AND OPERATION	STYLE NUMBER	PRESSER FOOT	FEED DOG	THROAT PLATE	REMARKS
COATS, Boy's Sport Make lining, gore sleeves, set sleeves, close shoulders and side seams	1	61920 L	61926 D	*61928 B	
Make collar, gore sleeves, join shoulders and set pockets	21-B 27	61920 L 61920 B	61926 C 61926 C	*61928 B *61928 B	
Attach lining to front facings, seam back, close sleeves and side seam Edgestitch front and collar	21-B 33	61920 L 61920 M	61926 C 61926 E	*61928 B *61928 C	
COATS, Sport and Suit Seam sleeves, elbow seams, sleeve linings, seam back, side seams, front facings to lining, pocket facings	3-A 1 1	61920 S 61920 L 61920 L	61926 61926 D 61926 D	*61928 *61928 B *61928 B	
Hem yoke lining					
COATS, Men's Top and Overcoats Make lining and back yoke Close and cord elbow seams and underarm seams	1 21-A 21-C 21-B 21-A 21-B	61920 L 61920 S 61420 BU 61920 L 61920 S 61920 L	61926 D 61926 C 61926 C 61926 C 61926 C 61926 C	*61928 B *61928 B *61928 B *61928 B *61928 B *61928 B	
Sew lining and tape to vent					
Close back seam, side seams and cord stitch	21-A 21-B	61920 S 61920 L	61926 C 61926 C	*61928 B *61928 B	
Edgestitch front lapels and collar	36 36-A 21-B	61420 BV 61420 BY 61920 L	61926 C 61926 C 61926 C	*61928 B *61928 B *61928 B	

* Needle hole in throat plate (.053 inch needle slot)

CLASS 61900 (Page 3)

ARTICLE AND OPERATION	STYLE NUMBER	PRESSER FOOT	FEED DOG	THROAT PLATE	REMARKS
COATS, Town and Country Make quilted lining, gore sleeves, join shoulders, attach front facings to lining Quilt lining to undercollar Runstitch collar Runstitch pocket flaps Sew facings to pockets Attach welt to right and left fronts Attach pockets and flaps	12	61920 S	61905 K-073 or 083	61924 K	
	12-A	61920 A	61905 K-073 or 083	61924 K	
	12	61920 S	61905 K-073 or 083	61924 K	
	12-A	61920 A	61905 K-073 or 083	61924 K	
	12	61920 S	61905 K-073 or 083	61924 K	
	12-A	61920 A	61905 K-073 or 083	61924 K	
	12	61920 S	61905 K-073 or 083	61924 K	
	12-A	61920 A	61905 K-073 or 083	61924 K	
	12	61920 S	61905 K-073 or 083	61924 K	
	12-A	61920 A	61905 K-073 or 083	61924 K	
	12	61920 S	61905 K-073 or 083	61924 K	
	12-A	61920 A	61905 K-073 or 083	61924 K	
CORSETS Topstitch bra cups Attach lace and netting to bra cups Join cups Close stay pocket, join lining Join stay panel to front panel Join bodice to front Join elastic to gore panel Join back and yoke pieces Join front, back and yoke to gore panel	7-B	61920 P	61926	*61928	
	3	61920 B	61926	*61928	
	3	61920 B	61926	*61928	
	3	61920 B	61926	*61928	
	3	61920 B	61926	*61928	
	3	61920 B	61926	*61928	
	3	61920 B	61926	*61928	
	3	61920 B	61926	*61928	
	3	61920 B	61926	*61928	
	3	61920 B	61926	*61928	
	3	61920 B	61926	*61928	
	3	61920 B	61926	*61928	
DRESSES, House Attach front facings, join shoulders Set pockets Sew on zipper and bottom facings Attach rick-rack to fronts Attach facing to side Finish collar facing Sew in darts	1	61920 L	61926 D	*61928 B	
	7	61920 J	61926	*61928	
	18	61420 BT	61926	*61928	
	32	61920 R	61926	*61928	
	7	61920 J	61926	*61928	
	32	61920 R	61926	*61928	
	32	61920 R	61926	*61928	
	32	61920 R	61926	*61928	
	32	61920 R	61926	*61928	
	32	61920 R	61926	*61928	
	32	61920 R	61926	*61928	
	32	61920 R	61926	*61928	

* Needle hole in throat plate (.053 inch needle slot)

CLASS 61900 (Page 4)

ARTICLE AND OPERATION	STYLE NUMBER	PRESSER FOOT	FEED DOG	THROAT PLATE	REMARKS
DRESSES, Uniform					
Close end of collar	32	61920 R	61926	*61928	
Attach pockets	7	61920 J	61926	*61928	
Attach right and left front facings	1	61920 L	61926 D	*61928 B	
Sew collar down	7	61920 J	61926	*61928	
JACKETS					
Runstitch collar, cuffs and flaps	10	61920 A	61905 C-073	61924 C	
	10-A	61920 S	61905 C-073	61924 C	
	12-A	61920 A	61905 K-073 or 083	61924 K	
	12	61920 S	61905 K-073 or 083	61924 K	
Attach collar and cuffs	10	61920 A	61905 C-073	61924 C	
	10-A	61920 S	61905 C-073	61924 C	
	12-A	61920 A	61905 K-073 or 083	61924 K	
	12	61920 S	61905 K-073 or 083	61924 K	
Sew down collar and cuffs	13	61920 J	61905 E-073	61924 E	
	14	61920 J	61905 G-073 or 083	61924 G	
Gore sleeves, close sleeves, side seam, set sleeves, shoulder joining	11	61920 C	61905 C-073	61924 C	
	12-A	61920 A	61905 K-073 or 083	61924 K	
Set pockets	10	61920 A	61905 C-073	61924 C	
Hem bottom	10-A	61920 S	61905 C-073	61924 C	
	11	61920 C	61905 C-073	61924 C	
	12-A	61920 A	61905 K-073 or 083	61924 K	
Edge stitch fronts	10	61920 A	61905 C-073	61924 C	
	10-A	61920 S	61905 C-073	61924 C	
	12-A	61920 A	61905 K-073 or 083	61924 K	
	12-B	61320 P	61905 K-073 or 083	61924 K	
Attach zippers	20	61320 P	61905 E-073	61924 E	
	20-A	61420 BT	61905 E-073	61924 E	
	20-B	L440 A	61905 E-073	61924 E	
JACKET LININGS, Rayon and Sateen					
Shoulder joining, gore sleeves, piece back panel, close sides and sleeves, set sleeves	1	61920 L	61926 D	* 61928 B	
	25	61420 BT	61905 M-063	61924 E	

* Needle hole in throat plate (.053 inch needle slot)

CLASS 61900 (Page 5)

ARTICLE AND OPERATION	STYLE NUMBER	PRESSER FOOT	FEED DOG	THROAT PLATE	REMARKS
OUTERWEAR, Infant's					
Make lining, seam sleeves, sides and back	1	61920 L	61926 D	*61928 B	
Make collar flaps and topstitch	27	61920 B	61926 C	*61928 B	
Gore panels, topstitch panel, side seam	21-B	61920 L	61926 C	*61928 B	
Attach lining to front facings, attach collar, attach lining to bottom, close sleeves	21-B	61920 L	61926 C	*61928 B	
Attach waistband and stitch facings down	21-B	61920 L	61926 C	*61928 B	
PAJAMAS, Ladies' Woven					
Runstitch collar with piping	84	61920 U	L379 A	† L378 A	
Sew on front facings	1	61920 L	61926 D	*61928 B	
Attach pockets	7	61920 J	61926	*61928	
Attach waistband	7	61920 J	61926	*61928	
	7-A	L471 A	61926	*61928	
	7	61920 J	61926	*61928	
PAJAMAS, Men's					
Topstitch band	1	61920 L	61926 D	*61928 B	
Runstitch collar	3	61920 B	61926	*61928	
Attach pockets	7	61920 J	61926	*61928	
Attach collar	1	61920 L	61926 D	*61928 B	
Stitch down collar	9	61920 J	61905 J-063	61924 J	
	7	61920 J	61926	*61928	
Hem cuffs	78	61220 K	61905 H-063 or 083	61924 H	
PANTS, Work					
Front and hip pocket facings	21-B	61920 L	61926 C	*61928 B	
	7	61920 J	61926	*61928	
Set and cord front pockets	21-B	61920 L	61926 C	*61928 B	
Hang front pockets	22	61920 M	61926 C	*61928 B	
	21-B	61920 L	61926 C	*61928 B	
	23	61420 BU	61926 H	#61928 H or H-050	
Set hip pockets	78	61220 K	61905 H-063 or 083	61924 H	
	86	61420 CM	L582 A	† L581 A	
	86-A	61420 H	L582 A	† L581 A	

Needle hole in throat plate (.073 inch needle slot)
 † Needle hole in throat plate (.063 inch needle slot)
 * Needle hole in throat plate (.053 inch needle slot)

CLASS 61900 (Page 6)

ARTICLE AND OPERATION	STYLE NUMBER	PRESSER FOOT	FEED DOG	THROAT PLATE	REMARKS
PANTS, Work (Continued)					
Attach waistband	23	61420 BU	61926 H	#61928 H or H-050	
	23-A	61920 S	61926 H	#61928 H or H-050	
Topstitch left fly	1	61920 L	61926 D	*61928 B	
	23	61420 BU	61926 H	#61928 H or H-050	
	23-A	61920 S	61926 H	#61928 H or H-050	
Topstitch waistband	24	61420	61905 K-073 or 083	61924 K	
	23	61420 BU	61926 H	#61928 H or H-050	
	21-B	61920 L	61926 C	*61928 B	
PANTS, Boy's Dress					
Pocket facings, set front pockets	1	61920 L	61926 D	*61928 B	
Topstitch left fly	34	61920 B	61926 T	*61928	
Attach waistband to fronts, close seat seam	34	61920 B	61926 T	*61928	
Topstitch waistband	21	61920 P	61926 C	*61928 B	
	21-B	61920 L	61926 C	*61928 B	
PANTS, Dress and Slacks (Including Wash and Wear)					
Front and hip pocket facings	1	61920 L	61926 D	*61928 B	
	7	61920 J	61926	*61928	
Set and cord front pockets	2	61920 S	61926 D	*61928 B	
	1	61920 L	61926 D	*61928 B	
Attach right and left fly	1	61920 L	61926 D	*61928 B	
	21-B	61920 L	61926 C	*61928 B	
	17	61920 N	61926 D	*61928 B	
	2-A	L440 A	61926 D	*61928 B	
Attach waistband	1	61920 L	61926 D	*61928 B	
Side seam and inseam	2	61920 S	61926 D	*61928 B	
	1	61920 L	61926 D	*61928 B	
Topstitch left fly	18	61420 BT	61926	*61928	
* Needle hole in throat plate (.053 needle slot)					
# Needle hole in throat plate (.073 needle slot)					

CLASS 61900 (Page 7)

ARTICLE AND OPERATION	STYLE NUMBER	PRESSER FOOT	FEED DOG	THROAT PLATE	REMARKS
ROBES, Ladies'					
Bind collar and cuffs, front panels and bottoms	81	61920 T	61926 B	61928 M-053	
	82	L391 A	61926 B	61928 M-053	
Hem bottom	31	61420 AP	61926	*61928	
	31-A	61920 M	61926	*61928	
Sew collar down	9	61920 J	61905 J-063	61924 J	
	9-A	L471 A	61905 J-063	61924 J	
SHIRTS, Dress and Sport					
Runstitch collar	1	61920 L	61926 D	*61928 B	1/4 inch margin
	3	61920 B	61926	*61928	3/16 inch margin
Topstitch collar	4	61927 A	61926 A	*61928 A	1/16 inch margin
	4-A	61320 P	61926 A	*61928 A	1/8 inch margin
	4-B	61420 R	61926 A	*61928 A	3/32 inch margin
	4-C	61920 B	61926 A	*61928 A	3/16 inch margin
	1	61920 L	61926 D	*61928 B	1/4 inch margin
	2-B	61920 M	61926 D	*61928 B	1/4 inch margin
Attach collar band	5	61420 BT	61905 B-063 or 073 or 083	61924 B	
	5-A	L440 A	61905 B-063 or 073 or 083	61924 B	
Join shoulders (one operation)	2-B	61920 M	61926 D	*61928 B	
	6	61920 F	61905 F-063	61924 C	
Topstitch collar band	39	61920 D	61926 D	*61928 B	Attachment req.
	7	61920 J	61926	*61928	
	7-B	61920 P	61926	*61928	
Attach collar (first operation)	1	61920 L	61926 D	*61928 B	
Stitch down collar (second operation)	7	61920 J	61926	*61928	
	7-B	61920 P	61926	*61928	
Runstitch cuffs	2-B	61920 M	61926 D	*61928 B	
	1	61920 L	61926 D	*61928 B	
	3	61920 B	61926	*61928	
Topstitch cuffs	4	61927 A	61926 A	*61928 A	
	1	61920 L	61926 D	*61928 B	
Hem bottom	76	L460 A	61926 A	*61928 A	1/8 inch hem
Hem button front	2-B	61920 M	61926 D	*61928 B	

* Needle hole in throat plate (.053 inch needle hole)

CLASS 61900 (Page 8)

ARTICLE AND OPERATION	STYLE NUMBER	PRESSER FOOT	FEED DOG	THROAT PLATE	REMARKS
SHIRTS, Dress and Sport (Continued)					
Attach facing to left front	2-B	61920 M	61926 D	*61928 B	
Quilt collar band	1	61920 L	61926 D	*61928 B	
Set pockets	7	61920 J	61926	*61928	
Hem top of pockets	7	61920 J	61926	*61928	
Attach sleeve facings (continuous)	85	61220 K	L582 A	† L581 A	
SHIRTS, Knit Sport					
Attach front facings	8	61920 B	61905 J-063	61924 J	
Runstitch cuffs and collar	8	61920 B	61905 J-063	61924 J	
Attach and stitch down collar and cuffs	9	61920 J	61905 J-063	61924 J	
Set pockets	9	61920 J	61905 J-063	61924 J	
SHIRTS, Work and Heavy Sport					
Runstitch and top stitch collar and cuffs	11	61920 C	61905 C-073	61924 C	1/4 inch margin
	10	61920 A	61905 C-073	61924 C	1/4 inch margin
	12-A	61920 A	61905 K-073 or 083	61924 K	1/4 inch margin
Attach collar and cuffs	10	61920 A	61905 C-073	61924 C	
	12-A	61920 A	61905 K-073 or 083	61924 K	
Sew down collar and cuffs	13	61920 J	61905 E-073	61924 E	
	14	61920 J	61905 G-073 or 083	61924 G	
Attach collar band	15	61920 A	61905 B-063 or 073	61924 B	
	19	L310 A	61926	*61928	
Hem work shirts	77	L427 A	61926	*61928	
SHORTS AND SLACKS, Ladies'					
Attach facings to pockets	27	61920 B	61926 C	*61928 B	
Attach pockets	28-A	61920 A	61905 E-073	61924 E	
Attach and close pockets	27	61920 B	61926 C	*61928 B	
Attach elastic to waistband and finish band	26	61920 B	61905 C-073	61924 C	
	23	61420 BU	61926 H	#61928 H	or H-050
SHORTS, Men's Woven					
Form right and left fly	7	61920 J	61926	*61928	
	7-B	61920 P	61926	*61928	

* Needle hole in throat plate (.053 needle slot)

† Needle hole in throat plate (.063 needle slot)

Needle hole in throat plate (.073 needle slot)

CLASS 61900 (Page 9)

ARTICLE AND OPERATION	STYLE NUMBER	PRESSER FOOT	FEED DOG	THROAT PLATE	REMARKS
SHORTS, Men's Woven (Continued)					
French band hem	18	61420 BT	61926	*61928	
	2-B	61920 M	61926 D	*61928 B	
	3	61920 B	61926	*61928	
Attach waistband					
SHIRTS, Ladies' Cotton and Wool					
Make bows, sew lining to back, attach waistband and stitchdown band	1	61920 L	61926 D	*61928 B	
SLIPS, Cotton and Woven Synthetic Material					
Topstitch right and rear side panels	7-B	61920 P	61926	*61928	
SNOW SUITS, Children's Lined					
Make liner, attach sleeves, seat seam, side and center seam	1	61920 L	61926 D	*61928 B	
Attach hood, hood lining, cuffs and anklets					
Edgestitch fronts	12	61920 S	61905 K-073 or 083	61924 K	
	12-A	61920 A	61905 K-073 or 083	61924 K	
	33	61920 M	61926 E	*61928 C	
SWEATERS, Ladies' Cardigan					
Attach button and buttonhole facings	16	61920 R	61905 J-063	61924 J	
SWIM SUITS, Ladies' Woven					
Make shoulder straps	18	61420 BT	61926	*61928	
	18-A	61920 C	61926	*61928	
	30	61920 L	61926	*61928	
	30-A	61920 A	61926	*61928	
Close back seam					
SWIM SUITS, Ladies' Knit					
Sewing bra lining to fronts	28	61920 B	61905 E-073	61924 E	
	28-A	61920 A	61905 E-073	61924 E	
	29	61420 BT	61905 J-063	61924 J	
	1	61920 L	61926 D	*61928 B	
	18	61420 BT	61926	*61928	
Seam bra lining	1	61920 L	61926 D	*61928 B	
Make shoulder straps	1	61920 L	61926 D	*61928 B	
Join lining and trunks	1	61920 L	61926 D	*61928 B	
Close bra darts	1	61920 L	61926 D	*61928 B	
Close top of swim suit	1	61920 L	61926 D	*61928 B	

* Needle hole in throat plate (.053 needle slot)

The following is a numerical list of the parts used in this machine. Quantities, part numbers, and descriptions are given. Following the parts list are photographs of some of the major parts.

Amt.	Part No.	Description	Amt.	Part No.	Description	Amt.	Part No.	Description
1	18	Nut for 61984 C	1	660-209	TruArc Retain.	1	22597 A	Screw for 61445
1	PI18	Pin for oil siphon felt	1	660-225	Ring for 61261 A	1	22597 A	Screw for 62262
1	20	Washer for 61984 C	1	660-226	Needle Bearing for feed driv. eccen- tric conn. rod	1	22597 A	Screw for 61251 D
1	25 B	Screw for L347 A	1	660-226	Needle Bearing for 61984 B	1	22597 E	Set Screw for 61492 A
1	28 B	Screw for 61430 AP	1	660-257	Washer for 22730	1	22712 F	Screw for 61368 F
4	30-56 Blk.	Wood Plug for 61432	1	666-20	Oil Wick for head cover	4	22716 A	Screw for 61210 B
1	50-552 Blk.	Plug for feed driving shaft	1	666-104	Oil Wick for main shaft bushing housing	2	22716 A	Screw for 61230 A-1/8
1	50-558 Blk.	Plug for bed	1	666-126	Oil Wick for 61293	1	22716 B	Screw for 61414 C
1	50-567 Blk.	Oil Sight Gauge for 61394 AJ	1	666-127	Oil Wick for 61393 C	3	22716 H	Screw for 61411 A
1	50-568 Blk.	Oil Sight Gauge	1	666-139	Oil Wick for 61985	1	22729 A	Screw for 61377 N
1	50-692 Blk.	Air Vent for feed drive shaft	1	666-166	Oil Drain Jar	1	22730	PlugScr. for hook shaft gear case
1	57 WB	Nipper Spring Plate	1	666-173	Oil Wick for 29126 CZ, 61255 H, 61322 B	1	22738	Plug Screw for head
1	57 WC	Nipper Spring for 61900 A	1	666-174	Felt Wick for 61994 B	1	22738	Screw for oil siphon
1	57 WD	Nipper Spr. Screw	1	666-196	Oil Wick for 61993 D	2	22738	Screw for 61430 P
2	HA61 D	Screw for 61264	1	666-201	Felt Plug for siphon	1	22738	Screw for 61994 B
2	HA61 D	Screw for 61264 A	1	666-209	Felt Disc for siphon	1	22742	Screw for 61414 A
2	69 FD	Screw for 21661 D, 21664	1	719	Screw for 61437 C	1	22743	Plug Screw for feed driving shaft
2	69 FD	Screw for 21665	2	8372 A	Washer for 61391 C	1	22757 C	Screw for 61255 H
1	73 A	Screw for 61430 AJ	1	9937	Nut for 22874 F	1	22758 B	Screw for 61267
1	HA73 B	Screw for 61430 AN	1	14077	Nut for 22504 H	1	22764 B	Time Spot Screw for 61437 A
1	73 C	Screw for 61430 CB	1	15037 A	Nut for 22845 D	2	22768	Screw for feed dog
2	74 E	Plug Screw for 61982	1	15438 C	Nipper Spring for 61900 B	1	22768 A	Needle Set Screw
1	88	Screw for 161	1	15872 F	Spring for 61366 A	1	22768 B	Screw for 61959
2	88	Screw for 61242	1	21212	Oil Siphon Connect. Locking Ring	1	22775	Screw for presser foot
1	88	Screw for 61438 A	1	21388	Wrench	1	22775 A	Screw for feed dog height adjustment
1	88 B	Screw for 51773	1	21393 E	Drip Pan	1	22799 M	Hand Lifter Screw Pin
1	88 D	Screw for 61439 A	1	21393 F	Oil Drain Clamp Spring	1	22802 A	Screw for 61449 F
2	89	SpotScr. for 61244	1	21660 C	Knee Lifter Assembly	1	22817 A	Stud for 61468
1	89	SpotScr. for 63434 C	1	21661 D	Knee Lifter Rocker Shaft Stop (69 FD)	1	22839	Screw for 61985 F
1	89	SpotScr. for 61492	1	21661 P	Knee Lifter Rocker Shaft	1	22840 A	Adj. Screw for 61420 H, 61420 CM, 61920 T
2	90	Screw for 61336 Y	2	21662 C	Knee Lifter Hanger	1	22845 D	Feed Link Stud
2	91 A	Screw for 61273	1	21663 C	Knee Lifter Plate Rod	1	22845 G	Screw for 61449 E
1	93	Screw for 61414 A	1	21664	Knee Lifter Plate (69 FD)	2	22846 Q-16	Screw for 61374, 61374 A
1	93 A	Screw for 61246 A	2	21665	Knee Lifter Rocker Shaft Connection (69 FD)	1	22863 B	Adj. Screw for Tension Assembly
1	95	Screw for 61949	2	21665 C	Knee Lifter Rocker Shaft Connection (69 FD)	1	22874 F	Screw for 61468
2	95	Screw for 29126 CZ	1	22504 H	Screw for 61985 D	1	22878	Screw for 61377 Y
2	95	Screw for 61984 A	1	22528	Screw for 61439	1	22880	Screw for 61449 E
1	96	SpotScr. for 61949	1	22539 D	Plug Screw for base	2	22884	Screw for 61260 A
1	96 A	Screw for 61341 C	1	22562 B	Screw for 61255	2	22884	Screw for 61360
2	109	Tension Disc for 29475 AA or 29475 AC	1	22564 B	Screw for 61437 C	2	22884	Screw for 61360 G
1	138	Screw for 62282 B	1	22564 B	Screw for 62271 F	1	22890	Screw, left thread, for 61466 A
1	161	Collar for 61445 (88)	2	22564 E	Screw for 61414 C, 61415	1	22892	Screw for 61458
1	226	Screw for 61430 BB	1	22564 F	Screw for 61413 G	2	22892 E	Screw for 61236 G
1	L310 A	Presser Foot	1	22565 D	Adj. Screw for L391 A, 61920 C	1	22894 E	Screw for 61985 A
1	L347 A	Presser Foot	1	22565 E	Adjusting Screw for 61420 BU, 61420 BV, 61920 L, 61920 M, 61920 N	2	22894 J	Screw for 61443
2	376	Screw for throat plate	1	22569 B	Screw for 61982	1	22894 U	Screw for 61391 C
1	L378 A	Throat Plate (376)	3	22569 C	Screw for 61394 Z	1	22894 V	Screw for 61391 C
1	L379 A	Feed Dog (22768)	3	22569 H	Set Scr. for 61208 B	1	22894 W	Screw for 61391 C
1	L391 A	Presser Foot	1	22570 A	Screw for 61271	1	22894 W	Set Screw for 61959
1	L427 A	Presser Foot	4	22570 A	Screw for 61282 A	2	22894 AB	Screw for 61421 A
1	L440 A	Presser Foot	6	22570 A	Screw for 61382 J	1	29126 BS	Feed Drive Eccentric Assem.
1	L460 A	Presser Foot	2	22574	Screw for 61394 Q	1	29126 CZ	Needle Feed Drive Eccentric Assem.
1	L471 A	Presser Foot	1	22574	Screw for 61421 A	1	29474 G	Rotating Hook Assembly
2	531	Screw for 61248 H	2	22574	Screw for 61321 J	1	29475 AA	Tension Post Assembly for 61900 B
1	L581 A	Throat Plate (376)	2	22585 A	Screw for 61351 J	1	29475 AC	Tension Post Assembly for 61900 A
1	L582 A	Feed Dog (22768)	2	22596 D	Adj. Screw for 61391 C	1	29475 AP	Take-up Thread Wire Assembly
1	605	Screw for 61430 AK	2			1	29480 CM	Automatic Chain Cutter Assembly, 7/32 inch margin to right of needle
1	643-194	Oil Tube for 61982	2					
1	652 B-20	Lock Washer for 61366 C	2					
1	660-142	Spring Collar Pin for 61368 A	3					
1	660-168	Knee Pad for 21664	2					

Amt.	Part No.	Description	Amt.	Part No.	Description	Amt.	Part No.	Description
1	29480 CN	Automatic Chain Cutter Assembly, 9/32 inch margin to right of needle	1	61282 A	Hook Shaft Gear Housing Cover (22570 A)	1	61360	Main Shaft Driving Gear (22884)
1	51242 M	Washer for 22802 A	1	61282 D	Gasket for 61382 J	1	61360 G	Feed Driving Shaft Collar (22884)
1	51294 N	Oil Siphon Connection	1	61282 E	Gasket for 61282 A	1	61366 C	Lifter Lever Extension Stud (652 B-20)
1	51430 F	Nut for 22565 E	1	61292 G	Tens. Release Pin	1	61368	Lifter Lever Connecting Rod for 61368 A
1	51430 F	Nut for 22565 D	1	61292 H	Tension Release Washer	1	61368 A	Lifter Lever Extension Stud and Lifter Lever Connecting Rod, complete (61366 C, 61368)
1	51430 F	Nut for 22840 A	1	61293	Oil Tube	1	61368 F	Lifter Lever Bell Crank Roller (22712 F)
1	51773	Collar for 61985 B (88 B)	2	61293 N	Plug for bed	1	61374	Machine Hinge Plate, right (22846 Q-16)
1	51930	Spring for L347A, L440A, L471A, 61220 K, 61920A, 61920B, 61920D, 61920E, 61920 S	1	61320 P	Presser Foot	1	61374 A	Machine Hinge Plate, left (22846 Q-16)
1	60038 G	Bearing Sleeve for 61984 C	1	61321 J	Handwheel for 61421 (22574)	2	61375	Machine Hinge Stud
1	61208 B	Rotating Hook (22569 N)	1	61321 L	Washer for 61421	4	61376 G	Felt Pads for table tops
1	61210 B	Hook Thread Deflector (22716 A)	1	61322 B	Main Shaft	1	61377 Y	Bobbin Winder Pulley
1	61212	Bobbin for 29474 G	2	61330	Shank for L310 A, L347A, L391A, L440 A, 61420AP, 61920 A, 61920 F, 61920 W	1	61378	Machine Rest Pin
1	61216	Bobbin Case Latch Hinge Pin	1	61330 B-29	Hinge Pin for 61220 K, 61920 B	1	61382 J	Feed Driving Gear Housing Cover (22570 A)
1	61216 N	Bobbin Case Latch Spring	2	61330 B-29	Hinge Pin for 61920 G	1	61391 C	Main Shaft Counterweight (22894 U, 22894 V, 22894 W)
1	61220 K	Presser Foot	1	61330 B-31	Hinge Pin for L347A, L391A, L440A, L471A, 61420BT, 61920D, 61920R, 61920U	1	61392 F-9	Tension Spring for 29475 AC
1	61230 A-1/8	Scroll for L460 A (22716 A)	1	61330 B-35	Hinge Pin for 61420 H, 61420CM, 61920A, 61920C, 61920F, 61920 L, 61920S, 61920 T	1	61392 F-14	Tension Spring for 29475 AA
1	61230 C	Scroll Pin for L460 A	1	61330 B-39	Hinge Pin for L310A	1	61393 C	Oil Tube for take-up lever (666-127)
1	61230 S	Shank for 61920 D	2	61330 B-39	Hinge Pin for 61920K	1	61394 L	Oil Reservoir Securing Screw
1	61230 AK	Spring for 61920 U	1	61330 Y	Hinge Pin for 61920R, 61920S	1	61394 M	Gasket for 61394 AC
1	61233 N	Feed Lift Link	1	61330 Z	Bottom for presser foot L391 A	1	61394 P	Oil Distributing Plate
1	61236	Feed Rocker	1	61330 AC	Bottom for presser foot L347 A, L440A	1	61394 Q	Oil Distributing Plate Retaining Block (22570 A)
1	61236 G	Feed Rocker Shaft (22894 E)	1	61330 AD	Shank for 61220 K	2	61394 R	Gasket for 61394 Q, 61994 A
1	61242	Hook Shaft Collar (88)	1	61330 AH	Shank for 61920T	1	61394 Z	Hook Oil Reservoir End Cover (22569 C)
1	61244	Hook Shaft Pinion Gear (89)	1	61330 AM	61420 H, 61420BT, 61920C, 61420CM	1	61394 AA	Gasket for 61394 Z
1	61245 G	Stitch Regulating Plunger Locking Insert	1	61330 AN	Bottom right section for presser foot L471 A	1	61394 AC	Hook Oil Reservoir Filler Hole Plug Screw
1	61246 A	Stitch Regulating Plunger Lever (93 A)	1	61330 AP	Yielding Section for L471 A	1	61394 AE	Main Reservoir Oil Filler Cup
2	61248 H	Stitch Regulating Shaft Collar (531)	2	61336 U	Shank for L471 A	2	61394 AF	Hook Oil Reservoir Gasket, left
1	61251 D	Take-up Lever Pin (22597 A)	1	61336 Y	Feed Rocker Shaft Bushing	1	61394 AJ	Hook Oil Reservoir Hook Shaft Oil Metering Insert
1	61252	Take-up Lever Link	1	61340 C	Feed Rocker Oil Wick (90)	1	61396 F	Feed Dog for 29480 CN
1	61252 J	Take-up Lever Crank Pin for 61900 A	1	61341 C	Hook Shaft Hook Shaft Bushing, left (96 A)	1	61405 AC	Hook, Thread Retainer, Thread Deflector and Bobbin Case Holder Assembly for 29474 G
1	61255	Needle Bar Connection (22562 B)	1	61341 D	Hook Shaft Bushing, right	1	61407 B	Hook, Thread Retainer, and Thread Deflector Assembly
1	61255 H	Needle Bar Link (22757 C)	2	61341 G	Hook Shaft Oil Seal Washer	1	61411 A	Hook Thread Retainer (22716 H)
1	61256 G	Presser Spring Washer	1	61341 J	Thrust Washer for 61244	1	61413 E	Bobbin Case Assembly for 29474 G
1	61260 A	Feed Driving Shaft Gear (22884)	1	61348 A	Stitch Regulating Shaft	1	61413 F	Bobbin Case for 61413 E
1	61261 A	Feed Driving Shaft Intermediate Gear	1	61351 C	Thrust Washer for 61351 Q	1	61413 G	Bobbin Case Eyelet (22564 F)
1	61263	Bushing for 61261 A	1	61351 J	Frame Take-up Thread Eyelet (22585 A)	1	61414	Bobbin Case Eyelet (22564 F)
1	61264	Intermediate Gear Shaft Collar, right (HA61 D)	1	61351 K	Needle Bearing Roller	1		Bobbin Case Holder for 29474 G
1	61264 A	Intermediate Gear Shaft Collar, left (HA61 D)	2	61351 Q	Take-up Lever Assembly	1		
1	61265	Hand Lifter (22799M)	1	61356	Presser Spring			
1	61267	Lifter Lever Link (22758 B)	1					
1	61267 G	Lifter Lever Spring Pin	1					
1	61271	Frame Needle Thread Eyelet (22570 A)	38					
1	61272	Needle Thread Guide Pin	1					
1	61273	Bed Slide Spring (91 A)	1					

Amt.	Part No.	Description	Amt.	Part No.	Description	Amt.	Part No.	Description
1	61414 A	Bobbin Case Holder Positioning Finger (93, 22742)	1	61438 A	Feed Driving Eccentric Conn. Rod (88, 22564 B)	1	61905 M-063	Feed Dog (22768)
1	61414 C	Tension Spring for 61413 E (22716 B, 22564 E)	1	61439	Feed Dog Holder (22528)	1	61917	Needle Bar
1	61415	Bobbin Case Latch (22564 E)	1	61439 A	Feed Dog Holder Support (88 D)	1	61920 A	Presser Foot
1	61415 A	Bobbin Case Latch Lever	1	61443	Hook Shaft Driving Gear (22894 J)	1	61920 B	Presser Foot
1	61420	Presser Foot	1	61445	Stitch Regulating Plunger (22597 A)	1	61920 C	Presser Foot
1	61420 H	Presser Foot	1	61447	Stitch Regulating Plunger Lever Spring	1	61920 D	Presser Foot
1	61420 R	Presser Foot	1	61449	Stitch Regulating Eccentric (61449 A)	1	61920 E	Presser Foot
1	61420 AP	Presser Foot	1	61449 A	Cork Friction Disc for 61449	1	61920 F	Presser Foot
1	61420 BT	Presser Foot	1	61449 B	Stitch Regulating Thrust Spring	1	61920 G	Presser Foot for 29480 CM
1	61420 BU	Presser Foot	1	61449 E	Stitch Regulating Pawl Collar (22845 G, 22880)	1	61920 J	Presser Foot
1	61420 BV	Presser Foot	1	61449 F	Stitch Regulating Pawl (22802 A, 51242 M)	1	61920 K	Presser Foot for 29480 CN
1	61420 BY	Presser Foot	1	61449 H	Stitch Length Indicator Window	1	61920 L	Presser Foot
1	61420 CM	Presser Foot	1	61451 C	Thrust Washer for take-up lever	1	61920 M	Presser Foot
1	61421	Handwheel, complete for #1 "V" or round belt (22537)	1	61453	Tension Take-up Spring	1	61920 N	Presser Foot
1	61421 A	Pulley Hub (22894 AB)	1	61457	Presser Bar	1	61920 P	Presser Foot
1	61430 P	Scroll for L427 A (22738)	1	61457 B	Presser Spring Regulator	1	61920 R	Presser Foot
1	61430 Y	Bottom for 61420 BT	1	61457 C	Bushing, presser bar, lower	1	61920 S	Presser Foot
1	61430 AA	Shank for 61420 BU, 61420 BV, 61920 L, 61920 M	1	61458	Presser Bar Connection (22892)	1	61920 T	Presser Foot
1	61430 AB	Bottom for 61420 BU	1	61466 A	Lifter Lever (15872 F, 22890)	1	61924 B	Throat Plate (376)
1	61430 AC	Bottom for 61420 BV	1	61468	Lifter Lever Bell Crank (22817 A, 22874 F)	1	61924 C	Throat Plate (376)
1	61430 AE	Shank for 61920 K	1	61470	Needle Thd. Guide	1	61924 E	Throat Plate (376)
1	61430 AG	Shank for 61920 G	1	61477 M	Bobbin Winder, complete	1	61924 G	Throat Plate (376)
1	61430 AH	Spring for 61430 CA	1	61490	Main Shaft Bush. and Housing, right	1	61924 H	Throat Plate (376)
1	61430 AJ	Spring for 61430 AL (73 A)	1	61490 A	Main Shaft Bush. for 61490	1	61924 J	Throat Plate (376)
1	61430 AK	Spring Guide for 61920 G, 61920 K (605)	1	61492	Tension Post (89)	1	61924 K	Throat Plate (376)
1	61430 AL	Yielding Section for 61920 G, 61920 K	1	61492 A	Tension Post Socket (22597 E, 22863 B)	1	61926	Feed Dog (22768)
1	61430 AN	Chain Cutter, marked "G", for 61920 K	1	61494 N	Priming Tube Grommet	1	61926 A	Feed Dog (22768)
1	61430 AP	Chain Cutter, marked "H", for 61920 G	1	61494 U	Washer for 61394 L	1	61926 B	Feed Dog (22768)
1	61430 AS	Bottom for 61420 BY	1	61902	Bed Slide	1	61926 C	Feed Dog (22768)
1	61430 AT	Shank for 61420 BY	1	61905 B-063	Feed Dog (22768)	1	61926 D	Feed Dog (22768)
1	61430 BB	Spring for 61420 BU, 61420 BV, 61420 BY, 61920 L, 61920 M (226)	1	61905 B-073	Feed Dog (22768)	1	61926 E	Feed Dog (22768)
1	61430 CA	Adjustment Slide for 61920 G, 61920 K	1	61905 B-083	Feed Dog (22768)	1	61926 F	Feed Dog (22768)
1	61430 CB	Adjusting Pin for 61920 G, 61920 K (73 C)	1	61905 C-073	Feed Dog (22768)	1	61926 G	Feed Dog for 29480 CM
1	61432	Feed Driving Shaft for 61900 A (22743)	1	61905 E-073	Feed Dog (22768)	1	61926 H	Feed Dog (22768)
1	61432 A	Feed Driving Shaft for 61900 B (22743)	1	61905 F-063	Feed Dog (22768)	1	61926 R	Feed Dog (22768)
1	61432 B	Feed Driving Shaft Bushing, right	1	61905 G-073	Feed Dog (22768)	1	61926 T	Feed Dog (22768)
1	61432 C	Feed Driving Shaft Bushing, left	1	61905 G-083	Feed Dog (22768)	1	61927 A	Presser Foot
1	61432 D	Feed Driving Shaft Oil Retaining Bushing, right	1	61905 H-063	Feed Dog (22768)	1	61928	Throat Plate (376)
1	61432 E	Feed Driving Shaft Oil Retaining Bushing, left	1	61905 H-083	Feed Dog (22768)	1	61928 A	Throat Plate (376)
1	61434 G	Washer for feed bar link stud	1	61905 J-063	Feed Dog (22768)	1	61928 B	Throat Plate (376)
1	61437 A	Feed Driving Eccentric Timing Collar (22764 B)	1	61905 K-073	Feed Dog (22768)	1	61928 C	Throat Plate (376)
1	61437 B	Feed Driving Eccentric Pivot Pin	1	61905 K-083	Feed Dog (22768)	1	61928 H	Throat Plate (376)
1	61437 C	Feed Driving Eccentric Retain. Housing (719, 22564 B)	1	61905 K-083	Feed Dog (22768)	1	61928 G-050	Throat Plate
1	61437 E	Feed Driving Eccentric for 29126 BS	1	61905 K-083	Feed Dog (22768)	1	61928 G-060	Throat Plate for 29480 CM
							61928 H-050 or 073	Throat Plate
							61928 K-050	Presser Foot
							61928 K-060	Presser Foot for 29480 CN
							61928 M-053	Presser Foot
							61928 M-073	Presser Foot
							61928 R	Presser Foot
							61930 A	Bottom for 61920 A
							61930 B	Bottom for 61920 B
							61930 C	Bottom for 61920 C
							61930 D	Bottom for 61920 L
							61930 E	Bottom for 61920 M
							61930 J	Shank for 61920 B
							61930 K	Bottom for 61920 D
							61930 L	Yielding Section for 61920 D
							61930 M	Bottom, marked "U", for 61920 G
							61930 N	Bottom, marked "v", for 61920 K
							61930 P	Shank for 61920 N
							61930 R	Bottom for 61920 N
							61930 S	Bottom for 61920 S
							61930 T	Bottom for 61920 R
							61930 U	Shank for 61920 T
							61949	Stitch Length Indicator (95, 96)
							61952	Take-up Lever Crank Pin for 61900 B

Amt.	Part No.	Description	Amt.	Part No.	Description	Amt.	Part No.	Description
1	61953 A	Thread Take-up Wire	1	61985 A	Needle Bar Frame Pivot Stud (22894 E)	1	61993 B	Oil Tube for main shaft bushing, left
1	61959	Presser Bar Guide (22768 B, 22894 W)	1	61985 B	Needle Bar Frame Rock Shaft	1	61993 D	Oil Tube for needle bar and take-up lever
1	61982	Head Cover (74 E, 643-194, 22569 B)	1	61985 D	Needle Bar Frame Rock Shaft	1	61994	Oil Siphon
1	61982 B	Top Cover			Connecting Link (22504 D)	1	61994 A	Oil Siphon Bracket
2	61982 C	Top Cover Hinge Pin			Needle Bar Frame Rock Shaft Driving Lever (22517)	1	61994 B	Oil Siphon Tube (22738)
4	61982 D	Top Cover Hinge Pin			Bushing for needle bar frame rocker shaft, left	1	62262	Intermediate Gear Shaft (22597 A)
1	61984	Needle Feed Drive Eccentric (95)	1	61985 F	Needle Bar Frame Rock Shaft Driving Lever (22517)	1	62271 F	Needle Thread Nipper Base
1	61984 A	Needle Bearing Retaining Collar (95)	1	61985 G	Bushing for needle bar frame rocker shaft, left	1	62282 B	Spring for 61982 B (138)
1	61984 B	Needle Feed Drive Eccentric Bearing	1	61985 H	Bushing for needle bar frame rocker shaft, right	1	63434 C	Feed Bar (89, 22775, 22845)
1	61984 C	Needle Feed Drive Eccentric Connecting Stud (18, 20)	1	61985 J	Needle Bar Frame Pivot Adjusting Bushing	2	63435 A	Feed Bar Shaft
1	61985	Needle Bar Frame (666-139)				1	63494 B	Plastic Plug
						1	63920 C	Presser Foot
						1	63928 E	Throat Plate (376)

NOTE: Numbers in parentheses following parts' description indicate the screws, nuts, etc., used to attach or hold these parts. For a more detailed description on the presser feet, throat plates and feed dogs, refer to the copy opposite the picture plates showing these items.

ROTATING HOOK ASSEMBLY

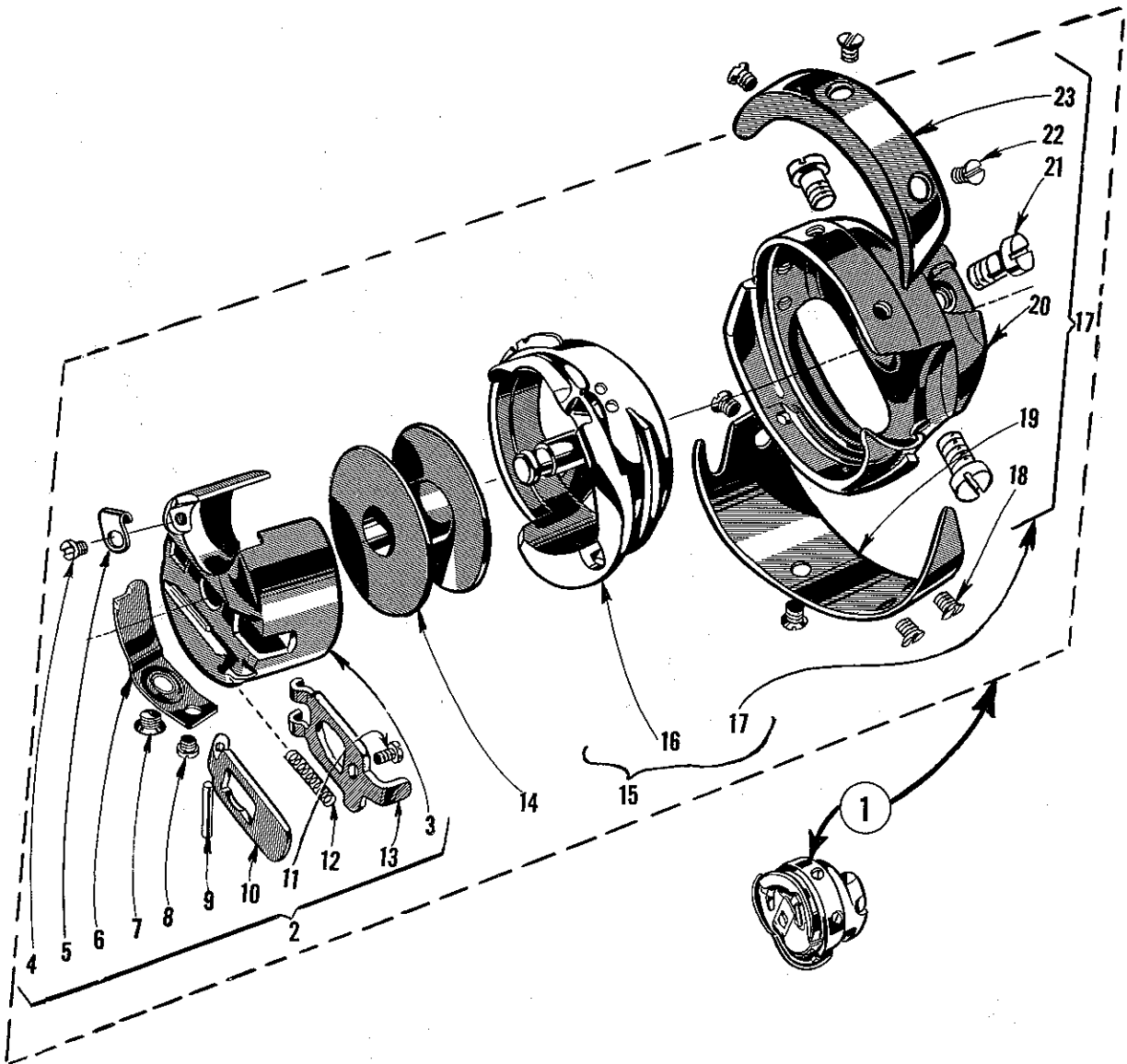

Ref. No.	Part No.	Description	Amt. Req.
1	29474 G	Rotating Hook Assembly -----	1
2	61413 E	Bobbin Case Assembly -----	1
3	61413 F	Bobbin Case -----	1
4	22564 F	Screw -----	1
5	61413 G	Eyelet -----	1
6	61414 C	Bobbin Case Tension Spring -----	1
7	22716 B	Tension Regulating Screw -----	1
8	22564 E	Screw -----	1
9	61216	Bobbin Case Latch Hinge Pin -----	1
10	61415 A	Bobbin Case Latch Lever -----	1
11	22564 E	Stop Screw -----	1
12	61216 N	Bobbin Case Latch Spring -----	1
13	61415	Bobbin Case Latch -----	1
14	61212	Bobbin -----	1
15	61407 B	Hook, Thread Deflector, Thread Retainer and Bobbin Case Holder Assembly -----	1
16	61414	Bobbin Case Holder -----	1
17	61407 C	Hook, Thread Deflector and Thread Retainer Assembly -----	1
18	22716 A	Screw -----	4
19	61210 B	Hook Thread Deflector -----	1
20	61208 B	Rotating Hook -----	1
21	22569 H	Set Screw -----	3
22	22716 H	Screw -----	3
23	61411 A	Hook Thread Retainer -----	1

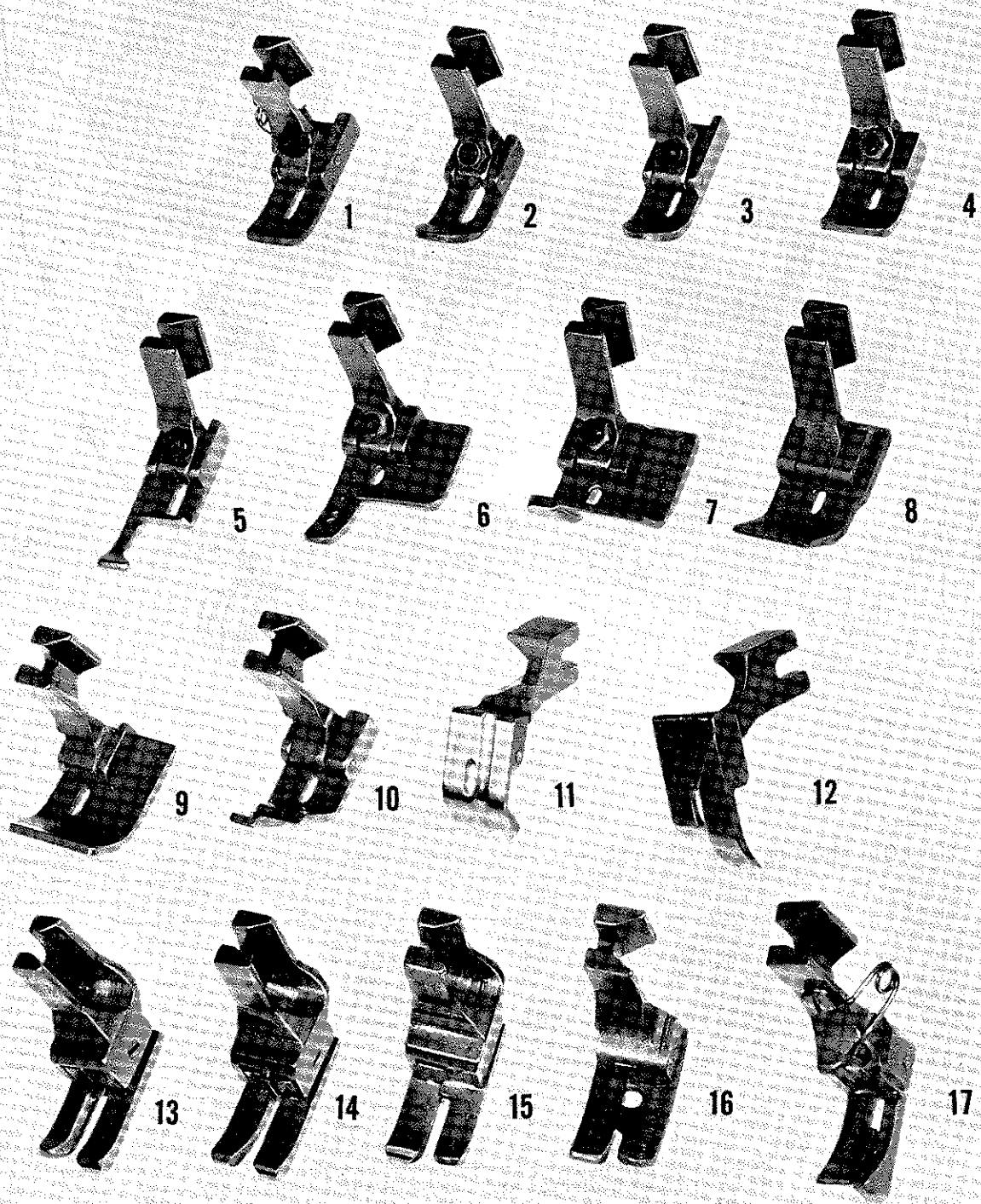

PRESSER FEET FOR 61900 A & B

<u>Ref. No.</u>	<u>Part No.</u>	<u>Description</u>
1	61920 M	Presser Foot, hinged bottom, hinge pin set back 1/8 inch more than standard, tilt adjusting screw in shank, return spring on side, bottom 1/2 inch wide over-all, for use on wash and wear material. For Style Nos. 2 B, 22, 31 A, 33, 35.
2	L391 A	Presser Foot, hinged bottom, tilt adjusting screw in shank, bottom 15/32 inch wide over-all. For Style Nos. 80, 82.
3	61420 BT	Presser Foot, hinged bottom, tilt adjusting screw in shank, bottom 7/16 inch wide over-all. For Style Nos. 5, 18, 20 A, 25, 29, 37.
4	61920 C	Presser Foot, hinged bottom, tilt adjusting screw in shank, bottom 17/32 inch wide over-all, for plain seaming and edging operations on medium to heavy weight work. For Style Nos. 11, 18 A.
5	61920 T	Presser Foot, hinged bottom, tilt adjusting screw in shank, bottom 17/32 inch wide over-all, for use with right angle binder. For Style Nos. 79, 81.
6	61420 H	Presser Foot, hinged bottom, tilt adjusting screw in shank, bottom 7/8 inch wide over-all, for attaching sleeve facings to shirts. For Style No. 86 A.
7	61420 CM	Presser Foot, hinged bottom, tilt adjusting screw in shank, bottom 7/8 inch wide over-all, flat bottom with guide on left hand side of toe, for facing operations. For Style No. 86.
8	61420 AP	Presser Foot, hinged bottom, high turned up toe with notch on right side, bottom 5/8 inch wide over-all. For Style No. 31.
9	61220 K	Presser Foot, hinged spring bottom, bottom 3/4 inch wide over-all, for facing operations. For Style Nos. 78, 85.
10	61920 F	Presser Foot, hinged spring bottom, bottom 17/32 inch wide over-all, step on left side of toe, for shoulder joining on shirts. For Style No. 6.
11	61920 U	Presser Foot, hinged bottom, 3/32 inch wide groove in bottom, bottom 15/32 inch wide over-all, for piping operations. For Style No. 84.
12	L310 A	Presser Foot, hinged bottom, bottom relieved to the right and in back of needle hole, bottom 9/16 inch wide over-all, for hemming operation where turn is required. Similar to 61420 BN except lengthened needle hole. For Style No. 19.
13	61920 J	Presser Foot, hinged bottom, split bottom with yielding section on right side, bottom 1/2 inch wide over-all, for setting pockets and edge stitching operations. Similar to 61420 A except lengthened needle hole. For Style Nos. 7, 9, 13, 14.
14	61420	Presser Foot, hinged bottom, split bottom with both sides yielding, bottom 17/32 inch wide over-all, for second operation of attaching collars to shirts. For Style No. 24.
15	61920 P	Presser Foot, hinged bottom, split bottom with yielding section on left side, bottom 1/2 inch wide over-all, for edge stitching operations. Similar to 61420 B except lengthened needle hole. For Style Nos. 7 B, 21.
16	L471 A	Presser Foot, hinged bottom, split bottom with yielding section on left side, bottom 17/32 inch wide over-all, for edge stitching operations. Similar to 61320 AH except lengthened needle hole. For Style Nos. 7 A, 9 A.
17	L347 A	Presser Foot, rigid bottom, split bottom with yielding section on right side, 1/32 inch margin, bottom 11/32 inch wide over-all, for edge stitching operations. For Style No. 83.



1

2

3

4

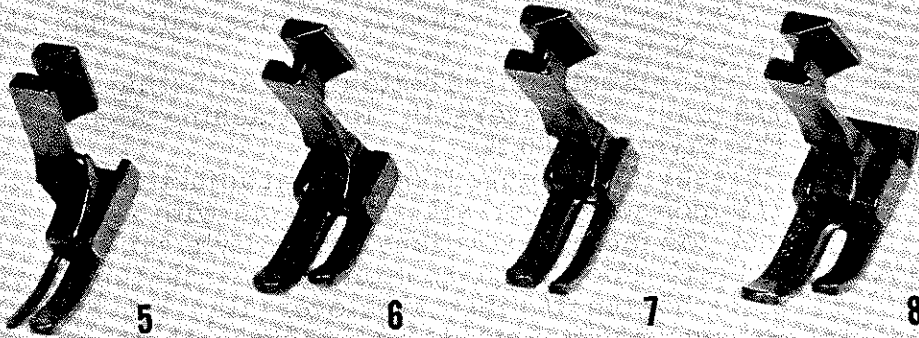

5

6

7

8

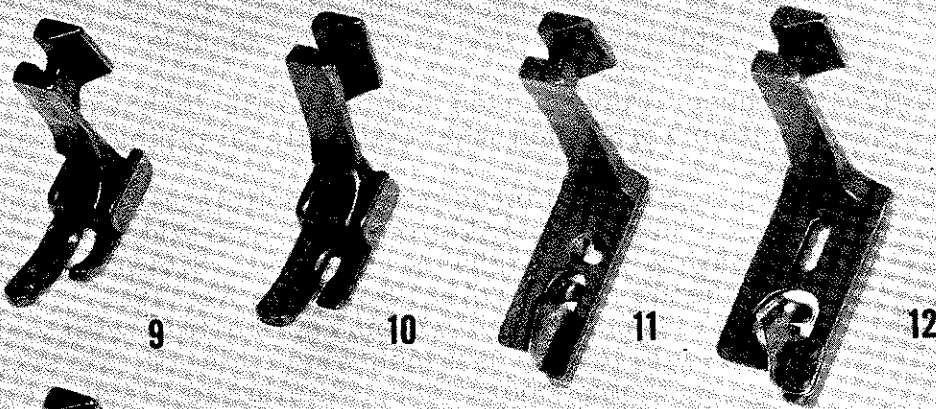

9

10

11

12

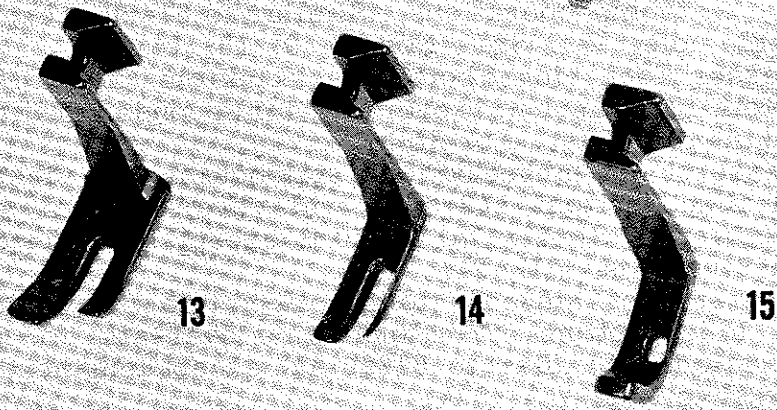

13

14

15

PRESSER FEET FOR 61900 A & B

<u>Ref. No.</u>	<u>Part No.</u>	<u>Description</u>
1	61420 BY	Presser Foot, hinged bottom, spring on left side for raising toe, 1/8 inch margin to right of needle, bottom 11/32 inch wide over-all, for sewing on wash and wear material. For Style No. 36 A.
2	61920 L	Presser Foot, hinged bottom, tilt adjusting screw in shank, spring on left side for raising toe, 1/4 inch margin to right of needle, bottom 1/2 inch wide over-all, for sewing on wash and wear material. For Style Nos. 1, 21 B, 30, 38.
3	61420 BV	Presser Foot, hinged bottom, tilt adjusting screw in shank, spring on left side for raising toe, 1/4 inch margin to right of needle, bottom 1/2 inch wide over-all, for sewing on wash and wear material. Similar to 61920 L except toe longer in front. For Style No. 36.
4	61420 BU	Presser Foot, hinged bottom, tilt adjusting screw in shank, spring on left side for raising toe, 5/16 inch margin to right of needle, bottom 5/8 inch wide over-all, for sewing on wash and wear material. For Style Nos. 21 C, 23.
5	61920 N	Presser Foot, hinged bottom, tilt adjusting screw in shank, 7/64 inch margin to left and 1/4 inch margin to right of needle, bottom 23/64 inch wide over-all, for attaching pants flies and zippers. For Style No. 17.
6	61920 A	Presser Foot, hinged bottom, spring under shank for raising toe, 1/4 inch margin to right of needle, bottom 17/32 inch wide over-all, for plain seaming and edging operations. For Style Nos. 10, 12 A, 15, 28 A, 30 A.
7	61920 B	Presser Foot, hinged bottom, spring under shank for raising toe, 3/16 inch margin to right of needle, bottom 7/16 inch wide over-all, for plain seaming and edging operations. For Style Nos. 3, 4 C, 8, 26, 27, 28, 34.
8	61920 S	Presser Foot, hinged bottom, spring under shank for raising toe, 1/4 inch margin to right of needle, bottom 17/32 inch wide over-all, for plain seaming operations. For Style Nos. 2, 3 A, 10 A, 12, 21 A, 23 A.
9	L440 A	Presser Foot, hinged bottom, spring under shank for raising toe, 13/64 inch margin to right of needle, bottom 15/32 inch wide over-all, for plain seaming on light weight material. For Style Nos. 2 A, 5 A, 20 B.
10	61920 R	Presser Foot, hinged bottom, 13/64 inch margin to right of needle, bottom 15/32 inch wide over-all, for plain seaming on light weight material. For Style Nos. 16, 32.
11	L460 A	Presser Foot, rigid bottom, for producing a 1/8 inch hem. For Style No. 76.
12	L427 A	Presser Foot, rigid bottom, for producing a 5/32 inch hem. For Style No. 77.
13	61320 P	Presser Foot, rigid bottom, 13/64 inch margin to right of needle, bottom 1/2 inch wide over-all. For Style Nos. 4 A, 12 B, 20.
14	61420 R	Presser Foot, rigid bottom, 3/32 inch margin to right of needle, bottom 5/16 inch wide over-all. For Style No. 4 B.
15	61927 A	Presser Foot, rigid bottom, 1/16 inch margin to right of needle, bottom 17/64 inch wide over-all. For Style No. 4.



4

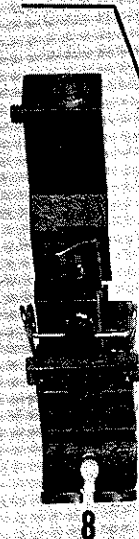

8

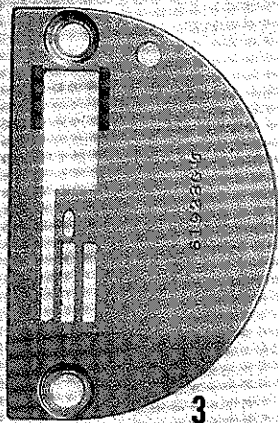

3

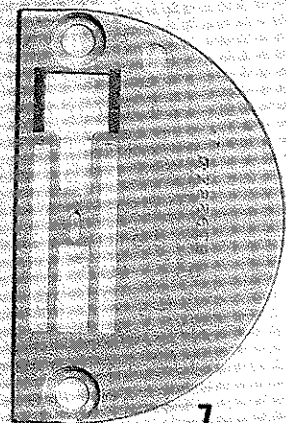

7

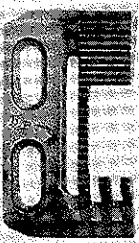

2



9

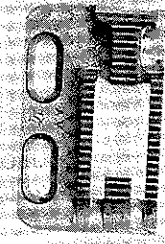

6

1

5

PRESSER FOOT AND AUTOMATIC CHAIN CUTTER ASSEMBLIES

<u>Ref. No.</u>	<u>Part No.</u>	<u>Description</u>
1	29480 CM	Automatic Chain Cutter Assembly, with narrow cutter, 7/32 inch margin to right of needle, consists of one each Nos. 61920 G, 61926 G, 61928 G-060. For Style No. 88.
-	29480 EN	Automatic Chain Cutter Assembly, with narrow cutter, 7/32 inch margin to right of needle, consists of one each Nos. 61920 G, 61926 G, 61928 G-050. For Style No. 90.
2	61926 G	Feed Dog, marked "BB", 22 teeth per inch.
3	61928 G-060	Throat Plate, .060 inch wide needle slot and .125 inch thick. For use with Feed Dog No. 61926 G on Style No. 88.
-	61928 G-050	Throat Plate, .050 inch wide needle slot and .125 inch thick. For use with Feed Dog No. 61926 G on Style No. 90.
4	61920 G	Presser Foot, hinged compensating bottom, with chain cutter, 7/32 inch margin to right of needle, bottom 7/16 inch wide over-all. For Style Nos. 88, 90.
5	29480 CN	Automatic Chain Cutter Assembly, with wide cutter, 9/32 inch margin to right of needle, consists of one each Nos. 61405 AC, 61920 K, 61928 K-060. For Style No. 89.
-	29480 EP	Automatic Chain Cutter Assembly, with wide cutter, 9/32 inch margin to right of needle, consists of one each Nos. 61405 AC, 61920 K, 61928 K-050. For Style No. 91.
6	61405 AC	Feed Dog, marked "AV", 22 teeth per inch.
7	61928 K-060	Throat Plate, .060 inch wide needle slot and .125 inch thick. For use with Feed Dog No. 61405 AC on Style No. 89.
-	61928 K-050	Throat Plate, .050 inch wide needle slot and .125 inch thick. For use with Feed Dog No. 61405 AC on Style No. 91.
8	61920 K	Presser Foot, hinged compensating bottom, with chain cutter, 9/32 inch margin to right of needle, bottom 19/32 inch wide over-all. For Style Nos. 89, 91.
9	61920 D	Presser Foot, hinged bottom, split bottom with yielding section on left side, 1/32 inch margin to left of needle, bottom 5/8 inch wide over-all, for shoulder joining, sleeve facing and similar operations on sport and dress shirts. For Style No. 39.

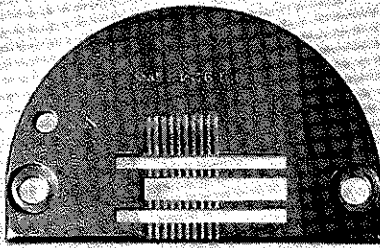

1

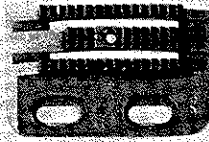

A

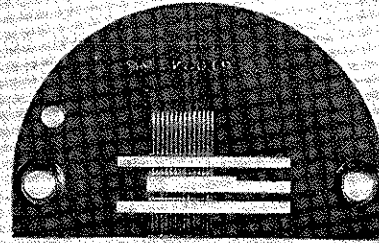

2



A

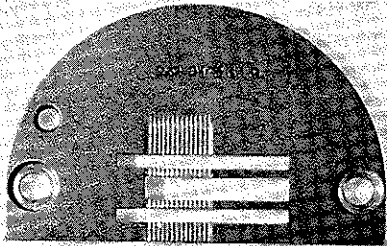

3

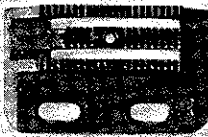

A



B

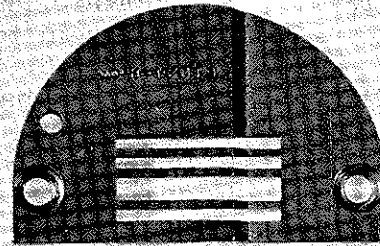

4

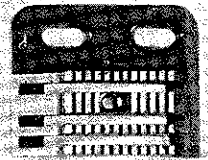

A

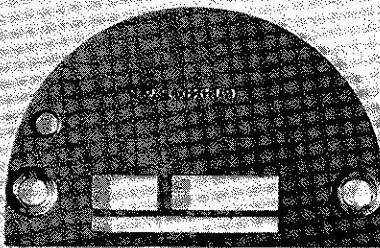

5



A

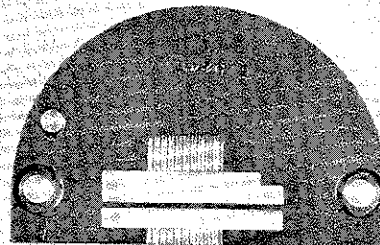

6



A



B

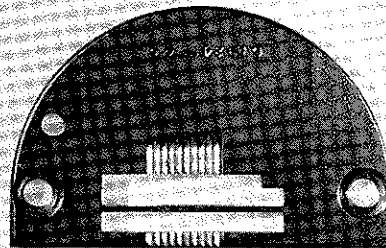

7



A

THROAT PLATE - FEED DOG COMBINATIONS FOR 61900 A & B
NEEDLE HOLE IN FEED DOG

<u>Ref. No.</u>	<u>Part No.</u>	<u>Description</u>
1	61924 K	Throat Plate, .125 inch thick, beveled at front and serrations on top cut 20 teeth per inch. For use with Feed Dog No. 61905 K-073 or 61905 K-083 on Style Nos. 12, 12 A, 12 B and 24.
1A	61905 K-073	Feed Dog, 16 teeth per inch, .073 inch diameter needle hole.
	61905 K-083	Feed Dog, 16 teeth per inch, .083 inch diameter needle hole.
2	61924 J	Throat Plate, .085 inch thick and serrations on top cut 32 teeth per inch. For use with Feed Dog No. 61905 J-063 on Style Nos. 8, 9, 9 A, 16, 29 and 38.
2A	61905 J-063	Feed Dog, 22 teeth per inch, .063 inch diameter needle hole.
3	61924 C	Throat Plate, .085 inch thick and serrations on top cut 32 teeth per inch. For use with Feed Dog No. 61905 F-063 on Style No. 6 and with Feed Dog No. 61905 C-073 on Style Nos. 10, 10 A, 11 and 26.
3A	61905 F-063	Feed Dog, 22 teeth per inch, .063 inch diameter needle hole.
3B	61905 C-073	Feed Dog, 16 teeth per inch, .073 inch diameter needle hole.
4	61924 H	Throat Plate, .203 inch thick at back and .109 inch thick at front. For use with Feed Dog No. 61905 H-063 or 61905 H-083 on Style No. 78.
4A	61905 H-063	Feed Dog, 16 teeth per inch, .063 inch diameter needle hole.
	61905 H-083	Feed Dog, 16 teeth per inch, .083 inch diameter needle hole.
5	61924 B	Throat Plate, .085 inch thick. For use with Feed Dog Nos. 61905 B-063, 61905 B-073 or 61905 B-083 on Style Nos. 5, 5 A and 15.
5A	61905 B-063	Feed Dog, 22 teeth per inch, .063 inch diameter needle hole.
	61905 B-073	Feed Dog, 22 teeth per inch, .073 inch diameter needle hole.
	61905 B-083	Feed Dog, 22 teeth per inch, .083 inch diameter needle hole.
6	61924 E	Throat Plate, .085 inch thick and serrations on top cut 20 teeth per inch. For use with Feed Dog No. 61905 M-063 on Style No. 25 and with Feed Dog No. 61905 E-073 on Style Nos. 13, 20, 20 A, 20 B, 28 and 28 A.
6A	61905 M-063	Feed Dog, 22 teeth per inch, .063 inch diameter needle hole.
6B	61905 E-073	Feed Dog, 16 teeth per inch, .073 inch diameter needle hole.
7	61924 G	Throat Plate, .125 inch thick, beveled at front and serrations on top cut 20 teeth per inch. For use with Feed Dog No. 61905 G-073 or 61905 G-083 on Style No. 14.
7A	61905 G-073	Feed Dog, 16 teeth per inch, .073 inch diameter needle hole.
	61905 G-083	Feed Dog, 16 teeth per inch, .083 inch diameter needle hole.

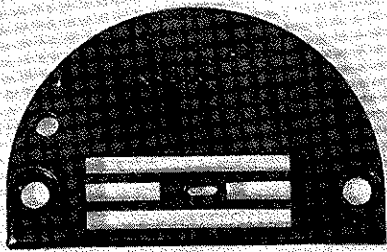

1



A

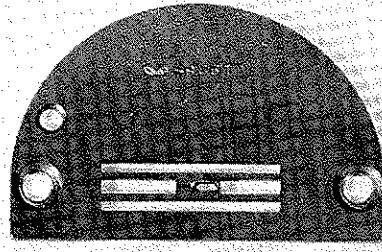

2

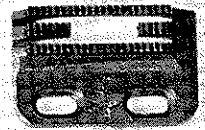

A



B

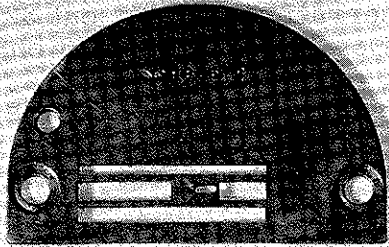

3



A



B

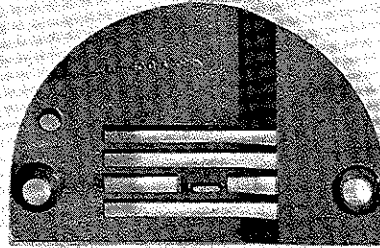

4

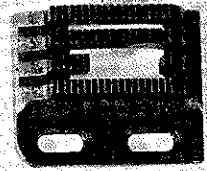

A

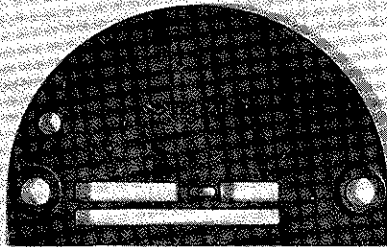

5



A



B

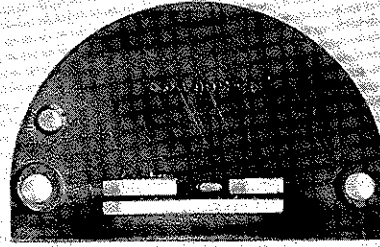

6



A

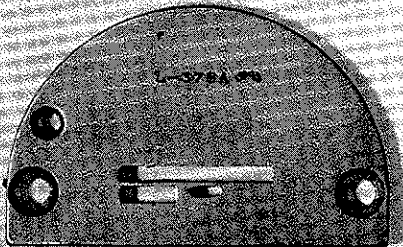

7



A

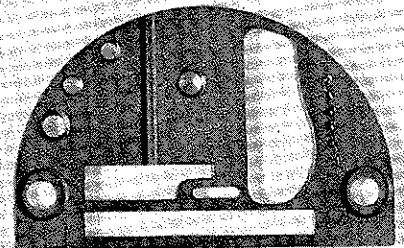

8

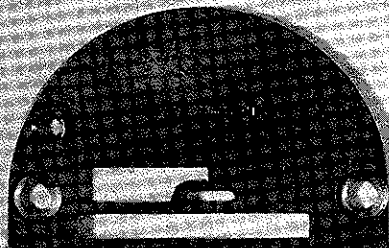

9



A

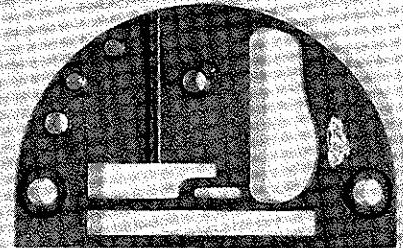

10

THROAT PLATE - FEED DOG COMBINATIONS FOR 61900 A & B
NEEDLE HOLE IN THROAT PLATE

Ref. No.	Part No.	Description
1	61928 H	Throat Plate, .073 inch wide needle slot and .125 inch thick. For use with Feed Dog No. 61926 H on Styles Nos. 23 and 23 A.
-	61928 H-050	Throat Plate, .050 inch wide needle slot and .125 inch thick. For use with Feed Dog No. 61926 H on Style Nos. 23 and 23 A.
1A	61926 H	Feed Dog, 16 teeth per inch.
2	61928	Throat Plate, .053 inch wide needle slot and .085 inch thick. For use with Feed Dog No. 61926 T on Style No. 34 and with Feed Dog No. 61926 on Style Nos. 3, 3 A, 7, 7 A, 7 B, 18, 18 A, 19, 30, 30 A, 31, 31 A, 32 and 77.
2A	61926 T	Feed Dog, 16 teeth per inch.
2B	61926	Feed Dog, 22 teeth per inch.
3	61928 B	Throat Plate, .053 inch wide needle slot and .085 inch thick. For use with Feed Dog No. 61926 D on Style Nos. 1, 2, 2 A, 2 B, 17, 37 and 39, and with Feed Dog No. 61926 C on Style Nos. 21, 21 A, 21 B, 21 C, 22, 27, 36 and 36 A.
3A	61926 D	Feed Dog, 22 teeth per inch.
3B	61926 C	Feed Dog, 16 teeth per inch.
4	L581 A	Throat Plate, .063 inch wide needle slot, .226 inch thick at back and .109 inch thick at front. For use with Feed Dog No. L582 A on Style Nos. 85, 86 and 86 A.
4A	L582 A	Feed Dog, 22 teeth per inch.
5	61928 C	Throat Plate, .053 inch wide needle slot and .085 inch thick. For use with Feed Dog No. 61926 E on Style No. 33 and with Feed Dog No. 61926 F on Style No. 35.
5A	61926 E	Feed Dog, 16 teeth per inch.
5B	61926 F	Feed Dog, 22 teeth per inch.
6	61928 A	Throat Plate, .053 inch wide needle slot and .085 inch thick. For use with Feed Dog No. 61926 A on Style Nos. 4, 4 A, 4 B, 4 C, 76 and 83.
6A	61926 A	Feed Dog, 22 teeth per inch.
7	L378 A	Throat Plate, .063 inch wide needle slot and .085 inch thick. For use with Feed Dog No. L379 A on Style No. 84.
7A	L379 A	Feed Dog, 22 teeth per inch.
8	61928 M-073	Throat Plate, .073 inch wide needle slot and .085 inch thick. For use with Feed Dog No. 61926 B on Style No. 79.
9	63928 E	Throat Plate, .073 inch wide needle slot and .085 inch thick. For use with Feed Dog No. 61926 B on Style No. 80.
10	61928 M-053	Throat Plate, .053 inch wide needle slot and .085 inch thick. For use with Feed Dog No. 61926 B on Style Nos. 81 and 82.
10A	61926 B	Feed Dog, 16 teeth per inch.

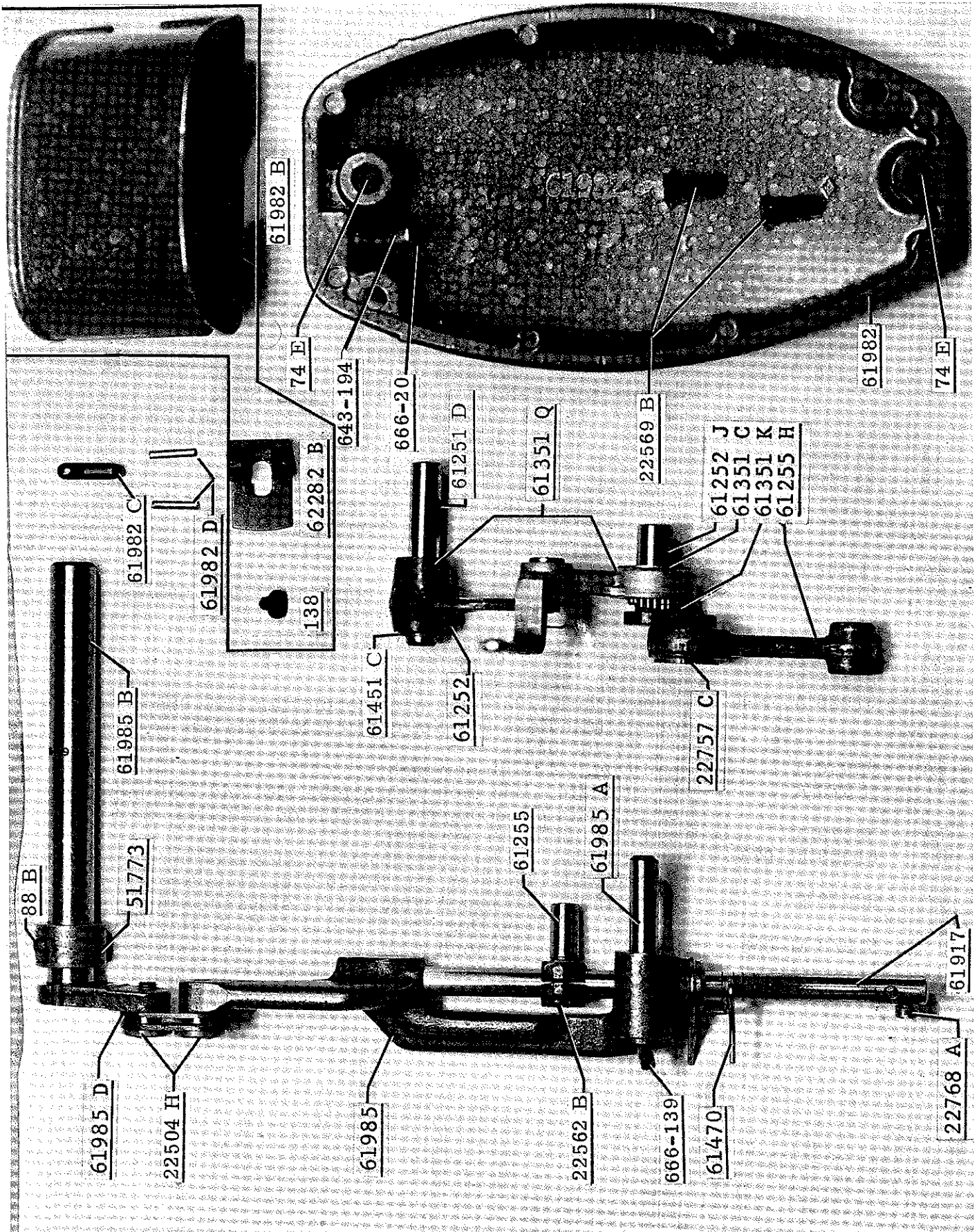

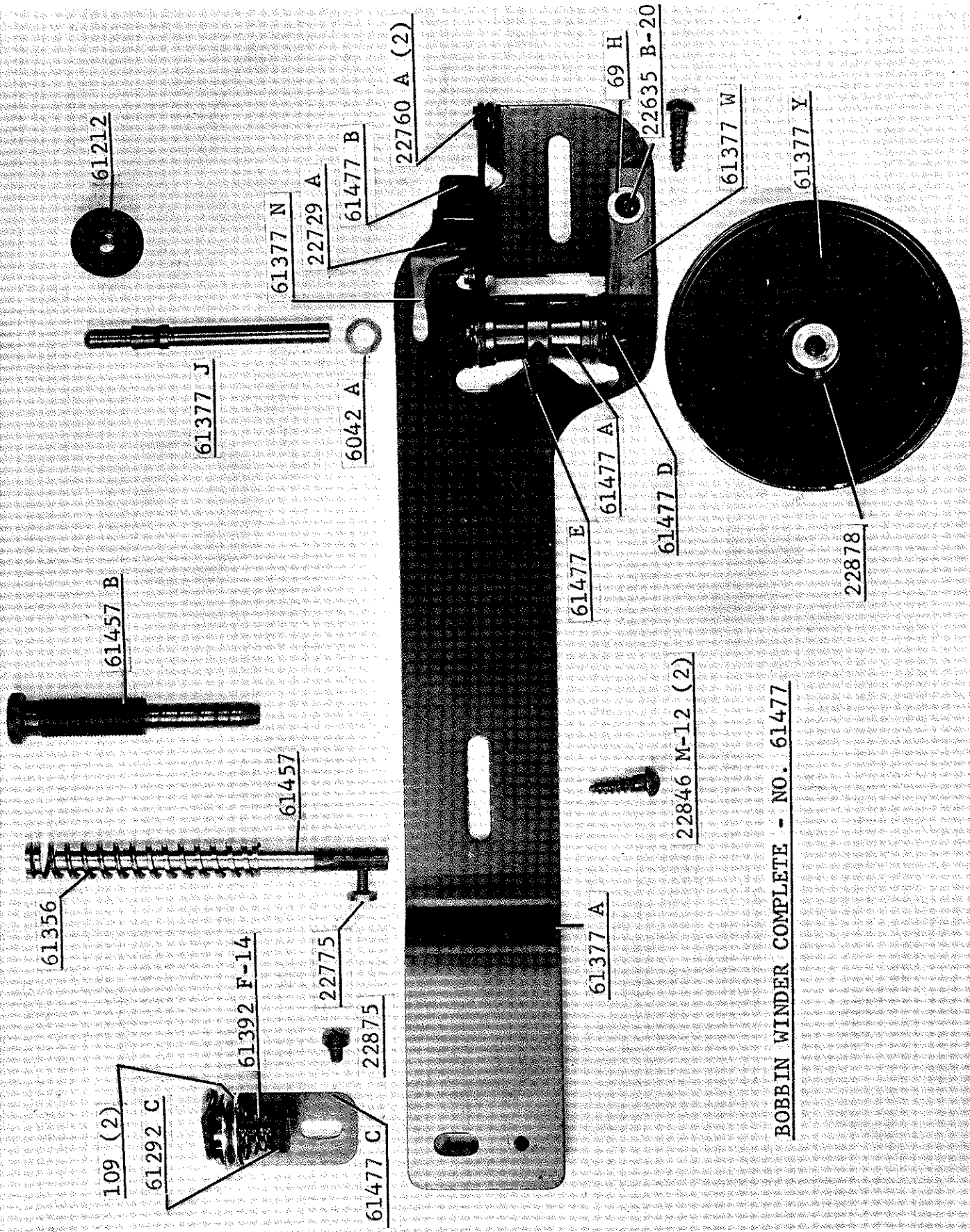

BOBBIN WINDER COMPLETE - NO. 61477

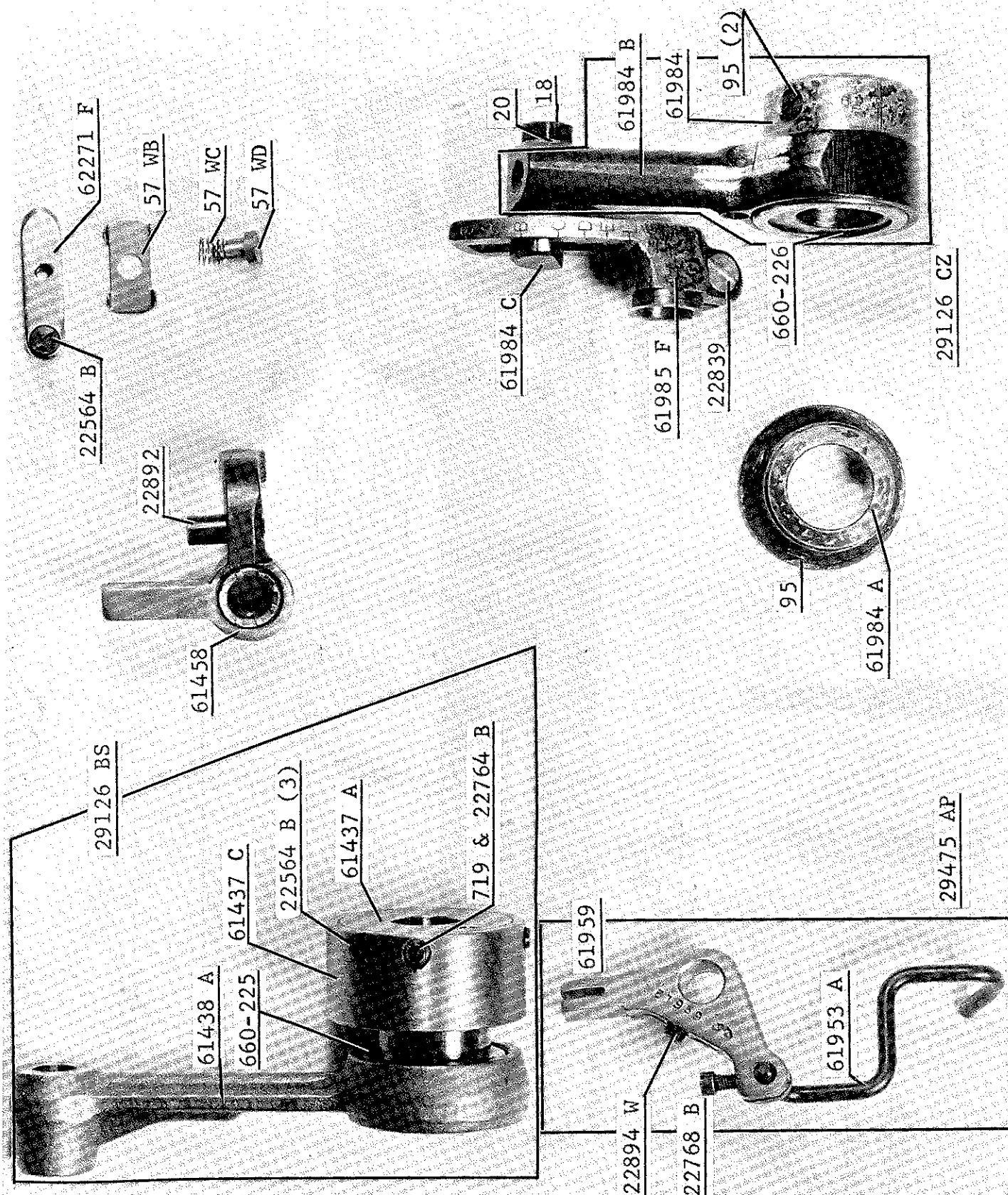

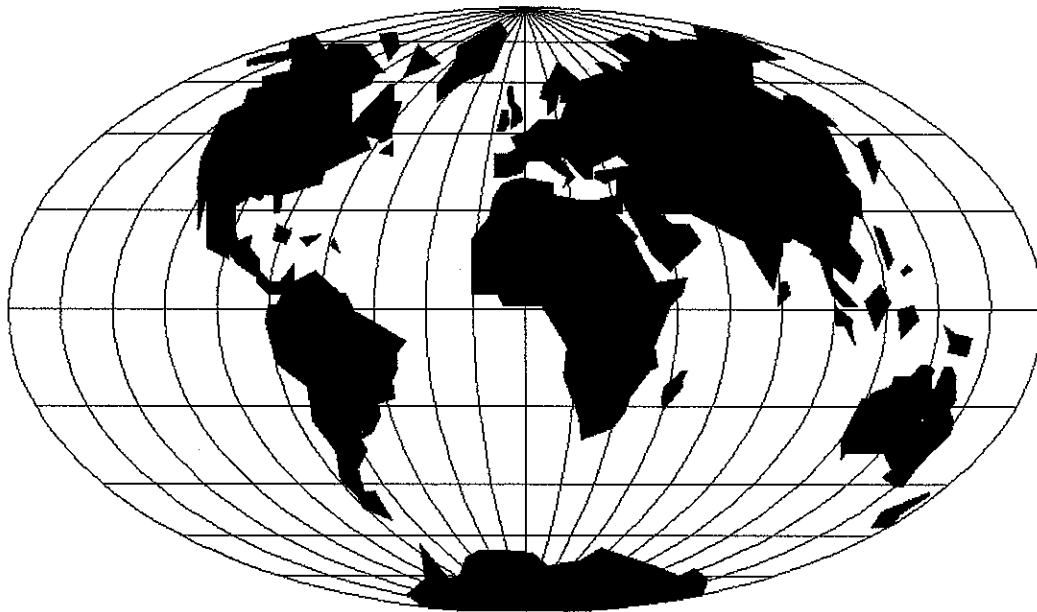

WORLDWIDE SALES AND SERVICE

Union Special Corporation maintains sales and service facilities throughout the world. These offices will aid you in the selection of the right sewing equipment for your particular operation. Union Special Corporation representatives and service technicians are factory trained and are able to serve your needs promptly and efficiently. Whatever your location, there is a qualified representative to serve you.

Corporate Office: One Union Special Plaza
Huntley, IL 60142
Phone: 847•669•5101
Fax: 847•669•1096

European Distribution Center: Union Special GmbH
Raiffeisenstrasse 3
D-71696 Möglingen, Germany
Tel: 49•07141•247•0
Fax: 49•7141•247•100

Brussels, Belgium
Charlotte, N.C.
El Paso, TX
Hong Kong, China
Huntley, IL
Leicester, England
Lille, France
Miami, FL
Milan, Italy
Möglingen, Germany
Montreal, Quebec
Osaka, Japan
Santa Fe Springs, CA

Other Representatives throughout
all parts of the world.



Union Special[®]
INDUSTRIAL SEWING EQUIPMENT