



*Union Special*  
INDUSTRIAL SEWING EQUIPMENT

**STYLES**

**ADJUSTING INSTRUCTIONS AND  
ILLUSTRATED PARTS LIST**

---

---

**39600CT  
39600CU**

**HI-STYLED HIGH SPEED FOURTHREAD  
INTERMITTENT DIFFERENTIAL FEED  
SAFETY STITCH MACHINES**

---

---

**CATALOG  
NO. 127P**

**SECOND  
EDITION**



Catalog No. 127 P  
(Supplement to Catalog No. 127 N)

INSTRUCTIONS

FOR

ADJUSTING AND OPERATING

LIST OF PARTS

CLASS 39600

Styles

39600 CT            39600 CU

Second Edition

Copyright 1968

By

Union Special Corporation  
Rights Reserved in All Countries

**UNION SPECIAL CORPORATION**

INDUSTRIAL SEWING MACHINES

**CHICAGO**

Printed in U.S.A.

October, 1975

## IDENTIFICATION OF MACHINES

Each Union Special machine is identified by a Style number on a name plate on the machine. Style numbers are classified as Standard and Special. Standard Style numbers have one or more letters suffixed but never contain the letter 'Z'. Example: 'Style 39600 CT'. Special Style numbers contain the letter 'Z'. When only minor changes are made in a standard machine, a 'Z' is suffixed to the Standard Style number. Example: 'Style 39600 CTZ'.

Styles of machines similar in construction are grouped under a class number which differs from the style number in that it contains no letters. Example: '39600'.

The distance between the rows of stitches or between the needles is represented by a gauge number measured in 1/64ths of an inch, going from left to right. The width of overedge is represented by a fraction. Collectively, the gauge number and the width of overedge represent the machine gauge. Example: '5-1/8". Thus, 5-1/8 gauge represents a distance of 5/64 inch between the left needle (401 stitch) and the right needle (503 or 504 stitch) and the 1/8 represents the width of overedge to the right of the right hand needle.

## APPLICATION OF CATALOG

This catalog is a supplement to Catalog No. 127 N, Second Edition and should be used in conjunction therewith. Only those parts used on Styles 39600 CT and CU, but not used on Style 39600 CP covered in Catalog 127 N are illustrated and listed at the back of this catalog. On the page opposite the illustration will be found a listing of the parts, with their part numbers, description and the number of pieces required. Numbers in the first column are reference numbers only, and merely indicate the position of that part in the illustration. Reference numbers should never be used in ordering parts. Always use the part number listed in the second column.

This catalog applies specifically to the Standard Styles of machines as listed herein. It can also be applied with discretion to some Special Styles of machines in this class. Reference to direction, such as right, left, front, back, etc., are given from the operator's position while seated at the machine. Operating direction of hand-wheel is away from operator.

## STYLES OF MACHINES

Two Curved Needles, Left Needle in Front, Two Looper, One Spreader, Four Thread Dual Stitch Machine, 401 Double Locked Stitch on Left Needle and 503 Two Thread Overedge Stitch on Right Rear Needle, Intermittent Differential Feed, Straight Upper Knife, Trimming Mechanism with Spring Pressed Lower Knife, Automatic Lubricating System.

39600 CT Medium to heavy duty machine, for seaming and intermittently gathering or shirring on woven materials such as dresses, aprons, lingerie, smocks, night-gowns and similar garments. Knee press controlled tandem intermittent differential feed. A foot treadle is used for lifting presser foot and pressure plate assembly. Independent swing-out pressure plate attachment for shirring. Gathering up to 3 to 1 depending on stitch length. Seam specification (401-503) 515-SSa-2. Standard gauge and seam widths are 5-1/8 and 12-3/16. Stitch range 8 to 16 per inch; cam adjusted main and differential feeds. Needle Type 158 GJS for 401 stitch and needle Type 154 GAS for 503 stitch. Maximum recommended speed up to 6000 R. P. M., depending on operation and ratio of shirring required.

39600 CU Same as Style 39600 CT except with a gathering ratio up to 5 to 1 depending on stitch length. Maximum recommended speed up to 5500 R. P. M., depending on operation and ratio of shirring required.

## OILING

CAUTION! Oil was drained from machine when shipped, so reservoir must be filled before beginning to operate. Oil capacity of Class 39600 is six ounces. A straight mineral oil of a Saybolt viscosity of 90 to 125 seconds at 100° Fahrenheit should be used.

Machine is filled with oil at spring cap in top cover. Oil level is checked at the sight gauge on front of the machine. Red bulb on oil level indicator should show between gauge lines.

Machine is automatically lubricated. No oiling is necessary, other than keeping main reservoir filled. Check oil daily before the morning start; add oil as required.

The oil drain plug screw is located at the back of machine near bottom edge of base. It is a magnetic screw designed to accumulate possible foreign materials which may have entered the crank case. It should be removed and cleaned periodically.

## NEEDLES

Each Union Special needle has both a type and size number. The type number denotes the kind of shank, point, length, groove, finish and other details. The size number, stamped on the needle shank, denotes largest diameter of blade, measured in thousandths of an inch, midway between shank and eye. Collectively, type and size number represent the complete symbol which is given on the label of all needles packaged and sold by Union Special.

Two needles having different lengths are used in these machines. The shorter needle for the overedge stitch, located at the right, is Type 154 GAS. It is a round shank, round point, curved blade, standard length, single groove, struck groove, spotted, chromium plated needle and is available in sizes 055/022, 065/025, 070/027, 075/029, 080/032, 090/036, 040, 044, 049, 054, 060.

The longer needle for the 401 stitch, located at the left, is Type 158 GJS. It is a round shank, round point, curved blade, flat tapered blade, Class "B" length, double groove, struck groove, long spot, government point, chromium plated needle and is available in sizes 027, 029, 080/032, 090/036, 100/040, 110/044, 125/049.

To have needle orders promptly and accurately filled, an empty package, a sample needle, or the type and size number should be forwarded. Use description on label. A complete order would read: "1000 Needles, Type 154 GAS, Size 090/036".

Selection of proper needle size is determined by size of thread used. Thread should pass freely through needle eye in order to produce a good stitch formation.

Success in the operation of Union Special machines can be secured only by use of needles packaged under our brand name, *Union Special*, which is backed by a reputation for producing highest quality needles in materials and workmanship for more than three-quarters of a century.

## CHANGING NEEDLES

Release pressure on presser foot by turning the presser foot release bushing (A, Fig. 1) and swinging presser arm (B) out of position. Turn handwheel in operating direction (away from operator) until needle holding screws are just exposed from behind presser spring plunger and accessible to screw driver. Loosen screws and withdraw needles. When replacing needles observe the position of the flat which is at the left of the shank and be sure the needles are inserted the full depth to the combination eyelet and stop plate.

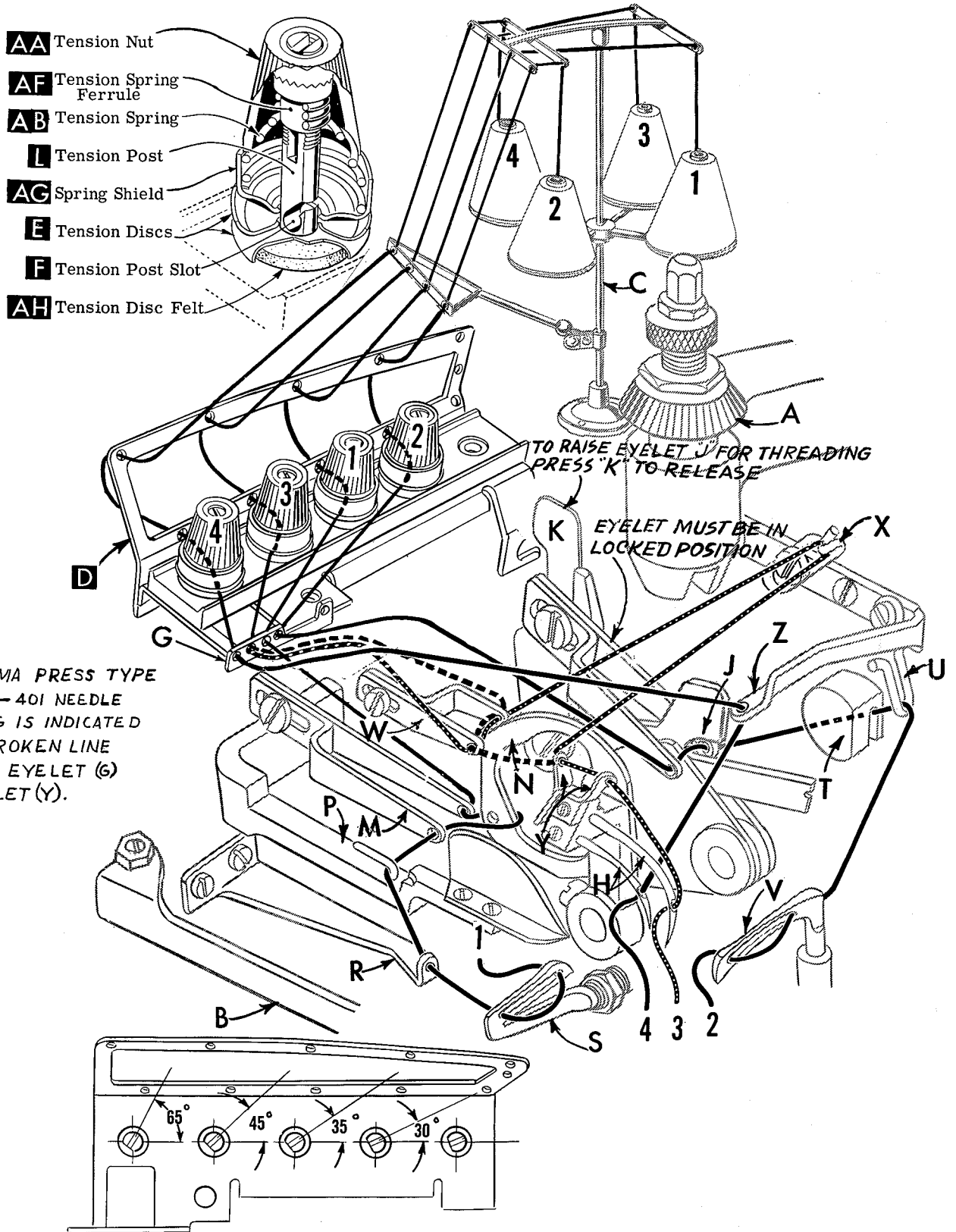

Fig. 1

## THREADING

Only parts involved in threading are shown in threading diagram (Fig. 1). Parts are placed in their relative positions for clarity.

Thread from thread stand (C) is threaded through the upper holes of tension thread guide (D) from front to back and then through the lower holes from back to front. The threads then continue between the tension discs (E), through tension post slot (F) in tension post (L) and on through front thread guide (G).

It will simplify the threading of machine to follow the recommended sequence as designated by the numbers assigned to each thread, starting with thread No. 1, then No. 2, etc. The various eyelets and guides on the machine for each thread have been color coded to further aid the threading process.

Thus the sequence for Styles 39600 CT and CU is as follows: Thread No. 1, lower looper thread, yellow color code; thread No. 2, 401 looper thread, blue color code; thread No. 3, 401 needle thread, red color code; thread No. 4, overedge needle thread, green color code.

Before beginning to thread, swing cloth plate open, turn handwheel in operating direction until the needles (H) are at their highest position, release pressure on presser foot by turning presser foot release bushing (A), and swing presser arm (B) out of position.

RAISE 401 LOOPER THREAD TAKE-UP EYELET (J) BY RELEASING EYELET LATCH (K) AND RAISING EYELET

### THREADING LOWER LOOPER (Thread No. 1-Yellow Color Code)

Double end of lower looper thread (#1) and lead it through both eyes of lower looper thread eyelet (M) from right to left. NOTE: Thread must pass through the inside of needle thread cam pull-off (N). Lead thread back under hook of fabric guard bracket (P) and through eye of frame looper thread guide (R). Turn handwheel in operating direction until heel of lower looper (S) is all the way to the left; then thread through left eye, entering from the rear, and then through the right eye entering from the front. Left eye of lower looper can be threaded easily if tweezers are held with the left hand.

### THREADING 401 LOOPER (Thread No. 2-Blue Color Code)

Double end of 401 looper thread (#2) and lead it through both eyes of looper thread take-up eyelet (J) from left to right, when the eyelet is in raised position. Return eyelet to its lower position by pressing it down. When eyelet is in correct position, latch will snap into place. Pass thread under knife arm, into groove of the upper knife support block (T), and over hook (U). Bring needle arm to bottom of its stroke. Insert double end of thread in right eye of 401 looper (V) and push through an inch or so of thread. Holding tweezers in left hand insert doubled end of thread into left eye, using about 3/16 inch projection of thread from point of tweezers. DO NOT THREAD LOOPER WITH NEEDLE LOOP AROUND LOOPER. REMOVE LOOP, OTHERWISE MACHINE WILL NOT SEW.

### THREADING 401 NEEDLE (Thread No. 3-Red Color Code)

Lower needle arm to bottom of its stroke, by turning handwheel in operating direction. Threading from left to right, pass the 401 needle thread (#3) through both eyes of needle thread pull-off eyelet (W), passing over the outside of the needle

## THREADING 401 NEEDLE (Thread No. 3 - Red Color Code) (Continued)

thread cam pull-off (N). Then thread through eyelet (X) from front to back, through the top eye of needle driving arm thread eyelet (Y), through lower eye and finally through the eye of the left needle (H). Raise needle by rotating handwheel in operating direction and thread needle from front to back.

NOTE: When sewing perma-press type material, thread should pass through both eyes of needle thread pull-off eyelet (W) from right to left, then through both eyes of eyelet (Y) and finally through the needle.

## THREADING OVEREDGE NEEDLE (Thread No. 4 - Green Color Code)

Turn handwheel in operating direction until the needle is at its highest position. Pass overedge needle thread (#4) under overhanging arm of top cover and down through hole in top cover needle thread eyelet (Z). Thread needle (H) from front to back.

## THREAD TENSION

The amount of tension on the needle and looper threads is regulated by the knurled tension nuts (AA, Fig. 1). Tension on the threads should be only enough to secure proper stitch formation. Using a postal scale, the measurements are taken with the needles at the top of their stroke and pulled in the direction as indicated. As a start the tensions may be as follows:

401 needle thread; 1 oz. straight out of lower eye of needle arm eyelet (Y).

Overedge needle thread; 1 to 1 1/2 oz. straight out of thread guide (G).

401 looper thread; 1 1/2 to 2 oz. straight out of looper thread eyelet (U).

Lower looper thread; 4 to 4 1/2 oz. straight out of frame looper thread guide (R).

## FEED ECCENTRICS

Feed eccentrics used in Styles 39600 CT and CU machines have been selected to produce approximately 12 stitches per inch. It will be noted that the part number of main feed eccentric is No. 39540 B-12 while that of the differential feed eccentric is No. 39540 B-4 for Style 39600 CT and No. 39540 C for Style 39600 CU. Minor numbers of the part symbol indicate approximately the number of stitches obtainable when using that eccentric. Unless otherwise specified, machine will be shipped with above combination of eccentrics.

Generally speaking, the main (right hand) feed eccentric determines the number of stitches produced; the differential (left hand) feed eccentric is selected so as to give the proper differential or gathering action.

Following stitch number feed eccentrics are available under No. 39540 B-4, -5, -6, -7, -8, -9, -10, -11, -12, -13, -14, -15, -16, -18, -20, -22, -24, -26, -28, -30, -32, -34, -36, -40. Only two eccentrics are supplied with each machine. Additional eccentrics may be ordered separately. To order an eccentric, use No. 39540 B with a minor number suffixed to indicate number of stitches desired. Example: "39540 B-12".

NOTE: When reassembling eccentrics, allow .003 inch (.076 mm) clearance between the thrust finger and the differential feed drive connecting rod in a 360° turn.



## INSTRUCTIONS FOR MECHANICS

The adjusting instructions for Styles 39600 CT and CU are the same as for Style 39600 CP, covered in Catalog No. 127 N (Second Edition), with the following exceptions and additions.

### 'SETTING THE FEED DOGS'

On Style 39600 CT, the front extension of the main feed dog must rest on the rear pad of the differential feed dog which acts as a support.

### 'SETTING THE LOWER KNIFE'

On Style 39600 CT, the beveled edge of the lower knife clamp screw nut must be parallel with the throat plate to assure a safe margin of clearance for travel of the differential feed dog.

## ADDITIONAL ADJUSTING INSTRUCTIONS FOR STYLES 39600 CT and CU

### SETTING THE DIFFERENTIAL RATIO

Differential feed action is obtainable thru the use of the two micrometer adjusting screws.

The position of the differential control lever (A, Fig. 27) is governed by an upper stop (B) and a lower stop (C). The amount of lever movement between these two stops determines the feed action.

The differential feed action is also controlled by the movement of the differential control lever between an upper and a lower stop, but both stops are moved by an adjusting thumbscrew rod.

To set the amount of differential or plain feed, turn the plain feed control adjusting rod, it is the larger knurled head screw located on the bed in back of the tension post assembly. Turning this rod clockwise decreases the amount of differential and turning it counter-clockwise increases the amount of differential.

The amount of intermittent differential feed is set by turning the differential feed control adjusting rod, it is the smaller knurled head screw located just above the plain feed control adjusting rod. Turning this screw clockwise lowers the stop and thus increases the amount of differential, when the differential feed control lever is actuated. Turning this screw counterclockwise acts the reverse.

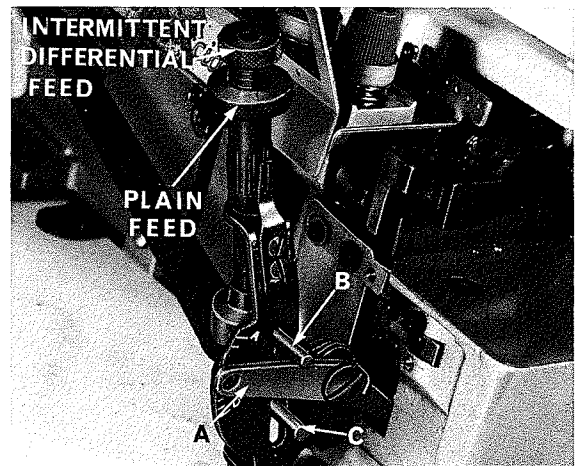

Fig. 27

### SETTING THE PRESSER FOOT HOLD DOWN PLATE

These machines are equipped with a presser foot hold down plate. The purpose of this plate is to hold down the rear of the presser foot and when set correctly it will help produce a more flat pucker free seam. Set the machine with the feed dogs below the throat plate and insert a .005 inch (.127 mm) shim under the front portion of presser foot. Loosen screws which hold the hold down plate in position and move the plate down until it rests firmly against the presser foot. Tighten the two screws and remove the shim.

## SETTING THE PRESSER FOOT HOLD DOWN PLATE (Continued)

NOTE: Always be sure the feed dogs are below surface of throat plate when making this setting.

### SETTING THE PRESSURE PLATE ASSEMBLY

These machines are equipped with an auxiliary pressure plate assembly (Fig. 28) which operates in conjunction with the presser foot. Check the operation of this assembly as follows:

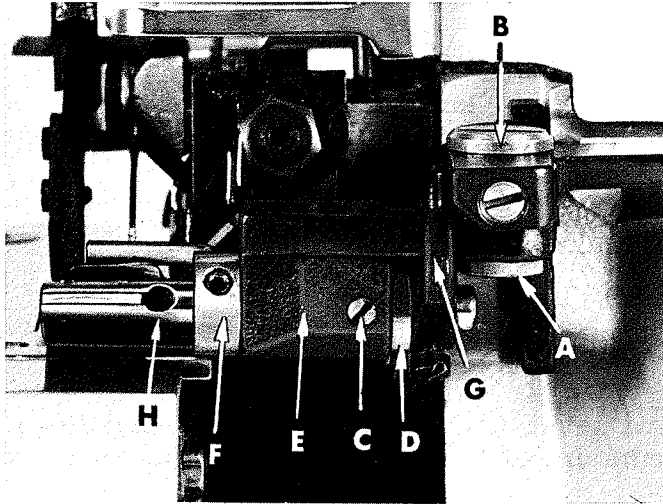

Fig. 28

1. Swing the pressure plate assembly in and out of its operating position and check to assure that it hinges freely on its pivot. If not, loosen lock nut (A, Fig. 28) and adjust shoulder screw (B) for smooth operation.
2. Loosen set screw (C, Fig. 28) and turn the shaft collar (D) counter-clockwise (viewed from the left side of machine) using the spanner wrench provided, so there is some tension on the tension spring located in the shaft bracket (E) and the pressure plate (A, Fig. 29) is forced down slightly.

3. Adjust tension spring, located in the mounting bracket (B, Fig. 29) with inner screw, after removing outer screw (C). Spring should be tight enough to allow assembly to snap into place and still allow the mechanism to swing out easily. Lock inner screw with outer screw (C).

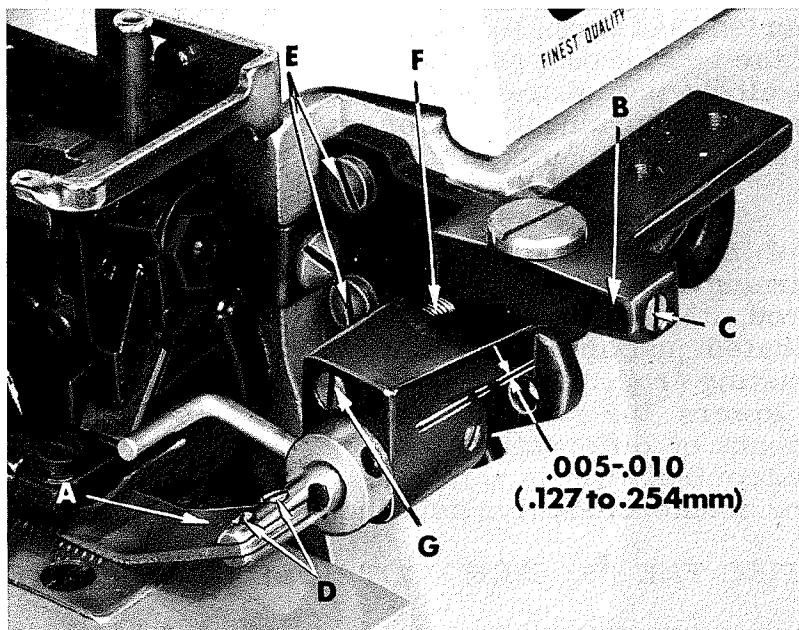
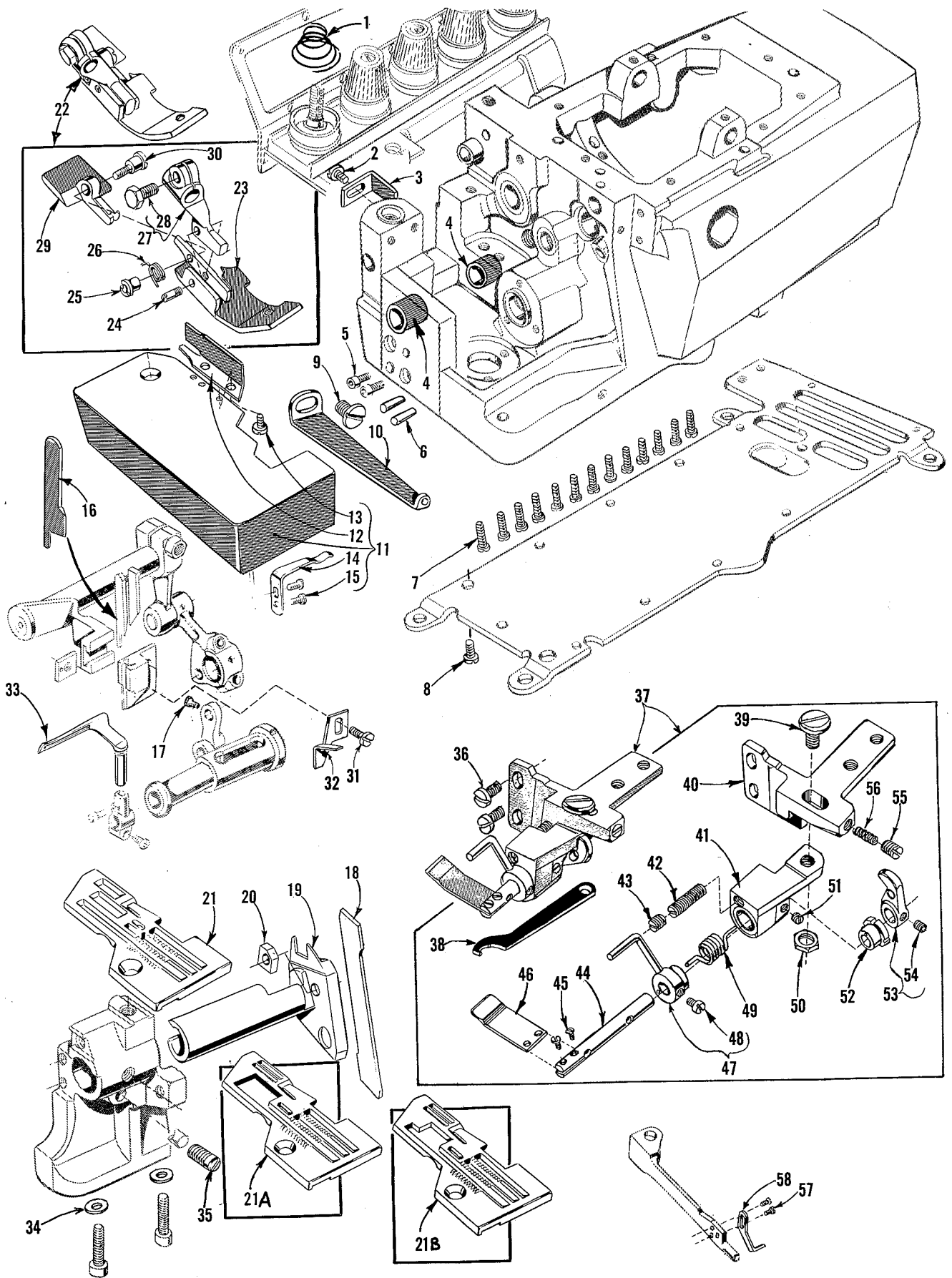

Fig. 29

4. With the feed dogs down, look horizontally between the pressure plate and the throat plate from the front of the machine to assure that the pressure plate lies flat on the throat plate. If not, loosen the two screws (D, Fig. 29) which hold the pressure plate (A) and adjust flat to the throat plate.

## SETTING THE PRESSURE PLATE ASSEMBLY (Continued)

5. Raise or lower the mounting bracket (B, Fig. 29) by loosening screws (E) so that, from the side, the pressure plate is parallel and flat on the throat plate. Retighten screws (E).
6. Adjust screw (F, Fig. 29) so that the front edge of the pressure plate is square to the feed dog teeth. Lock with screw (G).
7. Center pressure plate over the feed dogs by loosening the screws in the actuating collar (F, Fig. 28) and the operating lever (G), and then adjust shaft (H) laterally as required.
8. When retightening operating lever screw make sure that the feed dogs and the pressure plate are down, then tighten operating lever screw leaving approximately .005 to .010 inch (.127 to .254 mm) clearance (See Fig. 29) between operating lever and shaft bracket (E, Fig. 28).
9. With feed dogs up, check from the left side to see if the clearance between the pressure plate and the presser foot is wide enough to allow the largest seam to pass. If not, adjustment can be made by loosening screws (E, Fig. 29) and moving the mounting bracket (B) straight toward the operator. Retighten screws (E). Recheck Step 4.
10. The actuating collar (F, Fig. 28) should now be set so that, throughout one revolution of the machine, the minimum distance between the lifter rod and the presser foot is 1/32 inch (.79 mm). The lifter rod should be set to clear the tip of the presser foot if it is important that the shirring mechanism can be swung away without moving the presser foot away first.
11. Loosen set screw (C, Fig. 28) for final adjustment of pressure plate tension spring. Turn shaft collar (D) with spanner wrench until desired tension is acquired to obtain a uniform shirr. Retighten set screw (C).



The parts illustrated on pages 12 and 14, and described on this page and page 15, represent the parts that are used on Styles 39600 CT and CU, but not used on Style 39600 CP.

Those parts shown in phantom views and bearing no reference numbers are common to Styles 39600 CP, CT and CU.

Use Catalog No. 127 N, Second Edition (Style 39600 CP) for all parts not illustrated or described in this catalog.

Reference numbers that are inside a bracket or box on the picture plates and have indented descriptions, indicate they are component parts of a complete part or assembly.

Ref. No.	Part No.	Description	Amt. Req.
1	39592 AR-2	Tension Spring, for 401 stitch looper -----	1
	39592 AR-5	Tension Spring, for needles and 503 stitch looper -----	3
2	22569 C	Screw, for feed bar guide -----	1
3	39535 H	Feed Bar Guide -----	1
4	43243 N	Differential Feed Rocker Shaft Bushing -----	2
5	22653 B-12	Socket Head Cap Screw -----	2
6	667 B-12	Dowel Pin -----	2
7	22569	Screw, for bottom cover -----	13
8	22569 C	Screw, for bottom cover -----	1
9	22569 D	Screw, for looper thread eyelet -----	1
10	39568 R	Looper Thread Eyelet -----	1
11	39501 DE	Cloth Plate Assembly, for Style 39600 CU -----	1
-	39501 DH	Cloth Plate Assembly, for Style 39600 CT -----	1
12	39578 F	Fabric Guard -----	1
13	138	Screw, for fabric guard -----	2
14	39532 A	Latch Spring -----	1
15	90	Screw, for latch spring -----	2
16	39270 J	Upper Knife -----	1
17	22781	Screw, for looper avoid link pin -----	1
18	39549 J	Lower Knife -----	1
19	39650 C	Lower Knife Holder -----	1
20	39650 B	Lower Knife Clamp Screw Nut -----	1
21	39624 D-5-1/8	Throat Plate, marked "BR-5-1/8", for No. 5-1/8 gauge, Style 39600 CU -----	1
-	39624 K-5-1/8	Throat Plate, marked "CF-5-1/8", for No. 5-1/8 gauge, Style 39600 CT -----	1
21A	39624 D-12-3/16	Throat Plate, marked "BR-12-3/16", for No. 12-3/16 gauge, Style 39600 CU --	1
21B	39624 K-12-3/16	Throat Plate, marked "CF-12-3/16", for No. 12-3/16 gauge, Style 39600 CT --	1
22	39620 D-5-1/8	Presser Foot, bottom marked "AS-5-1/8", for No. 5-1/8 gauge, all Styles ----	1
-	39620 D-12-3/16	Presser Foot, bottom marked "AS-12-3/16", for No. 12-3/16 gauge, all Styles	1
23	39630 P-5-1/8	Presser Foot Bottom, marked "AS-5-1/8", for No. 39620 D-5-1/8 -----	1
	39630 P-12-3/16	Presser Foot Bottom, marked "AS-12-3/16", for No. 39620 D-12-3/16 ---	1
24	22799 U	Hinge Screw -----	1
25	39630 L	Lock Nut -----	1
26	39630 N	Spring -----	1
27	39630 G	Presser Foot Shank, marked "D", for No. 39620 D-5-1/8 -----	1
-	39630 J	Presser Foot Shank, marked "E", for No. 39620 D-12-3/16 -----	1
28	22781	Screw -----	1
29	39630 H	Needle Hole Section, marked "AT", for No. 39620 D-5-1/8 -----	1
-	39630 K	Needle Hole Section, marked "AR", for No. 39620 D-12-3/16 -----	1
30	39630 M	Hinge Screw, for needle hole section -----	1
31	187 A	Screw, for chip deflector -----	1
32	39678 P	Chip Deflector -----	1
33	39608 A	Looper, marked "CN", for 401 stitch -----	1
34	39580 F	Washer, for throat plate support bracket screw -----	2
35	88 F	Screw, for 401 stitch rear needle guard -----	1
36	22569 C	Screw, for pressure plate assembly -----	2
37	29480 GY	Pressure Plate Assembly -----	1
38	21388 Y	Spanner Wrench -----	1
39	35751 D	Shoulder Screw for mounting bracket -----	1
40	39531 J	Mounting Bracket -----	1
41	39531 K	Shaft Bracket -----	1
42	22597 E	Set Screw, for shaft bracket -----	1
43	95	Lock Screw, for shaft bracket -----	1
44	39531 P	Pressure Plate Shaft -----	1
45	22738	Screw, for pressure plate -----	2
46	39631 B	Pressure Plate -----	1
47	39531 W	Actuating Collar -----	1
48	22894 Y	Set Screw, for actuating collar -----	1
49	39531 R	Pressure Plate Tension Spring -----	1
50	15037 A	Lock Nut, for shoulder screw -----	1
51	22743	Set Screw, for pressure plate shaft -----	1
52	39531 M	Pressure Plate Shaft Collar -----	1
53	39531 H	Operating Lever -----	1
54	77 A	Set Screw, for operating lever -----	1
55	22580 A	Screw, for tension spring -----	1
56	39531 L	Tension Spring, for shoulder screw -----	1
57	605	Screw, for presser foot hold down plate -----	2
58	39656 D	Presser Foot Hold Down Plate -----	1

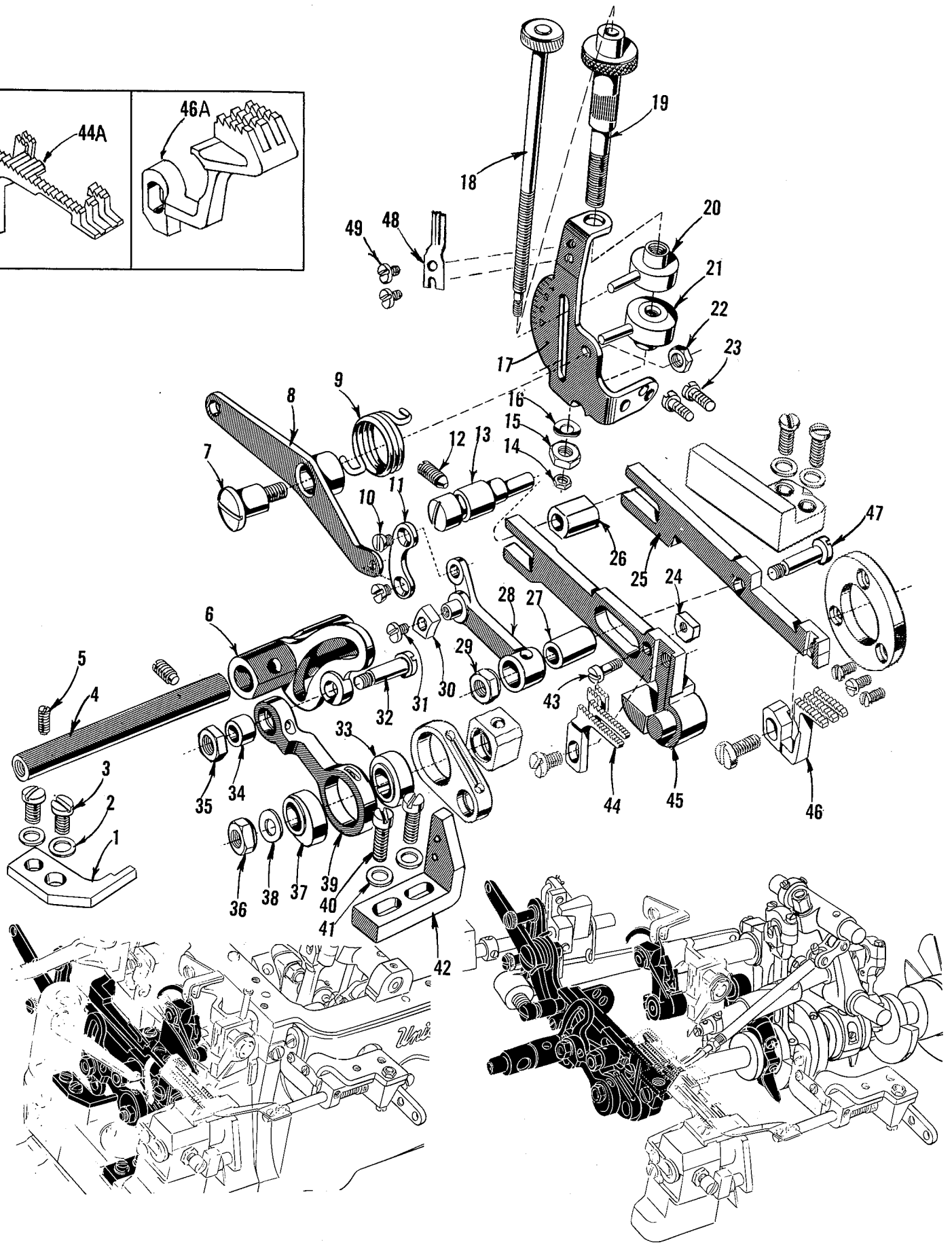
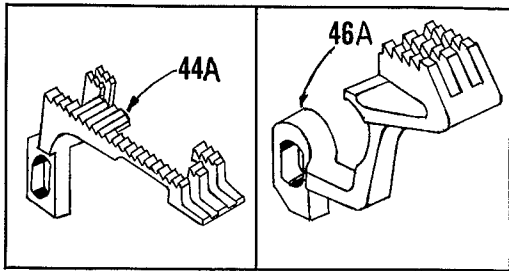

DIFFERENTIAL FEED DRIVING MECHANISM

Ref. No.	Part No.	Description	Amt. Req.
1	39536 H	Thrust Finger -----	1
2	53634 C	Washer, for thrust finger -----	2
3	22569 C	Screw, for thrust finger -----	2
4	39536 M	Differential Feed Rocker Shaft -----	1
5	22565 B	Screw, for differential feed rocker shaft -----	2
6	39536 L	Differential Feed Rocker -----	1
7	22557 E	Screw, for differential feed control lever -----	1
8	39536 U	Differential Feed Control Lever -----	1
9	39536 V	Differential Feed Control Spring -----	1
10	39536 Y	Screw, for control lever connecting link -----	2
11	39536 W	Control Lever Connecting Link -----	1
12	22565 F	Screw, for feed adjusting pin -----	1
13	39535 E	Feed Adjusting Pin -----	1
14	12934 A	Lock Nut, for differential feed control adjusting rod-----	1
15	39536 AH	Friction Nut, for differential feed control adjusting rod-----	1
16	39198 D	Spring Washer -----	1
17	39636	Differential Feed Control Mounting Bracket -----	1
18	39636 C	Differential Feed Control Adjusting Rod -----	1
19	39636 A	Plain Feed Control Adjusting Rod -----	1
20	39636 B	Plain Feed Control Adjustable Stop -----	1
21	39636 D	Differential Feed Control Adjustable Stop -----	1
22	18	Nut, for differential feed control lever screw-----	1
23	22569 C	Screw, for differential feed control mounting bracket-----	2
24	39536 X	Differential Feed Bar Guide Block -----	1
25	39534 B	Differential Feed Bar -----	1
26	39535 J	Feed Bar Guide Block-----	1
27	39536 R	Feed Bar Drive Connecting Bushing -----	1
28	39536 P	Differential Feed Drive Link-----	1
29	39536 E	Nut, for differential feed bar driving stud -----	1
30	39536 N-249	Differential Feed Regulating Sliding Block-----	1
31	28	Screw, for differential feed regulating sliding block -----	1
32	39536 J	Differential Feed Drive Connecting Rod Stud-----	1
33	39540 B-12	Main Feed Driving Eccentric -----	1
34	39536 K	Feed Rocker Drive Connecting Bushing -----	1
35	39536 E	Nut, for differential feed drive connecting rod stud-----	1
36	258	Nut, for crankshaft -----	1
37	39540 C	Differential Feed Driving Eccentric, for Style 39600 CU -----	1
-	39540 B-4	Differential Feed Driving Eccentric, for Style 39600 CT -----	1
38	40-46	Washer, for crankshaft -----	1
39	39536 G	Differential Feed Drive Connecting Rod, for Style 39600 CU-----	1
-	39536 F	Differential Feed Drive Connecting Rod, for Style 39600 CT-----	1
40	22569	Screw, for feed bar guide, left-----	2
41	53634 C	Washer, for feed bar guide, left -----	2
42	39635 A	Feed Bar Guide, left -----	1
43	22726 L	Screw, for differential feed bar guide block -----	1
44	39605 A-5 1/8	Main Feed Dog, 16 teeth per inch, marked "BC", for No. 5 1/8 gauge, Style 39600 CU-----	1
-	39605 B-12 3/16	Main Feed Dog, 14 teeth per inch, marked "BH", for No. 12 3/16 gauge, Style 39600 CU-----	1
44A	39605 K-5 1/8	Main Feed Dog, 16 teeth per inch, marked "EF", for No. 5 1/8 gauge, Style 39600 CT-----	1
-	39605 K-12 3/16	Main Feed Dog, 16 teeth per inch, marked "EH", for No. 12 3/16 gauge, Style 39600 CT-----	1
45	39534 A	Main Feed Bar -----	1
46	39626 J	Differential Feed Dog, 16 teeth per inch, marked "CP", for Style 39600 CU, all gauges -----	1
46A	39626 K	Differential Feed Dog, 16 teeth per inch, marked "EG", for Style 39600 CT, all gauges -----	1
47	39536 S	Differential Feed Bar Driving Stud -----	1
48	39636 E	Ratchet Stop Spring -----	1
49	88 A	Screw, for ratchet stop spring -----	2

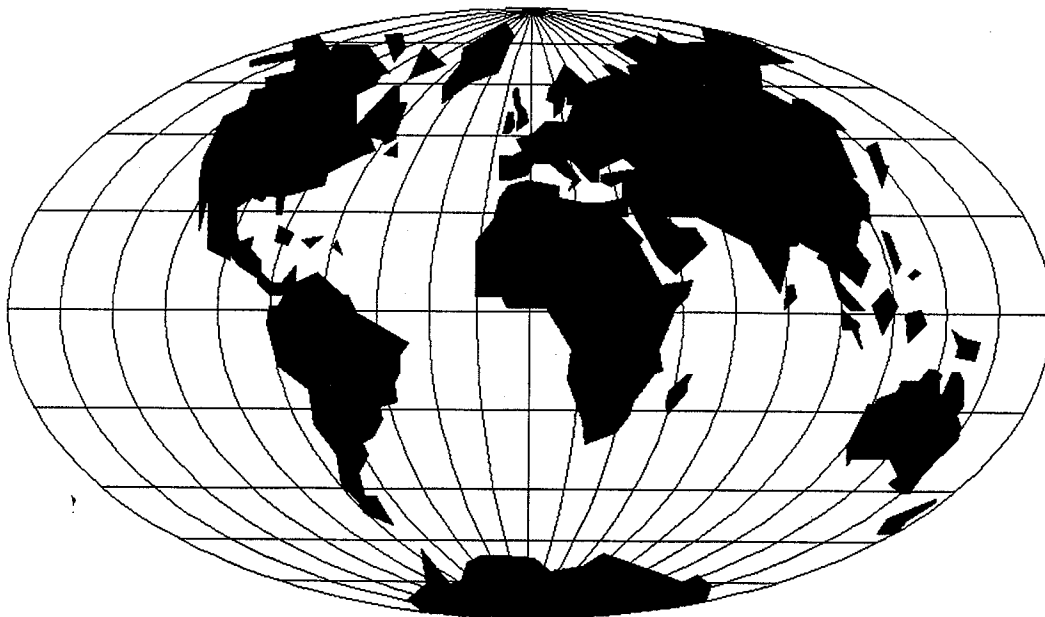

## WORLDWIDE SALES AND SERVICE

Union Special Corporation maintains sales and service facilities throughout the world. These offices will aid you in the selection of the right sewing equipment for your particular operation. Union Special Corporation representatives and service technicians are factory trained and are able to serve your needs promptly and efficiently. Whatever your location, there is a qualified representative to serve you.

---

**Corporate Office:** One Union Special Plaza  
Huntley, IL 60142  
Phone: 847•669•5101  
Fax: 847•669•1096

**European Distribution Center:** Union Special GmbH  
Raiffeisenstrasse 3  
D-71696 Möglingen, Germany  
Tel: 49•07141•247•0  
Fax: 49•7141•247•100

Brussels, Belgium  
Charlotte, N.C.  
El Paso, TX  
Hong Kong, China  
Huntley, IL  
Leicester, England  
Lille, France  
Miami, FL  
Milan, Italy  
Möglingen, Germany  
Montreal, Quebec  
Osaka, Japan  
Santa Fe Springs, CA

Other Representatives throughout  
all parts of the world.



*Union Special*  
INDUSTRIAL SEWING EQUIPMENT