

FINEST QUALITY

Union Special[®]
L E W I S • C O L U M B I A

**INDUSTRIAL
SEWING
MACHINES**

**STYLE
39500FW**

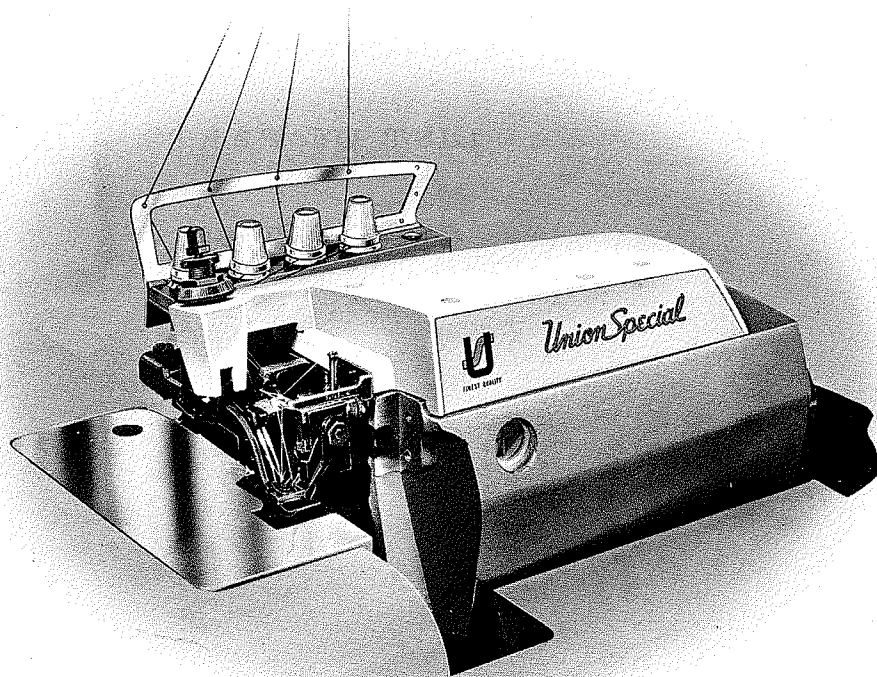

CLASS 39500

**HI-STYLED HIGH SPEED
TWO NEEDLE FOUR THREAD
DIFFERENTIAL FEED
OVERSEAMING MACHINE**

**CATALOG
No.
103FW**

Union Special **MACHINE COMPANY**
CHICAGO

FIRST EDITION
© 1967

PRINTED 1996 IN USA

INFORMATION SUBJECT TO CHANGE WITHOUT NOTICE

© UNION SPECIAL CORPORATION ALL RIGHTS RESERVED IN ALL COUNTRIES.

IDENTIFICATION OF MACHINES

Each Union Special machine is identified by a Style number on a name plate on the machine. Style numbers are classified as standard and special. Standard Style numbers have one or more letters suffixed, but never contain the letter "Z". Example: "Style 39500 FW". Special Style numbers contain the letter "Z". When only minor changes are made in a standard machine, a "Z" is suffixed to the standard Style number. Example: "Style 39500 FWZ".

Styles of machines similar in construction are grouped under a Class number which differs from the Style number in that it contains no letters. Example: "Class 39500".

APPLICATION OF CATALOG

This catalog is a supplement to Catalog No. 103 FA and should be used in conjunction therewith. Only those parts used on Style 39500 FW, but not on Style 39500 FP are illustrated and listed at the back of this catalog. On the page opposite the illustration will be found a listing of the parts with their part numbers, description and the number of pieces required. Numbers in the first column are reference numbers only, and merely indicate the position of that part in the illustration. Reference numbers should never be used in ordering parts. Always use the part number listed in the second column.

This catalog applies specifically to the standard Styles of machines as listed herein. It can also be applied with discretion to some Special Styles of machines in Class 39500. References to directions, such as right, left, front, back, etc., are given from the operator's position while seated at the machine. Operating direction of handwheel is away from operator.

STYLE OF MACHINE

Hi-Styled High Speed, Two Curved Blade Needles, Two Loopers, Four Thread Overseaming Machine. Differential Feed, Trimming Mechanism with Spring Pressed Lower Knife, Automatic Lubricating System.

39500 FW Medium to heavy duty machine for seaming medium to heavy weight knitted and woven fabrics with a modified safety stitch. For operations on pajamas, bathing suits, house dresses, children's wear, ladies' undergarments and similar garments of light to medium heavy weight woven and knitted garments of wool, cotton, silk and synthetics. Seam specification 512-SSa-1. Standard width of seam from left needle 17/64 inch. Stitch range 6-20 per inch. Cam adjusted main and differential feeds. Maximum recommended speed 6500 R. P. M.

OILING

CAUTION! Oil was drained from machine when shipped, so reservoir must be filled before beginning to operate. Oil capacity of Class 39500 is six ounces. A straight mineral oil of a Saybolt viscosity of 200 to 250 seconds at 100° Fahrenheit should be used.

Machine is filled with oil at spring cap in top cover. Oil level is checked at sight gauge on front of machine. Red bulb on oil level indicator should show between gauge lines when machine is stationary.

OILING (Continued)

Machine is automatically lubricated. No oiling is necessary, other than keeping main reservoir filled. Check oil daily before the morning start; add oil as required.

The oil drain plug screw is located at back of machine near bottom edge of base. It is a magnetic screw designed to accumulate possible foreign materials which may have entered the crank case. It should be removed and cleaned periodically.

NEEDLES

Each Union Special Needle has both type and size number. The type number denotes the kind of shank, point, length, groove, finish and other details. The size number, stamped on the needle shank, denotes largest diameter of blade, measured in thousandths of an inch, midway between shank and eye. Collectively, type and size number represent the complete symbol which is given on the label of all needles packaged and sold by Union Special.

Class 39500 machines use a curved blade needle. The standard recommended needle for the machine covered in this catalog is Type 154 GAS. Below is the description and sizes available of the recommended needle.

<u>Type No.</u>	<u>Description and Sizes</u>
154 GAS	Round shank, round point, curved blade, standard length, single groove, struck groove, spotted, chromium plated and is available in sizes 022, 025, 027, 029, 032, 036, 040, 044, 049, 054.

To have needle orders promptly and accurately filled, an empty package, a sample needle, or the type and size number should be forwarded. Use description on label. A complete order would read: "1000 Needles, Type 154 GAS, Size 036".

Selection of proper needle size is determined by size of thread used. Thread should pass freely through needle eye in order to produce a good stitch formation.

Success in the operation of Union Special machines can be secured only by use of needles packaged under our brand name, *Union Special*, which is backed by a reputation for producing highest quality needles in materials and workmanship for more than three-quarters of a century.

CHANGING NEEDLES

Release pressure on presser foot by turning presser foot release bushing (AG, Fig. 1) and swing presser arm (U) out of position. Turn handwheel in operating direction until needle is at its lowest point of travel. Using hexagonal socket wrench No. 21388 AU, furnished with machine, loosen needle clamp nut about 1/4 turn. Again turn handwheel until needle is at high position; withdraw needle.

To replace needle, leave needle holder at high position and, with the flat to the left, insert needle in holder until it rests against stop pin. Keeping needle in this position, turn handwheel until holder is again at its low point of travel; then tighten nut. Return presser arm (U) to position; re-lock presser foot release bushing (AG).

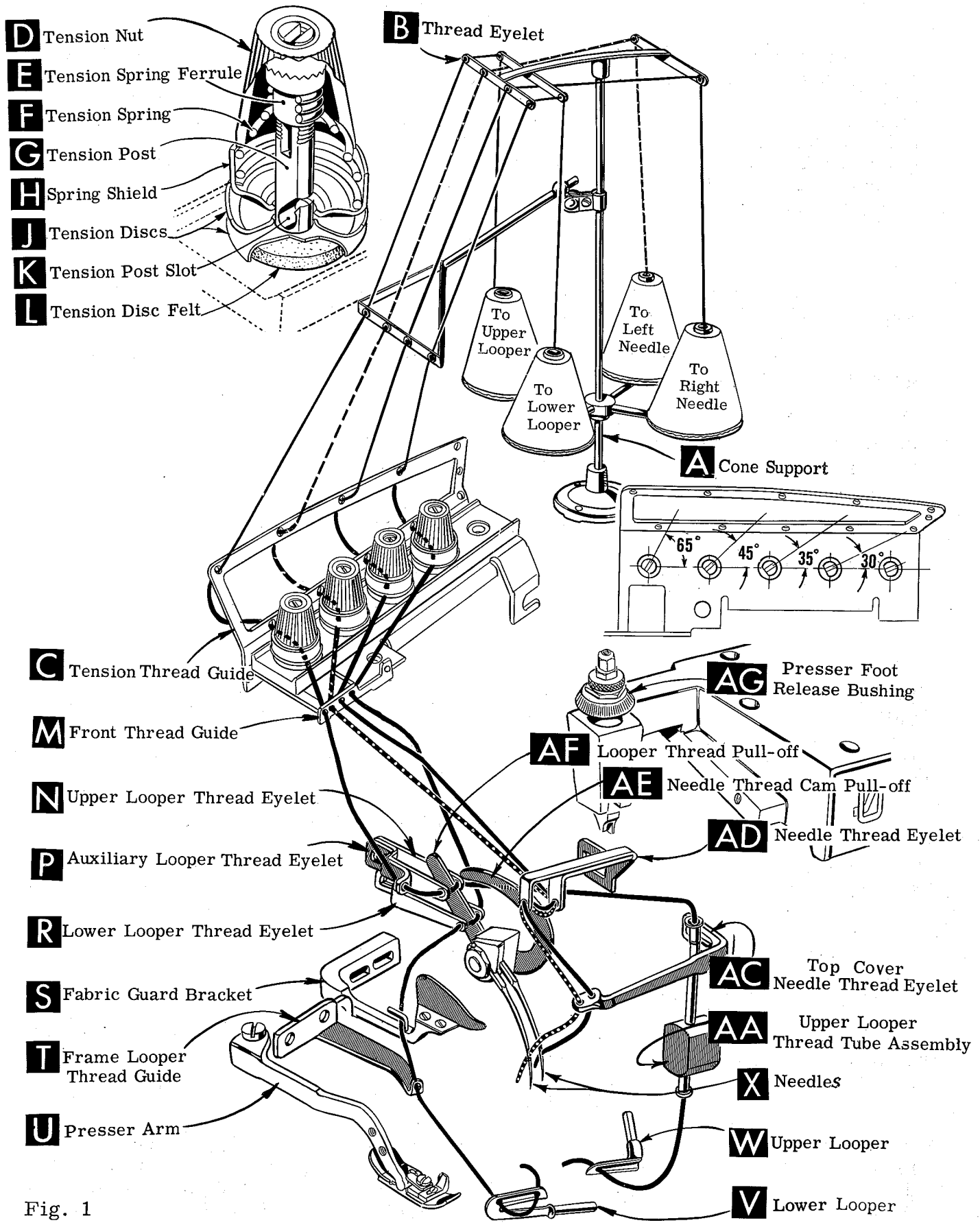

Fig. 1

THREAD STAND

After thread comes from cones on cone support (A, Fig. 1), the needle threads are threaded through the back bar of the thread eyelet (B), under the middle bar and through the center holes of the front bar. The looper threads come from the cones, through holes of the middle bar from back to front and then through the two outside holes of the front bar. Next it is threaded through the upper holes of tension thread guide (C) front to back and then through the lower holes from back to front. The threads continue between the tension discs (J), through tension post slot (K) in tension post (G) and on through front thread guide (M).

THREADING

Only parts involved in threading are shown in the threading diagram (Fig. 1). Parts are placed in their relative positions for clarity.

It will simplify the threading of these machines to follow the recommended sequence of threading lower looper first, upper looper second, and the needles third.

Before beginning to thread, swing cloth plate open, turn handwheel in operating direction until needles (X) are in high position, release pressure on presser foot by turning presser foot release bushing (AG), and swing presser arm (U) out of position.

Be sure the threads, as they come from the tension thread guide (C), are between the tension discs (J) and in tension post slot (K) in tension post (G). The tension posts should be positioned so the tension post slot will be at the approximate angle for the different threads as indicated in Fig. 1.

TO THREAD LOWER LOOPER

Double end of thread and lead it through both eyes of lower looper thread eyelet (R, Fig. 1) from right to left. NOTE: Thread must pass in front of looper thread pull-off (AF). Lead thread behind fabric guard (S) and through hole of frame looper thread guide (T). Turn handwheel in operating direction until heel of lower looper (V) is all the way to the left; then thread through both eyes from left to right. Left eye of lower looper can be threaded easily if tweezers are in left hand.

TO THREAD UPPER LOOPER

Turn handwheel until point of upper looper (W) is all the way left. Lead thread through auxiliary looper thread eyelet (P) from back to front, then through both eyes of upper looper thread eyelet (N) from left to right. NOTE: Thread must pass in front of looper thread pull-off (AF). After pulling up upper looper thread tube assembly (AA), lead thread under neck of top cover casting and down through thread tube assembly (AA). Pull thread out bottom of tube; push tube down, then insert thread through upper looper eye from front to back.

CAUTION! Be sure upper looper thread is under lower looper thread when passing from tube assembly to upper looper eye.

TO THREAD THE NEEDLE

Turn handwheel in operating direction until needles (X, Fig. 1) are in their highest position. Insert needle threads from right to left, through both eyes of needle thread eyelet (AD), under neck of top cover casting; and then down through holes in top cover needle thread eyelet (AC). The right needle thread should be threaded through the right hole and the left needle thread through the left hole of the top cover needle thread eyelet. Thread needles from the front.

THREAD TENSION

The amount of tension on needle and looper threads is regulated by the tension nut (D, Fig. 1). Tension on threads should be only enough to secure proper stitch formation.

PRESSER FOOT PRESSURE

Sufficient presser foot pressure to feed work uniformly should be maintained. Should it be necessary to increase or decrease amount of pressure on presser foot, loosen lock nut (A, Fig. 2) and turn adjusting screw (B). Adjusting screw has a right hand thread so tightening increases pressure, loosening decreases pressure. When pressure adjusting screw (B) has been properly set, tighten lock nut (A). With presser foot resting on throat plate, position locking nut (C) so that its under surface is approximately 1/32 inch to 1/16 inch from the top surface of adjusting screw (B). Set cap (D) against locking nut (C).

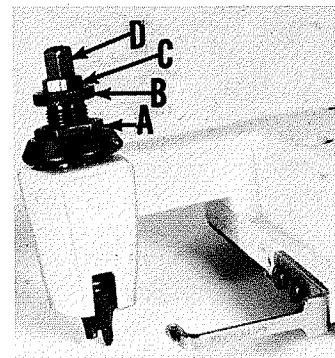

Fig. 2

FEED ECCENTRICS

Feed eccentrics used in Style 39500 FW machines have been selected to produce approximately 10 stitches per inch. It will be noted that the part number of main feed eccentric is No. 39540 B-12 while that of differential feed eccentric is No. 39540 B-10. Minor numbers of the part symbol indicate approximately the number of stitches obtainable when using that eccentric. Unless otherwise specified, machine will be shipped with above combination of eccentrics.

Generally speaking, differential (right hand) feed eccentric determines number of stitches produced; main (left hand) feed eccentric is selected in relation to degree and direction of stretch of material being sewn, or type of operation.

Following stitch number feed eccentrics are available under No. 39540 B-4, -5, -6, -7, -8, -9, -10, -11, -12, -13, -14, -15, -16, -18, -20, -22, -24, -26, -28, -30, -32, -34, -36, -40. Only two eccentrics are supplied with each machine. Additional eccentrics may be ordered separately. To order an eccentric, use No. 39540 B with a minor number suffixed to indicate number of stitches desired. Example: "39540 B-12".

ASSEMBLING AND ADJUSTING SEWING PARTS

Before assembling and adjusting sewing parts, remove cloth plate, fabric guard, chip guard, upper knife assembly, lower knife holder assembly, then follow this suggested sequence:

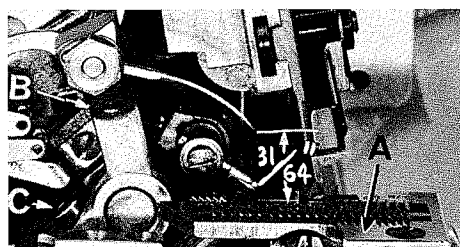

Fig. 3

SETTING THE NEEDLE

With throat plate assembled in position, needles should center in the front end of needle slots. When needles are at high position, needle points should be set 31/64 inch above throat plate (A, Fig. 3). To align needles or set the height above the throat plate, move needle driving arm (B, Fig. 3) by loosening clamp screw (C). Remove throat plate, after needle has been set properly and clamp screw (C) has been tighten.

SETTING THE NEEDLE (Continued)

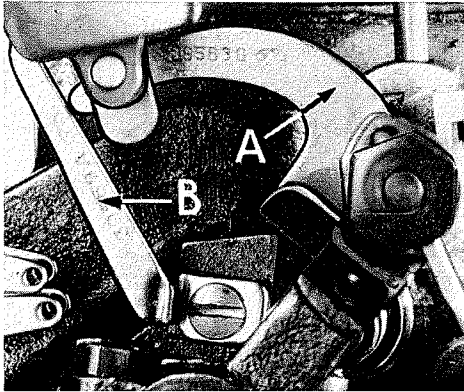

Fig. 4

If needle thread cam pull-off (A, Fig. 4) overlaps looper thread pull-off (B), separate by moving looper thread pull-off back. When retightening looper pull-off screw, be sure to take up end play in needle driving arm.

At this point, insert lower looper (A, Fig. 5) into bar (B). With lower looper at left end of its stroke, set looper point $1/16$ inch from the center of left needle (Fig. 5), using looper gauge No. 21225- $1/16$. Do not have lower looper deflecting needle. Tighten nut (C).

Now assemble differential (front) feed dog.

SETTING THE REAR NEEDLE GUARD

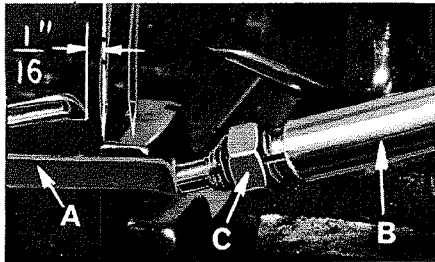

Fig. 5

Set rear needle guard (A, Fig. 6) as high as possible, without interfering with either lower looper or movement of lower knife holder, but still in position to deflect needles forward .002-.004 inch. Screw (B) is used to set rear needle guard. Make sure there is no interference between rear needle guard and lower looper.

SETTING THE LOWER LOOPER

Now finish lower looper adjustment. As lower looper moves to the right, its point should be set into the scarf of the left needle (A, Fig. 7) until the needles spring forward from rear guard surface another .002-.004 inch.

SETTING THE FRONT NEEDLE GUARD

Assemble front needle guard (C, Fig. 6). When lower looper is springing needles off rear needle guard, set front needle guard as close as possible to needle without touching. Screw (D) is used to adjust and set front needle guard. After this setting make sure there is no interference between needle guards and differential feed dog.

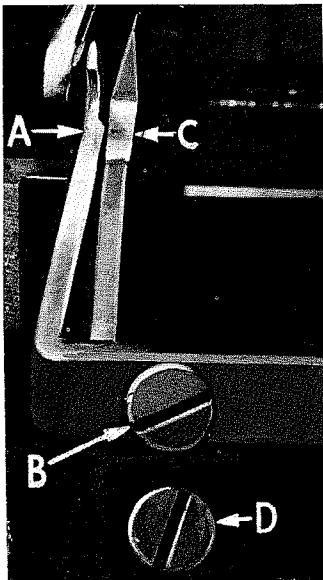

Fig. 6

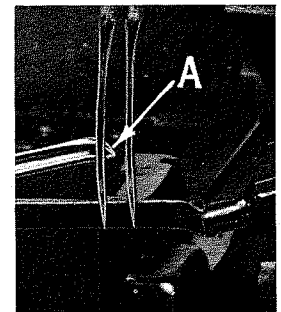

Fig. 7

SETTING THE UPPER LOOPER

Insert upper looper (A, Fig. 8) in its holder. Screw (B) holds upper looper in its holder, and permits it to be pushed in or out, or turned around its shank. Insert upper looper holder into upper looper shaft, if it is not already in place. Screw (C) on clamp holds the upper looper hold-in the shaft. Locate upper looper in its holder so that the shank extends $1/16$ to $3/32$ inch beyond holder.

SETTING THE UPPER LOOPER (Continued)

When the upper looper is at the right end of its stroke, upper looper holder should be set to position upper looper shank back of vertical (Fig. 8). Be sure there is a clearance between heel of looper and casting.



Fig. 9

By adjusting looper holder in or out of upper looper shaft and by turning the looper around its shank, set upper looper point to cross lower looper to the left of the lower looper eye with 0.002 to 0.004 clearance (Fig. 9).

Next, turn the handwheel until upper looper is at the left end of its travel. Check dimensions of upper looper point with respect to the right needle and throat plate (Fig. 10). If resetting is necessary, do it by moving the upper looper holder (A, Fig. 10). Figure 10 represents the correct dimensional setting.

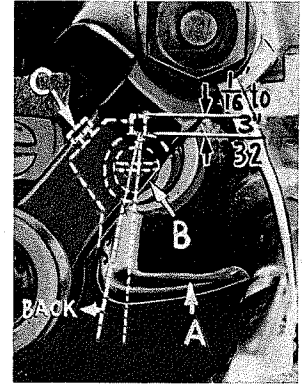

Fig. 8

Dimension $17/32$ inch is increased by turning upper looper holder counterclockwise looking from left end of machine. Dimension $9/64$ inch is increased by pulling upper looper holder to the left, out of the upper looper shaft. After these changes are made, it may be necessary to turn the upper looper around its shank slightly to maintain the condition shown in Fig. 9.

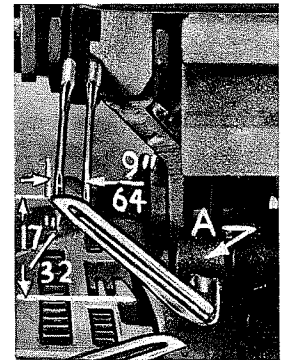

Fig. 10

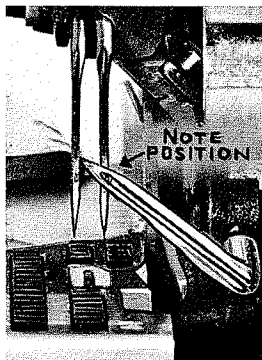

Fig. 11

When the correct setting is obtained, it can be checked quickly as follows: As upper looper is moving to the right and the upper looper eye centers on the right needle, the eyes of the upper looper and needle should align exactly (Fig. 11).

Check setting to avoid interference between upper looper and needle on needle downstroke. If needle rubs the back of upper looper, pull looper out of its holder slightly and rotate looper a short distance counterclockwise, looking from left end of machine. Reset to maintain dimensions of Figs. 9, 10, 11.

SETTING THE FEED DOGS

Assemble the main and differential feed dogs (A, B, Fig. 12). Main and differential feed dogs should be leveled with respect to the throat plate by rotating feed tilting adjusting pin (C). This pin raises or lowers the back end of the feed bar.

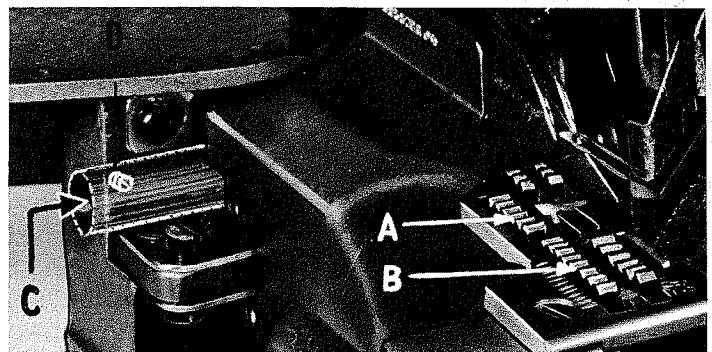

Fig. 12

The feed dogs should be set level at the time the teeth first appear above the throat plate. Screw (D) locks feed tilting adjusting pin in place. With the feed dogs at their highest point of travel, the top of the teeth on the main and differential feed dogs (A, B) should be $3/64$ inch above the throat plate. The chaining feed dog is made as an integral part of the main feed dog.

SETTING THE LOWER KNIFE

Replace lower knife holder assembly. Lower knife (A, Fig. 13) should be set with cutting edge flush with throat plate surface. Adjustments are made with hexagonal head screw which holds lower knife. Lower knife is spring pressed against upper knife, so no lateral adjustment is necessary when width of trim is changed.

Lower knife may be secured in any position by tightening screw (B) and locking nut (C) against support bracket. Because screw (B) also serves as latch pin for the cloth plate latch spring, it should always be locked with nut (C) even when screw is not tightened against lower knife holder.

SETTING THE UPPER KNIFE

Replace upper knife assembly. Clamp upper knife (D, Fig. 13) in position, setting nut (E) to hold clamp (F) in its most clockwise position against upper knife. Upper knife chain guard (J) should be positioned so that the guarding section is approximately 1/64 inch behind the cutting edge and in contact with the top surface of the upper knife.

At the bottom of its stroke, front cutting edge of upper knife should extend not less than 1/64 inch below the cutting edge of lower knife.

After upper knife has been set for the proper width of trim, screw (G) must be tightened to lock the upper knife holding block (H) in place. This will simplify re-setting when upper knife is replaced.

SETTING THE STITCH LENGTH

Length of stitch is determined by the combination of feed eccentrics used. Outer (left) eccentric (A, Fig. 14) actuates main (rear) feed dog; while the inner (right) eccentric (B) actuates the differential (front) feed dog.

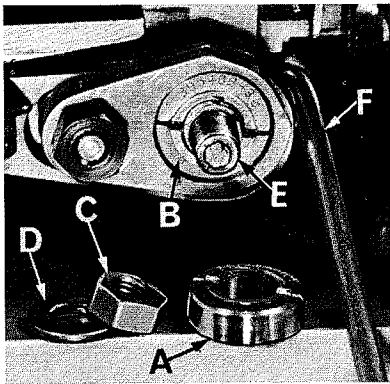

Fig. 14

Using hook-like eccentric extractor (F), supplied with machine, reach behind eccentrics as shown and withdraw eccentrics. It may be necessary to move handwheel back and forth slightly during extraction.

In assembling the feed eccentrics, be sure hubs are facing each other. Be careful not to damage shaft or key. Tighten nut (C) securely.

To change feed eccentrics, remove nut (C) and washer (D) from end of shaft (E). Turn handwheel in operating direction until key slot in eccentric is toward the front. Using hook-like eccentric extractor (F), supplied with machine, reach behind eccentrics as shown and withdraw eccentrics. It may be necessary to move handwheel back and forth slightly during extraction.

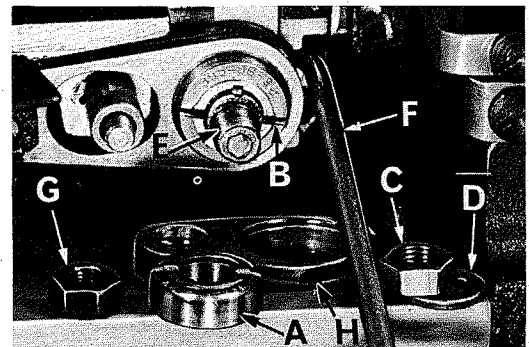

Fig. 15

If eccentrics are unusually tight fitting, in addition to removing nut (C) and washer (D) (Fig. 15) from shaft (E), it may be helpful to remove nut (G) and feed driving connection (H). Then continue as originally suggested.

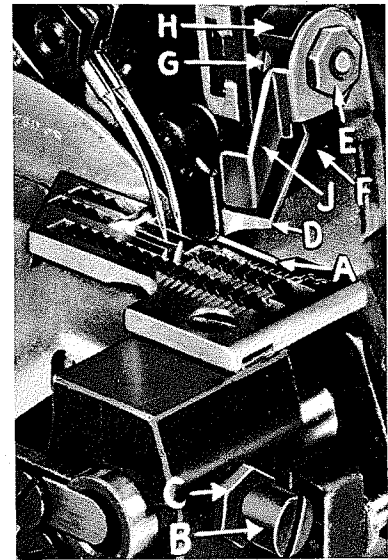

Fig. 13

SETTING THE PRESSER FOOT

Assemble the presser foot to presser arm. With needle in high position, swing presser arm into sewing position and set the presser foot to align needle holes (front and back) and flat on throat plate. The front edge of needle hole in presser foot must be aligned with front edge of needle hole in throat plate. It is also important that the bottom of the presser foot be flat on the throat plate. If necessary, presser foot can be realigned with throat plate slots by shifting the foot lifter lever shaft (H, Fig. 16). To move the shaft, loosen collar screws (B, Fig. 16) and clamp screw (G) and then shift the foot lifter lever shaft to the left or right as required. Retighten collar screws and clamp screws.

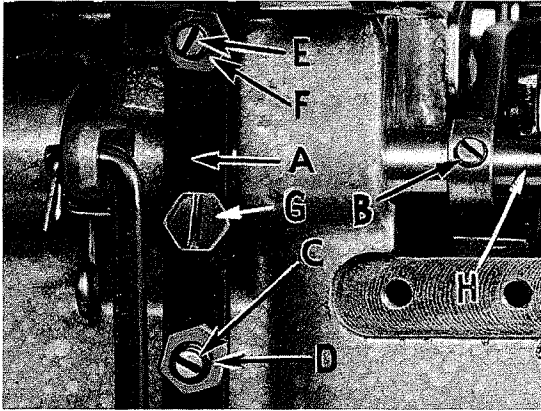

Fig. 16

The foot lifter lever arm (A, Fig. 16) and the collar (B) secure the shaft. Be sure the presser arm does not bind and rise when presser foot release bushing is unlocked. To center presser foot and stitch tongue with respect to throat plate needle hole, loosen presser foot hinge screw.

Adjust lifter lever stop screw (C) so that presser foot can be raised no higher than upper looper will permit: then lock the nut (D). To find this maximum safe position, turn the handwheel so point of upper looper is directly over presser foot tongue. Raise presser foot by depressing the presser foot treadle and manually lower the toe of presser foot. Height adjustment is correct if presser foot tongue does not contact the upper looper. There should be from $1/16$ to $1/8$ inch free motion of foot lifter lever before the presser foot begins to rise. This adjustment is made with screw (E) and locked with nut (F).

Re-assemble chip guard, fabric guard and cloth plate. To make assembly of chip guard easy, turn handwheel until upper knife assembly reaches its highest position.

STARTING TO OPERATE

Be sure machine is threaded according to threading diagram (Fig. 1). With thread tensions light, set looper thread eyelets (N and R, Fig. 1) about horizontal and in the middle of their front to back locations. Operate machine slowly, without presser foot in place, to make sure that chain forms and moves off the tongue freely. Swing presser foot into position, insert material, and sew slowly.

NEEDLE THREAD CONTROL

While sewing on material, check needle thread control as follows: Usually all needle thread is drawn on needle down stroke. At top of needle stroke, thread should be just tight enough to feed chain off stitch tongue. Stitch tends to pull down slightly if excessive thread is pulled on the up stroke. With needle at bottom of stroke, position needle thread eyelet (AD, Fig. 1) so that needle cam pull-off (AE) just contacts needle thread.

LOWER LOOPER THREAD CONTROL

With material under presser foot, set lower looper thread eyelet (R, Fig. 1) back far enough so thread is a little slack when looper thread pull-off (AF) reaches its most rearward position. Looper thread pull-off (AF) is set about 1/8 inch distance behind needle thread cam pull-off (AE). Frame looper thread guide (T) should be set with its eyelet approximately 1/8 inch to the right of lower looper (V) heel eyelet at the time lower looper is at extreme left end of its travel.

While sewing on material, check drawing off of looper thread as follows: A portion of lower looper thread should be drawn through the tension before lower looper thread comes off upper looper. To increase amount of thread drawn through the tension while lower looper thread is on upper looper, move lower looper thread eyelet (R) down, keeping the same amount of pull-off action.

UPPER LOOPER THREAD CONTROL

Before proceeding to adjust upper looper thread eyelet (N, Fig. 1) balance all four tensions to give a normal appearing stitch. Moderate change in these tensions will not markedly effect the purl.

During needle down stroke, forward stroke of looper thread pull-off (AF) will draw upper looper thread through the tension. When normal amount of looper thread is drawn, upper looper thread will have almost all slack taken up as looper thread pull-off reaches its most rearward position.

POSITIONING THE PURL

To move the purl more under the edge, both looper thread eyelets (N and R, Fig. 1) should be raised keeping the same amount of pull-off. Usually it is better to have slightly more pull-off on upper thread than on lower thread.

If it becomes necessary to move looper thread pull-off (AF), be sure to take up all end play in needle drive shaft before tightening. If upper looper is located so that it is higher over throat plate than recommended in (Fig. 10), the purl will tend to form near the top edge. If upper looper is too low, the purl will form nearer the bottom edge.

THREAD TENSIONS

The needle thread tension required is a function of needle thread and material being sewn. In general, lower looper thread tension should be set as high as possible without causing needle thread to be pulled down. Upper looper thread tension should be increased as long as the elasticity of the chain increases, or until the purl is pulled too far over the top.

TERMS

Prices are net cash and subject to change without notice. All shipments are forwarded f. o. b. shipping point. Parcel post shipments are insured unless otherwise directed. A charge is made to cover postage and insurance.

IDENTIFYING PARTS

Where the construction permits, each part is stamped with its part number. On some of the smaller parts, and on those where construction does not permit, an identification letter is stamped in to distinguish the part from similar ones.

Part numbers represent the same part, regardless of catalog in which they appear.

IMPORTANT! ON ALL ORDERS, PLEASE INCLUDE PART NAME AND STYLE OF MACHINE FOR WHICH PART IS ORDERED.

USE GENUINE NEEDLES AND REPAIR PARTS

Success in the operation of these machines can be secured only with genuine Union Special Needles and Repair Parts as furnished by the Union Special Machine Company, its subsidiaries and authorized distributors. They are designed according to the most scientific principles, and are made with utmost precision. Maximum efficiency and durability are assured.

Genuine needles are packaged with labels marked *Union Special* , Genuine repair parts are stamped with the Union Special trade mark. Each trade mark is your guarantee of the highest quality in materials and workmanship.

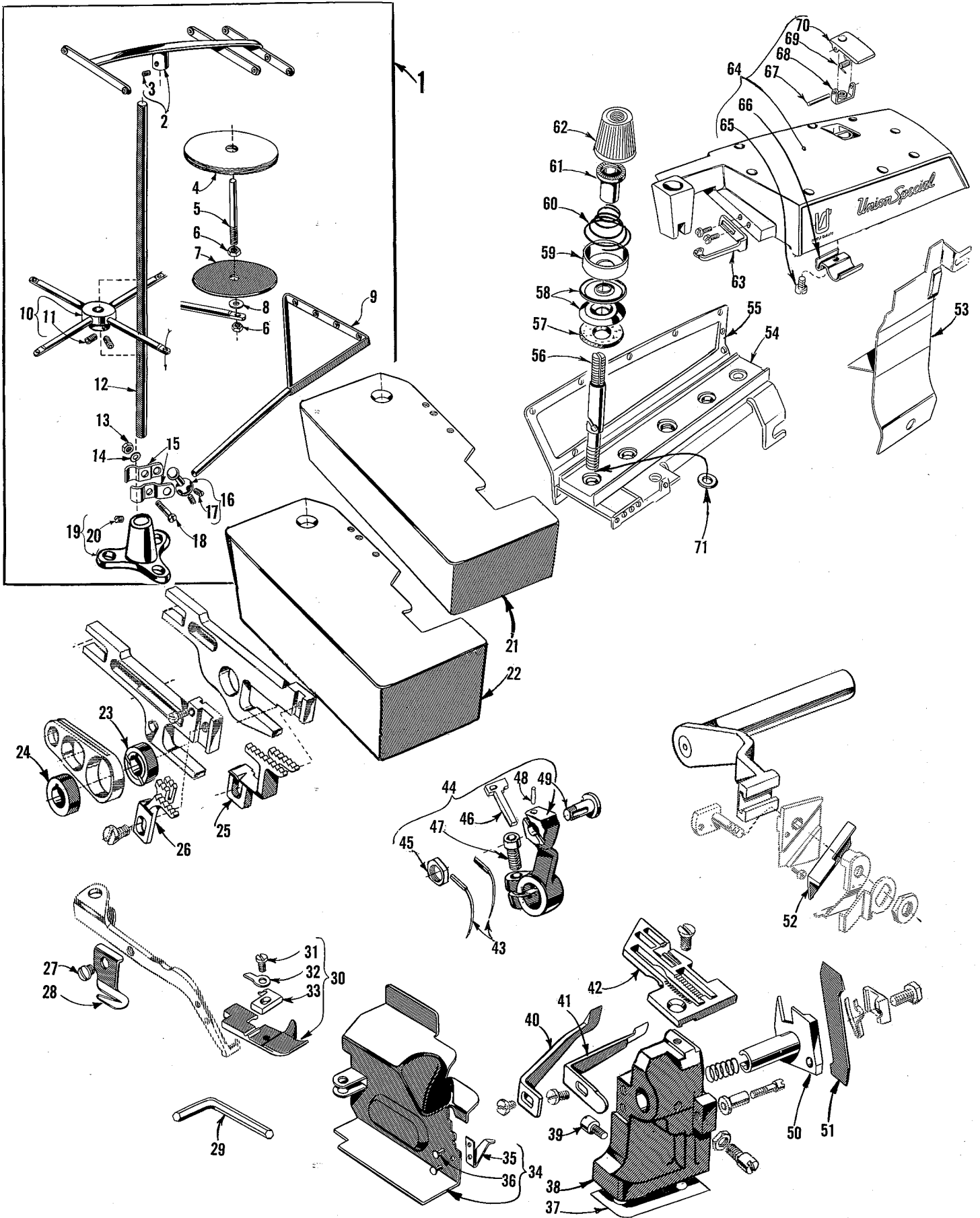

The parts illustrated on the preceding page and described below represent the parts that are used on Style 39500 FW, but not used on Style 39500 FP.

Those parts shown in phantom views and bearing no reference numbers, are common to Styles 39500 FP and FW.

Use Catalog No. 103 FA (Style 39500 FP) for all parts not illustrated or described in this catalog.

Reference numbers that are inside a bracket on the picture plate and have indented descriptions, indicate they are component parts of a complete part or assembly.

Ref. No.	Part No.	Description	Amt. Req.
1	21101 H-4	Thread Stand, complete -----	1
2	21114 H-4	Eyelet Support -----	1
3	22651 CD-4	Screw -----	1
4	21104 V	Pad -----	4
5	21114 W	Spool Pin -----	4
6	258 A	Nut, for spool pin -----	8
7	21114	Spool Seat Disc -----	4
8	652-16	Washer, for spool pin -----	4
9	21114 S-4	Lead Eyelet -----	1
10	21114 D-4	Spool Seat Support -----	1
11	22651 CD-5	Screw -----	2
12	21104 B-20	Thread Stand Rod -----	1
13	21104 H	Nut, for lead eyelet ball split socket -----	1
14	652-16	Washer, for lead eyelet ball split socket -----	1
15	21114 U	Lead Eyelet Ball Split Socket -----	2
16	21114 T	Lead Eyelet Socket Ball -----	1
17	22651 CD-4	Screw -----	2
18	22810	Screw, for lead eyelet ball split socket -----	1
19	21114 A	Thread Stand Base -----	1
20	22651 CD-4	Screw -----	1
21	39501 DC	Cloth Plate, for semi and fully submerged installation -----	1
22	39501 EC	Cloth Plate, for non-submerged installation -----	1
23	39540 B-10	Differential Feed Driving Eccentric -----	1
24	39540 B-12	Main Feed Driving Eccentric -----	1
25	39526 W	Differential Feed Dog, marked "AT", 12 teeth per inch -----	1
26	39505 W	Main Feed Dog, marked "W", 12 teeth per inch -----	1
27	88 A	Screw, for chain cutting knife -----	1
28	39556 K	Chain Cutting Knife -----	1
29	WR56	Allen Wrench, for 1/8 inch hexagon -----	1
30	39520 W	Presser Foot -----	1
31	22768 B	Screw, for hinge spring and stitch tongue -----	1
32	39530	Hinge Spring -----	1
33	39597 W	Stitch Tongue, marked "EF" -----	1
34	39582 GG	Side Cover -----	1
35	39582 H	Spring -----	1
36	39582 J	Rivet -----	2
37	39580 E	Shim, .028 inch thick -----	1
38	39580 AE	Throat Plate and Lower Knife Support Bracket -----	1
39	22585 G	Latch Screw, for side cover -----	1
40	39525 M	Needle Guard, front -----	1
41	39525 G	Needle Guard, rear -----	1
42	39524 W	Throat Plate, marked "AN" -----	1
43	154 GAS	Needle -----	2
44	39552 T	Needle Driving Arm Assembly -----	1
45	14077	Nut, for needle clamp stud -----	1
46	39551 G	Needle Spacer -----	1
47	22596 E	Screw -----	1
48	50-774 Blk.	Stop Pin -----	1
49	39551 F	Needle Clamp Stud -----	1
50	39550 U	Lower Knife Holder -----	1
51	39549 J	Lower Knife -----	1
52	39570 J	Upper Knife -----	1
53	39578 U	Chip Guard -----	1
54	39592 AN	Tension Post Bar -----	1
55	39592 AG-5	Tension Post Mounting Bracket -----	1
56	39592 AL	Thread Tension Post -----	4
57	39592 AF	Tension Disc Felt -----	4
58	39592 AD	Thread Tension Disc -----	8
59	39592 AJ	Spring Shield -----	4
60	39592 AE-4	Tension Spring, for looper threads -----	2
	39592 AE-8	Tension Spring, for needle threads -----	2
61	39592 AK	Tension Spring Ferrule -----	4
62	39592 AA	Tension Nut, green, for right needle thread -----	1
	39592 AB	Tension Nut, blue, for upper looper thread -----	1
	39592 AC	Tension Nut, red, for lower looper thread -----	1
	39592 Z	Tension Nut, yellow, for left needle thread -----	1
63	39563 W	Top Cover Needle Thread Eyelet -----	1
64	39582 AK	Top Cover -----	1
65	22562 A	Screw, for oil guard -----	1
66	39582 W	Oil Guard -----	1
67	51-103 Blk.	Hinge Pin, for oil filler cover -----	1
68	39582 AG	Hinge Bracket -----	1
69	39582 V	Spring, for oil filler cover -----	1
70	39582 AF	Oil Filler Cover -----	1
71	8372 A	Washer, for tension post -----	4

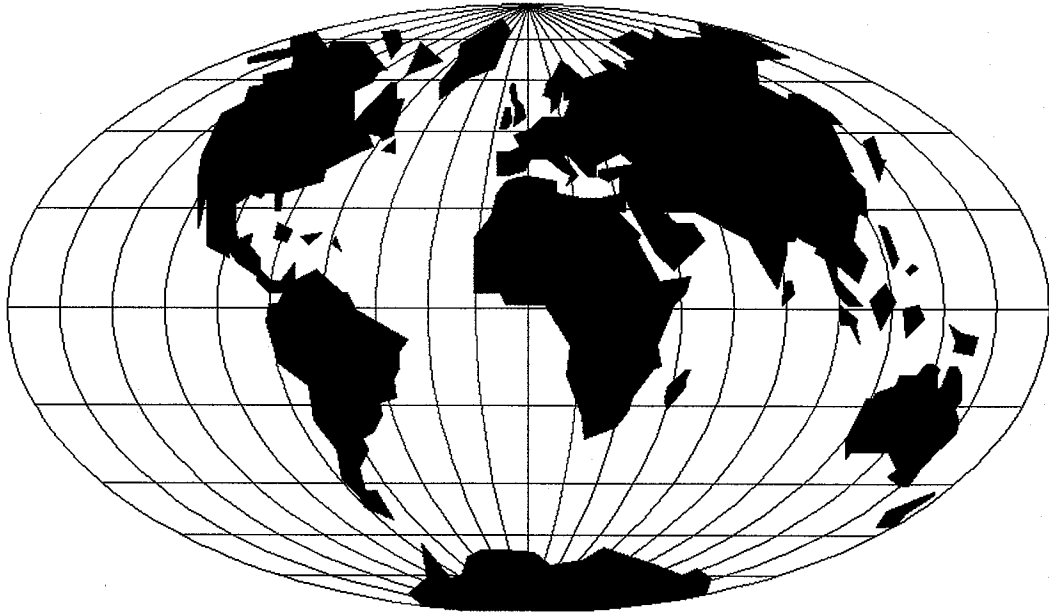

WORLDWIDE SALES AND SERVICE

Union Special Corporation maintains sales and service facilities throughout the world. These offices will aid you in the selection of the right sewing equipment for your particular operation. Union Special Corporation representatives and service technicians are factory trained and are able to serve your needs promptly and efficiently. Whatever your location, there is a qualified representative to serve you.

Corporate Office: One Union Special Plaza
Huntley, IL 60142
Phone: 847•669•5101
Fax: 847•669•4454

European Distribution Center: Union Special GmbH
Raiffeisenstrasse 3
D-71696 Möglingen, Germany
Tel: 49•07141•247•0
Fax: 49•7141•247•100

Brussels, Belgium
Charlotte, N.C.
El Paso, TX
Hong Kong, China
Huntley, IL
Leicester, England
Lille, France
Miami, FL
Milan, Italy
Möglingen, Germany
Montreal, Quebec
Osaka, Japan
Santa Fe Springs, CA

Other Representatives throughout all parts of the world.



Union Special
INDUSTRIAL SEWING EQUIPMENT