

FINEST QUALITY

Union Special[®]

LEWIS • COLUMBIA

**INDUSTRIAL
SEWING
MACHINES**

**STYLE
39500FR**

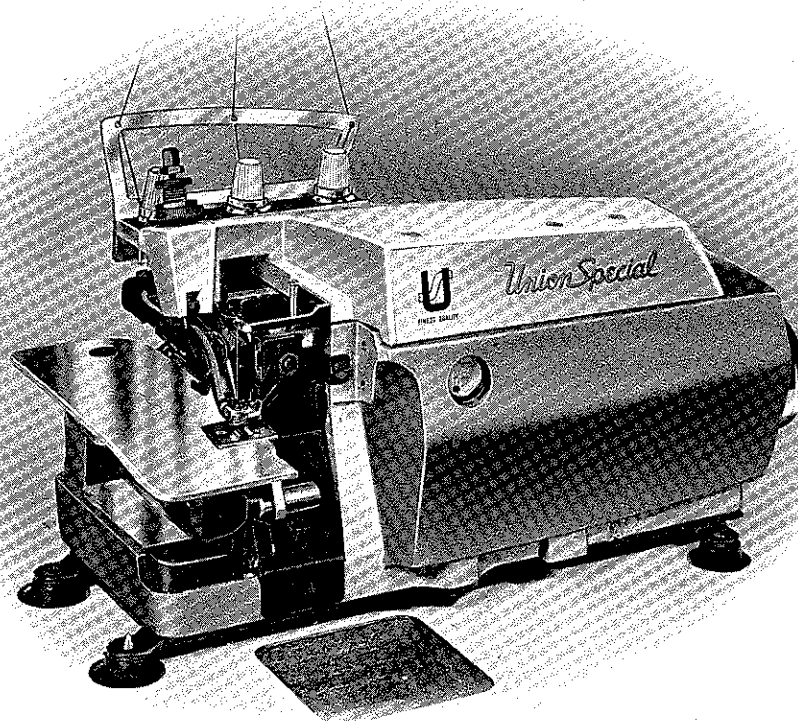

CLASS 39500

**HI-STYLED HIGH SPEED
TWO OR THREE THREAD
HEMMER OR SEAMER**

DIFFERENTIAL FEED MACHINES

**CATALOG
No.
103FR**

Union Special **MACHINE COMPANY**

CHICAGO

Catalog No. 103 FR
(Supplement to Catalog No. 103 FA)

INSTRUCTIONS
FOR
ADJUSTING AND OPERATING

LIST OF PARTS

CLASS 39500

Style
39500 FR

First Edition

Copyright 1967
By
Union Special Machine Co.
Rights Reserved in All Countries

Union Special
MACHINE COMPANY
INDUSTRIAL SEWING MACHINES
CHICAGO

October, 1967

Printed in U. S. A.

IDENTIFICATION OF MACHINES

Each Union Special machine is identified by a Style number on a name plate on the machine. Style numbers are classified as standard and special. Standard Style numbers have one or more letters suffixed, but never contain the letter "Z". Example: "Style 39500 FR". Special Style numbers contain the letter "Z". When only minor changes are made in a standard machine, a "Z" is suffixed to the standard Style number. Example: "Style 39500 FRZ".

Styles of machines similar in construction are grouped under a Class number, which differs from the Style number in that it contains no letters. Example: "Class 39500".

APPLICATION OF CATALOG

This catalog is a supplement to Catalog No. 103 FA and should be used in conjunction therewith. Only those parts used on Style 39500 FR, but not on Style 39500 FP are illustrated and listed at the back of this catalog. On the page opposite the illustration will be found a listing of the parts, with their part numbers, description and the number of pieces required. Numbers in the first column are reference numbers only, and merely indicate the position of that part in the illustration. Reference numbers should never be used in ordering parts. Always use the part number listed in the second column.

NOTE: The threading and adjusting instructions as described in this catalog pertain to the two thread seaming, Type 503 stitch. The threading and adjusting instructions for the three thread seaming, Type 504 stitch, are covered in Catalog No. 103 FA, for Style 39500 FP. The only exception to the above instructions is the height of the needle above the throat plate covered under "Setting The Needle".

This catalog applies specifically to the standard Style of machine as listed herein. It can also be applied with discretion to some Special Styles of machines in Class 39500. References to directions, such as right, left, front, back, etc., are given from the operator's position while seated at the machine. Operating direction of handwheel is away from operator.

STYLE OF MACHINE

Hi-Styled High Speed, Single Curved Blade Needle, One Looper-One Spreader Two Thread and Two Looper Three Thread Overseaming Machine. Differential Feed, Trimming Mechanism with Spring Pressed Lower Knife, Automatic Lubricating System.

39500 FR Medium to heavy duty, four way combination machine, for general utility, two or three thread hemming or seaming of all types and weights of flat, warp and ribbed knit fabrics used on undergarments, outerwear, and similar operations on medium to heavy weight materials. Seam specifications 503 and 504-SSa-1, 503 and 504-EFc-1. Standard seam width 1/8 inch. Stitch range 8-30 per inch. Cam adjusted main and differential feeds. Maximum recommended speed 6500 R. P. M.

OILING

CAUTION! Oil was drained from machine when shipped, so reservoir must be filled before beginning to operate. Oil capacity of Class 39500 is six ounces. A straight mineral oil of a Saybolt viscosity of 200 to 250 seconds at 100° Fahrenheit should be used.

OILING (Continued)

Machine is filled with oil at spring cap in top cover. Oil level is checked at sight gauge on front of machine. Red bulb on oil level indicator should show between gauge lines when machine is stationary.

Machine is automatically lubricated. No oiling is necessary, other than keeping main reservoir filled. Check oil daily before the morning start; add oil as required.

The oil drain plug screw is located at back of machine near bottom edge of base. It is a magnetic screw designed to accumulate possible foreign materials which may have entered the crank case. It should be removed and cleaned periodically.

NEEDLES

Each Union Special needle has both type and size number. The type number denotes the kind of shank, point, length, groove, finish and other details. The size number, stamped on the needle shank, denotes largest diameter of blade, measured in thousandths of an inch, midway between shank and eye. Collectively, type and size number represent the complete symbol which is given on the label of all needles packaged and sold by Union Special.

Class 39500 machines use a curved blade needle. The standard recommended needle for Style 39500 FR is Type 154 GAS. Below is the description and sizes available of the recommended needle.

<u>Type No.</u>	<u>Description and Sizes</u>
154 GAS	Round shank, round point, curved blade, standard length, single groove, struck groove, spotted, chromium plated and is available in sizes 022, 025, 027, 029, 032, 036, 040, 044, 049, 054.

To have needle orders promptly and accurately filled, an empty package, a sample needle, or the type and size number should be forwarded. Use description on label. A complete order would read: "1000 Needles, Type 154 GAS, Size 027".

Selection of proper needle size is determined by size of thread used. Thread should pass freely through needle eye in order to produce a good stitch formation.

Success in the operation of Union Special machines can be secured only by use of needles packaged under our brand name, *Union Special*, which is backed by a reputation for producing highest quality needles in materials and workmanship for more than three-quarters of a century.

CHANGING NEEDLES

Release pressure on presser foot by turning presser foot release bushing (AG, Fig. 1) and swing presser arm (U) out of position. Turn handwheel in operating direction until needle is at its lowest point of travel. Using hexagonal socket wrench No. 21388 AU, furnished with machine, loosen needle clamp nut about 1/4 turn. Again turn handwheel until needle is at high position; withdraw needle.

To replace needle, leave needle holder at high position and, with the flat to the left, insert needle in holder until it rests against stop pin. Keeping needle in this position, turn handwheel until holder is again at its low point of travel; then tighten nut. Return presser arm (U) to position and re-lock presser foot release bushing (AG).

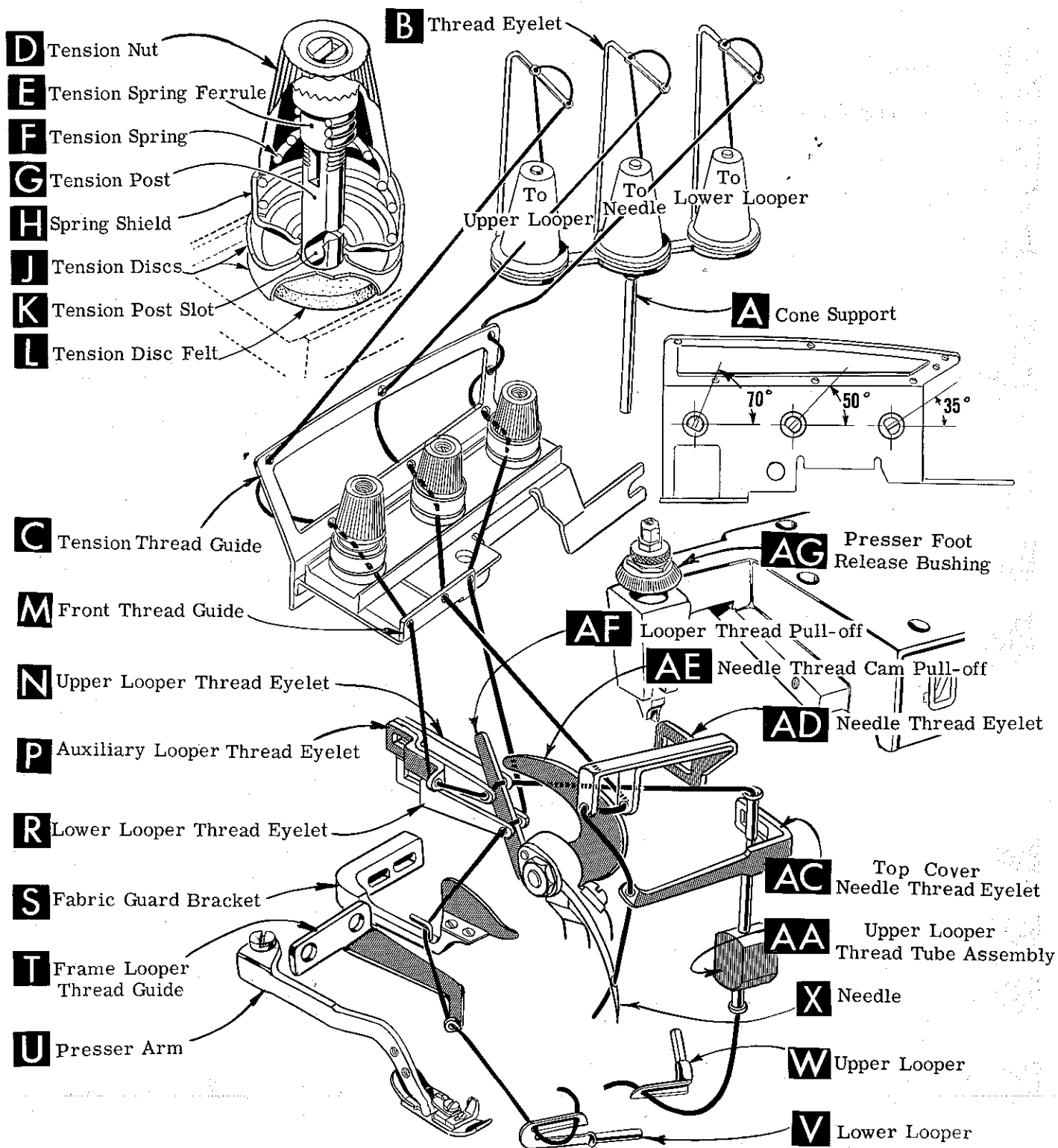

Threading Diagram
 For 504 Stitch

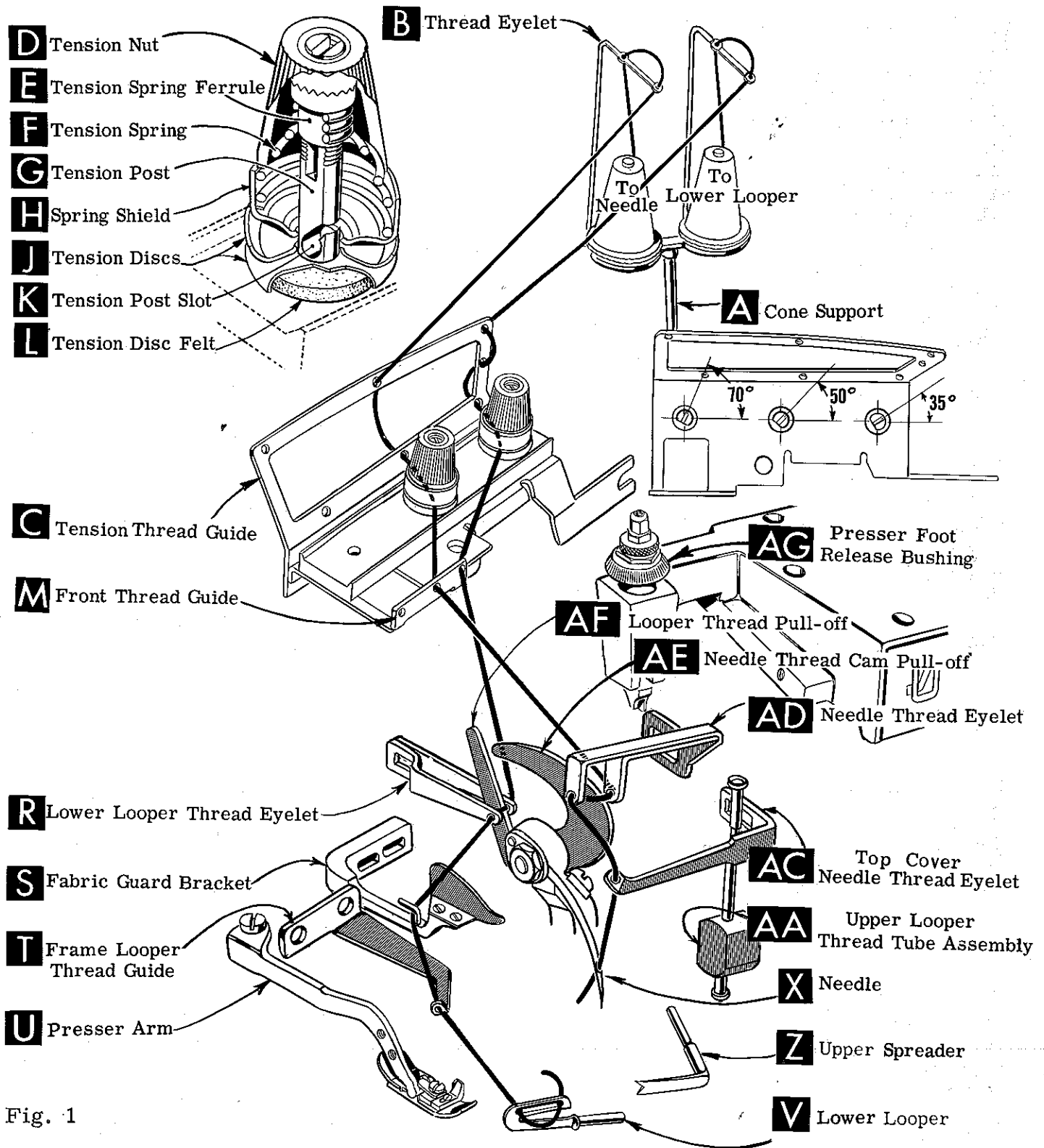

Fig. 1

THREAD STAND

After thread comes from cone on cone support (A, Fig. 1) it is brought up through the back thread eyelet and then down through the front thread eyelet (B). The needle thread is then brought through the upper hole of tension thread guide (C) from front to back and then through the lower hole, from back to front. The lower looper thread is brought through the upper hole of tension thread guide (C) from back to front, through the middle hole from front to back and then through the lower hole from back to front. Both threads then continue between the tension discs (J), through tension post slot (K) in tension post (G) and on through eyelets in front thread guide (M).

THREADING

Only the parts involved in threading the two thread machines are shown in the threading diagram (Fig. 1). Refer to threading diagram Fig. 1, page 6, in Catalog No. 103 FA for the threading the three thread machines. Parts are placed in their relative positions for clarity.

It will simplify the threading of these machines to follow the recommended sequence of threading the lower looper first and the needle second.

Before beginning to thread, swing cloth plate open, turn handwheel in operating direction until needle (X) is at high position, release pressure on presser foot by turning presser foot release bushing (AG) and swing presser arm (U) out of position.

Be sure the threads, as they come from the tension thread guide, are between tension discs (J) and in tension post slots (K) in tension post (G).

TO THREAD LOWER LOOPER

Double end of thread and lead it through both eyes of lower looper thread eyelet (R, Fig. 1) from right to left. NOTE: Thread must pass in front of looper thread pull-off (AF). Lead thread behind fabric guard bracket (S) and through frame looper thread guide (T). Turn handwheel in operating direction until heel of lower looper (V) is all the way to the left; then thread through both eyes from left to right. Left eye of lower looper can be threaded easily if tweezers are in left hand.

TO THREAD THE NEEDLE

Turn handwheel in operating direction until needle (X, Fig. 1) is at its highest position. Insert needle thread from right to left, through both eyes of needle thread eyelet (AD), under neck of top cover casting; and then down through hole in top cover needle thread eyelet (AC). Thread needle from front.

THREAD TENSION

The amount of tension on needle and looper threads is regulated by two knurled tension nuts (D, Fig. 1). Tension on threads should be only enough to secure proper stitch formation.

PRESSER FOOT PRESSURE

Sufficient presser foot pressure to feed work uniformly should be maintained. Should it be necessary to increase or decrease amount of pressure on presser foot, loosen lock nut (A, Fig. 2) and turn adjusting screw (B). Adjusting screw has a right hand thread, so tightening increases pressure, loosening decreases pressure. When pressure adjusting screw (B) has been properly set, tighten lock nut (A). With presser foot resting on throat plate, position locking nut (C) so that its under surface is approximately $1/32$ inch to $1/16$ inch from the top surface of adjusting screw (B). Set cap (D) against locking nut (C).

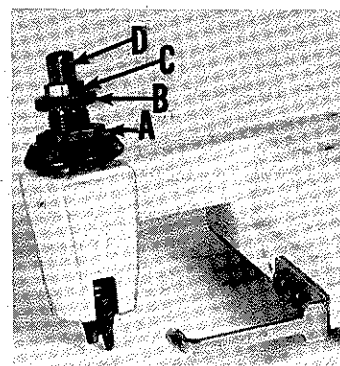

Fig. 2

FEED ECCENTRICS

Feed eccentrics used in Style 39500 FR machines have been selected to produce approximately 12 stitches per inch. It will be noted that the part number of the main feed eccentric is No. 39540 B-14, while that of the differential feed eccentric is No. 39540 B-12. Minor numbers of the part symbol indicate approximately the number of stitches obtainable when using that eccentric. Unless otherwise specified, machine will be shipped with above combination of eccentrics.

Generally speaking, differential (right hand) feed eccentric determines number of stitches produced; main (left hand) feed eccentric is selected in relation to degree and direction of stretch of material being sewn, or type of operation.

Following stitch number feed eccentrics are available under No. 39540 B-4, -5, -6, -7, -8, -9, -10, -11, -12, -13, -14, -15, -16, -18, -20, -22, -24, -26, -28, -30, -32, -34, -36, -40. Only two eccentrics are supplied with each machine. Additional eccentrics may be ordered separately. To order an eccentric, use No. 39540 B with a minor number suffixed to indicate number of stitches desired. Example: "39540 B-14".

ASSEMBLING AND ADJUSTING SEWING PARTS

Before assembling and adjusting sewing parts, remove cloth plate, fabric guard, chip guard, upper knife assembly, lower knife holder assembly, hemming guide assembly; then follow this suggested sequence.

SETTING THE NEEDLE

With throat plate assembled in position, needle should center in the front end of needle slot. When needle is at high position, needle point should be set $17/32$ inch above throat plate (Fig. 3). To align needle or set the height above throat plate, move needle driving arm (A, Fig. 3) by loosening clamp screw (B). Remove throat plate, after needle has been set properly and clamp screw (B) has been tighten.

CAUTION! Needle height must NOT be changed from the $17/32$ inch setting when adjusting for the three thread stitch Type 504, as indicated in Catalog No. 103 FA, for machine Style 39500 FP.

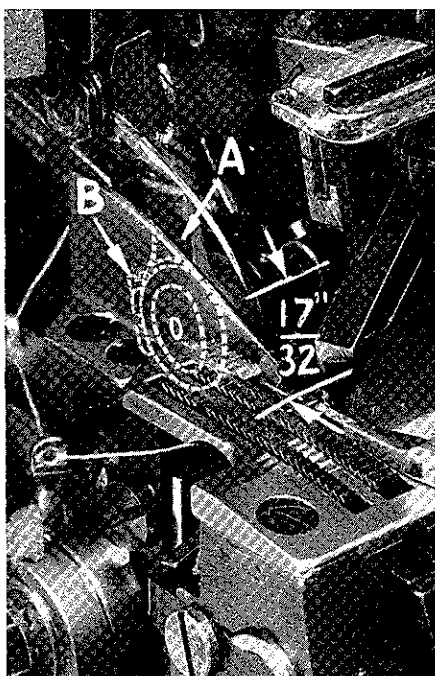

Fig. 3

SETTING THE NEEDLE (Continued)

At this point, insert lower looper (A, Fig. 4) into bar (B). With lower looper at left end of its stroke, set looper point $1/8$ inch from center of needle (Fig. 4) using looper gauge No. 21225- $1/8$. Do not have lower looper deflecting needle. Tighten nut (C). Now assemble differential (front) feed dog.

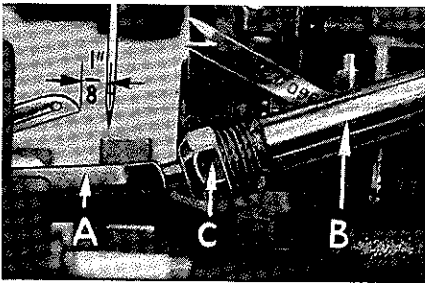

Fig. 4

(B) is used to set rear needle guard. Make sure there is no interference between rear needle guard and lower looper.

SETTING THE LOWER LOOPER OR LOWER SPREADER

Now finish lower looper adjustment. As lower looper moves to the right, its point should be set into the needle scarf (A, Fig. 6) until the needle springs forward from rear guard surface another $.002 - .004$ inch.

SETTING THE FRONT NEEDLE GUARD

Assemble front needle guard (C, Fig. 5). When lower looper is springing needle off back guard, set front needle guard as close as possible to needle without touching. Screw (D) is used to adjust and set front needle guard. After this setting, make sure there is no interference between needle guard and main feed dog.

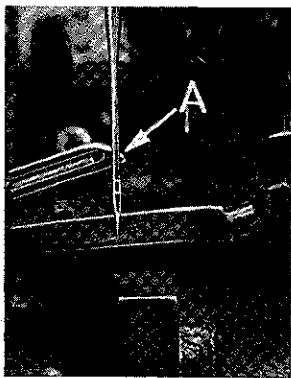

Fig. 6

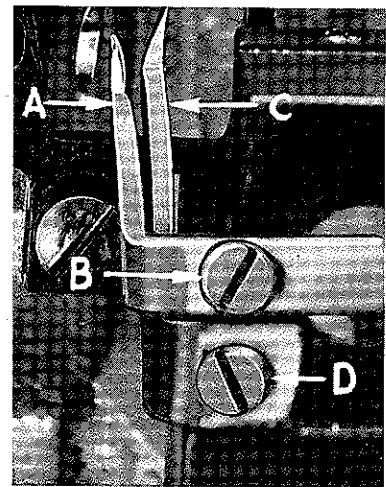

Fig. 5

SETTING THE UPPER SPREADER

Insert upper spreader (A, Fig. 7) in its holder. Screw (B, Fig. 7) holds spreader in its holder, and permits spreader to be pushed in or out, or turned around its shank. Screw (C, Fig. 7) on collar holds spreader holder in the shaft, and allows holder to be rotated or adjusted laterally.

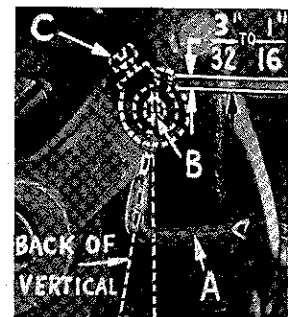

Fig. 7

Preliminary Setting: When spreader is at the right end of its stroke, spreader holder should be set to position spreader shank slightly back of vertical (Fig. 7). Top end of spreader shank should extend $3/32$ to $1/16$ inch above the holder (Fig. 7).

As spreader moves from right to left, the Vee notch of the spreader should pass just behind the eye of the lower looper, with approximately $.002$ inch clearance between spreader and lower looper (Fig. 8).

SETTING THE UPPER SPREADER (Continued).

Turn the handwheel until spreader is at the left end of its travel. At this position, the lower point of the spreader should extend about $\frac{5}{32}$ inch to the left of the centerline of the needle and should be approximately $\frac{1}{2}$ inch above the top of the throat plate (Fig. 9). If resetting is necessary, do it by moving the spreader holder (A, Fig. 9).

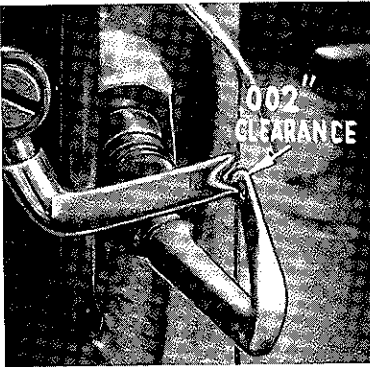

Fig. 8

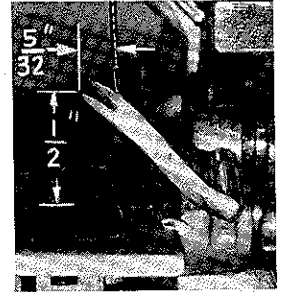

Fig. 9

Now check setting between spreader and needle. If needle rubs the back of spreader, pull spreader out of its holder slightly and rotate spreader holder forward a short distance. These same adjustments, in opposite movement, will reduce the clearance between spreader and needle. Reset to lower looper (Fig. 8).

SETTING FEED DOGS

Now assemble main (back) feed dog (B, Fig. 10) and chaining feed (C). Set all feed dogs (A, B, C, Fig. 10) so the top surfaces of the teeth all lie in the same plane. This can be checked by sighting across the teeth with a straight edge. Now assemble throat plate. Feed dogs should now be leveled with throat plate surface by rotating feed tilting adjusting pin (D). This pin raises or lowers the back end of feed bar.

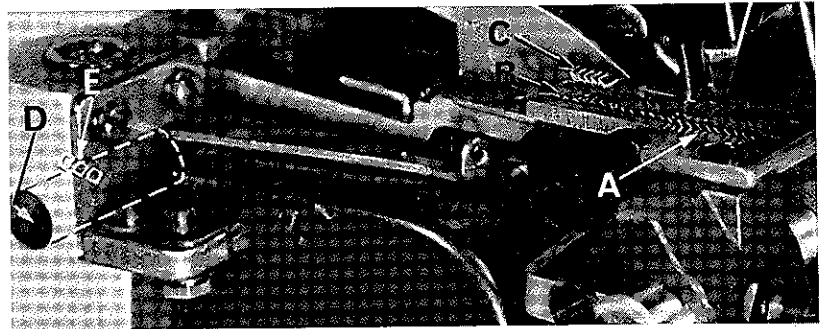

Fig. 10

The feed dogs should be set level at the time the teeth first appear above throat plate. Screw (E) locks feed tilting adjusting pin in place. Now set the main and differential feed dog teeth $\frac{3}{64}$ inch above the throat plate, and chaining feed dog teeth flush with surface of throat plate.

SETTING THE LOWER KNIFE

Replace lower knife holder assembly. In replacing the lower knife holder assembly, tighten screw (A, Fig. 11) so that when the face of the flange on sleeve (B) seats against the throat plate mounting bracket (C) a free lateral motion of the lower knife and holder assembly is obtained when the knife is manually pressed at its upper corner. Lower knife (D) should be set with the cutting edge flush with the throat plate surface. Adjustments are made with hexagonal head screw which holds lower knife. Lower knife is spring pressed against upper knife. So no lateral adjustment is necessary when width of trim is changed.

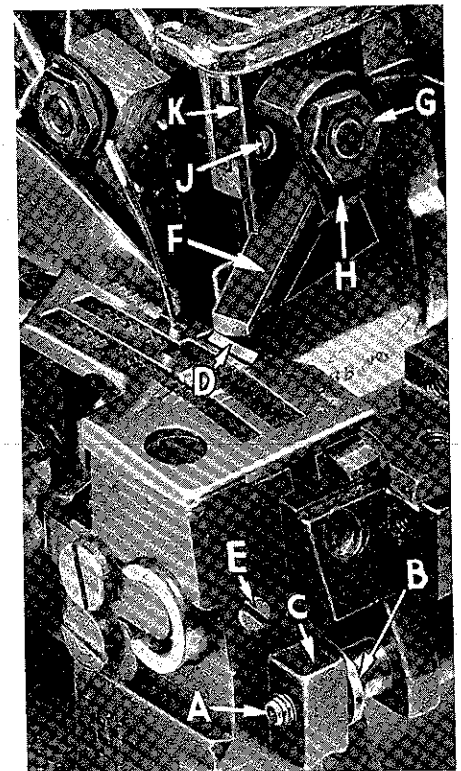

Fig. 11

SETTING THE LOWER KNIFE (Continued)

Lower knife may be secured in any position by tightening screw (E) against knife holder shaft.

Set the desired width of trim by measuring from the right edge of the lower knife to the needle, lock the lower knife holder shaft with screw (E).

SETTING THE UPPER KNIFE

Replace upper knife assembly. Clamp upper knife (F, Fig. 11) in position, setting nut (G) to hold clamp (H) in its most clockwise position against upper knife. At bottom of its stroke, front cutting edge of upper knife should extend not less than 1/64 inch below cutting edge of lower knife. The chain guard should be set down against the upper knife and slightly back from the cutting edge.

After upper knife has been set for proper width of trim, screw (J) should be tightened to lock upper knife holding block (K) in place. This will simplify resetting when upper knife is replaced.

SETTING THE STITCH LENGTH

Length of stitch is determined by the combination of feed eccentrics used. Outer (left) eccentric (A, Fig. 12) actuates main (rear) feed dog; while the inner (right) eccentric (B) actuates the differential (front) feed dog.

In assembling feed eccentrics, be sure hubs are facing each other. Be careful not to damage shaft or key. Tighten nut (C) securely.

To change feed eccentrics, remove nut (C) and washer (D) from end of shaft (E). Turn handwheel in operating direction until key slot in eccentric is toward the front. Using hooked eccentric extractor (F), supplied with machine, reach behind eccentrics as shown and withdraw eccentrics. It may be necessary to move handwheel back and forth slightly during extraction.

If eccentrics are unusually tight fitting, in addition to removing nut (C, Fig. 13) and washer (D) from shaft (E), it may be helpful to remove nut (G) and feed driving connection (H). Then continue as originally suggested.

SETTING THE PRESSER FOOT

Assemble the presser foot to presser arm. With needle in high position, swing presser arm into sewing position and set the presser foot to align needle holes (front and back) and flat on throat plate. The front edge of needle hole in presser foot must be aligned with front edge of needle hole in throat plate. It is also important that the bottom of the presser foot be flat on the throat plate. If necessary, presser foot can be realigned with throat plate slots by shifting the foot lifter lever shaft (H, Fig. 14). To move the shaft, loosen collar screws (B, Fig. 14) and clamp screw (G) and then shift the foot lifter lever shaft to the left or right as required. Retighten collar screws and clamp screw.

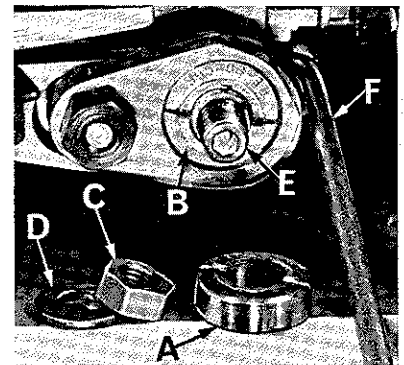

Fig. 12

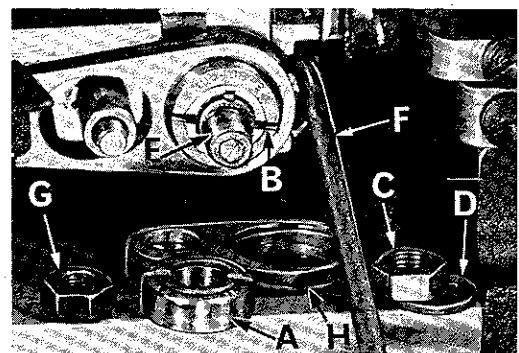

Fig. 13

SETTING THE PRESSER FOOT (Continued)

The foot lifter lever arm (A, Fig. 14) and the collar (B) secure the shaft. Be sure the presser arm does not bind and rise when presser foot release bushing is unlocked.

Adjust lifter lever stop screw (C) so that presser foot can be raised no higher than the upper spreader will permit; then lock the nut (D). There should be from 1/16 to 1/8 inch free motion of foot lifter lever before the presser foot begins to rise. This adjustment should be made with screw (E) and locked with nut (F). Reassemble the chip guard, fabric guard and cloth plate. To assemble chip guard, turn handwheel until upper knife assembly reaches its highest position.

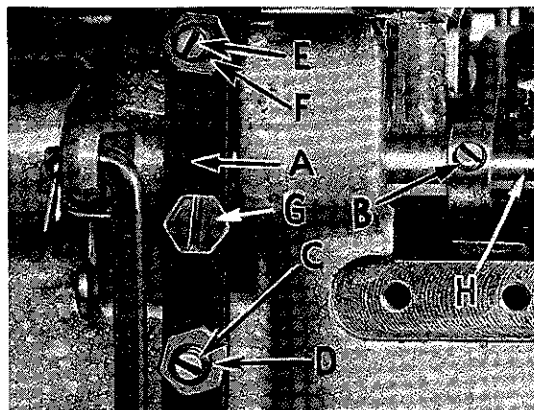

Fig. 14

NEEDLE THREAD CONTROL

While sewing on material, check needle thread control as follows: Usually all needle thread is drawn on needle down stroke. At top of needle stroke, thread should be just tight enough to feed chain off stitch tongue. Stitch tends to pull down slightly if excessive thread is pulled on the up stroke. With needle at bottom of stroke, position needle thread eyelet (AD, Fig. 1) so that needle thread cam pull-off (AE) just contacts needle thread.

LOWER LOOPER THREAD CONTROL

With material under presser foot, set lower looper thread eyelet (R, Fig. 1) back and down far enough so thread is a little slack when spreader reaches its extreme left position. Lower looper thread eyelet (R) should be about horizontal.

Frame looper thread guide (T) should be set with its eyelet approximately 1/8 inch to the right of heel eyelet of looper (V) at the time lower looper is at extreme left end of its travel.

THREAD TENSIONS

Before proceeding, balance both tensions to give a normal appearing stitch. Moderate change in these tensions will not markedly effect the purl.

SPECIAL ADJUSTMENTS

SKIPPING: For occasional skipping, check and/or adjust as outlined below:

1. Recheck lower looper - needle setting. See instructions listed under, "Setting the Needle".
2. Recheck spread - lower looper crossing. See instructions listed under, "Setting the Upper Spreader".
3. Check clearance between needle and spreader. See that spreader moves far enough left past needle.

SPECIAL ADJUSTMENTS (Continued)

Setting 1 and 2 should be made quite carefully. If it can be determined by appearance that skip is definitely not a needle loop skip, reposition lower looper thread eyelet (R, Fig. 1) by lowering it slightly and bringing eyelet holes in close to bend in looper thread pull-off (AF). After this change, increase looper thread tension as much as possible without distorting stitch.

CAUTION: Looper thread must, as before, be slightly slack as spreader reaches its extreme left position, or stitch will appear tight on top side.

STARTING TO OPERATE

Be sure machine is threaded according to threading diagram (Fig. 1).

With thread tensions light, set lower looper thread eyelet (R) about horizontal and in the middle of its front to back location.

Operate machine slowly, with presser foot in place; make sure chain forms and moves off tongue freely.

SETTING THE HEMMING GUIDE SUPPORT BRACKET

Assemble the hemming guide support bracket onto the lower knife support bracket by means of screw (A, Fig. 15). With the knurled adjusting screw (B), set the edge guide (C) so that the left side of its tip is even with and parallel to the right side of the right feed slot in the throat plate.

When the edge guide tip is in this position, the front or leading edge should be slightly to the right of parallel. This adjustment can be made by positioning the stop screw (Ref. 18, page 14) located towards the front of the hinge block and edge guide support bracket (D, Fig. 15).

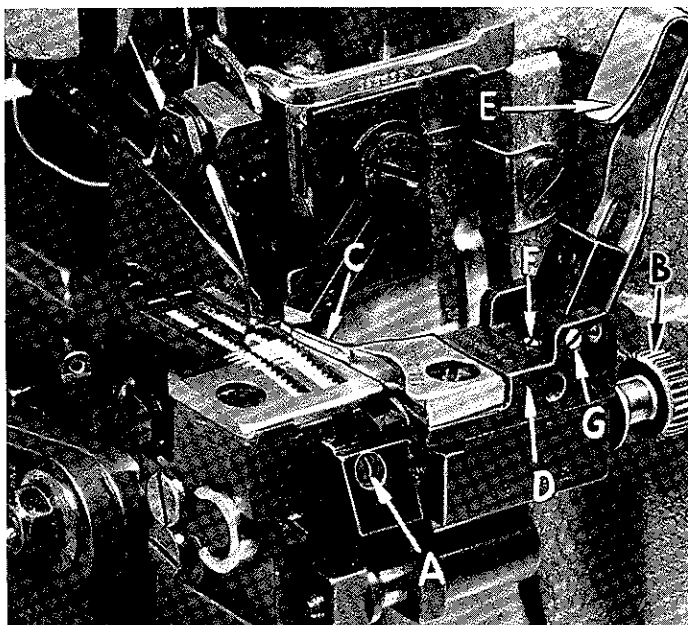
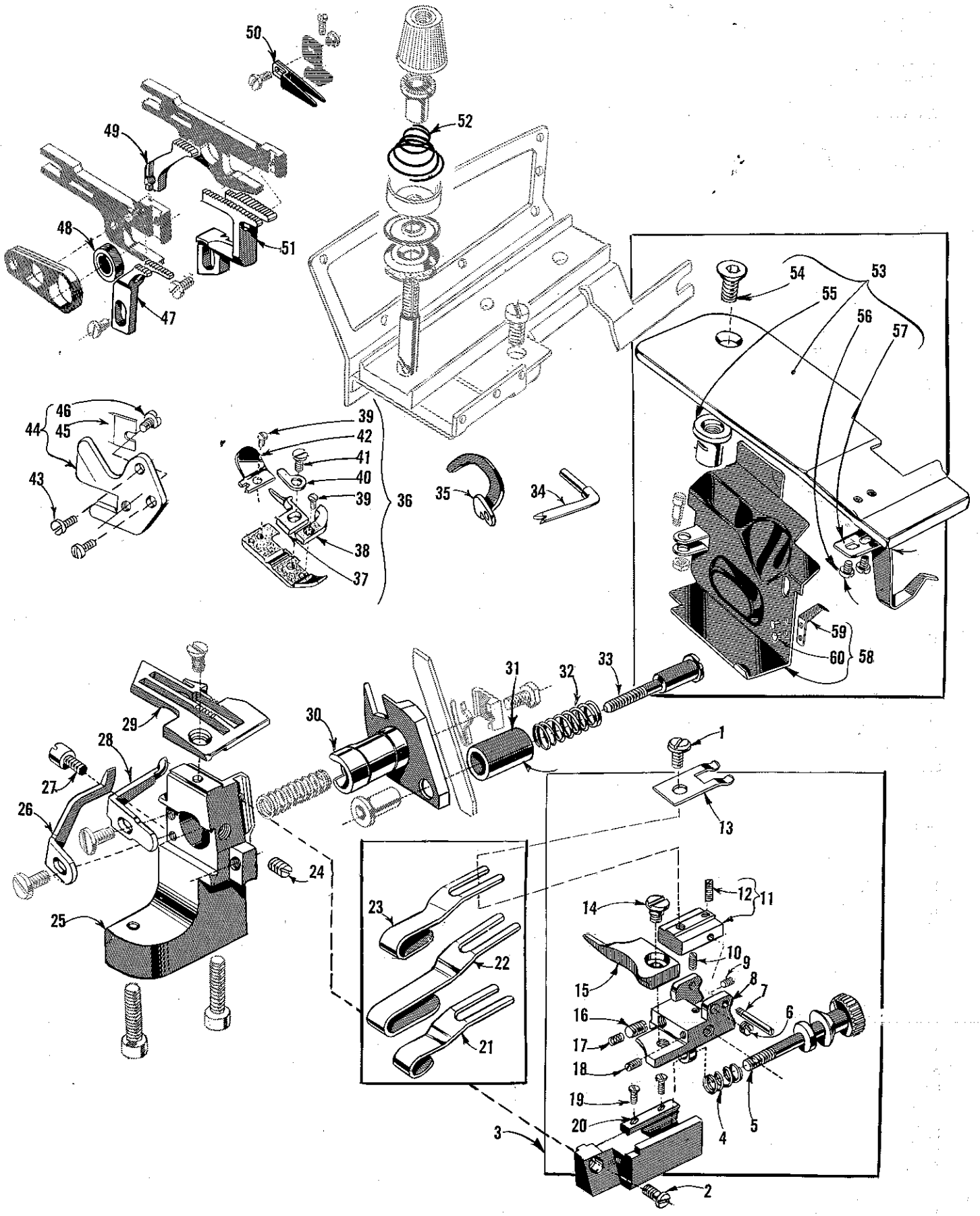

Fig. 15

Under normal conditions, the edge guide is spring pressed to compensate for the differences in material thickness. For example, as in going over seams. The amount of movement and the pressure applied to the edge guide tip is controlled by adjusting the screw (Ref. 16, page 14) which presses against the spring (Ref. 17, page 14) located in the hinge block and edge guide support bracket (D). Removing this spring and turning the screw all the way out against the edge guide prevents movement of the edge guide.

FINAL ADJUSTMENT OF HEMMING GUIDE

Adjust the edge guide (C, Fig. 15) by turning the knurled adjusting screw (B) so that the stitches are located in the folded edge, yet do not show on the face of the fabric. Adjust the overhanging guide (E) so that the space between its guiding edge and the edge guide corresponds with the thickness of the material to be hemmed. Adjust the stop screw (F) for the overhanging guide so that the tip of the overhanging guide is located at the center of the edge guide vertically. If desired, the overhanging guide can be locked into position by tightening the locking screw (G) located in the hinge block and edge guide support bracket (D).



The parts illustrated on the preceding page and described below, represent the parts that are used on Style 39500 FR, but not used on Style 39500 FP.

Those parts shown in phantom views and bearing no reference numbers, are common to Styles 39500 FR and 39500 FP.

Use Catalog No. 103 FA (Style 39500 FP) for all parts not illustrated or described in this catalog.

Reference numbers that are inside a bracket or box on the picture plate and have indented descriptions, indicate they are component parts of a complete part or assembly.

Ref. No.	Part No.	Description	Amt. Req.
1	98 A	Screw, for overhanging guide -----	1
2	22593	Screw, for hemming guide assembly -----	1
3	29481 F	Hemming Guide Assembly -----	1
4	39589 J	Spring -----	1
5	22873 B	Adjusting Screw -----	1
6	22743	Screw -----	1
7	22799 E	Hinge Screw -----	1
8	39589 G	Hinge Block and Edge Guide Support -----	1
9	22565 C	Screw -----	1
10	79077	Screw -----	1
11	39589 F	Overhanging Guide Hinge -----	1
12	77 Q	Screw -----	1
13	39589 U	Hemming Guide Hinge Spring -----	1
14	22760 A	Screw, for edge guide -----	1
15	39503 G	Edge Guide -----	1
16	22565 C	Screw -----	1
17	39568 J	Edge Guide Tension Spring -----	1
18	79077	Screw -----	1
19	22738	Screw -----	2
20	39589 E	Overhanging Guide Base -----	1
21	39589 H-1/2	Overhanging Guide, for 1/2 inch hem -----	1
22	39589 H-1	Overhanging Guide, for 1 inch hem -----	1
23	39589 H-3/4	Overhanging Guide, for 3/4 inch hem -----	1
24	88 B	Screw, for lower knife holder -----	1
25	39580 BA	Throat Plate and Lower Knife Support Bracket -----	1
26	39525 D	Needle Guard, front -----	1
27	22585 G	Screw, for locking side cover -----	1
28	39525 E	Needle Guard, rear -----	1
29	39524 G	Throat Plate, marked "AF" -----	1
30	39550 T	Lower Knife Holder -----	1
31	39550 K	Spring Cover -----	1
32	39550 J	Knife Pressure Equalizing Spring -----	1
33	22559 H	Adjusting Screw -----	1
34	39560 A	Upper Spreader, for two thread seaming -----	1
35	39563 J	Needle Thread Cam Pull-off -----	1
36	39520 G	Presser Foot -----	1
37	39597 F	Stitch Tongue, marked "DV" -----	1
38	39530 B	Chip Guard -----	1
39	22738	Screw, for chip guard and chain shield -----	2
40	39530	Presser Foot Hinge Spring -----	1
41	22768 B	Screw, for stitch tongue and hinge spring -----	1
42	39530 E	Chain Shield -----	1
43	605	Screw, for chain cutting knife -----	2
44	39556 M	Chain Cutting Knife -----	1
45	39556 L	Chain Cutter Blade -----	1
46	22798	Screw, for chain cutter blade -----	1
47	39505 F	Main Feed Dog, marked "F", 20 teeth per inch -----	1
48	39540 B-14	Main Feed Driving Eccentric -----	1
	39540 B-12	Differential Feed Driving Eccentric -----	1
49	39505 G	Chaining Feed Dog, marked "S", 20 teeth per inch -----	1
50	39568 B	Looper Thread Eyelet, used in top position for two thread seaming -----	1
51	39526 H	Differential Feed Dog, 20 teeth per inch -----	1
52	39592 AE-4	Looper Thread Tension Springs, for three thread seaming -----	2
	39592 AE-8	Needle Thread Tension Spring, for three thread seaming -----	1
	39592 AE-5	Looper and Needle Thread Tension Spring, for two thread seaming -----	2
53	39501 AP	Cloth Plate -----	1
54	22657 D-12	Screw -----	1
55	39501 K	Cloth Plate Stud -----	1
56	22513	Screw, for latch spring -----	2
57	39532 D	Latch Spring -----	1
58	39582 G	Side Cover -----	1
59	39582 H	Spring -----	1
60	39582 J	Rivet -----	2



Union Special[®]
INDUSTRIAL SEWING MACHINES

UNION SPECIAL maintains sales and service facilities throughout the world. These offices will aid you in the selection of the right sewing equipment for your particular operation. Union Special representatives and service men are factory trained and are able to serve your needs promptly and efficiently. Whatever your location, there is a Union Special Representative to serve you. Check with him today.

ATLANTA, GA.

BOSTON, MASS.

CHICAGO, ILL.

DALLAS, TEXAS

LOS ANGELES, CAL.

NEW YORK, N. Y.

PHILADELPHIA, PA.

MONTREAL, QUEBEC

BRUSSELS, BELGIUM

LEICESTER, ENGLAND

LONDON, ENGLAND

PARIS, FRANCE

STUTTGART, GERMANY

Representatives and distributors in all important industrial cities throughout the world.

Union Special

MACHINE COMPANY

400 N. FRANKLIN ST., CHICAGO, ILL. 60610