

I N S T R U C T I O N M A N U A L

f o r

S I N G E R

M A C H I N E

7 2 2 5 J

THE SINGER COMPANY

Contents

Application	1
Notes on Safety	1
Commissioning	1
Oiling	2
Eye Guard	3
Operation of Machine	4,5
Belt Guard	6
Inserting the Needle	6
Winding the Bobbin	6
Threading and Inserting the Bobbin Case	7
Threading the Needle	7
Regulating the Needle Thread Tension	8
Regulating the Bobbin Thread Tension	8
Regulating the Pretension	8
Machine Care	8
Specifications	9

Application

Semi-automatic jeans pocket setter
for attaching hip pocket on jeans

Notes on Safety

- . The machine must only be commissioned in full knowledge of the instruction manual and operated by persons with appropriate training.
- . Before putting into service also read the safety notes and the instruction manual of the motor supplier.
- . The machine must be used only for the purpose intended.
Use of the machine without the safety devices belonging to it is not permitted.
- . When gauge parts are exchanged (e.g. needle, presser foot, needle plate, feed plate and bobbin), during threading, when the workplace is left, and during service work, the machine must be isolated from the mains by switching off the ain switch or disconnection the main plug.
- . When changing the pocket clamp, the main switch and air supply must be turned off.
- . When machine is in operation, do not touch the feed system (pocket clamp mechanism) because there is danger of injury.
- . General servicing work must be carried out only by appropriately trained persons.
- . Repairs, conversion and special maintenance work must only be carried out by technicians or persons with appropriate training.
- . For service or repair work on pneumatic systems the machine must be isolated from the compressed air supply system. Exceptions to this are only adjustments and function checks made by appropriately trained technicians.
- . Work on the electrical equipment must be carried out only by electricians or appropriately trained persons.
- . Work on parts and systems under electric current is not permitted, except as specified in regulations EN50110.
- . Conversions or changes to the machine must be made only on adherence to all safety regulations.
- . For repairs, only replacement parts approved by us must be used.
- . Commissioning of the sewing head is prohibited until such time as the entire sewing unit is found to comply

Meanings of the symbols:



Danger spot!
Items requiring special attention.



Danger of injury to
operative or service staff

Be sure to observe and
adhere to these safety
notes!

Commissioning



To avoid disturbances or
damage it is absolutely
necessary to observe the
following instructions:

- . Before you put the machine into operation for the first time clean it thoroughly, and oil it well (see page 2).
- . Have the mechanic check whether the motor can be used with the existing main voltage or not, and that junction box is correctly connected. Do not start the machine if the voltage is not correct!

Oiling

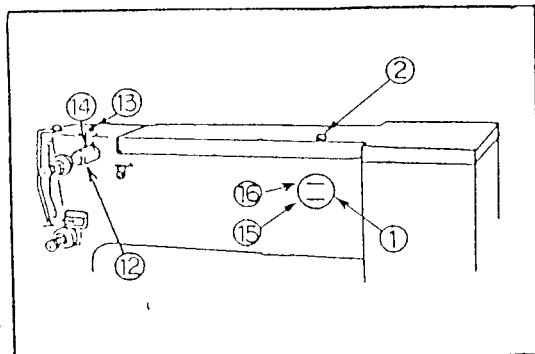

When oil in oil window ① is at low mark ⑮ , fill to high mark ⑯ from oil hole ② .
In new machines or those that have been idle for long time, adequately lubricate ③ , ⑥ - ⑪ needle bar and thread take-up components and oil wicks in various places.

When oil in oil window ④ is at low mark ⑰ , fill to high mark ⑱ from oil hole ⑤ .

Remove shuttle bobbin case, shuttle race ring and shuttle body from shuttle race body and clean the parts once every day.

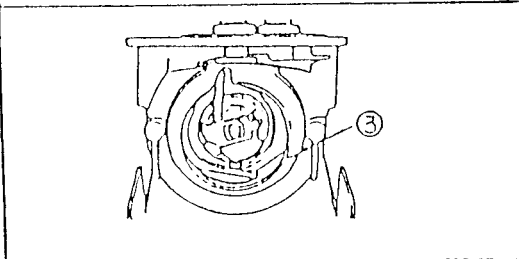

When thread lubricating reservoir ⑫ is used, fill with silicone oil from oil hole ⑬ . In this case, check to see silicone oil sticks to needle thread passed through thread guide ⑭ .

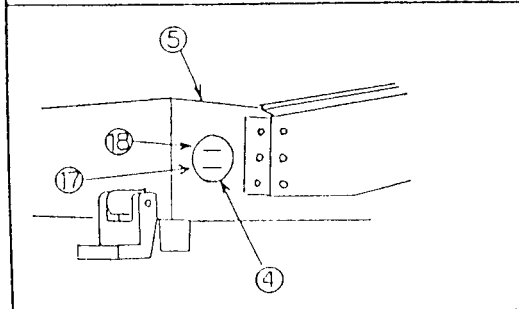

Only use oil with a viscosity of 20.0 mm²/sec. at 38 C and a density of 0.888 g/cm³ at 15 C.

We recommend SINGER C-Oil.

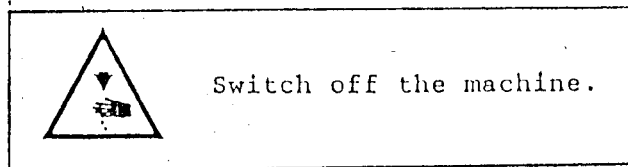
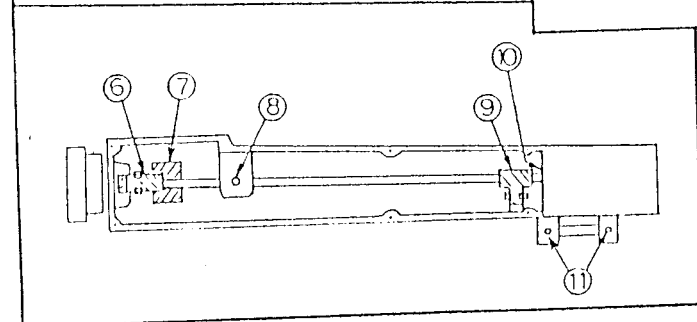

Eye Guard

Assemble eye guard to face plate with screw ① as shown in the sketch.

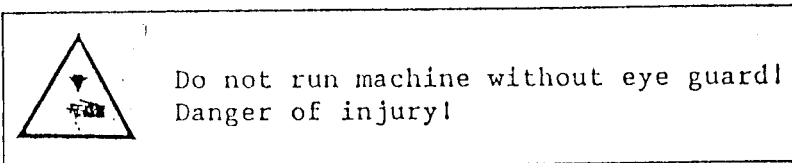
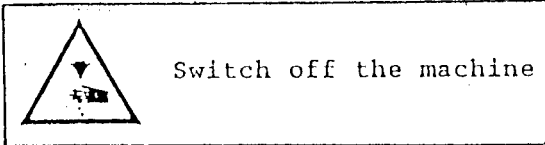
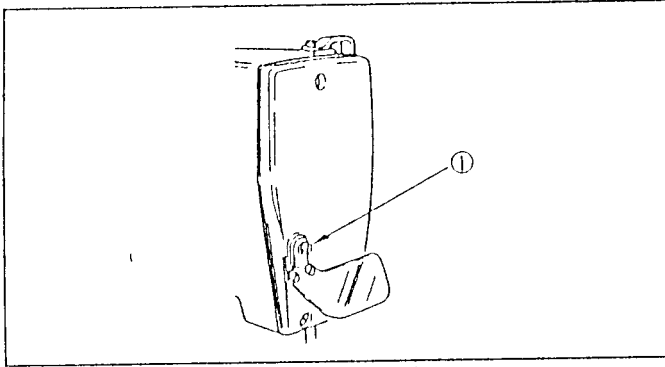

Operation of Machine

Operate the machine in accordance with following procedure.

1. Supply air.

Normally, the air pressure should be set to 0.5 MPa (= 5 kgf/cm²).

2. Turn on main switch.
3. Following will be displayed on LCD screen.

```
MEM.CHK&PRG.LOAD
WAIT 12 SEC
```

Wait 12 seconds.

4. Following will be displayed on LCD screen.

```
AFTER MOVE WORK
PUSH ORG.POS KEY
```

5. Push [ORG.POS] key.

Following will be displayed on LCD screen.

```
MOVE OK?
ORG.POS
```

6. Push [DEL] key.

Move pocket clamp to a position where it can be returned to original position with the cursor (see sketch).

7. Push [ENTER] key

Pocket clamp will move to original position, then it will rise and inverse clamp will move forward.

8. Following will be displayed on LCD screen.

```
0: SEWING MODE
1: PATTERN MODE
```

9. Push [0] key.

10. Following will be displayed on LCD screen.

```
INPUT PATTERN
NAME: _
```

11. Input pattern name.



Keep fingers away from pocket clamp!
Danger of injury!

When returning the work piece to original position, be sure to move the work piece to a position where pocket clamp will not run into any obstruction.

If work piece is returned to original position without making sure there is no danger of interference, it may result in malfunction or damages to the machine.

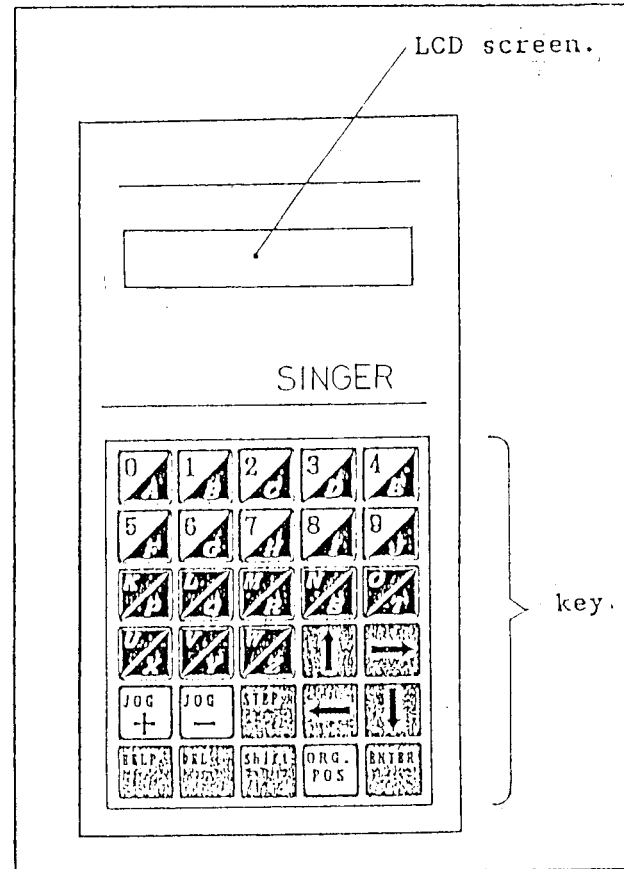

12. Place material in position on the machine and turn on outer clamp and inner clamp switches to lower the pocket clamp.
 (Machine will not sew unless both outer and inner clamps have been lowered.)

13. Push start switch.

Machine will start sewing.

When pattern is completed, the thread will be trimmed and pocket clamp will return to original position and machine will stop completing one cycle.

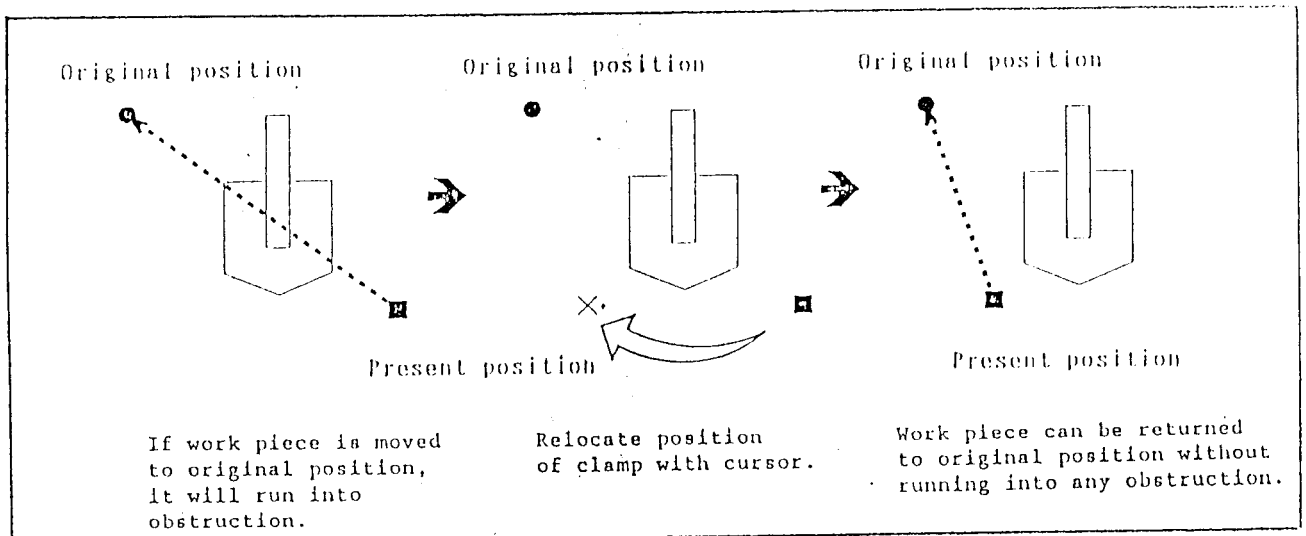
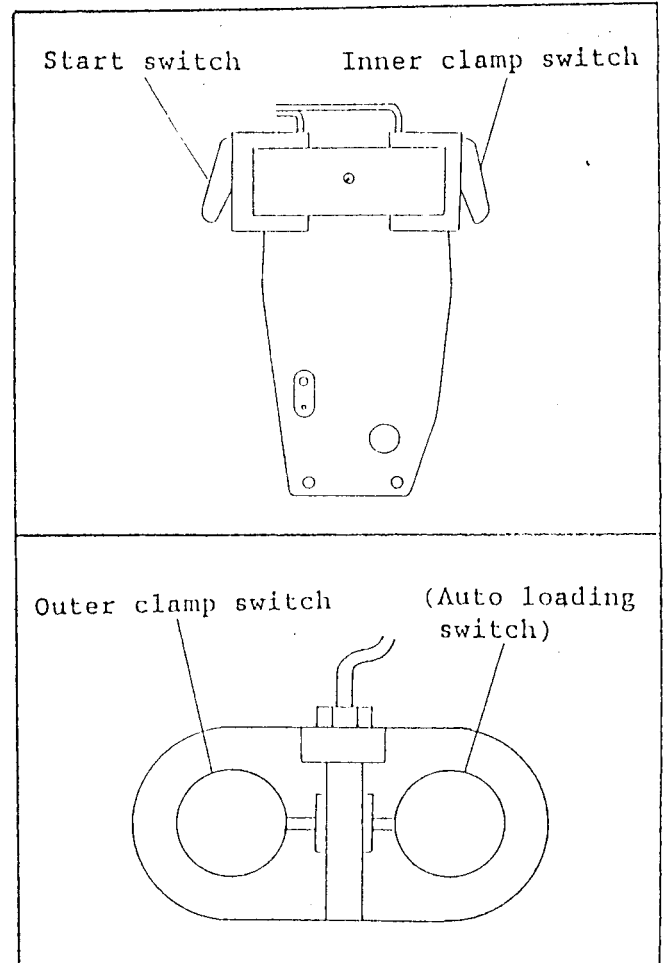

Belt Guard

- Belt guard is assembled to the machine head when machine leaves the factory. For protection against danger, the belt guard should not be removed when operating the machine.

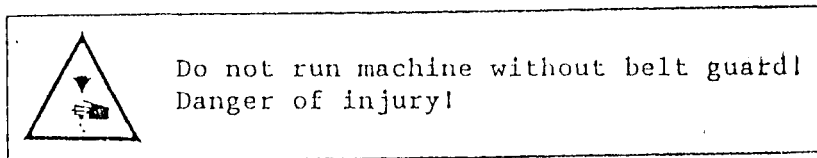

Inserting the Needle

Use Cat. 3651-05 (MR4.0) needle only.

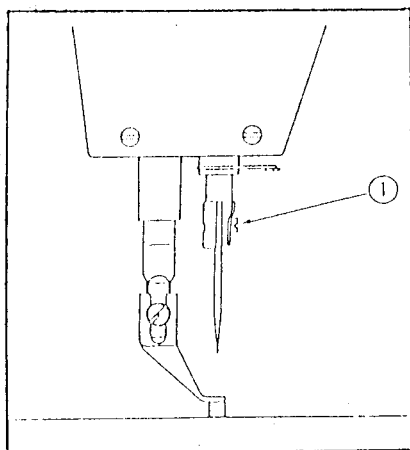

Set the needle bar at its highest point. Loosen needle set screw ①. Insert the needle in the needle holder and push it up as far as it will go. Make sure its long groove faces toward the front. Tighten needle set screw ① securely.

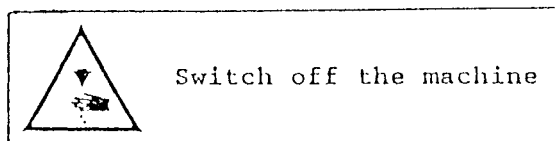

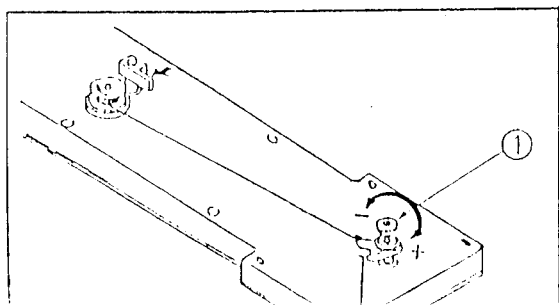

Winding the Bobbin

Adjust the thumb nut ① to regulate the tension for bobbin winding.

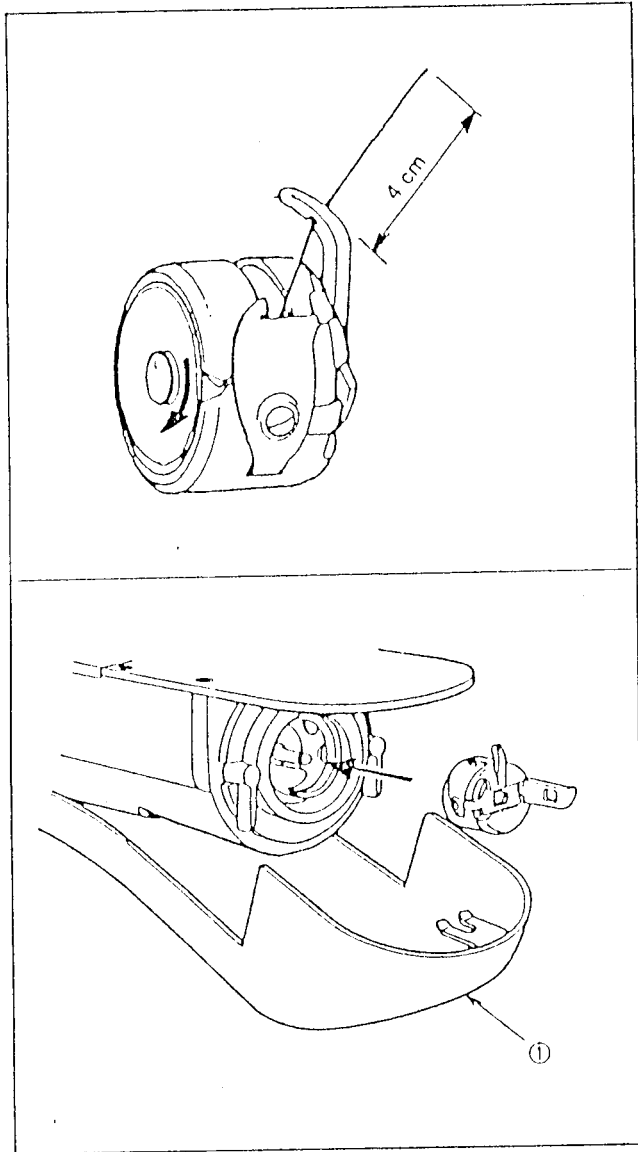

Threading and Inserting the Bobbin Case





 Switch off the machine.

 Do not operate without cylinder cover ①!
Danger of injury!

Threading the Needle

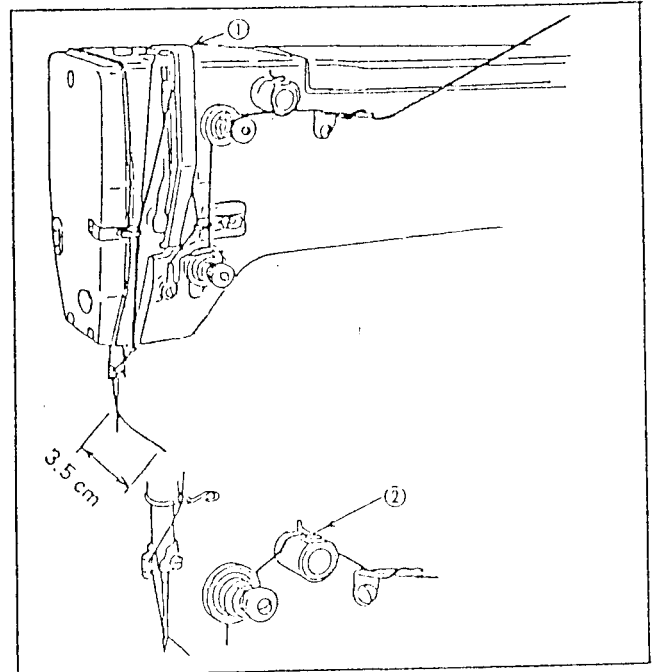
Thread needle from front to back.
When using silicone oil, pass thread through thread guide ②.



 Switch off the machine.

 Do not run machine without take-up lever guard ①.
Danger of injury!

Regulating the Needle Thread Tension

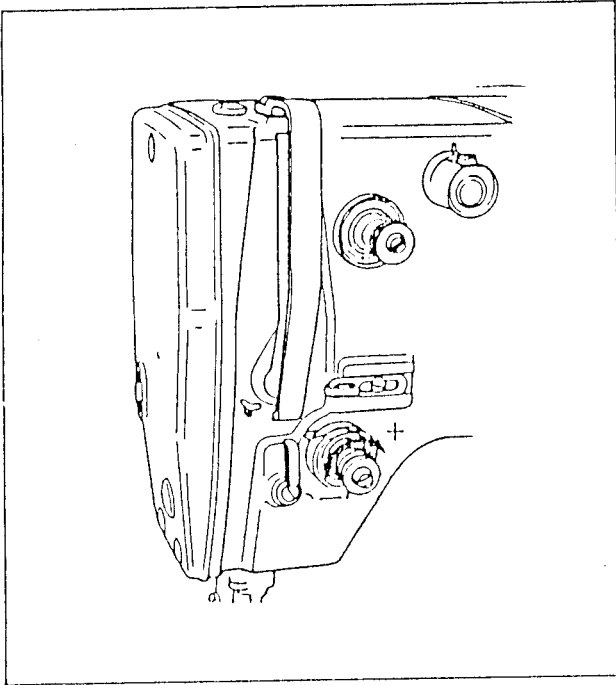

Regulating the Pretension

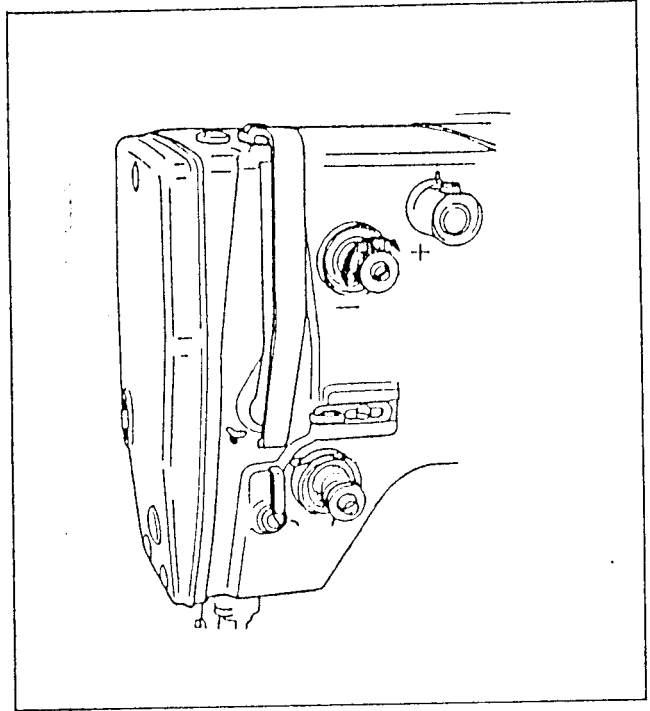

Regulating the Bobbin Thread Tension

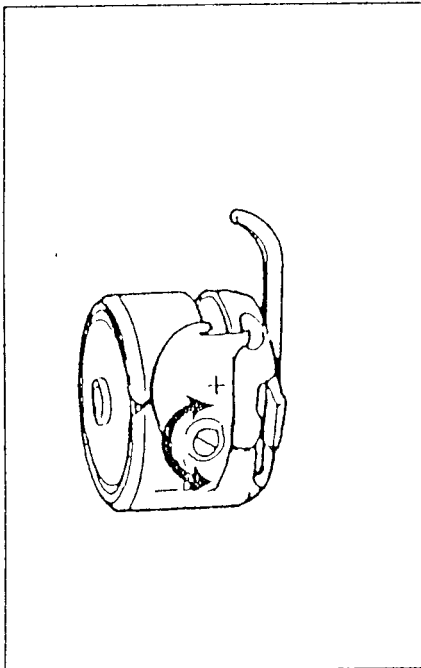

Machine Care

Clean hook and hook area daily, or more frequently if machine is in continuous operation.



Set machine upright again using both hand. Danger of crushing between sewing head and table top.



Switch off the machine.

Specifications

Stitch type: 301 (lockstitch)

Maximum speed: 2,300 s.p.m. (at 3.0mm stitch length)

Stitch length: 0.1 to 10mm

Maximum sewing window: Max. across arm (X): 250mm
Max. up arm (Y): 190mm

Maximum clamp lift: 30mm

Needle: Cat. No. 3651-05 (MR4.0)

Shuttle: 1.7 times shuttle

Motor Pulley Dia: 60mm

Memory Medium: 2HD 3.5" floppy disk

Total Number of Stitches: 80,000 stitches

Electricity: AC200, 220, 240V \pm 10% 1 ϕ 50/60Hz 1KVA

Air Pressure: 5 - 6 kgf/cm² (0.49 - 0.59 MPa)

Air Consumption: 3Nl/min.

Overall dimensions: 1,284mm (L) X 1,200mm (W) X 1,210mm (H)

Weight: 190 kg

Option

- . Stacker
- . Auto-loading device
- . Creasing unit
- . Needle thread breakage detector
- . Air-blow parts for label attaching.