

**SINGER**  
**99W110,W111,W112,W113**

# INSTRUCTIONS

FOR USING AND ADJUSTING

## SINGER\* SEWING MACHINES

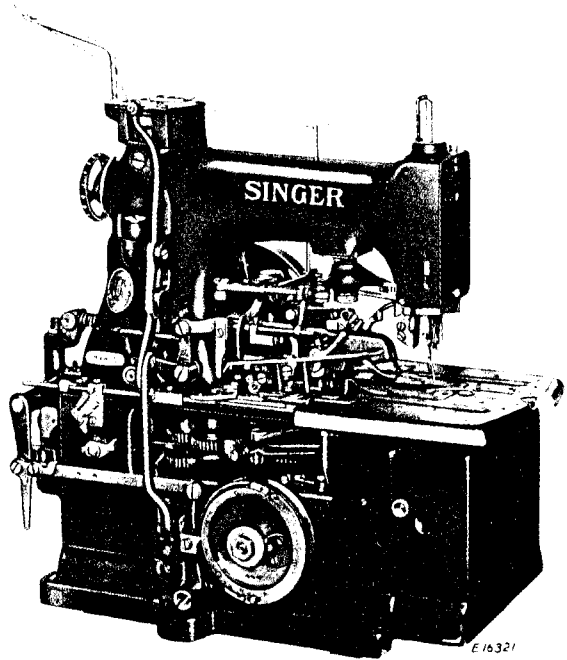

99w110, 99w111, 99w112  
AND 99w113

\*A TRADE MARK OF

THE SINGER MANUFACTURING COMPANY

## TO ALL WHOM IT MAY CONCERN:

The improper placing or renewal of the Trade Mark "SINGER" or any other of the Trade Marks of The Singer Manufacturing Company (all of which are duly Registered Trade Marks) on any machine that has been repaired, rebuilt, reconditioned, or altered in any way whatsoever outside a SINGER factory or an authorized SINGER agency is forbidden.

### THE IMPORTANCE OF USING **SINGER**\* PARTS AND NEEDLES IN **SINGER** MACHINES

The successful operation of SINGER machines can only be assured if SINGER parts and needles are used. Supplies are available at all SINGER Shops for the Manufacturing Trade, and mail orders will receive prompt attention.

SINGER Needles should be used  
in SINGER Machines.  
These Needles and their Containers  
are marked with the  
Company's Trade Mark "SIMANCO.\*" 1

Needles in Containers marked  
"FOR SINGER MACHINES"  
are NOT **SINGER** made needles. 2

Copyright, U. S. A., 1921, 1922, 1924, 1925, 1926, 1927, 1932, 1934, 1936,  
1937 and 1942, by The Singer Manufacturing Company  
All Rights Reserved for all Countries

## INDEX

	PAGE
DESCRIPTION OF MACHINES.....	5-9
<b>BUTTONHOLES</b>	
FLAT PURL STITCH BUTTONHOLES.....	15
PYRAMID PURL STITCH BUTTONHOLES.....	15
STRAIGHT BUTTONHOLE WITH RAPID FEED AT EYE END.....	58-60
TO ADJUST MACHINE FOR MAKING STRAIGHT OR EYELET-END BUTTONHOLES.....	25
TO CHANGE STYLE AND LENGTH OF BUTTONHOLE.....	24
TO CHANGE NUMBER OF STITCHES IN BUTTONHOLE.....	26
TO CHANGE THE LENGTH OF EYELET END AND STRAIGHT BUTT- HOLES AND LENGTH OF TAPER BAR.....	25-26
STITCH REGULATING GEARS.....	27
<b>BUTTONHOLE CUTTING MECHANISM.....</b>	<b>46</b>
BUTTONHOLE CUTTING KNIFE.....	46-47
TO REGULATE PRESSURE ON BUTTONHOLE CUTTING KNIFE.....	51
BUTTONHOLE CUTTING BLOCK.....	48-49
TO REFACE BUTTONHOLE CUTTING BLOCK.....	49
PROPER USE OF BUTTONHOLE CUTTING BLOCKS.....	50-51
TO REPLACE THE BUTTONHOLE CUTTING DRIVING LOCK.....	52
<b>CAUTION.....</b>	<b>60-63</b>
<b>CLAMP CARRYING MECHANISM</b>	
TO ADJUST THE CLAMP CARRYING MECHANISM.....	56-58
<b>CORD.....</b>	<b>13</b>
TO THREAD THE CORD.....	18
<b>DIAGRAM SHOWING ORDER OF OPERATION OF MECHANISM.....</b>	<b>19-20</b>
<b>LOOPERS</b>	
TO THREAD THE LOOPER.....	16-17
TO REMOVE AND REPLACE LOOPER FRAME.....	37-38
ALIGNMENT OF THE NEEDLE AND LOOPER FRAME.....	38-39
TO ASSEMBLE LOOPER BRACKET TO MACHINE.....	39-40
TO REPLACE AND TIME THREADED LOOPER.....	34
TO REPLACE AND TIME NON-THREADED LOOPER.....	33-34
TO TIME THE LOOPER DRIVING CRANK.....	41-42
<b>LOOP RETAINERS</b>	
TO REPLACE AND ADJUST RIGHT HAND LOOP RETAINER.....	35-36
TO REPLACE AND ADJUST LEFT HAND LOOP RETAINER.....	36-37

## INDEX — Continued

	PAGE
NEEDLES.....	13
To ADJUST THE NEEDLE GUARD.....	34
To SET THE NEEDLE.....	14
To THREAD THE NEEDLE.....	14-15
NEEDLE VIBRATING MECHANISM.....	31
To ALIGN THE NEEDLE.....	31
To REGULATE THE CUTTING SPACE.....	32
To REGULATE THE WIDTH OF BIGHT.....	33
OILING.....	28-30
OPERATION OF MACHINE.....	20-23
PATTERN WHEEL.....	
To REMOVE AND REPLACE PATTERN WHEEL.....	25
PULLEYS.....	
SHAFT PULLEYS.....	12
RAPID FEED MECHANISM.....	42-44
To REMOVE AND REPLACE CLUTCH ROLLERS.....	44-45
SAFETY LOCK.....	12
SETTING UP MACHINES.....	12
SPEED.....	12
SKIPPING OF STITCHES.....	64
TENSIONS.....	
To ADJUST THE AUTOMATIC NEEDLE THREAD TENSION RELEASER.....	53-54
To REGULATE THE TENSIONS.....	24
To ADJUST THE LOOPER THREAD TENSION RELEASER.....	55
THREAD.....	13
THROAT PLATE.....	
To REPLACE AND ADJUST THE THROAT PLATE.....	37
To PRODUCE FLAT OR PYRAMID PURL STITCH BUTTONHOLES.....	15
WORK CLAMPS.....	
To ADJUST CLAMP CLOSING MECHANISM.....	55
To REGULATE THE AMOUNT OF SPREAD OF WORK CLAMPS.....	53
To REMOVE THE WORK CLAMP PLATES.....	24
ADJUSTMENT OF CLAMP LOCKING MECHANISM.....	58

## DESCRIPTION

99 w 110

### LONG TRAVEL MACHINE

**Machine 99w110** (long travel) has a capacity to sew  $\frac{3}{8}$ " to  $1\frac{1}{2}$ " and cuts straight end buttonholes or eyelet-end buttonholes with large or medium eye, without bar,  $\frac{5}{8}$ " to  $1\frac{9}{16}$ " and with taper bar  $\frac{3}{8}$ " to  $1\frac{1}{2}$ ", the bar being adjustable from  $\frac{1}{8}$ " to  $\frac{3}{8}$ " for  $\frac{5}{8}$ " to  $1\frac{1}{4}$ " buttonholes, from  $\frac{1}{8}$ " to  $\frac{1}{4}$ " for  $1\frac{3}{8}$ " buttonhole and with  $\frac{1}{4}$ " bar for  $1\frac{1}{2}$ " buttonhole. For coats, vests, trousers and clothing generally.

Makes buttonholes with double chain stitch (Singer Buttonhole Stitch), lays a reinforcing cord under the edge of the flat purl and automatically cuts the hole after stitching.

A change in length and shape is made by substituting a quick detachable Pattern Wheel, also Cutting Block and Knife.

Unless otherwise ordered, this machine will be fitted to make a 1 inch eyelet-end buttonhole with large size eye, without bar.

Extra Pattern Wheels, Cutting Blocks and Knives, as listed below and on the following page, can be furnished for use on this variety of machine, for which additional charge will be made.

Equipments for making **eyelet-end buttonholes with medium size eye, without bar:**

Length of Buttonhole	Pattern Wheel No.	Cutting Knife	Cutting Block	Cutting Block Size
$\frac{5}{8}$ " to $\frac{7}{8}$ "	256125	256120	256175	$\frac{5}{8}$ "
			256104	$\frac{3}{4}$ "
			256105	$\frac{7}{8}$ "
$\frac{7}{8}$ " to $1\frac{1}{8}$ "	256127	256120	256106	1"
			256107	$1\frac{1}{8}$ "
$1\frac{1}{8}$ " to $1\frac{3}{8}$ "	256129	256120	256108	$1\frac{1}{4}$ "
			256109	$1\frac{3}{8}$ "
$1\frac{3}{8}$ " to $1\frac{1}{2}$ "	256131	256120	256110	$1\frac{1}{2}$ "
			256111	$1\frac{5}{8}$ "

Equipments for making **eyelet-end buttonholes with large size eye, without bar:**

Length of Buttonhole	Pattern Wheel No.	Cutting Knife	Cutting Block	Cutting Block Size
$\frac{5}{8}$ " to $\frac{7}{8}$ "	256125	256121	256175	$\frac{5}{8}$ "
			256104	$\frac{3}{4}$ "
			256105	$\frac{7}{8}$ "
$\frac{7}{8}$ " to $1\frac{1}{8}$ "	256127	256121	256106	1"
			256107	$1\frac{1}{8}$ "
$1\frac{1}{8}$ " to $1\frac{3}{8}$ "	256129	256121	256108	$1\frac{1}{4}$ "
			256109	$1\frac{3}{8}$ "
$1\frac{3}{8}$ " to $1\frac{1}{2}$ "	256131	256121	256110	$1\frac{1}{2}$ "
			256111	$1\frac{5}{8}$ "

**LONG TRAVEL MACHINE—Continued**

Equipments for making straight buttonholes:

Length of Buttonhole	Pattern Wheel No.	Cutting Knife	Cutting Block	Cutting Block Size
† $\frac{5}{8}$ " to $\frac{7}{8}$ "	256133	256122	256112	$\frac{5}{8}$ "
			256113	$\frac{3}{4}$ "
			256176	$\frac{7}{8}$ "
† $\frac{7}{8}$ " to $1\frac{1}{8}$ "	256135	256122	256114	1"
			256115	$1\frac{1}{8}$ "
† $1\frac{1}{8}$ " to $1\frac{3}{8}$ "	256137	256122	256116	$1\frac{1}{4}$ "
			256117	$1\frac{3}{8}$ "
† $1\frac{3}{8}$ " to $1\frac{5}{8}$ "	256139	256122	256118	$1\frac{1}{2}$ "
			256119	$1\frac{5}{8}$ "

Equipments for making eyelet-end buttonholes with medium size eye, with adjustable taper bar:

Length of Buttonhole	Length of Bar	Pattern Wheel No.	Cutting Knife	Cutting Block
$\frac{5}{8}$ "	$\frac{1}{8}$ " to $\frac{3}{8}$ "	256141	256120	256175
$\frac{3}{4}$ "	$\frac{1}{8}$ " to $\frac{3}{8}$ "	256143	256120	256104
$\frac{7}{8}$ "	$\frac{1}{8}$ " to $\frac{3}{8}$ "	256145	256120	256105
1"	$\frac{1}{8}$ " to $\frac{3}{8}$ "	256147	256120	256106
$1\frac{1}{8}$ "	$\frac{1}{8}$ " to $\frac{3}{8}$ "	256149	256120	256107
$1\frac{1}{4}$ "	$\frac{1}{8}$ " to $\frac{3}{8}$ "	256151	256120	256108
$1\frac{3}{8}$ "	$\frac{1}{8}$ " to $\frac{1}{4}$ "	256153	256120	256109
$1\frac{1}{2}$ "	$\frac{1}{8}$ "	256155	256120	256110

Equipments for making eyelet-end buttonholes with large size eye, with adjustable taper bar:

Length of Buttonhole	Length of Bar	Pattern Wheel No.	Cutting Knife	Cutting Block
$\frac{5}{8}$ "	$\frac{1}{8}$ " to $\frac{3}{8}$ "	256157	256121	256175
$\frac{3}{4}$ "	$\frac{1}{8}$ " to $\frac{3}{8}$ "	256159	256121	256104
$\frac{7}{8}$ "	$\frac{1}{8}$ " to $\frac{3}{8}$ "	256161	256121	256105
1"	$\frac{1}{8}$ " to $\frac{3}{8}$ "	256163	256121	256106
$1\frac{1}{8}$ "	$\frac{1}{8}$ " to $\frac{3}{8}$ "	256165	256121	256107
$1\frac{1}{4}$ "	$\frac{1}{8}$ " to $\frac{3}{8}$ "	256167	256121	256108
$1\frac{3}{8}$ "	$\frac{1}{8}$ " to $\frac{1}{4}$ "	256169	256121	256109
$1\frac{1}{2}$ "	$\frac{1}{8}$ "	256171	256121	256110

Note: Straight buttonholes with taper bar can be made with pattern wheels Nos. 256157 to and including 256171 by removing disengaging block 253444 and changing cutting block and knife.

When preferred, the eyelet-end buttonholes produced on Machines 99w110 to 99w112 can have a square bar made on Machine 68-38 as instructed in Form 8985.

†See page 60.

**MEDIUM TRAVEL MACHINE**

Machine 99w111 (medium travel) has a capacity to sew  $\frac{3}{4}$ " to  $1\frac{1}{8}$ " and cuts straight end buttonholes or eyelet-end buttonholes with large or medium eye, without bar  $\frac{5}{8}$ " to  $1\frac{1}{16}$ " and with taper bar  $\frac{3}{4}$ " to 1", the bar being adjustable from  $\frac{1}{8}$ " to  $\frac{3}{8}$ " for  $\frac{5}{8}$ " to  $\frac{3}{4}$ " buttonholes, from  $\frac{1}{8}$ " to  $\frac{1}{4}$ " for  $\frac{7}{8}$ " buttonhole and with  $\frac{1}{8}$ " bar for 1" buttonhole. For coats, vests, trousers, work clothes, etc.

Makes buttonholes with double chain stitch (Singer Buttonhole Stitch), lays a reinforcing cord under the edge of the flat purl and automatically cuts the hole after stitching.

A change in length and shape is made by substituting a quick detachable Pattern Wheel, also Cutting Block and Knife.

Unless otherwise ordered, fittings on this machine will make without bar 1 inch eyelet-end buttonhole with large size eye and  $\frac{5}{8}$  inch straight buttonhole with stitching suspended at eye end.

Extra Pattern Wheels, Cutting Blocks and Knives, as listed below and on the following page, can be furnished for use on this variety of machine, for which additional charge will be made.

Equipments for making eyelet-end buttonholes with medium size eye, without bar:

Length of Buttonhole	Pattern Wheel No.	Cutting Knife	Cutting Block	Cutting Block Size
$\frac{5}{8}$ " to $\frac{7}{8}$ "	256535	255345	255334	$\frac{5}{8}$ "
			255335	$\frac{3}{4}$ "
			255336	$\frac{7}{8}$ "
$\frac{7}{8}$ " to $1\frac{1}{8}$ "	256537	255345	255337	1"
			255338	$1\frac{1}{8}$ "

Equipments for making eyelet-end buttonholes with large size eye, without bar:

Length of Buttonhole	Pattern Wheel No.	Cutting Knife	Cutting Block	Cutting Block Size
$\frac{5}{8}$ " to $\frac{7}{8}$ "	256535	255347	255334	$\frac{5}{8}$ "
			255335	$\frac{3}{4}$ "
			255336	$\frac{7}{8}$ "
$\frac{7}{8}$ " to $1\frac{1}{8}$ "	256537	255347	255337	1"
			255338	$1\frac{1}{8}$ "
* 1"	256530	255347	255337	1"

\*See next page.

## EXTRA LONG TRAVEL MACHINE

Machine 99w112 (extra long travel) has a capacity to sew  $\frac{3}{4}$ " to 2" and cuts straight end buttonholes or eyelet end buttonholes with large or medium eye without bar  $\frac{3}{4}$ " to  $1\frac{1}{4}$ " and cuts straight end buttonholes or eyelet-end buttonholes with large or medium eye with taper bar  $\frac{3}{4}$ " to  $1\frac{1}{4}$ ", the bar being adjustable from  $\frac{1}{4}$ " to  $\frac{3}{4}$ " for  $\frac{3}{4}$ " to  $1\frac{1}{4}$ " buttonholes and from  $\frac{1}{4}$ " to  $\frac{1}{2}$ " for  $1\frac{1}{4}$ " buttonhole. For overcoats, sack coats and clothing generally.

Makes buttonholes with double chain stitch (Singer Buttonhole Stitch), lays a reinforcing cord under the edge of the flat purl and automatically cuts the hole after stitching.

A change in length and shape is made by substituting a quick detachable Pattern Wheel, also Cutting Block and Knife.

Unless otherwise ordered, this machine will be fitted to make a 2 inch eyelet-end buttonhole, with medium size eye, without bar.

Extra Pattern Wheels, Cutting Blocks and Knives, as listed below and on the following page, can be furnished for use on this variety of machine, for which additional charge will be made.

Equipments for making eyelet-end buttonholes with medium size eye, without bar:

Length of Buttonhole	Pattern Wheel No.	Cutting Knife	Cutting Block	Cutting Block Size
$\frac{3}{4}$ " to 1"	256829	252337	253159	$\frac{3}{4}$ "
			253160	$\frac{7}{8}$ "
			253161	1"
1" to $1\frac{1}{4}$ "	256831	252337	253162	$1\frac{1}{8}$ "
			253163	$1\frac{1}{4}$ "
$1\frac{1}{4}$ " to $1\frac{1}{2}$ "	256833	252337	253164	$1\frac{3}{8}$ "
			253165	$1\frac{1}{2}$ "
$1\frac{1}{2}$ " to $1\frac{3}{4}$ "	256835	252337	253166	$1\frac{5}{8}$ "
			253167	$1\frac{3}{4}$ "
$1\frac{3}{4}$ " to 2"	256837	252337	253168	$1\frac{7}{8}$ "
			253169	2"

Equipments for making eyelet-end buttonholes with large size eye, without bar:

Length of Buttonhole	Pattern Wheel No.	Cutting Knife	Cutting Block	Cutting Block Size
$\frac{3}{4}$ " to 1"	256839	252338	253159	$\frac{3}{4}$ "
			253160	$\frac{7}{8}$ "
			253161	1"
1" to $1\frac{1}{4}$ "	256841	252338	253162	$1\frac{1}{8}$ "
			253163	$1\frac{1}{4}$ "
$1\frac{1}{4}$ " to $1\frac{1}{2}$ "	256843	252338	253164	$1\frac{3}{8}$ "
			253165	$1\frac{1}{2}$ "
$1\frac{1}{2}$ " to $1\frac{3}{4}$ "	256845	252338	253166	$1\frac{5}{8}$ "
			253167	$1\frac{3}{4}$ "
$1\frac{3}{4}$ " to 2"	256847	252338	253168	$1\frac{7}{8}$ "
			253169	2"

## MEDIUM TRAVEL MACHINE—Continued

Equipments for making straight buttonholes:

Length of Buttonhole	Pattern Wheel No.	Cutting Knife	Cutting Block	Cutting Block Size
† $\frac{5}{8}$ " to $\frac{3}{4}$ "	256507	255344	255339	$\frac{5}{8}$ "
			255340	$\frac{3}{4}$ "
			255341	$\frac{7}{8}$ "
† $\frac{5}{8}$ " to $1\frac{1}{4}$ "	256509	255344	255342	1"
			255343	$1\frac{1}{8}$ "
* 1"	256530	255344	255342	1"
* $\frac{7}{8}$ "	256530	255347	256528	$\frac{7}{8}$ "

Equipments for making straight buttonholes with or without rapid feed at eye end or eyelet-end with large size eye as desired.

Style of Buttonhole	Length of Buttonhole	Pattern Wheel No.	Cutting Knife	Cutting Block
* Straight	$\frac{7}{8}$ "	256530	255347	256528
* Straight	1"	256530	255344	255342
* Eye	1"	256530	255347	255337

\*See page 59. This size and style of buttonhole is made with combination pattern wheel. The cutting block and knife must be changed for the particular style of buttonhole stitched. †See page 60.

Equipments for making eyelet-end buttonholes with medium size eye, with adjustable taper bar:

Length of Buttonhole	Length of Bar	Pattern Wheel No.	Cutting Knife	Cutting Block
$\frac{5}{8}$ "	$\frac{1}{8}$ " to $\frac{3}{8}$ "	256539	255345	255334
$\frac{3}{4}$ "	$\frac{1}{8}$ " to $\frac{3}{8}$ "	256541	255345	255335
$\frac{7}{8}$ "	$\frac{1}{8}$ " to $\frac{1}{4}$ "	256543	255345	255336
1"	$\frac{1}{8}$ "	256545	255345	255337

Equipments for making eyelet-end buttonholes with large size eye, with adjustable taper bar:

Length of Buttonhole	Length of Bar	Pattern Wheel No.	Cutting Knife	Cutting Block
$\frac{5}{8}$ "	$\frac{1}{8}$ " to $\frac{3}{8}$ "	256519	255347	255334
$\frac{3}{4}$ "	$\frac{1}{8}$ " to $\frac{3}{8}$ "	256521	255347	255335
$\frac{7}{8}$ "	$\frac{1}{8}$ " to $\frac{1}{4}$ "	256523	255347	255336
1"	$\frac{1}{8}$ "	256525	255347	255337

Note: Straight buttonholes with taper bar can be made with pattern wheels Nos. 256519 to and including 256525 by removing disengaging block 253444 and changing cutting block and knife.

## EXTRA LONG TRAVEL MACHINE—Continued

Equipments for making straight buttonholes:

Length of Buttonhole	Pattern Wheel No.	Cutting Knife	Cutting Block	Cutting Block Size
¾" to 1"	256829 or 256839	252339	253170	¾"
			253171	⅞"
			253172	1"
1" to 1¼"	256831 or 256841	252339	253173	1⅛"
			253174	1¼"
1¼" to 1½"	256833 or 256843	252339	253175	1⅜"
			253176	1½"
1½" to 1¾"	256835 or 256845	252339	253177	1⅝"
			253178	1¾"
1¾" to 2"	256837 or 256847	252339	253179	1⅞"
			253180	2"

Equipments for making eyelet-end buttonholes with medium size eye, with adjustable taper bar:

Length of Buttonhole	Length of Bar	Pattern Wheel No.	Cutting Knife	Cutting Block
¾"	¾" to ¾"	252216	252337	253159
⅞"	¾" to ¾"	252218	252337	253160
1"	¾" to ¾"	252220	252337	253161
1⅛"	¾" to ¾"	252222	252337	253162
1¼"	¾" to ¾"	252224	252337	253163
1⅜"	¾" to ¾"	252226	252337	253164
1½"	¾" to ¾"	252228	252337	253165
1¾"	¾" to ¾"	252232	252337	253167

Equipments for making eyelet-end buttonholes with large size eye, with adjustable taper bar:

Length of Buttonhole	Length of Bar	Pattern Wheel No.	Cutting Knife	Cutting Block
¾"	¾" to ¾"	256807	252338	253159
⅞"	¾" to ¾"	256809	252338	253160
1"	¾" to ¾"	256811	252338	253161
1⅛"	¾" to ¾"	256813	252338	253162
1¼"	¾" to ¾"	256815	252338	253163
1⅜"	¾" to ¾"	256817	252338	253164
1½"	¾" to ¾"	256819	252338	253165
1¾"	¾" to ¾"	256821	252338	253167

## Lapel or Straight Buttonhole Machine

Machine 99w113 (Medium Travel) has a capacity to sew ⅝" to 1½" and cut straight end buttonholes without bar ⅝" to 1⅛" and with taper bar ⅝" to 1", the bar being adjustable from ⅛" to ⅜" for ⅝" and ¾" buttonholes, from ⅛" to ¼" for ⅞" buttonhole and with ⅛" bar for 1" buttonhole, for lapel buttonholes in clothing.

Makes buttonholes with double chain stitch (Singer Buttonhole Stitch), lays a reinforcing cord under the edge of the flat purl and automatically cuts the hole after stitching.

A change in length and shape is made by substituting a quick detachable Pattern Wheel and Cutting Block.

Unless otherwise ordered, fittings on this machine will make ⅞" straight stitched end buttonhole without bar.

Extra pattern Wheels and Cutting Blocks, as listed below, can be furnished for use on this machine, for which additional charge will be made.

Equipments for making straight stitched end buttonholes, without bar:

LENGTH OF BUTTONHOLE	PATTERN WHEEL NO.	CUTTING KNIFE	CUTTING BLOCK	CUTTING BLOCK SIZE
⅝" to ⅞"	256507	255344	255339	⅝"
			255340	¾"
			255341	⅞"
⅞" to 1⅛"	256509	255344	255342	1"
			255343	1⅛"

Equipment for making straight stitched end buttonholes, with the adjustable taper bar:

LENGTH OF BUTTONHOLE	LENGTH OF BAR	PATTERN WHEEL NO.	CUTTING KNIFE	CUTTING BLOCK
⅝"	⅛" to ⅜"	256519	255344	255339
			256521	255340
¾"	⅛" to ⅜"	256523	255344	255341
			256525	255344
⅞"	⅛" to ¼"	256525	255344	255344
1"	⅛"			

### To Set Up the Machines

See Form 1875w, instructions for setting up machines on power tables with driving equipments.

#### Speed

The maximum speeds recommended for the shafts in Machines 99w110 to 99w113 are as follows:

**Buttonhole Cutting Shaft**—185 to 200 revolutions per minute.

**Stop Motion Shaft**—750 to 800 revolutions per minute. (This will drive the arm shaft at a speed of from 1500 to 1600 revolutions per minute.)

The table shaft pulley sent out with the machine for driving the sewing mechanism and buttonhole cutting mechanism is made in various sizes, as listed below, for different speeds of table shafts. Care **must** therefore be taken to see that the table shaft pulley used is of the correct size to drive the stop motion shaft (Fig. 10) at a speed of 750 to 800 revolutions per minute and the buttonhole cutting shaft (K4, Fig. 8) at a speed of 185 to 200 revolutions per minute. The correct speed of the stop motion shaft should be ascertained by placing a speed indicator at the gear end of the rapid feed crank shaft. The speed of the rapid feed crank shaft should be about 1250 to 1325 revolutions per minute. See Fig. 10.

#### Shaft Pulleys

Speed of Shaft	Shaft Pulley	Diameter of Pulley	Speed of Shaft	Shaft Pulley	Diameter of Pulley
250	27075	15 in.	500	27067	7 in.
265	27074	14 in.	550	232880	6½ in.
300	27072	12 in.	600	27066	6 in.
350	27070	10 in.	660	232879	5½ in.
400	27069	9 in.	730	27065	5 in.
425	232882	8½ in.	800	232920	4½ in.
465	150611	8 in.	900	27271	4 in.

#### Safety Lock

To prevent accidental starting of the machine when threading, oiling or making adjustments, the machine can be locked out of operation by pushing the safety lock (T4, Fig. 8) back under the starting rod block (S4, Fig. 8), thus holding up the starting rod so that it cannot be depressed to start the machine. When finished threading, oiling or making adjustments, it will be necessary to unlock the machine by swinging the safety lock forward from under the starting rod block, before the machine can be started in operation.

### Needles

Needles for Machines 99w110 to 99w113 are of the following Class and Variety Nos.:

Class and Variety	Description	Style of Point	Sizes
142 x 1	for Cloth	Round	13, 14, 15, 16, 17, 18, 19
142 x 5	for Cloth	Round	10, 12, 13, 14, 15, 16, 17, 18, 19, 21
142 x 6	for Khaki	Spear Wedge	17, 19
142 x 8	for Leather	Reverse Spear	17, 18, 19

The size of the needle to be used should be determined by the size of the thread which must pass freely through the eye of the needle. If rough or uneven thread is used, or if it passes with difficulty through the eye of the needle, the successful use of the machine will be interfered with.

Orders for needles must specify the **quantity** required, the **size**, also the **class** and **variety** numbers separated by the letter x.

The following is an example of an intelligible order:

"100 No. 17, 142x1 Needles," if for Cloth.

"100 No. 17, 142x5 Needles," if for Cloth.

"100 No. 17, 142x6 Needles," if for Khaki.

"100 No. 17, 142x8 Needles," if for Leather.

The best stitching results will be obtained in using the needles sold by Singer Sewing Machine Company.

#### Thread and Cord

Either right or left twist thread may be used in the needle and looper.

When stitching buttonholes with silk thread, a heavier thread should be used in the looper than in the needle, for example: use B silk in the looper with A silk in the needle.

When stitching buttonholes with cotton thread, regular buttonhole thread is recommended. Harder finish thread should always be used in the looper than in the needle. This will facilitate the formation of perfect stitches in the buttonhole.

For the cord, medium size buttonhole cord will give the best results.



### To Set the Needle

Loosen the set screw (Q7, Fig. 13) in the needle clamp and put the needle up into the clamp as far as it will go with its long groove to the rear and its eye parallel or in line with the bed of the machine, then firmly tighten the set screw (Q7).

### To Thread the Needle

Pass the thread from the unwinder down through the hole (1, Fig. 2) in the upper end of the needle thread leader, through the hole (2, Fig. 2) in the lower end of the needle thread leader, from back to front under between the tension discs (3, Fig. 2),

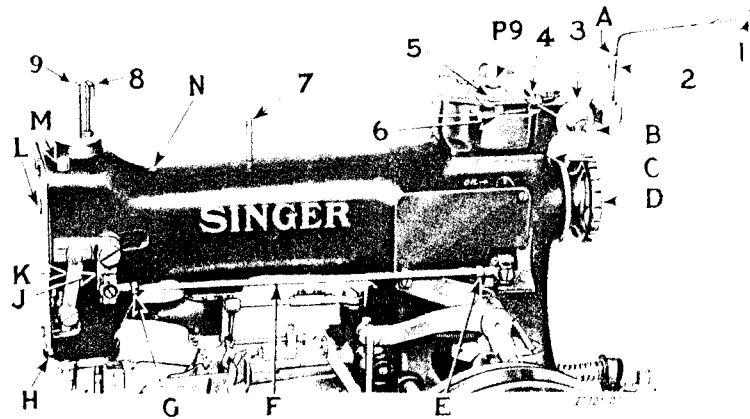

Fig. 2. Threading the Needle

up through the slotted hole in the take-up thread guide (4, Fig. 2), down through the forward hole (5, Fig. 2), down through the hole in the end of the thread take-up (6, Fig. 2), through the hole (7, Fig. 2) in the top of the needle thread guide pin, under the needle thread pull-off (adjustable) (8, Fig. 2) and down through the hollow needle bar (9, Fig. 2) (inserting the threading wire furnished with the machine up into the needle bar from below to pull the thread through), pass the thread from back to front or toward you through the eye of the needle, as shown in Fig. 6.

**Note:** When it is necessary to place the thread unwinder at the side of the machine, the needle thread leader (1, Fig. 2) at the top of the machine should be turned in the direction of the unwinder and the thread should be passed through the hole (A, Fig. 2) instead of the hole (2, Fig. 2).

### To Produce Flat Purl Stitch Buttonholes

When it is desired to make flat purl stitch buttonholes on Machines 99w110 to 99w113, throat plate 254093 must be used. This throat plate delivers the cord in a position farthest away from the slit of the buttonhole. Care should be taken to see that the top of the throat plate is set about flush with the upper surface of the work clamp plates, also see that the thread retainers clear the under side of the throat plate and that the needle does not strike the throat plate.

### To Produce Pyramid Purl Stitch Buttonholes

When it is desired to make pyramid purl stitch buttonholes on Machines 99w110 to 99w113, throat plate 256082 must be used. Care should be taken to see that the top of the throat plate is set about flush with the upper surface of the work clamp plates. Also see that the needle vibrates evenly on both sides of the cord without coming into contact with the throat plate, and that the thread retainers clear the under side of throat plate.

When changing from flat purl stitch to pyramid purl stitch buttonholes, set the machine for the narrowest bight as instructed on page 33.

When changing from pyramid purl stitch to flat purl stitch buttonholes, it will be necessary to increase the width of bight as instructed on page 33, until the desired effect is obtained.

In either of the above cases, it may also be necessary to slightly change the tension on the needle thread and the looper thread, as instructed on page 24, to produce perfect stitching.

### To Thread the Looper

Unhook the two springs (K3 and Z3, Fig. 6) and swing out the two work clamp plates (O3 and W3, Fig. 6), then press in the buttons (S3 and U3, Fig. 6) and at the same time draw the bed end cover (T3, Fig. 6) toward you to remove it from the machine.

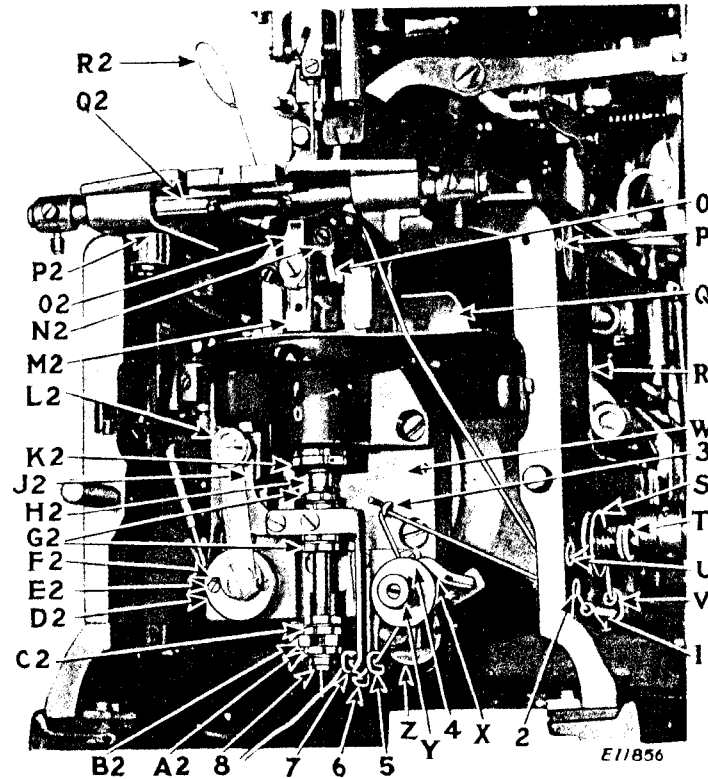

Fig. 3. Threading the Looper  
Also Showing Threading the Cord

Pass the thread from the unwinder through the lower brass tube (1, Figs. 3 and 10) which is attached to the right side of the bed of the machine (using the threading wire furnished for the purpose), then through the lower hole (2, Fig. 3) in the bed of the

machine at the front of the brass tube, through the wire thread eyelet (3, Fig. 3), down, under and from right to left between the

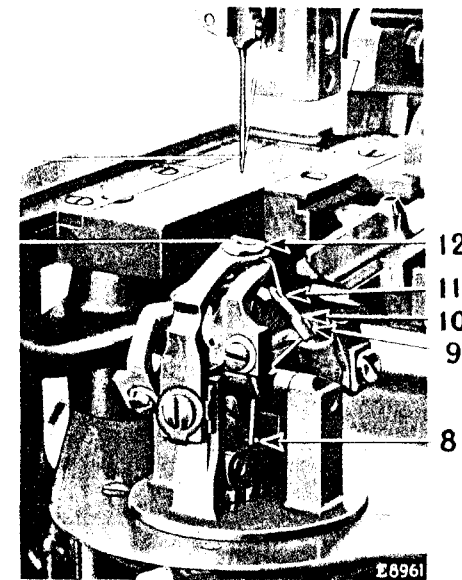

Fig. 4. Threading the Looper

tension discs (4, Fig. 3), from right to left through the right hand self-threading guide slot (5, Fig. 3) in the thread controller bracket, through the slot in the thread controller (6, Fig. 3) and through the left hand self-threading guide slot (7, Fig. 3) in the thread controller bracket. Pass the threading wire (R2, Fig. 3) between the throat plate (O2, Fig. 3) and right hand loop retainer (N2, Fig. 3) down through the hollow loop retainer driving bar (8, Figs. 3 and 4). Hook the thread on the end of the wire and draw it up through the hollow bar (8) up through the slot (9, Fig. 4) in the heel of the looper, as illustrated in Fig. 4, down through the centre hole (10, Fig. 4) in the looper and up through the hole (11, Fig. 4) in the point of the looper, then up through the large needle hole (12, Fig. 4) in the throat plate.

### To Thread the Cord

The work clamp plates having been swung outward and the bed end cover removed, pass the cord from the unwinder through the upper brass tube (V, Figs. 3 and 10) which is attached to the right side of the bed of the machine (using the threading wire furnished for the purpose), then pass the cord over and between the tension discs (S, Fig. 3) adjacent to the cord tube, through the hole (U, Fig. 3) in the right hand side of the bed of the machine, up through the hole (G3, Fig. 5) in the cord guide leader under the spring tension (F3, Fig. 5), thence from back to front through the cord hole (H3, Fig. 5) near the centre of the throat plate, the cord leading toward the operator as shown in Fig. 5. Then swing the work clamp plates back into place and

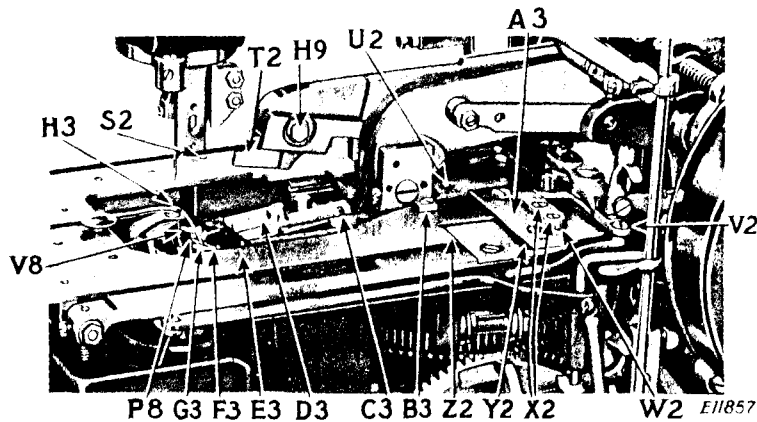

Fig. 5. Threading the Cord

hook the springs (K3 and Z3, Fig. 6) to hold the plates in position. Also replace the bed end cover, then clamp the ends of the cord and looper thread in the thread clamps (P3 and R3, Fig. 6).

When a hard finish or stiff cord is used, the cord should pass through the hole (P, Fig. 3) in the upper right hand side of the bed instead of the lower hole (U, Fig. 3).

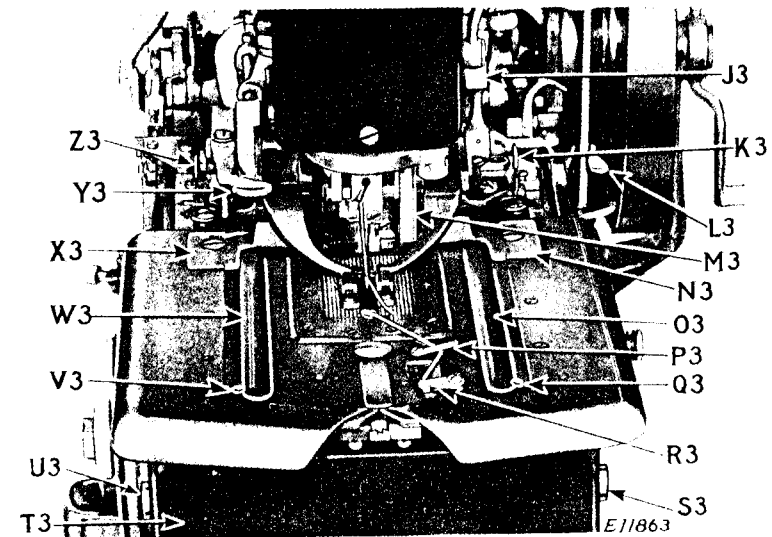

Fig. 6. Threading of Machine Completed

Diagram showing order of operation of mechanism in Machines 99w110 to 99w113 during the stitching and cutting of a buttonhole from start to finish.

- A—Work Clamps are closed by Clamp Closing Lever
- B—Buttonhole is spread by Clamp Closing Lever
- C—Rapid Feed is started by Clamp Closing Lever
- D—Sewing is started by Pattern Wheel Ring
- E—Rapid Feed is stopped by Pattern Wheel
- X—Buttonhole is stitched (indicated by solid line)
- F—Sewing is stopped by Pattern Wheel Ring
- G—Rapid Feed is started by Stop Motion
- H—Buttonhole Cutter is tripped by Tripping Point on Side of Pattern Wheel Shaft Gear
- I—Buttonhole is cut by Buttonhole Cutting Shaft
- J—Work Clamps are opened and spread is released by Cam on Buttonhole Cutting Shaft
- K—Rapid Feed is stopped by Pattern Wheel
- L—Starting and stopping point

Dotted line represents rapid feed.

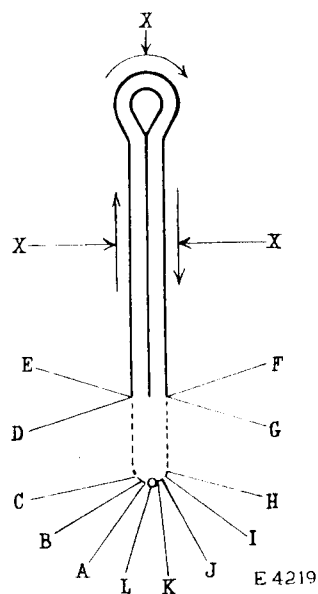

Fig. 7

### Operation of the Machine

The operator should sit a little to the left of the centre of the front of the machine so that the opening in the work clamps can be fully seen. This position will be found to be the most convenient for the operator for the reason that the work is moved from left to right in the machine when passing from one buttonhole to another, and also because the finger starting lever is located above the left work clamp plate.

Unlock the machine by swinging the safety lock (T4, Fig. 8) toward you. Place the work in position in the machine so that the portion in which it is desired to make the buttonhole is directly under the opening in the work clamps. Then set the two work position gauges (N3 and X3, Fig. 6) against the edge of the work and fasten them in position. Hold the work firmly in position with the hands and at the same time press down on the finger starting lever (Y3, Fig. 6). This will trip the lever (C4, Fig. 8) from engagement with the locking head on rear of clamp closing stud (F4, Fig. 8). The stud will then be held out of engagement with the cam path in the pulley (J4, Fig. 8) by lug on latch (D4, Fig. 8) until the cam path is in the correct position to receive the stud, at which time the tripping cam block on the inside face of pulley (J4) will trip the lever (E4, Fig. 8), lifting the latch (D4) and allowing the

stud (F4) to engage the cam path in pulley (J4), causing the clamp closing lever (D5, Fig. 8) to be depressed and the work

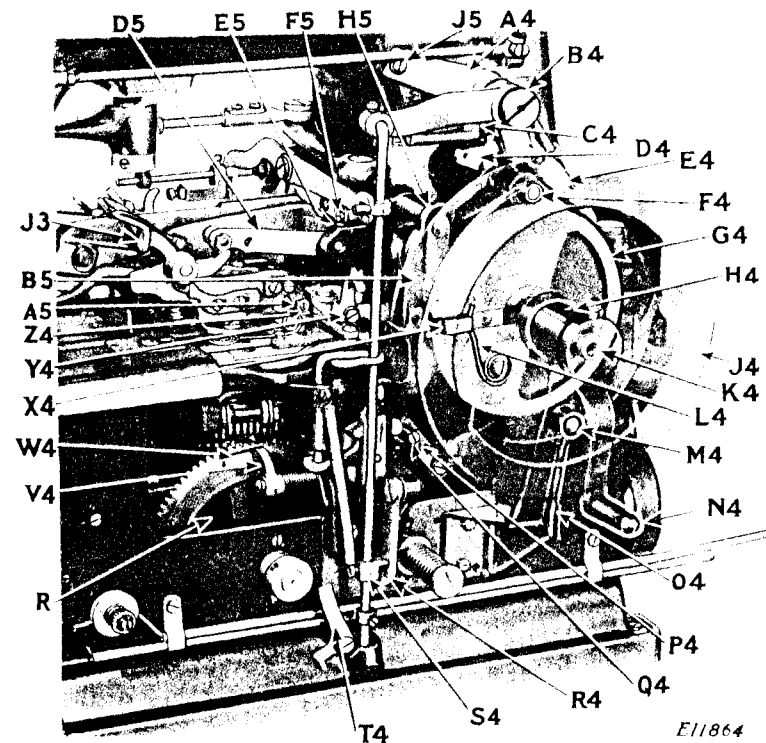

Fig. 8. "X-Ray" View of Buttonhole Cutter Pulley Showing Buttonhole Cutter Engaging Stud and Latch

clamps to be lowered upon the work. As the latch (Y4, Fig. 8) moves forward it engages the work clamp spreader lever, pushing this lever forward to spread the work clamps, thus stretching the fabric taut under the clamps. The stud (Q4, Fig. 8) then engages the rapid feed starting latch (P4, Fig. 8), causing the rapid feed to move the work clamp plates with the work to a stitching position and the stud (F4, Fig. 8) is forced inwardly, by the stud disengaging cam block mounted in the cam path of the pulley (J4, Fig. 8), under the stud lock plate (A4, Fig. 8) into locking position and held by the lever (C4, Fig. 8) in the locking notch. When the work clamp plates are brought to this position, the rapid feed is disengaged by the tripping point (V5, Fig. 9) on the inner side of the pattern wheel (U5, Fig. 9) coming into contact with the latch (W5, Fig. 9), and the stitching mechanism

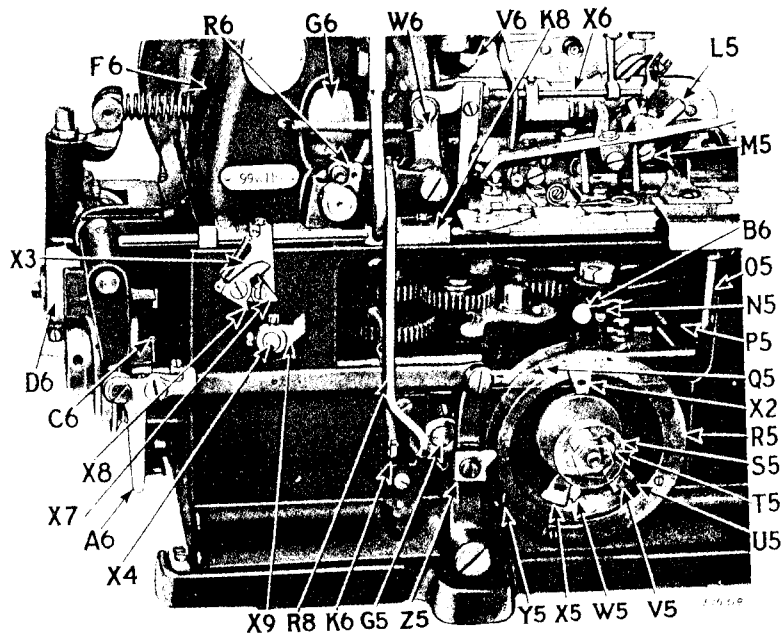
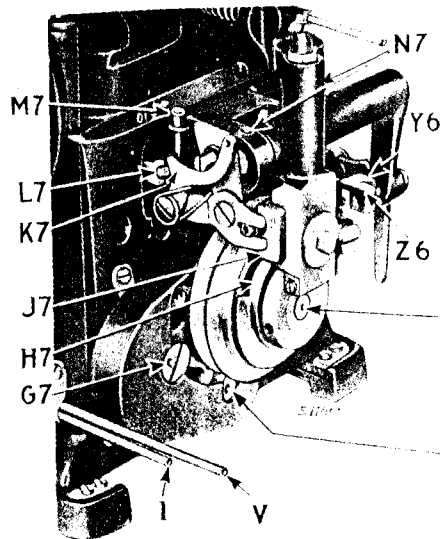

Fig. 9. "X-Ray" View of Pattern Wheel Showing Tripping Points

is started in operation by the action of the stop lever operating plate (Z5, Fig. 9) riding up the incline (Y5, Fig. 9) on the pattern



STOP MOTION  
SHAFT MAXI-  
MUM SPEED 750  
TO 800 R.P.M.

RAPID FEED  
CRANK SHAFT  
MAXIMUM  
SPEED 1250 TO  
1325 R. P. M.

Fig. 10. View of Stop Motion Showing Shaft Speeds

wheel ring, causing the stop lever (D6, Fig. 9) to swing back out of engagement with the stop cam on the sewing pulley. The machine then stitches the buttonhole and at the completion of the stitching, the stop lever operating plate (Z5, Fig. 9) drops off at the square shoulder (Q5, Fig. 9) on the pattern wheel ring, causing the stop lever to swing in, ready to lock in the stop cam on the sewing pulley. As the interlocking slide (J7, Fig. 10) is raised by the action of the stop cam (H7, Fig. 10), the point of the latch (K7, Fig. 10) is lowered fully  $\frac{1}{16}$  inch below the end of the second rapid feed starting lever (L7, Fig. 10). As the interlocking slide (J7, Fig. 10) drops into the notch of the stop cam (H7, Fig. 10), it raises the latch (K7, Fig. 10) which in turn raises the second rapid feed starting lever (L7, Fig. 10) as it comes into contact with it, thereby starting the rapid feeding mechanism in operation to move the clamp plates back to a starting position for the next buttonhole.

At the finish of the rapid feeding of the work clamp plates, the rapid feed is disengaged by the tripping point (X5, Fig. 9) on the inner side of the pattern wheel (U5, Fig. 9) coming into contact with the latch (W5, Fig. 9). At the same time, the tripping point attached to the rim of the pattern wheel shaft gear actuates the buttonhole cutting starting lever (H5, Fig. 8) causing the lock (X4, Fig. 8) in the inner buttonhole cutting wheel to engage the loose buttonhole cutting pulley and at the same time the starting rod lock (R4, Fig. 8) is swung off the top of the starting rod block (S4, Fig. 8) allowing the starting rod to spring up to an operative position. As the inner buttonhole cutting wheel (G4, Fig. 8) is fastened in a rigid position on the buttonhole cutting shaft (K4, Fig. 8), the shaft is rotated when the wheel and loose pulley are locked together by the lock (X4, Fig. 8). When the buttonhole cutting shaft starts to rotate, the buttonhole cutting levers are moved into action by the operating cams on the buttonhole cutting shaft, and the cutting block is carried forward and then down on the knife to cut the buttonhole. The work spreaders are then returned to a starting position and the work clamps are raised by means of the bell crank (W6, Fig. 9) and push rod (X6, Fig. 9) actuated by the cam (R6, Fig. 9) on the left end of the buttonhole cutting shaft, after which the lock (X4, Fig. 8) in the inner buttonhole cutting wheel is withdrawn from the loose buttonhole cutting pulley, releasing the wheel from the pulley and thus stopping the rotation of the buttonhole cutting shaft. The operator then moves the work from left to right for the next buttonhole.

For the convenience of the operator, the lever (J3, Figs. 6 and 8) above the right hand work clamp plate, may be used to lower the work clamps upon the work when desired.

### To Remove the Work Clamp Plates

When it is desired to remove the work clamp plates (O3 and W3, Fig. 6) from the machine, for the purpose of making adjustments, this can be done as follows: Unhook the two springs (K3 and Z3, Fig. 6) on the work clamp plates, then swing each plate outward at right angle to the machine and lift the plates from the machine.

### To Regulate the Tensions

The tension on the needle thread is regulated by the thumb nut (B, Fig. 2) at the right of the tension discs at the top of the machine. To increase the tension, turn this thumb nut over from you. To decrease the tension, turn this thumb nut over toward you. The tension on the needle thread should be sufficiently heavy to set the purl of the buttonhole on the underside of the work.

The tension on the looper thread is regulated by the thumb nut (Y, Fig. 3) at the front of the tension discs inside the front of the bed of the machine. To increase the tension, turn this thumb nut over to the right. To decrease the tension, turn this thumb nut over to the left. The tension on the looper thread should be sufficient to balance the tension of the needle thread and give the desired character to the formation of the stitch.

The tension on the cord is regulated by the thumb nut (T, Fig. 3). To increase the tension, turn this thumb nut over from you. To decrease the tension, turn this thumb nut over toward you. The tension on the cord should be light.

### To Change the Style and Length of Buttonhole

When it is desired to make a different style and length of buttonhole it will be necessary to change the pattern wheel (U5, Fig. 9), buttonhole cutting block (T2, Fig. 5) and the cutting knife (D3, Fig. 5). Some pattern wheels produce two styles of buttonholes as shown in the lists on pages 5 to 10 inclusive, in which cases the following adjustment is necessary to change from one style of buttonhole to the other.

**To Adjust Machines 99w110 and 99w111 for making Eyelet-end Buttonholes (with large size eye) without a Bar.** Having placed the desired pattern wheel in the machine, see that the locking pin (B6, Fig. 9) rests on the straight ledge of the work clamp side throw lever as shown in Fig. 9, then place the correct buttonhole cutting block and knife in the machine. (See list of cutting blocks and knives given on pages 5 to 8 inclusive.)

**To Adjust Machines 99w110 and 99w111 for making Eyelet-end Buttonholes (with medium size eye) with a Taper Bar or without a Bar, also Straight Buttonholes.** Having placed the desired pattern wheel in the machine, see that the locking pin (B6, Fig. 9) rests in the vertical slot (N5, Fig. 9) of the work

clamp side throw lever, then place the correct buttonhole cutting block and knife in the machine. (See list of cutting blocks and knives given on pages 5 to 8 inclusive.)

**To Remove the Pattern Wheel,** draw the lever (A6, Fig. 9) toward you so as to swing the stop lever operating plate (Z5, Fig. 9) back out of range of the pattern wheel. Raise the locking pin (B6, Fig. 9) out of the vertical slot (N5, Fig. 9) and swing it backward so that it rests on the straight ledge, then remove the nut (S5, Fig. 9) and withdraw the pattern wheel.

**To Replace the Pattern Wheel,** push it on the shaft as far as it will go, having the position stud (T5, Fig. 9) enter the small hole in the pattern wheel, then fasten it firmly in position with the nut (S5, Fig. 9).

**To Adjust Machine 99w112 for making Eyelet-end Buttonholes with a Taper Bar or without a Bar.** Having placed the desired pattern wheel in the machine, see that the locking pin (B6, Fig. 9) rests in the vertical slot (N5, Fig. 9) of the work clamp side throw lever, then place the correct buttonhole cutting block and knife in the machine. (See list of cutting blocks and knives given on pages 9 and 10).

**To Adjust Machine 99w112 for making Straight Buttonholes.** Having placed the desired pattern wheel in the machine, see that the locking pin (B6, Fig. 9) rests on the straight ledge of the work clamp side throw lever, as shown in Fig. 9, then place the correct buttonhole cutting block and knife in the machine. (See list of cutting blocks and knives given on pages 9 and 10).

### To Change the Length of Eyelet-end and Straight Buttonholes and Length of Taper Bar

Different lengths of sewing for eyelet-end or straight buttonholes and different lengths of bars for taper bar buttonholes can be produced with pattern wheels, as listed on pages 5 to 10, by adjustments as follows:

Remove the pattern wheel from the machine and take out the two screws which fasten the two pattern wheel segments to the pattern wheel. It will be noticed that there are several radial lines on the pattern wheel which are used as a guide for setting the segments in the required position. To make the longest bar, move the two segments outwardly until their ends register with the lines which are farthest from the elongated screw hole in the pattern wheel ring. To make the shortest bar, move the segments inwardly until their ends register with the lines which are nearest to the elongated screw hole in the pattern wheel ring. For intermediate lengths of bars, adjust the segments to the corresponding intermediate lines. When the segments are set in the desired position, securely tighten their fastening screws.

When the segments are set to make the longest bar, the rapid feed stopping tripping point, which is nearest to the dogging hole on the inside of the pattern wheel, must be set in the screw hole nearest to the other tripping point, and for the shortest bar, it must be set in the screw hole farthest from the other tripping point. For intermediate lengths of bars, use the intermediate screw holes. This tripping point must always be so adjusted that it trips the rapid feed stop just as the sewing starting segment has actuated the stitching mechanism. If it is set too early, the machine will stop because the rapid feed will cease before the sewing feed begins. If it is set too late, the space between the first two or three stitches will be too great because the rapid feed, which is faster than the sewing feed, will continue after the sewing has commenced.

#### To Change the Number of Stitches in the Buttonhole

The number of stitches in the buttonhole is controlled by the stitch regulating gear (Y7, Fig. 11) in the left side of the machine.

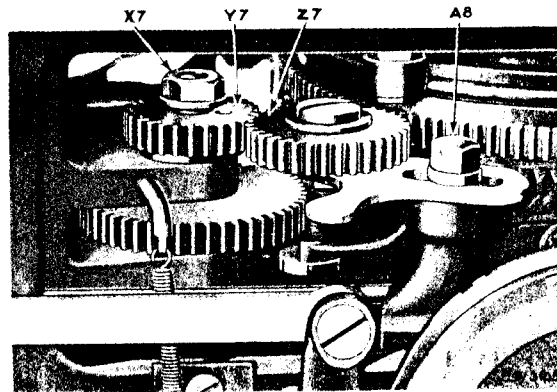

Fig. 11. Changing Stitch Regulating Gear

When it is desired to change the number of stitches in the buttonhole it will only be necessary to change the stitch regulating gear. To remove this gear, loosen the screw (A8, Fig. 11) in the slotted lever and pull the lever toward you, then remove the nut (X7, Fig. 11) which is above the stitch regulating gear (Y7, Fig. 11) and lift off the gear with the stitch regulating gear holder. The stitch regulating gears are listed on the following page.

### Stitch Regulating Gears

#### Machine 99w110

Gear No.	Feed Wheel	Stitches per Inch	Stitches in Eye
250210	256099	36	17
250211	256099	31	14
250212	256099	28	13
250598	256099	26	12
250213	256099	24	11
250214	256099	23	11
250415	256099	21	10
250478	256099	19	9

#### Machine 99w111

250210	256501	33	15
250211	256501	28	13
250212	256501	26	12
250598	256501	24	11
250213	256501	22	10
250214	256501	21	10
250415	256501	19	9
250478	256501	17	8

#### Machine 99w112

250210	252076	42	18
250211	252076	36	15
250212	252076	33	14
250598	252076	31	13
250213	252076	28	12
250214	252076	27	12
250415	252076	24	11
250478	252076	22	10

#### Machine 99w113

250210	256550	36	7
250211	256550	33	6
250212	256550	30	6
250598	256550	28	5
250213	256550	26	5
250214	256550	25	4
250415	256550	22	4
250478	256550	20	4

The sum of the outside or counting stitches on each side of the buttonhole plus the stitches in eye (as shown in table) is the total number for the buttonhole. With the length of the buttonhole being understood as the length from the inside edge of the purl at eye end to the end of sewing, the total number of stitches

for any length of buttonhole may be readily computed: Subtract  $\frac{1}{16}$  inch from length of buttonhole to be computed, multiply result by 2 and then multiply this product by stitches per inch in table given for gear being used. To this, add eye stitches designated in the table for same gear, the result will be number of counting stitches in buttonhole.

Speed indicator readings taken from arm shaft will indicate the number of dips of needle which is twice the total of outside dips of the needle or counting stitches.

Having selected the gear desired, place it in position and firmly fasten it with nut (X7, Fig. 11). Then advance the pattern wheel shaft by means of wrench a slight amount and at the same time push on the end of feed adjusting gear bracket until the adjusting gear (Z7, Fig. 11) drops into mesh with the stitch regulating gear. After the gears have been correctly set, tighten the screw (A8, Fig. 11). When turning the pattern wheel shaft with the wrench, care should be taken that it is turned only sufficiently far to mesh the first tooth, thus avoiding moving the machine out of cutting position.

### To Oil the Machine

To ensure easy running and prevent unnecessary wear to the machine, oil should be regularly applied at least once each day to all oil holes and all parts which are in movable contact.

The needle vibrating lever and the upper bearing for the vertical shaft should be oiled through the opening (L8, Fig. 34) at the upper left rear end of the arm.

All connections of the upper stitch rotating mechanism should have oil applied to all movable parts.

Oil should be applied to the needle vibrating connections on the right side of the arm and all parts connected to this mechanism located on the lower end of the needle bar; also applied through the oil hole (L, Fig. 2) in the arm face plate to the needle bar and its connections.

At the back end of the machine, oil should be applied through the opening (F6, Fig. 9) to the rollerway of the cutter carrier cam and its connection, to the cutting lever cam seat, to the buttonhole cutting lever cams and to the lower bearing for the vertical shaft.

Oil should be applied to the oil tube (M7, Fig. 10) for the bed shaft bushing, to the oil tube (C6, Fig. 9) for the rapid feed crank shaft rear bearing and to the oil hole (G7, Fig. 10) in the end of the rapid feed intermediate gear stud.

Oil should be applied to the two oil holes (N7, Fig. 10) in the stop lever bracket as well as to the stop cam (H7, Fig. 10) and all sliding surfaces of the interlocking slide (J7, Fig. 10) located at rear end of the bed.

Through the opening (P5, Fig. 9) in the left hand side of the bed, oil should be applied to the feed wheel cam paths, to the lower stitch rotation connections, to the hinge stud for the lower sector and to the oil holes for the bearings located on the left edge of the bed for the pattern wheel shaft and slide bar.

Oil should be applied to the oil pad for the rapid feed starting pawl (K6, Fig. 9) located immediately above the pawl inside the left edge of the bed and to all movable parts of the rapid feed tripping mechanism located within the bed.

The cam groove of the pattern wheel (U5, Fig. 9) and the operating surface of the pattern wheel ring (R5, Fig. 9) should be oiled; also the connections from it to the stop lever and to the side throw lever.

Oil should be applied to the oil tube (O5, Fig. 9) for the front bed shaft bearing.

After removing the bed end cover (T3, Fig. 6) oil should be applied to all movable parts of the looper mechanism, and to the slide block (P2, Fig. 3) on the forward end of the side throw lever.

Oil should be applied to the movable parts on the work plates (O3 and W3, Fig. 6); that is, to the clamp arm cams, shafts and hinge blocks; also to the two oil holes (Q3 and V3, Fig. 6) in the forward end of each plate which carry oil to the base plate slide rod (Q2, Fig. 3).

Swing each work plate (O3 and W3, Fig. 6) out and apply oil to the oil hole in the left side of the base plate immediately above oil hole (S2, Fig. 5) for the side throw lever shaft; also apply oil to the looper mechanism, to the feed wheel cam paths, to the left and right clamp carrier slides and to the oil hole (U2, Fig. 5) for the feed wheel axis stud located beneath the cutting levers in the cutting lever bracket.

Insert the tip of the oil can into the forward right hand opening (R, Figs. 3 and 8) in side of the bed and apply oil to the



forward bearing (Z, Fig. 3) of the rapid feed crank shaft and apply oil to the oil holes for the pattern wheel shaft and slide bar located on the lower edge of this opening.

Oil should be applied to the hinge stud for the clamp closing lever (D5, Fig. 8), to the engaging stud (F4, Fig. 8) and latches connected to the operation of this mechanism as well as to all movable parts connected with the starting mechanism.

Oil should be applied to the two oil holes for the buttonhole cutting shaft, to the oil cup in the hub of the cutting shaft pulley (J4, Fig. 8), to the oil hole (H4, Fig. 8) in the support for the right hand end of cutting shaft and to the hole in the head of the hand crank cap screw (K4, Fig. 8) on the right end of the cutting shaft. Arm Shaft should be oiled through the oil holes (C and N, Fig. 2).

It is extremely important that the oiling of the machine be carried out diligently each day, using **"TYPE B"** or **"TYPE D" OIL**, sold only by Singer Sewing Machine Company. (See inside front cover for description of oils). This will be an investment that will yield exceptional returns as it will reduce the demand for service as well as reduce the cost of upkeep and will greatly increase the life of the machine.

## INSTRUCTIONS FOR ADJUSTERS AND MACHINISTS

### Needle Vibrating Mechanism

The needle vibrating mechanism is actuated by means of a cam on the upright shaft. When this shaft starts to rotate, the cam moves the connecting rod (F, Fig. 2) back and forth, causing it to rock the bell crank (J, Fig. 2) which in turn moves the link (K, Fig. 2) up and down, carrying with it the reciprocating rod (M, Fig. 2) which has the vibrating ring (H, Figs. 2 and 12) attached to its lower end. As the vibrating ring moves up and down, it swings the needle vibrating switch (W7, Fig. 13) side-ways, causing the roller (V7, Fig. 13) to be switched from one

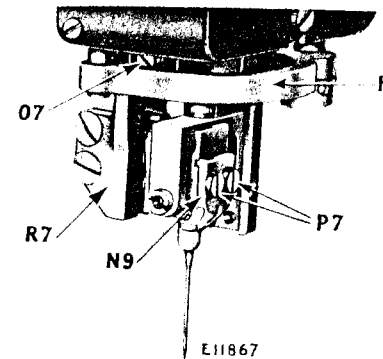

Fig. 12. Needle Vibrating Mechanism

groove to the other in the gauge plate (R7, Fig. 13). The roller (V7) is mounted upon the needle bight adjusting lever (T7, Fig. 13) which in turn is mounted on the bridge of the needle bar so that when the roller is switched in the grooves of the gauge plate (R7), the needle is vibrated from side to side.

### To Align the Needle

To ascertain the alignment of the needle, loosen the needle holder clamping screws (P7, Fig. 12) and slide the needle holder so that the left hand edge is flush with the corresponding edge

of the needle holder slide, as shown at N9 in Fig. 12, and tighten the screws. Inspect the straightness of the needle and replace if necessary. Now clamp a piece of light card under the clamp checks, raise the work clamp carrier side throw lever lock pin (B6, Fig. 9) up and out of the pattern wheel (U5, Fig. 9) and then with wrench on pattern wheel clamping nut (S5, Fig. 9), turn the machine up the first side of buttonhole, at the same time making a row of light punctures in the card with the needle on the slit or central vibration. Continue up and around the eye. The needle point, while coming down the last side of the buttonhole, should exactly enter the card in the first line of punctures. If the two lines do not coincide, it will be necessary to adjust the gauge plate (R7, Fig. 13) to the right or left as may be required.

While the machine is still on the last side of the buttonhole with the gauge plate (R7) towards you, move the needle vibrating ring (H, Fig. 12) to its lowest point, then loosen the two screws (S7 and B8, Fig. 13) and turn the adjusting screw (O7, Fig. 12) to bring the two lines of needle punctures in line with each other, then tighten the two screws (S7 and B8).

Turn the machine by hand and note the movement of the roller (V7, Fig. 13) as it passes from the slot of the gauge plate (R7) into the needle vibrating switch (W7, Fig. 13) and then from the switch (W7) back into the second slot of the gauge plate (R7). Should the roller drag upon the side wall of the gauge plate or switch, it will be necessary to change the length of the rod (F, Fig. 2). After making adjustments of the rod (F), the lock nuts (E and G, Fig. 2) should be tightened.

After making the above adjustments, turn the machine with the wrench on the pattern wheel clamping nut (S5, Fig. 9) to the starting position as referred to under "**Caution**" on page 61.

### To Regulate the Cutting Space

Having followed the instruction for aligning the needle, again clamp a piece of light card under the clamp checks, raise the work clamp carrier side throw lever lock pin (B6, Fig. 9) up and out of the pattern wheel (U5, Fig. 9) and then with wrench on pattern wheel clamping nut (S5, Fig. 9), turn the machine up the first side of the buttonhole, at the same time making a row of light punctures in the card with the needle on the slit or central vibration. While on the first side of the buttonhole, loosen the needle holder clamping screws (P7, Fig. 12) and slightly adjust the needle holder to the left. The needle, while coming down the last side of the buttonhole, should enter the card about .006 inch to the right of the first line of punctures. This distance may have to be changed according to the thickness and textures of the material being sewn, as the heavier grades of materials require more cutting space than the lighter fabrics and, therefore, a greater distance between the two parallel lines of needle punctures may be required.

**To Regulate the Width of Bight.** The width of bight or stitch is regulated by the screw (U7, Fig. 13). To increase the width

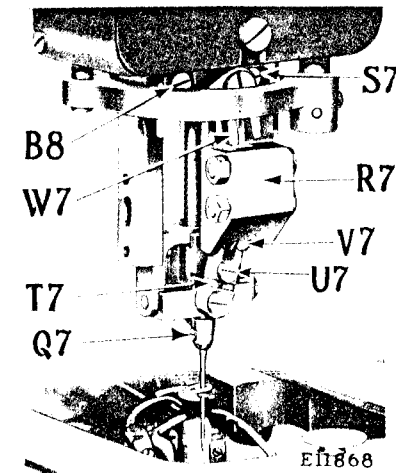

Fig. 13. Needle Vibrating Mechanism Showing Adjustments for Regulating Width of Bight and Cutting Space

of bight or stitch, loosen the screw (U7) and move it upwardly. To decrease the width of bight, loosen the screw (U7) and move it downwardly.

When changing the width of bight or lateral throw of the needle, it will be necessary to adjust the loop retainer (A9, Fig. 15) and the non-threaded looper (V8, Fig. 14), as instructed below and on pages 34 and 36.

### To Replace and Time Non-Threaded Looper

When replacing loopers, first remove work clamp plates and throat plate (12, Fig. 4), then place wrench on pattern wheel clamping nut (S5, Fig. 9) and turn until stop lever operating plate (Z5, Fig. 9) rides on the pattern wheel ring (R5, Fig. 9), allowing the machine to be turned by hand. Place non-threaded looper (V8, Fig. 14) on seat of looper rocker (U8, Fig. 14) and turn machine until the needle bar, after descending to its lowest point, has risen so that the **lower timing mark** on needle bar is even with top of top needle bar bushing, and the point of the non-threaded looper has advanced to center of a true needle. At this position, the point of the non-threaded looper should be

adjusted to centre of needle, as shown at T8 in Fig. 14, and adjusted sidewise so that it just clears the needle.

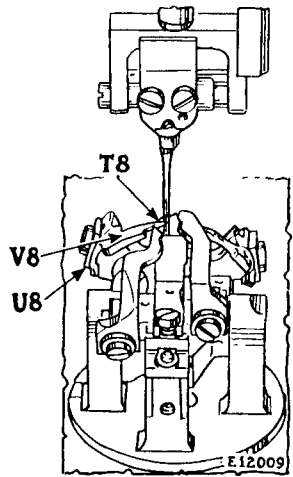

Fig. 14. Showing Correct Timing of Non-Threaded Looper

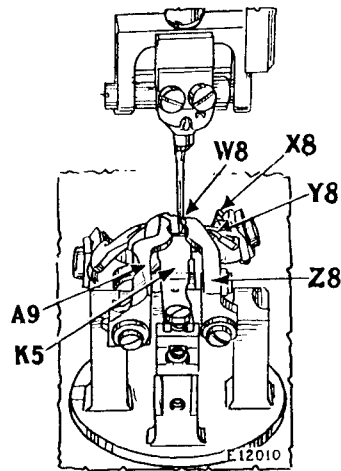

Fig. 15. Showing Correct Timing of Threaded Looper

#### To Adjust the Needle Guard

The needle guard (K5, Fig. 15) should be set as close as possible to the needle without deflecting it. To set the needle guard in the correct position, loosen its two screws and move the needle guard forward or backward, as required, then securely tighten the two screws.

#### To Replace and Time Threaded Looper

Turn hand wheel over until looper (Y8, Fig. 15) can be inserted on looper rocker seat (X8, Fig. 15), then turn machine until the needle bar, after descending to its lowest point has risen so that the **lower timing mark** on needle bar is even with top of top needle bar bushing and the point of the threaded looper has advanced to the centre of the needle. At this position, the looper point should be adjusted to centre of needle, as shown at W8 in Fig. 15, and adjusted sidewise so that it just clears the needle.

#### To Replace and Adjust Right Hand Loop Retainer

It is first advisable to adjust the right hand loop retainer (Z8, Figs. 15 and 17). The right hand loop retainer should be set in height so that it just clears the threaded and non-threaded loopers, or so that there is sufficient space between the top side

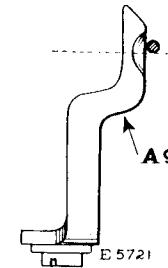
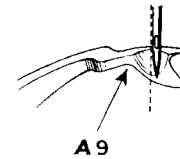

Fig. 16. Showing Correct Relative Positions of Left Hand Loop Retainer and Needle

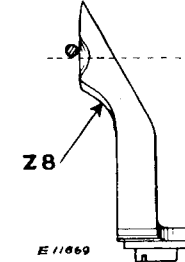
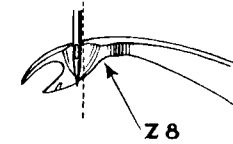

Fig. 17. Showing Correct Relative Positions of Right Hand Loop Retainer and Needle

of the looper and underside of the loop retainer for the thread being used to pass through. The loop retainer should also be adjusted sidewise so that, as the needle descends, the loop retainer just clears the needle on the side as the loop retainer is retreating as shown in Fig. 17, which shows a side and top view of the loop retainer correctly adjusted. The right hand loop retainer should be adjusted forward or back so that the needle in descending will penetrate the loop held suspended on its horn in such a position that the right hand loop retainer point does not project over the further edge of the non-threaded looper thus to prevent the point

striking or dragging against the further side of the loop held upon the non-threaded looper, as shown in Fig. 18.

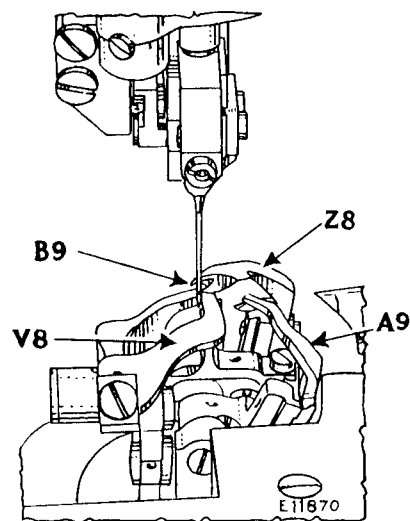

Fig. 18. Showing Correct Relative Positions of Loop Retainer and Non-Threaded Looper

#### To Replace and Adjust Left Hand Loop Retainer

To replace and adjust left hand loop retainer (A9, Fig. 18), first obtain about the proper amount of bight required by the needle as instructed on page 33. This loop retainer should be set in height so that there is just sufficient space between the top side of the threaded looper and the underside of the loop retainer for the thread to pass through. It should also be adjusted side-wise so that, as the needle descends, it just clears it on the side, as shown in Fig. 16, which shows a side and top view of the left hand loop retainer correctly adjusted. The left hand loop retainer should be adjusted forward or back so that the needle in descending will penetrate the loop held suspended on its horn.

It may be necessary, in order to obtain correct setting for either the left or right loop retainer, to use shims which are made in different thicknesses, viz., 250074, .005" thick, 250449, .010" thick, 250450, .020" thick and 250537, .030" thick.

#### To Replace and Adjust the Throat Plate

When replacing the throat plate (12, Fig. 4), see that its underside just clears the loop retainers and the top set about flush with the top of the clamp plates. The throat plate should be adjusted sidewise so that the needle just clears the cord or range of opening in the throat plate but not so as to allow the loop retainer to rub against the rib of the throat plate.

#### To Remove and Replace the Looper Frame

Press in the buttons (S3 and U3, Fig. 6) and at the same time draw the bed end cover (T3, Fig. 6) toward you to remove it from the machine, then turn the looper thread tension releaser (X, Fig. 3) up to clear the right hand edge of the looper frame (W, Fig. 3). See that the sewing mechanism is in stopping position with the interlocking slide (J7, Fig. 10) locked in the notch of the stop cam (H7, Fig. 10). Follow the instructions under the head "Caution", page 61 and ratchet the machine about half way up the first side of the buttonhole, remove the link screw (L2, Fig. 3) to give access to the looper frame screw and then remove three looper frame screws. Now replace link screw (L2) temporarily, to retain the setting of the loopers, and carefully withdraw the looper frame (W) from the machine.

To replace the looper frame (W) make sure that the machine is in the same position as referred to in the preceding paragraph with the needle bar gauge plate (R7, Fig. 12) turned towards the rear of the machine. Turn the stitch forming mechanism in the looper frame (W) so that the post for the throat plate (12, Fig. 4) is to the front, set the looper driving crank (D2, Fig. 3) with the  $\frac{3}{16}$ " hole (E2, Fig. 3) in the flange of crank to the left and slightly below the horizontal position. Carefully guide the rear edge of the chip guard (Q, Fig. 3) between the underside of the lower cutting lever and the top face of the feed wheel, and as the looper frame (W) is gently pushed to the rear, guide it so that its position pins enter the two pin holes and so the fork end of the loop retainer slide (B2, Fig. 3) enters the space between the two adjusting nuts (A2 and C2, Fig. 3) which are locked in position on the loop retainer driving bar (8, Fig. 3). At the same time slightly turn the looper driving crank (D2, Fig. 3) back and

forth until the driving rollers on the forward end of the bed shaft enter the intermittent wheel which is attached to the rear side of the looper frame (W) and at the same time gently rotate the looper frame back and forth a slight amount so that the rotating gear on looper bracket will go into proper mesh with the lower stitch rotating sector to bring the looper mechanism in alignment with the needle bar. Push the looper frame snug against its seat on the machine, then again remove the link screw (L2, Fig. 3) and replace the three clamping screws and the link screw (L2). (Always make sure the looper frame (W) is snug and square against its seat before tightening the three screws). Then ratchet the machine to starting position as instructed on page 61.

### Alignment of the Needle and Looper Frame

The looper frame (W, Fig. 3) and the needle are aligned before the machine is shipped so that the looper mechanism and the needle, at all points of rotation, are in perfect alignment; that is, the looper frame seat on the frame itself and the machine bed are filed and scraped to adjust the looper mechanism just the right amount in the direction of longitudinal travel and revolved on its seat to adjust it at right angles to the travel of the machine, so that when the machine is in the position where the needle is alongside of either of the loopers or the loop retainers, there will be no change in their relative position during this rotation. When the looper frame is so located, it is doweled in this position and with ordinary care in the handling of the machine, this position should be maintained. For this reason the looper frame should always be replaced upon its own machine according to the identification number. If a new looper frame should be fitted to the bed of the machine, it will be necessary that the looper frame be fitted very carefully and in a like manner. Should the bed shaft, the loop retainer cam or the looper driving crank be replaced, retiming of the looper mechanism will be necessary; but before this can be correctly done a check should be made as to the alignment of the needle and the looper frame, during the rotation of the looper mechanism and needle bar.

The straightness of the needle bar should be ascertained and corrected if necessary. Remove the upper rear hinge screw for the stitch rotating connection so that the needle mechanism can be manually rotated. Then select a new needle and inspect the trueness of its point by rolling it on its shank on a flat surface. Remove the needle holder and clean off any burrs or dirt which would tip the needle holder on its seat, then replace the needle holder in position, as shown at N9, Fig. 12 (see description "**To Align the Needle**", page 31) and insert the inspected needle. Now firmly hold a piece of paper under the point of the needle and make a slight impression with the needle point, then revolve

the needle bar and note whether the point revolves without describing a circle. Should the needle point describe a circle, it will indicate that either the needle is still bent or that the seat of the needle holder is throwing the needle point. This incorrect condition should be thoroughly corrected as the needle point will be the foundation upon which the looper mechanism will be aligned and timed. After correcting the alignment of the needle point, assemble the upper rotating sector so that when the machine is on the last side of the buttonhole, the needle bar gauge plate (R7, Fig. 12) is exactly positioned squarely to the front and the screw hole on the rear end of the upper stitch rotating connection is directly over the hole on the end of the upper stitch rotating lever, then assemble the hinge screw. **Note that the identification number on the looper bracket frame (W, Fig. 3) agrees with the number on the front edge of the machine bed,** then turn the hand wheel (D, Fig. 2) until the needle moves down alongside of the threaded looper and adjust so that it just touches the blade of the needle. Ratchet the machine to the eye end of the buttonhole and note the relation between the needle and side of the threaded looper as they both revolve. The relative position of each should be maintained during the rotation but should they crowd together or gap open, it will indicate that the looper bracket frame is not correctly seated upon the machine. This condition should be corrected by removing all burrs and dirt from the seats and the dowel pin holes of the looper bracket frame and the machine bed until no further crawl is noted between the threaded looper and the needle. As the machine is on either the first or last side of the buttonhole a greater percentage of time, the looper frame position is vital to the loopers longitudinally and to the loop retainers laterally.

### To Assemble Looper Bracket to Cut After Machines

The removal of the looper bracket (M2, Fig. 3) with its assembly from the looper frame (W, Fig. 3) will destroy the adjustment of the loopers and loop retainers with respect to the needle. This condition will require that the correct adjustment be restored when reassembling. After replacing and adjusting nuts (K2, Fig. 3) so that the looper bracket assembly has a free running fit without any end play, replace on the looper driving bar (H2, Fig. 3) the four adjusting nuts (G2, Fig. 3) with their two washers between the two nuts of each pair and with the looper driving connection (J2, Fig. 3) between the pairs, then assemble the looper driving connection slide rod and its link to the driving crank. Position the lower face of the bottom adjusting nut flush with the lower end of the looper driving bar (H2, Fig. 3) and lock it in position with the second nut. Adjust and lock the upper pair of adjusting nuts (G2) in position

so that the looper bracket (M2) will turn freely without the looper driving connection (J2) having any shake between the adjusting nuts (G2). Now replace on the loop retainer driving bar (8, Fig. 3) the four adjusting nuts (A2 and C2, Fig. 3) with their two washers between the two nuts of each pair. Position the lower face of the largest adjusting nut (A2)  $\frac{1}{8}$  inch below the extreme end of the driving bar (8) and lock it in position with the second nut. Adjust and lock the upper pair of adjusting nuts (C2) about  $\frac{3}{16}$ " above the lower pair of adjusting nuts (A2). Now place the looper frame (W) on the machine as instructed on page 37.

The above adjustment of the adjusting nuts (G2) on the looper driving bar (H2) should position the loopers correctly so that the point of the threaded looper (Y8, Fig. 15) and non-threaded looper (V8, Fig. 14) will be at the center of the needle on their respective strokes when the needle bar has risen, so that the lower timing mark on needle bar is even with the top of needle bar bushing. It may be found that the point of one of the loopers is ahead or back of the center of the needle. If such is the case, make sure that the distance between the points of the loopers is  $\frac{5}{16}$ " (measure by passing a  $\frac{5}{16}$ " shaft between the points so that the shaft just drags upon each of the points as the shaft is passed between). Then readjust the adjusting nuts (G2, Fig. 3) for the looper driving bar (H2, Fig. 3) up or down, as the case may be, to bring the point of the looper to the center of the needle. Any adjustment of the looper driving bar moving the looper to or from the center of needle will throw the other looper in the opposite direction, therefore each looper should be checked with respect to its own dip of the needle.

The loop retainer driving bar adjusting nuts (A2 and C2, Fig. 3) should now be positioned to raise or lower the driving bar (8), thus positioning the loop retainer seat on the carrier (O, Fig. 3) in a vertical position when loop retainer slide (B2, Fig. 3) is at its extreme throw. When the correct position of loop retainer driving bar is obtained, it will bring the point of the right hand loop retainer (Z8, Fig. 15) just to the further edge of the non-threaded looper (V8, Fig. 14) as the non-threaded looper advances and the right hand loop retainer remains stationary. Should the right hand loop retainer overlap or fail to come up to within a few thousandths of the further edge of the non-threaded looper, it will be necessary to adjust the loop retainer by removing or adding shims, as referred to on page 37. After making the adjustments to the looper driving bar (H2, Fig. 3) and the loop retainer driving bar (8, Fig. 3), ratchet the machine as referred to on page 61 to see that there is no bind to the adjusting nuts as the looper bracket (M2, Fig. 3) is rotated.

## To Time the Looper Driving Crank on Cut After Machines

When replacing a looper driving crank (D2, Fig. 3) to the looper frame (W, Fig. 3), position the looper driving crank gear in proper mesh with the looper driving gear so that the timing marks on each gear are in line with each other. Turn the looper driving crank until the set screw on the crank gear is downward and in direct line with the screwdriver hole in the bottom edge of the looper frame (W, Fig. 3) and holding the driving gear and crank gear in this position, turn the looper driving crank (D2, Fig. 3) so that the  $\frac{3}{16}$ " hole (E2, Fig. 3) in its flange is to the left and the lower edge of hole is over and exactly in line with the top edge of the left hand counterbored screw hole (F2, Fig. 3) in the flange of the looper driving crank bushing which is directly under the flange of the looper driving crank (D2) when looper frame (W) is in an upright position, then slightly tighten set screw. Now place looper frame (W) on the machine as instructed on page 37. After making sure that the looper driving bar (H2) is assembled with the lower adjusting nut (G2, Fig. 3) flush with the lower end of the looper driving bar (H2), as instructed on page 39, set the non-threaded looper (V8, Fig. 18) so that the forward edge of the non-threaded looper (V8) seat is flush with the forward edge of the seat on the looper carrier (P8, Fig. 5). Turn the hand wheel (D, Fig. 2) until the needle bar, after descending to its lowest point (on the depth stitch or vibration nearest to the non-threaded looper) has risen so that the lower timing mark on needle bar is even with the top of the top needle bar bushing and advance or retard the looper driving crank (D2, Fig. 3) a very slight amount until the point of the non-threaded looper (V8, Fig. 18) is opposite the center line of the needle. (This may be done by turning the hand wheel (D) over until it is noted that the looper driving crank remains stationary and holding the hand wheel (D) in this position and with a punch striking the  $\frac{3}{16}$ " hole in the flange of the looper driving crank.) Now turn the hand wheel (D) over until the needle bar, after descending to its lowest point (on the slit stitch or vibration nearest to the threaded looper), has risen so that the lower timing mark on needle bar is even with the top of top needle bar bushing, then position the point of the threaded looper (Y8, Fig. 15) so it is opposite the center line of the needle. Carefully measure the distance between the points of the non-threaded looper (V8, Fig. 18) and the threaded looper (Y8). Should the distance be greater than  $\frac{5}{16}$  inch, turn the looper driving crank (D2, Fig. 3) a slight amount in a counter clockwise direction while holding the hand wheel (D) or should the distance be less than  $\frac{5}{16}$  inch, turn the looper driving crank (D2) a slight amount in a clockwise direction. Now proceed as before to bring the needle bar to the timing mark on the depth stitch

and reposition the non-threaded looper (V8) to the centre of the needle and then bring the needle bar to the timing mark on the slit stitch and reposition the threaded looper (Y8) to the center of the needle. Again carefully measure the distance between their points and continue to reposition the looper driving crank and readjust the two loopers until a  $\frac{5}{16}$  inch shaft just drags upon each of the points as the shaft is passed between the points. Great care must be taken in positioning the looper driving crank and the two loopers so that the distance between their points is exactly  $\frac{5}{16}$  inch and their points are exactly at the center of the needle on its respective vibration when the needle bar has risen to the lower timing mark on the needle bar. Now make sure there is no end play in the bearing of the looper driving crank (D2) after which the pin hole for the looper driving crank may be drilled and reamed.

To drill and ream the pin hole for the looper driving crank gear, remove the looper frame (W, Fig. 3) from the machine, turn the two gears until their timing marks are in line, then remove the cap screw for the looper driving gear and lift the looper driving gear off its stud and proceed to drill each side of the hub of the looper driving crank gear half way into the shaft. After reaming hole to the proper depth, remove the gear from the shaft end of the looper driving crank and thoroughly clean out all chips and burr the shaft where the pin hole breaks through and reassemble the parts onto the looper frame with the timing marks of the two gears in line with each other.

### Rapid Feed Mechanism

The purpose of the rapid feed is to move the work quickly (in starting) from buttonhole cutting position to sewing position and at the completion of the stitching of the buttonhole to quickly move the work from sewing position to buttonhole cutting position.

The rapid feed mechanism is entirely automatic in operation and is actuated by driving means independent of that which operates the stitch forming mechanism.

When the machine is started in operation, the rapid feed is actuated first by the action of the stud (Q4, Fig. 8) riding up the incline of the latch (P4, Fig. 8), causing it to rock the shaft (M4, Fig. 8) which in turn trips the latch (M6, Fig. 19) and allows the rapid feed starting pawl (K6, Fig. 19) to engage the stud (L6, Fig. 19). As the pawl engages the stud, it causes the fork (J6, Fig. 19) to withdraw the sleeve (O6, Fig. 19) from the clutch levers, thereby engaging the clutch disc (H6, Fig. 19) which rotates the shaft (N6, Fig. 19), causing the work clamp plates with the work to be moved to a sewing position. The rapid

feed clutch is held in engagement by the rapid feed slide bar fork extension plate (P6, Fig. 20) as it drops into the notch in the

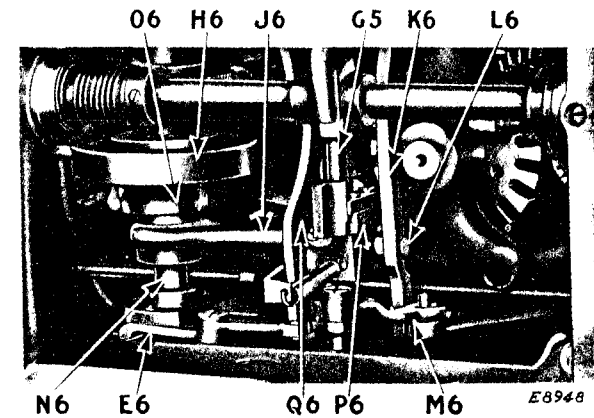

Fig. 19. Rapid Feed Suspended

rapid feed slide bar lock (Q6, Fig. 20). When the work clamps reach the sewing position, the rapid feed movement is suspended by the tripping point (V5, Fig. 9) on the inner side of the pattern wheel (U5, Fig. 9) coming into contact with the latch (W5, Fig. 9 or E6, Fig. 20), which rocks the rapid feed slide bar lock (Q6, Fig. 20) out of contact with the rapid feed slide bar fork extension plate (P6, Fig. 20) and allows the fork (J6, Fig. 20) to move the sleeve (O6, Fig. 20) into contact with the clutch levers, thereby disengaging the clutch disc (H6, Fig. 20) and stopping the rapid feed movement.

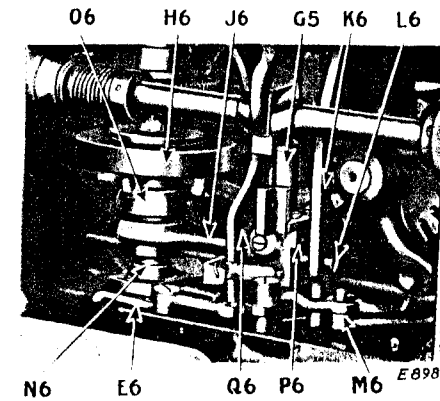

Fig. 20. Rapid Feed in Operation

At the completion of the stitching of the buttonhole, the rapid feed is actuated a **second time** by the downward action of the interlocking slide (J7, Fig. 10) raising the end of the rapid feed starting lever (L7, Fig. 10), causing it to rock the shaft (M4, Fig. 8) which in turn trips the latch (M6, Fig. 19) and allows the rapid feed starting pawl (K6, Fig. 19) to engage the stud (L6, Fig. 19). As the pawl engages the stud, it causes the fork (J6, Fig. 19) to withdraw the sleeve (O6, Fig. 19) from the clutch levers, thereby engaging the clutch disc (H6, Fig. 19) which rotates the shaft (N6, Fig. 19) causing the work clamp plates with the work to be returned to a starting position. The rapid feed movement is finally suspended by the tripping point (X5, Fig. 9) on the inner side of the pattern wheel coming into contact with the latch (W5, Fig. 9 or E6, Fig. 20) which rocks the rapid feed slide bar lock (Q6, Fig. 20) out of contact with the rapid feed slide bar extension plate (P6, Fig. 20). This allows the fork (J6, Fig. 19) to move the sleeve (O6, Fig. 19) into contact with the clutch levers, thereby disengaging the clutch disc (H6, Fig. 19) and stopping the rapid feed movement.

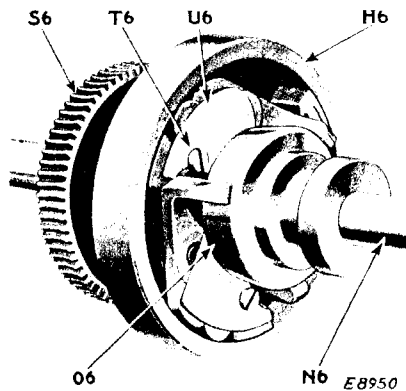

Fig. 21. Rapid Feed Clutch Showing Position of Sleeve when Clutch is Disengaged

**To Remove the Clutch Rollers.** It is important that the clutch rollers (E7, Fig. 22) be absolutely true and of equal diameter so that they will all grip against the rim of the rapid feed driving disc. The clutch rollers may become so worn as to interfere with the perfect operation of the clutch, allowing the clutch to slip. When this occurs, the worn clutch rollers should be removed and new rollers inserted in their place as follows:

Remove the pattern wheel. This will give access to the clutch rollers through the opening in the left side of the machine. Then

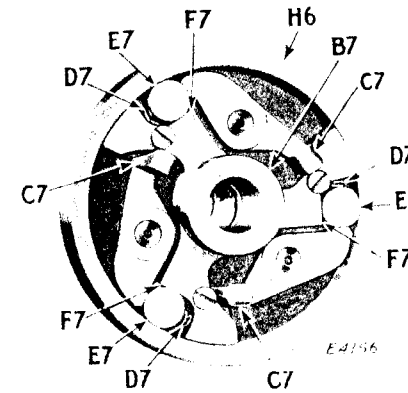

Fig. 22. Rapid Feed Clutch Disc Showing Clutch Rollers, Springs, Levers and Carrier Assembled

slightly loosen the screw (T6, Fig. 21) which holds the retainer plate (U6, Fig. 21) in position and remove the plate. **Do not take out the screw (T6).**

Using the tweezers furnished with the machine, carefully draw out the clutch roller (E7, Fig. 22), at the same time inserting a thin piece of sheet metal between the roller and the plunger (D7, Fig. 22) to keep the spring and plunger from dropping out of the retainer. In case the spring and plunger should drop out of the retainer, dip them in heavy grease which will help to hold them when they are replaced.

**To Replace the Clutch Roller,** hold the roller with the tweezers and place it into position in the clutch, at the same time holding the spring and plunger in the retainer with the thin piece of sheet metal and after the roller has been replaced, withdraw the piece of sheet metal. Then replace the retainer plate (U6, Fig. 21), using the tweezers furnished for the purpose, and tighten the screw (T6, Fig. 21).

To remove the remaining two clutch rollers, turn the end of the pattern wheel shaft (S5, Fig. 9) with a wrench until the rollers are brought to a position where they can be reached. The rollers can then be removed and replaced as previously instructed.

In case the springs (D7, Fig. 22) should become weakened or broken, they can be removed and new springs inserted in their place after removing the clutch rollers as previously instructed.



### Buttonhole Cutting Mechanism

It is important that the buttonhole cutting mechanism of the machine be kept in first class condition and correctly adjusted to ensure perfect cutting of the buttonholes.

As the buttonhole cutter cuts the hole after stitching, it is necessary to have the cutter in perfect alignment so that it will cut exactly in the center of the buttonhole without cutting the stitches.

**Buttonhole Cutting Knife.** The buttonhole cutting knife (D3, Fig. 5) is made in two styles: for eyelet-end buttonholes and for straight buttonholes. The cutting knife used must conform with the cutting block which is set in the machine. (See list of cutting blocks and cutting knives on pages 5 to 10 inclusive.) For example, in Machine 99w110, for cutting 1" eyelet-end buttonholes with medium size eye, without bar, cutting knife 256120 must be used with cutting block 256106, and for cutting  $\frac{3}{4}$ " straight buttonhole, cutting knife 256122 must be used with cutting block 256113.

The knife is held in position on the lower cutting lever and can be adjusted sidewise or endwise as may be necessary to align the knife with the center of the stitching of the buttonhole. The adjustable stop (C3, Figs. 5 and 36) is provided to correctly locate the knife endwise so that the eyelet end of the knife will cut exactly in the eye of the buttonhole. When this stop is once set in position, it is unnecessary to change it as the knife can be removed and replaced or a new knife substituted, the correct alignment of the knife endwise being determined by having the projection on the stop (C3) enter the notch in the right side of the knife. The buttonhole cutting knives are made interchangeable, having the same relative position in the machine.

In case the knife is not cutting in the center of the buttonhole, it can be adjusted sidewise by means of the screw (J9, Fig. 36) at the right of the knife and a similar screw at the left of the knife, after loosening the clamping screw underneath the knife in the knife holder. To move the knife to the right, take out the knife as instructed, loosen the clamping screw underneath the knife in the knife holder, then loosen the screw (J9, Fig. 36) at the right of the knife and tighten the screw at the left of the knife. To move the knife to the left, loosen the screw at the left

of the knife and tighten the screw (J9) at the right of the knife. When the correct position of the knife is obtained, firmly tighten the three screws.

To remove the knife (D3, Fig. 36) loosen the hexagon screw (G9, Fig. 36) only enough to loosen the eccentric lever (O9, Fig. 36) and insert the end of the screwdriver in the hole in the eccentric lever (O9, Fig. 36), then turn the lever to the front and lift out the knife. To replace the knife, slide the knife into position from the left so that the projection on the stop (C3, Figs. 5 and 36) will enter the notch on the right side of the knife. Then with the screwdriver, turn the eccentric lever (O9, Fig. 36) as far to the rear as it will go and tighten the hexagon screw (G9, Fig. 36).

The cutting edge of the knife is made parallel with the base (see Fig. 23) A to A, and the knife serves as a master foundation for cutting, while the cutting block is fitted to have the cutting edge of the knife bear evenly the whole length of the block.

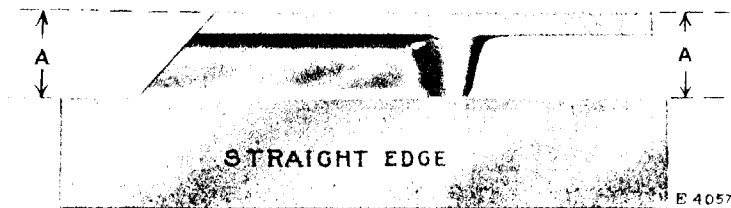

Fig. 23. Perfect Knife Edge

It is very important that the buttonhole cutting knives and cutting blocks are fitted and adjusted with great care, in order to ensure successful results.

### Buttonhole Cutting Knives

99w110	99w111	99w112	Size of Eye	Shape of Eye
256121	255347		.126" x .200"	
256123	255346	252338	.126" x .180"	
256120	255345	252337	.100" x .180"	
256122	255344	252339	Straight	

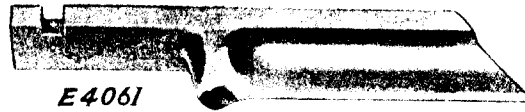

Fig. 24



Fig. 25

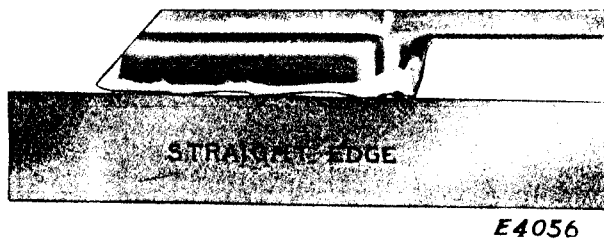

Fig. 26

**Never attempt** to grind the knife by hand. It is quite impractical to grind the cutting blade and eye portion by holding the knife against an emery wheel. The result of grinding by hand is illustrated by Figs. 24, 25 and 26.

The only practical way to re-dress a knife is to lap the cutting surface parallel with its base, as shown in Fig. 23, until the nick or unevenness is removed. This can be accomplished by using Singer Knife Trueing Fixture 232878; then stone the knife to a cutting edge. But this is a slow and tedious undertaking. It is much cheaper to put in a new knife.

**Buttonhole Cutting Block.** The buttonhole cutting block (T2, Fig. 5) is made in various sizes for different lengths and styles of buttonholes. The cutting block used must conform with the pattern wheel which is set in the machine (see list of pattern wheels on pages 5 to 10 inclusive). For example, in Machine 99w110, for cutting 1" eyelet-end buttonholes with medium size eye, without bar, cutting block 256106 must be used with pattern wheel 256127, and for cutting  $\frac{3}{4}$ " straight buttonholes, cutting block 256113 must be used with pattern wheel 256133.

The buttonhole cutting block is fastened to the upper cutting lever by means of the hexagon screw (H9, Fig. 5) on the cutting lever. The cutting block must be pushed back against the stop in the cutting lever, so that when it descends upon the knife, the impression of the knife will be central in the cutting face of the block. All cutting blocks are made interchangeable, having the same relative position in the machine.

To remove the cutting block from the machine, loosen the hexagon screw (H9, Fig. 5) and draw the cutting block toward you. When replacing the cutting block, push it as far back as it will go in the upper cutting lever until it is against the stop, then tighten the hexagon screw.

**To Reface Steel Cutting Block.** When a new knife is placed in the machine and it is desired to use a block that has previously



Fig. 27

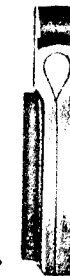

Fig. 28

been in use (see Fig. 27) with another knife, or when the cutting block is so worn that it prevents clean cutting of the buttonholes, it is necessary to file the marks made in the cutting block until the impression of the knife is nearly removed, and only a faint line of impression remains (see Fig. 28). Care should be taken in filing not to entirely remove the mark of the knife at any point.

After filing, insert the cutting block in position on the cutting lever; then slowly turn the cutting shaft by hand, bringing the knife into contact with the cutting block, with only enough pressure to ensure cleanly cut buttonholes. After the impression is made on the block by the knife, back up the knife out of contact with the cutting block and remove the cutting block from the machine and examine the mark to ascertain if the knife registers accurately with the old marks of the former knife.

The correct registration of the knife and cutting block is illustrated by Figs. 30 and 32. Should knife not accurately regis-

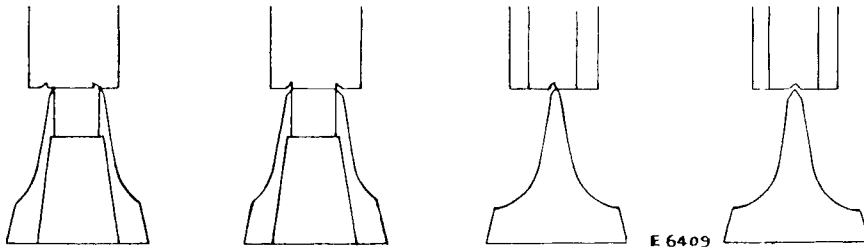

Fig. 29

Fig. 30

(Illustrations Double Size)

Fig. 31

Fig. 32

ter in the old marking (see Figs. 29 and 31) the cutting block should be filed until nothing but a faint line of the knife remains. When this is done, place the block in position in the machine again and turn the cutting shaft to again bring the knife and block into contact, after which remove the block and see if the knife has made an even mark of equal depth in the cutting block. If the whole complete outline of the knife is not shown, it will not cut the buttonhole properly and must be filed until a perfect impression is shown.

### Proper Use of Cutting Blocks

To obtain the best results, a cutting block for each different size buttonhole should be used. For example: a cutting block that has been indented by a knife should not be used in connection with a different size or shape knife, as the lines made by the two different knives would cross at the apex of the eye and strands of the material would be forced into the depression made by the first used knife, resulting in improper cutting of the threads of the fabric where the lines of indentation meet.

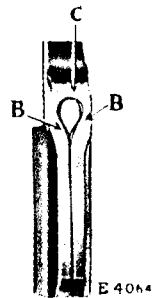

Fig. 33. Result of Two Knives Used on One Block

Fig. 33 illustrates a cutting block that has been used to cut a buttonhole with both a large and a medium size button-

hole cutting knife. It will be noted that the markings made by the two different knives cross each other at the apex B B, also the circular eye markings meet at C. Continued use of this cutting block, under these circumstances, would not improve this condition. In fact, the cutting would become more ragged as the indentation becomes deeper. **Use a different cutting block for each size and shape buttonhole.**

**To Regulate the Pressure on the Cutting Knife.** The pressure on the cutting knife (D3, Fig. 36) is regulated by means of the screw in the wedge shaped device located at the rear end of the upper cutting lever. This screw is accessible through the opening in the upright part of the arm and is located on the left side of the upper cutting lever with its slotted end toward the front of the machine. To increase the pressure on the cutting knife, turn this screw over to the right. To decrease the pressure, turn this screw over to the left. The pressure on the cutting knife should be only heavy enough to ensure clean cut buttonholes. This is particularly important when using a steel cutting block, as too much pressure will ruin the knife.

The correct amount of pressure required for the material being sewn can be ascertained by removing the belt from the cutting pulley and turning the cutting shaft over towards you by means of the hand crank. When the final pressure is exerted on the cutting knife a slight click should be heard as the knife comes into contact with the cutting block after passing through the material.

### Never Use Excessive Pressure on the Cutting Knife

After continuous use, should the buttonhole cutting knife appear to require more pressure by adjusting the cutting wedge, do not increase the pressure until you have carefully examined the cutting knife to make sure that there is not a nick or dull spot in the cutting edge. Remove the cutting block and examine it, and if the indentations of the cutting knife are quite deep, the block should be re-dressed by filing the cutting surface until satisfactory cutting results are obtained.

When the slit and eye are cut clean, no change of adjustment of the cutting mechanism should be necessary until after thousands of buttonholes have been cut. Then, if the knife appears dull, it should be removed and resharpened or a new knife substituted for it.

Only a slight increase of the pressure is necessary by the adjustment of the cutting wedge to further increase the use of the cutting knife.

Only a slight increase of the pressure is necessary by the adjustment of the cutting wedge to further increase the use of the cutting knife.

Should the buttonhole cutting block (T2, Fig. 5) descend upon the work and stop, the cutting of the buttonhole can be completed by turning the hand crank at the right of the machine over toward you, care being taken to bring the hand crank to a full stop. The stopping of the buttonhole cutting block upon the work may be caused by the cutter driving belt being too loose or too much pressure on the cutting block. When this occurs, the belt should be tightened to the required tension or the pressure on the cutting block should be decreased, as the case may be.

#### **To Replace the Buttonhole Cutting Driving Lock 255544**

Remove the cutting shaft hand crank (N4, Fig. 8), the cutting shaft support bracket (O4, Fig. 8) and the cutting pulley (J4), then unhook the spring (L4, Fig. 8).

With machine in starting position, trip the buttonhole cutting mechanism by swinging the buttonhole cutting starting lever (H5, Fig. 8) to the left. Unscrew the two stop plate screws and with the tweezers extract the stop plate. Now remove the buttonhole cutting driving wheel lock (X4, Fig. 8).

To reassemble the mechanism, insert the cutting driving wheel lock (X4) in the slot on the driving wheel (G4, Fig. 8) and make sure that it is a free sliding fit. With the tweezers, insert the driving wheel lock stop plate with the circular mill cut towards the hub and the square mill cut towards the rim of the driving wheel (G4) and insert the two lock washers and screws tightly in place. It is imperative that these two screws are especially tight, as the continual shock which they receive each time the buttonhole cutting mechanism is operated is liable to loosen them. Now replace the end of the lock spring (L4, Fig. 8), swing the buttonhole cutting starting lever (B5, Fig. 8) to the right while holding the driving wheel lock (X4, Fig. 8) against the stop plate and reassemble the pulley (J4), shaft support (O4), hand crank (N4) and cap screw to the end of buttonhole cutting shaft.

#### **To Regulate the Amount of Stretch of the Material Held in the Work Clamps**

After the work clamps descend upon the work, they automatically spread the fabric, stretching it taut under the clamps. The spread of the work clamps should be regulated to stretch the fabric sufficiently to keep the fabric from rising with the needle and to prevent the loss of the needle loop below the work, resulting in the skipping of stitches.

To increase the amount of stretch of the fabric at the eye end or rear end of buttonhole, increase the spread of the work clamps by loosening the lock nuts (A5, Figs. 8 and 34) and turning the adjusting screws (Z4, Figs. 8 and 34) inwardly. The adjusting screws should not be turned in so far as to prevent the work clamp plates coming into contact with the stops (B3, Figs. 5 and 35). The stops enter a slot on the inside edge of the work clamp plates. To decrease the amount of stretch of the buttonhole, decrease the spread of the work clamps by turning the adjusting screw outwardly. When the required amount of stretch of the fabric is obtained, tighten the lock nuts.

To increase the amount of stretch at the bar end or front end of buttonhole, remove the work clamp plates as instructed on page 24 and loosen the two adjusting screws (M9, Fig. 36) and move the screws inwardly or toward each other. To decrease the amount of stretch, move the screws outwardly or away from each other. When the required amount of stretch of the buttonhole is obtained, tighten the two screws (M9).

When changing the amount of spread, the front and rear spreading adjustments should be made so that the front and rear ends of the work clamp plates are actuated equally, thus ensuring a parallel spread.

#### **To Adjust the Automatic Needle Thread Tension Releaser**

The needle thread tension releasing block (G8, Fig. 34) should be adjusted so that the block will position the lower end of the tension releaser lever (K8, Fig. 34) outwardly to hold the tension of the needle thread released when work clamp has moved to the extreme or cutting position with knife edge of lever (K8) on the flat immediately adjacent to the bevel of the block (G8). The needle thread tension is held released during the rapid feed movement by the extension (R8, Figs. 9 and 34) being acted upon by the slide bar (G5, Figs. 9 and 20) when the bar is to the left as illustrated in Fig. 20 and thus holds the releaser lever (K8, Fig. 34) in a tension released position.

To adjust the releaser lever extension (R8, Figs. 9 and 34), manually force the slide bar (G5, Figs. 9 and 20) to the left by pushing against the right end of slide bar. This will force the extension (R8) to the left and should further move the releaser lever (K8) so that the knife edge of lever clears the block (G8) by  $\frac{1}{64}$ ". Failing to have this clearance, place a shim of about  $\frac{1}{64}$ " between the lower end of the releaser lever (K8) and the block (G8), then loosen the two screws (S8, Fig. 34) and hold the lower end of the releaser lever extension (R8) against the stud on slide bar (G5, Fig. 20) and the lower end of the releaser lever (K8) against the shim and block (G8) and then tighten the two screws (S8).

The machine must now be restored to starting position by following the instruction and cautions of ratcheting the machine with the wrench as referred to on page 61.

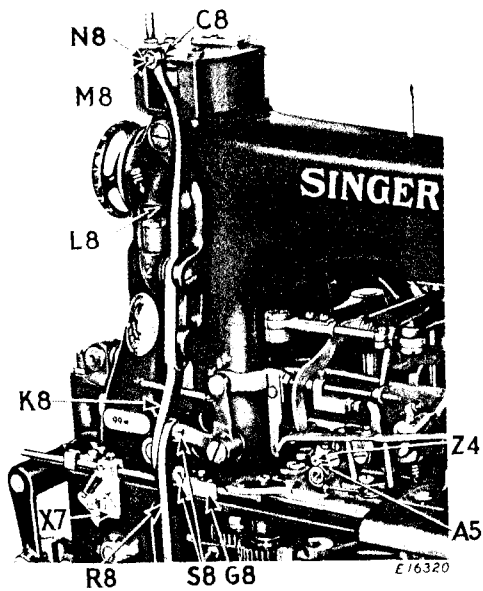

Fig. 34. Adjustment of Automatic Needle Thread Tension Releaser

securely tighten the lock nut (N8).

The tension releasing screw (M8, Fig. 34) should be set so that its flat head bears sufficiently hard against the tension releasing arm as shown at C8, in Fig. 34, to release the tension on the needle thread when the upper end of the tension releasing lever (K8, Fig. 34) is moved inwardly. When the upper end of the tension releasing lever (K8) is moved outwardly, the screw (M8) should permit the tension to be restored on the needle thread. To make this adjustment, loosen the lock nut (N8, Fig. 34) and turn the screw (M8) in or out, as may be required, then

### To Adjust the Looper Thread Tension Releaser

The looper thread tension releaser (X, Fig. 3) should be adjusted to release the tension on the looper thread when the interlocking slide (J7, Fig. 10) is in the notch of the stop cam (H7, Fig. 10). To make this adjustment, set the tension releaser block (Y6, Fig. 10) flush with the end of the screw, having the flat face of the block toward the rear of the machine and parallel with it. Then loosen the set screw in the tension releaser operating lever (Z6, Fig. 10) and position this lever on the looper tension releaser lever rod so that it raises the tension releaser (X, Fig. 3)  $\frac{1}{8}$  inch above the tension discs when the stop motion is unlocked, then tighten the set screw.

### To Adjust Clamp Closing Mechanism

To adjust the clamp closing stud (F4, Fig. 8) and stud locking plate (A4, Fig. 8), back off the adjusting screw (E5, Fig. 8) and slightly loosen the screw stud (B4, Fig. 8) and the screw (J5, Fig. 8), push up the stud locking plate (A4, Fig. 8) and slightly tighten both screws (J5 and B4), press down the finger starting lever (Y3, Fig. 6) and turn the pulley (J4, Fig. 8) by hand until the lever (E4, Fig. 8) lifts the latch (D4, Fig. 8), releasing the stud (F4, Fig. 8) into engagement with the cam path in the pulley (J4, Fig. 8), continue to turn the pulley until the stud (F4) has climbed half way up the disengaging block in the cam path. Then turn the adjusting screw (E5, Fig. 8) until it almost touches the stopping surface of the closing lever (D5, Fig. 8); that is, so there is very slight play between the closing lever (D5) and the adjusting screw (E5) and tighten the pinch screw (F5, Fig. 8). Then continue the rotation of the pulley (J4) until the stud (F4) is locked out of engagement with the cam path of the pulley by the latch (D4), tap the stud locking plate (A4, Fig. 8) downward until the closing lever (D5, Fig. 8) has a very slight play as it floats between the adjusting screw (E5) and the stud locking plate (A4) and securely tighten both screws (B4 and J5).

If this adjustment is properly made, the clamp closing stud (F4) should enter or leave the cam path in the pulley (J4) without the clamp closing stud dragging on either wall of the cam path.

### To Adjust the Clamp Carrying Mechanism

The clamp carrier slides are adjusted for a snug free fit but should the occasion arise for their removal, it is essential that they be reassembled with great care. To disassemble, remove the work clamp plates and take out the four screws (X2, Fig. 5) which hold the spreader base plate retainer blocks (W2, Fig. 5) to the stay plate (Y2, Figs. 5 or 36) and the two screws which hold the spreader base plate (A3, Fig. 5) to the base plate (E3, Figs. 5 and 36). Also remove the left spreader plate (O8, Fig. 35), the spreader connection link (P8, Fig. 35) and the rear screw of the spreader operating fork lever connection (V2, Fig. 5). Slide the spreader base plate (A3) to the right side to remove from the machine and take out the two screws (Q8, Fig. 35) which hold the left clamp carrier slide to the feed lever block.

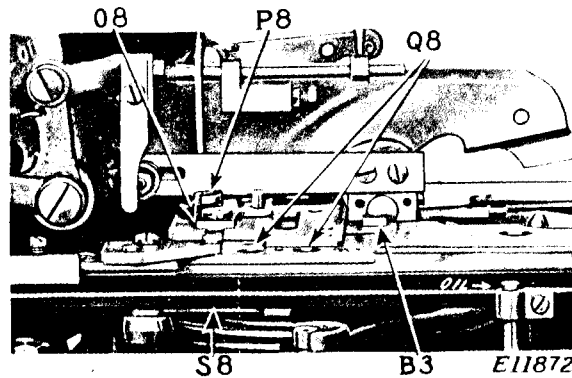

Fig. 35. Adjustment of Clamp Carrying Mechanism

Insert a screwdriver between the clamp carrier feed lever link and underside of the bed of the machine, at S8 in Fig. 35, and press the feed lever link block downwardly out of engagement with the left slide. This will allow the clamp carrying mechanism to slide freely in the bed of the machine, in order to determine the degree of tightness between the clamp carrier slides and the bed of the machine.

Should the base plate or the slides be further disassembled, they should be reassembled and adjusted as follows: As the for-

ward end of each slide is pinned to the slide rod, this determines the proper alignment of the forward end of the slides. The work clamp carrier slide stay plate (Y2) should be assembled so there is an equal amount of clearance between it and the rear ends of the clamp carrier base plate (E3, Fig. 36) at each of its rear ends as at Z2 in Figs. 5 or 36, as this determines the squareness of the stay plate (Y2) at the rear end.

The slides should be adjusted to give a snug fit on the bed of the machine. To obtain this, slightly loosen the three screws

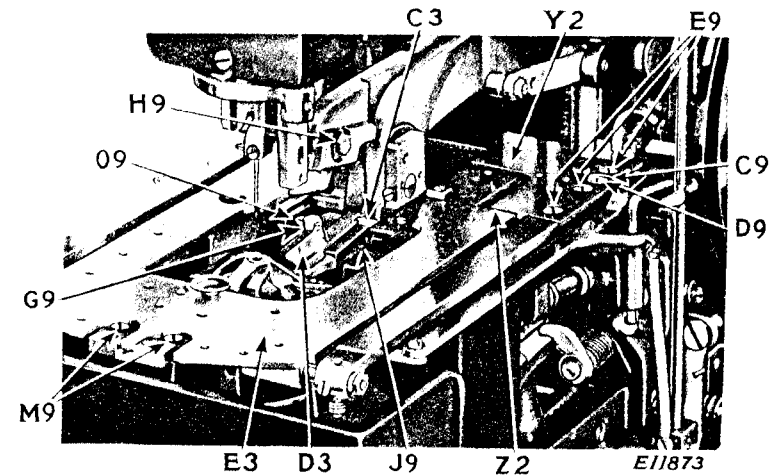

Fig. 36. Adjustment of Clamp Carrying Mechanism

(E9, Fig. 36) which attach the clamp carrier slide stay plate to the right hand clamp carrier slide and also slightly loosen the stay plate lock washer screw (D9, Fig. 36) and tap with a screwdriver the eccentric lock washer (C9, Fig. 36) to the rear until the slides are still free without any looseness, and there is an equal clearance, as represented at Z2 in Fig. 36, on each side of the clamp carrier base plate, then tighten the lock washer screw (D9, Fig. 36) as well as the three clamp carrier slide screws (E9, Fig. 36). **The utmost care must be taken not to turn the eccentric lock washer (C9) so as to cause the slide to bind, as dragging will tend to distort the shape of the eye of the buttonhole and cause unnecessary wear on the feed cam and slides.** The eccentric lock washer (C9) should be just tight enough to permit the work clamp carrier base plate and slides to slide freely without side play. The correct adjustment can be ascertained by removing

the pattern wheel and dropping the side throw lever stud into the vertical slot (N5, Fig. 9), moving the work clamp carrier base plate (E3, Fig. 36) sidewise and by moving the work clamp carrier base plate and slides back and forth, after which securely tighten the three screws (E9, Fig. 36) attaching the clamp carrier slide stay plate to the right hand clamp carrier slide. Then replace the two screws (Q8, Fig. 35) which hold the left clamp carrier slide to the feed lever block, then move the spreader base plate (A3) into position and assemble the two retainer blocks (W2, Fig. 5) and lightly attach their four screws (X2, Fig. 5) and the two spreader base plate screws. Then securely fasten the four retainer block screws and the two spreader base plate screws, also assemble the left spreader plate (O8, Fig. 35), the spreader connection link (P8, Fig. 35) and the rear screw of the spreader operating fork lever connection (V2, Fig. 5).

#### Adjustment of Clamp Locking Mechanism

The clamp closing lever arm (D5, Fig. 8) should be set so that it causes the clamp opening lever (L5, Fig. 9) to lock over the front end of the locking latch (M5, Fig. 9) when the clamp is lowered on the work. If the clamp opening lever (L5) does not lock over the front end of the locking latch (M5), loosen the nut (V6, Fig. 9) and lower the clamp closing lever arm (D5), as required, then tighten the nut (V6).

#### Straight Buttonhole with Rapid Feed at Eye End Exclusive of the 99w113

There are two methods for producing straight buttonholes which eliminates stitches by rapid feeding at the eye end of the buttonhole, both of which require their individual pattern wheels and cutting blocks.

One method utilizes a "stop and start" pattern wheel (AA, Fig. 37) upon which is mounted a pattern wheel ring (BB, Fig. 37) with a disengaging segment (CC, Fig. 37) which can be manually set to produce regular eyelet-end buttonholes or set to cause the sewing to suspend at a position near the eye end of the first side, which in turn starts the rapid feed to move the work

plates around the eye end without stitching, to a corresponding position on the second side, where the rapid feed is suspended

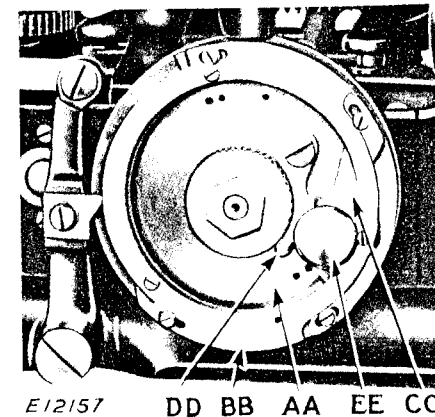

Fig. 37. Showing "Stop and Start" Pattern Wheel

and the sewing resumed. To set the segment (CC) for straight buttonhole, unlock the latch (DD, Fig. 37) and push in the stud (EE, Fig. 37) and release latch (DD) to lock segment (CC) in this position. To set the segment for large eye, unlock the latch (DD) and pull out the stud (EE) and release the latch (DD). Insert the proper cutting block as listed for size and type of buttonhole. (See list of equipment marked \*).

The other method for producing straight buttonholes with rapid feed at the eye end without suspending the sewing to eliminate some of the stitches at this end, requires the use of a pattern wheel with a straight groove and an additional tripping point as well as the rapid feed starting device (X3, Fig. 9). The rapid feed starting lever (X9, Fig. 9) is located on the starting shaft (X4, Fig. 9) so that the operating point of the starting lever (X9) makes  $\frac{1}{2}$ " contact with the tripping point (X8, Fig. 9) as the two points come in contact. The rapid feed starting trip bracket (X3) is located to trip the starting lever (X9)  $\frac{1}{2}$ " ahead of the extreme movement of the work plates on the first

side of the buttonhole. The tripping point located at X2 on the inner surface of the pattern wheel must be positioned to trip off the rapid feed immediately after the operating point (X8) has passed over and tripped the starting lever (X9). Since the rapid feed movement is liable to take place while the needle is in the material, it is important that the above adjustments are followed out so that the rapid feed does not start any earlier nor trip off any later, as this will cause the needle to have an excessive drag upon the material and cause a deflection of the needle that would result in imperfect stitching. The third tripping point on the inner surface of the pattern wheel is located at X2, Fig. 9. (See list of Equipment for Straight Buttonholes marked †.) This tripping point is for the purpose of suspending the rapid feed movement after it has operated during a short period at the eye end of the buttonhole. Such a pattern wheel requires the equipment (X3, Fig. 9) for tripping the rapid feed into action while the sewing mechanism continues.

When making straight buttonholes by this method the correct buttonhole cutting block and straight knife must be inserted in the machine and the lock (X7, Fig. 9) must be turned down. When making all other buttonholes such as eyelet-end or straight without a rapid feed at the eye end or straight with stop and start pattern wheel (see list of Equipment marked \*), the lock (X7) must be turned upward to lift the operating point (X8) so that it will not come in contact with the tripping point on the starting lever (X9), as shown in Figs. 9 and 34.

### CAUTION

Never, under any circumstances, should the looper frame be interchanged from one machine to another. The identification number stamped upon the front face of the frame should always agree with the number stamped upon the front edge of the bed of machine. As each frame is individually fitted and adjusted to its own machine, this ensures that in rotating, the needle bar and the looper mechanism will register with each other at all points of its rotation, thus making the adjustment of the looper mechanism reliable.

This same precaution should also be taken in regard to the intermittent feed driving wheel bracket and the bed extension, each of which have the same identification number stamped upon them as is on the front end of the bed of machine.

Whenever the looper frame is removed from the machine, great care should be taken to prevent any damage to the seat either on the machine or the looper frame and before replace-

ment a close inspection of the seats should be made to see that there are no burrs or dirt that would prevent the seats from squarely repositioning themselves, for this would have a tendency to throw the looper mechanism out of line with the needle bar mechanism.

**Never under any circumstances should the buttonhole cutter starting lever (H5, Fig. 8) be tripped by the operator while the cutting pulley is in motion.**

Before ratcheting the machine with a wrench on the end of the pattern wheel shaft (S5, Fig. 9) for the purpose of making adjustments, always pull the lever (A6, Fig. 9) toward you, to prevent the stop lever operating plate (Z5, Fig. 9) riding on the pattern wheel ring, and at all times that the pattern wheel shaft (S5) is turned with a wrench the disengaging push rod (L3, Fig. 6) should be held down to prevent the cutting starting lever lock (X4, Fig. 8) being tripped. After making the adjustments and while holding down the disengaging push rod (L3), ratchet the machine until it is observed that the starting rod lock (R4, Fig. 8) has moved outward and restored itself under the starting rod block (S4, Fig. 8), then push back the lever (A6, Fig. 9). Failure to carry out these instructions while ratcheting the machine with a wrench is liable to cause damage to the buttonhole cutting safety mechanism as well as damage to the buttonhole cutting starting mechanism.

When the machine has been ratcheted by hand, great care must be taken to see that the needle holder gauge plate block (M3, Fig. 6) is at the right of the needle in its regular starting position before the machine is started in operation. Also see that the interlocking slide (J7, Fig. 10) is in the notch of the stop cam (H7, Fig. 10) at the back of the machine, thus locking the sewing mechanism and placing the looper mechanism in the correct position for cutting. When the interlocking slide is in the notch of the stop cam, push down the rapid feed starting pawl (K6, Fig. 9) as far as it will go to suspend the rapid feed. If these precautions are not carefully observed and the machine is started, the buttonhole cutter will come into contact with the throat plate, throat plate bracket seat or the looper, breaking any one or all of these parts.

As the sewing mechanism and buttonhole cutting mechanism are driven separately, the relative timing of either must not be disturbed, or damage to the machine will result. Always see that the mechanism is in the correct starting position after making adjustments and before starting the machine by power.

Should it be necessary to remove the needle bar or disconnect any part of the needle vibrating mechanism, it is important that the machine is reassembled so that the needle vibrating lever roller (V7, Fig. 13) is in the proper slot of the needle bar gauge



plate (R7, Fig. 13) such that the fork of the needle vibrating switch (W7, Fig. 13) positions itself, when assembled, over the same slot of the gauge plate (R7) that the roller (V7) is running in.

Each pair of bevel gears as well as the looper gears have timing marks which when put together will bring the various mechanisms into proper relation with each other. It is very essential that in the reassembling of the machine that particular care should be taken and the gears checked to see that their timing marks register with each other. Failure to have the feed wheel bevel gear and pattern wheel shaft gear in proper time will cause a distorted shape to the buttonhole and throw the stopping position out of time with either the movement of the work plates or the stitch rotating mechanism. Failure to have all other gears in proper time will cause the looper mechanism to be thrown out of time with the needle, causing the machine to fail to stitch and possible serious and expensive damage to the looper and needle driving mechanisms.

When tightening the hand cutting crank cap screw (K4, Fig. 8), care should be taken to tighten the screw only enough to bring it against the end of the bushing to prevent the screw from becoming loose. If this screw is too tight, it may cause the buttonhole cutting shaft to bind endwise.

**To avoid springing or breaking parts in machine,** it is essential, when machine has once been started, to allow it to complete its cycle automatically.

If it fails to do this at beginning of stitching, it is quite possible that tripping point (V5, Fig. 9) nearest dogging hole (T5, Fig. 9) on inside of pattern wheel needs adjusting backward or toward the dogging hole slightly.

**If stitching is completed and machine fails to complete its cycle from this point,** it may be caused by a loose belt or tight spring in stop lever (D6, Fig. 9), causing machine to stop before it has reached locking point in stop cam. In this case, the hand wheel (D, Fig. 2) at the back of the machine should be turned until it reaches locking point; this starts the rapid feed again, causing machine to complete its cycle.

**If the machine fails to start after pressing down the starting lever,** the engaging stud (F4, Fig. 8) in the clamp closing lever (D5, Fig. 8) may be prevented from engaging in cam path in buttonhole cutting shaft pulley. If stud (F4) is free and it still fails to engage, make adjustments as described on page 55.

**If machine "repeats" by rapid feeding beyond the cutting or stopping position,** the trouble may be caused by the tension on the interlocking slide spring within the stop lever (D6, Fig. 9) being too light, thus allowing the latch (K7, Fig. 10) to hold up

the starting lever (L7, Fig. 10) instead of passing up and beyond to its normal stopping position. This condition may be remedied by increasing the spring tension. Another cause of the rapid feed continuing beyond the cutting position is the failure of the tripping point (X5, Fig. 9) on pattern wheel and the lever (W5, Fig. 9) not moving enough to trip off the rapid feed as related in the following paragraph. The location of the tripping point (X5, Fig. 9) on the pattern wheel (U5, Fig. 9) is important as it positively determines where the machine comes to a stop for the cutting of the buttonhole. The tripping point (X5) should be so located that the rapid feed is tripped and the machine stopped immediately after the stud on the pattern wheel bevel gear has caused the starting rod lock (R4, Fig. 8) to move outward and allowed it to restore itself under the starting rod block (S4, Fig. 8) in the tripping of the buttonhole cutting mechanism. This will stop the machine with the safety lever (V4, Fig. 8) immediately over the rear end of the clearance cut (W4, Fig. 8) on the edge of the pattern wheel shaft bevel gear.

**If machine "repeats" and rapid feeds all the way around the buttonhole,** the trouble may be caused by tripping point (V5, Fig. 9) on pattern wheel and the lever (W5, Fig. 9) that engages the tripping point (V5) not moving enough to trip the rapid feed slide bar lock (Q6, Fig. 20) and releases the slide bar (G5, Fig. 20), thus causing the rapid feed to continue.

For correct position of the parts so that the machine will not fail to trip off the rapid feed, see that the rapid feed slide bar lock (Q6, Fig. 20) is moved downward not more than .010 inch below the lower edge of the locking surface of the rapid feed slide bar fork extension plate (P6, Fig. 20) when the point of the lever (W5, Fig. 9 or E6, Fig. 20) is on top of either of the tripping points (X5 or V5, Fig. 9). Should the lock (Q6) fail to pass below the extension plate (P6), it may require the replacing of either the lever (W5, Fig. 9) or the tripping points (X5 or V5) or all of these parts.

**If machine finishes buttonhole but fails to trip into return rapid feed,** it may be found that the stop lever spring, the stop lever interlocking slide spring or the tripping latch spring are not of sufficient strength or that the hinge screw for the rapid feed tripping latch (K7, Fig. 10) has loosened so that latch fails to work. For correct position of parts so that machine will not fail to trip into return rapid feed, see that the latch (K7, Fig. 10) moves **beyond** the rapid feed starting lever (L7, Fig. 10) so that it will be about  $\frac{1}{16}$ " below and  $\frac{1}{16}$ " back under the starting lever (L7), as shown in Fig. 10, when actuated by stop motion.

## Skipping of Stitches

This may be due to any one of the following reasons:

The thread stand may not be properly adjusted. The thread stand must always be set so that each thread will pull off the spool or cone in a direct line with its threading point on the stand or machine so that the thread will not be obstructed by dragging or catching on the side of the spool or cone. The threads must always unwind freely from the spools or cones to ensure the satisfactory operation of the machine.

The needle may not be pushed up as far as it will go into the needle holder. When placing the needle in the needle holder be sure that the needle is striking the end of its seat in the holder, then securely tighten the set screw with the **small** screwdriver furnished for the purpose. Never use a large screwdriver on the needle set screw as it may damage the head of the screw so that it cannot be tightened sufficiently to hold the needle.

The needle may be blunt or bent. Roll the needle on its shank on the work clamp plate of the machine to determine whether it is straight.

The needle may be turned slightly so that the loop of needle thread would be cast sideways away from or towards the looper points. The needle must always be set into the holder with its eye and short groove with the slab above the eye facing directly toward the front end of the machine so that the loop will be cast at right angles to the travel of the loopers, with machine in stopping position.

The loop retainers (Z8 and A9, Fig. 15) may not be correctly set as instructed on pages 35, 36 and 37.

The throat plate (12, Fig. 4) may not be correctly set as instructed on page 37. The throat plate may be incorrectly set so that the needle comes into contact with the walls of the opening in the throat plate, causing the needle to be deflected away from or into the path of the loopers.

The throat plate may be set too low, allowing the material to be forced downwardly by the needle and then lifted by the needle, resulting in a poor cast of a loop. For heavy materials, the top of the throat plate should be set slightly below the top surface of the work clamp plates.

Improper spreading of the work clamps may cause the needle to strike or glance on the clamps and be deflected out of the path of the loopers or thread retainers, resulting in the skipping of stitches.