

SINGER
107W17

USE SINGER* OILS and LUBRICANTS

They insure freedom from lubricating trouble and give longer life to sewing equipment

The following are the correct lubricants for this machine:

TYPE B — MANUFACTURING MACHINE OIL, HEAVY GRADE

When an oil is desired which will produce a minimum of stain on fabrics, even after a long period of storage, use:

TYPE D — MANUFACTURING MACHINE OIL, HEAVY GRADE

OTHER SINGER LUBRICANTS

TYPE E — THREAD LUBRICANT

For lubricating the needle thread of sewing machines for stitching fabrics or leather where a thread lubricant is required.

TYPE F — MOTOR OIL

For oil lubricated motors and plain bearings in power tables and transmitters.

NOTE: All of the above oils are available in 1 quart, 1 gallon and 5 gallon cans.

GEAR LUBRICANT

This specially prepared grease is recommended for gear lubrication on manufacturing sewing machines.

BALL BEARING LUBRICANT

This pure grease is specially designed for the lubrication of ball bearings and ball thrust bearings of motors and electric transmitters, ball bearing hangers of power tables, etc. Furnished in 1 lb. and 4 lb. tins.

SERVICE MANUAL FOR SINGER* SEWING MACHINE

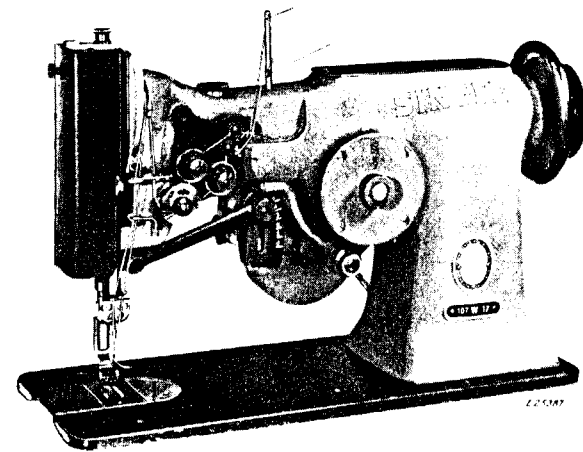

107w17

FOR ORNAMENTAL STITCHING

TWO NEEDLES

LOCK STITCH

THE SINGER MANUFACTURING COMPANY

*A Trade Mark of THE SINGER MANUFACTURING COMPANY

DESCRIPTION

Machine 107W17 (short arm) has cam controlled lateral movement of needle bar frame for ornamental stitching, cording on glove backs, etc. The machine has two needles and an adjustable needle holder, and makes two rows of stitching from a minimum of 1/32 inch to a maximum of 7/32 inch apart. Maximum vibration, 7/32 inch across outside lines of stitching. Maximum stitch length, 5 to the inch.

Cams can be furnished for various ornamental patterns. Unless otherwise ordered, machine is fitted with domino design cam.

SPEED

The maximum speed recommended is 2000 R.P.M. according to material being stitched. The machine should be run slower than the maximum speed at first until the parts which are in movable contact have become glazed by their action upon each other. When the machine is in operation, the machine pulley should always turn over towards the operator.

NEEDLES

Needles are of class 131X, have straight blade, diameter of shank .069 inch, are flatted on shank, and their positions are not interchangeable in the needle holder. The inside **right hand** needle is flat on the left side, the outside **left hand** needle is flat on the right side. The needles form the gauge between the seams.

The size of the needle to be used should be determined by the size of the thread which must pass freely through the eye of the needle. If rough or uneven thread is used, or if it passes with difficulty through the eye of the needle, the successful use of the machine will be interfered with.

Orders for needles must specify the QUANTITY required, the SIZE number, also the CLASS and VARIETY numbers separated by the letter x.

The best results will be obtained when using the needles sold by Singer Sewing Machine Company.

RELATIVE SIZES OF NEEDLES AND THREAD

Size Numbers of Needles	For Cloth Work	
	Cotton	Silk
12	70 to 100	OO to A
14	50 to 70	A, B
16	40 to 50	B, C
18	30 to 40	C, D

To make a smooth, even stitch with your sewing machine use good, firmly twisted and smoothly finished thread, that passes freely through the eye of the needle. No other needles will give as good results and satisfaction as those recommended above.

For ordinary work use the same size of thread on the bobbin as in the needle. Always use soft finished thread on the bobbin.

THREAD

Left twist thread should be used in the needle. Either right or left twist thread can be used for the bobbin.

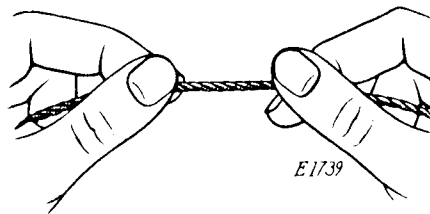

Fig. 2. How to Determine the Twist

Hold the thread as shown above. Turn the thread over toward you between the thumb and the forefinger of the right hand; if left twist, the strands will wind tighter; if right twist, the strands will unwind. Use soft finish thread of the same size for the needle and the bobbin.

TO OIL THE MACHINE

Use "TYPE B" or "TYPE D" OIL, sold by Singer Sewing Machine Company. For description of these oils, see inside front cover of this book.

When the machine is received from the factory, it should be thoroughly cleaned and oiled. Oil should be applied at each of

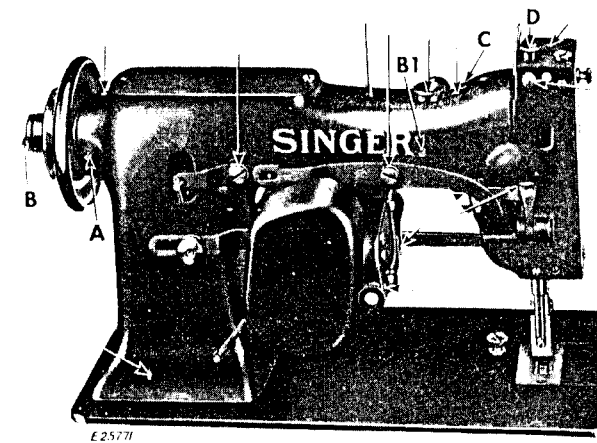

Fig. 3. Rear View of Machine, Showing Oiling Points Also Adjustments on the Machine

the places designated by arrows in Figs. 3, 4, 5 and 6, and all other places where there are parts in movable contact. When the machine is in continuous use, it should be oiled at least twice each day. Swing back the cover which is on top of the machine and oil the wicks and bearings thus uncovered, then replace the cover.

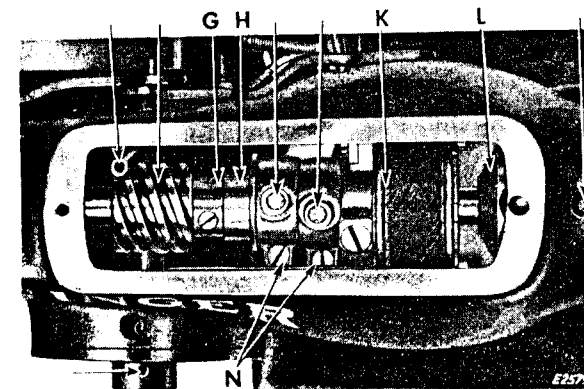

Fig. 4. Top View of Machine, Showing Oiling Points Inside of Arm

Remove the face plate and apply oil to the oil pad and all of the bearings which are thus uncovered, then replace the face plate.

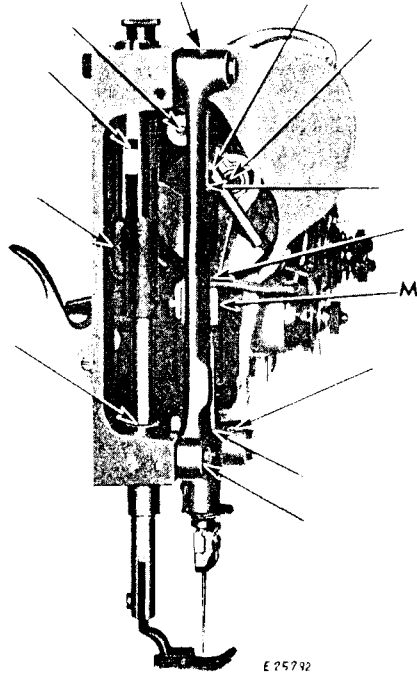

Fig. 5. End View of Machine, Showing Oiling Points

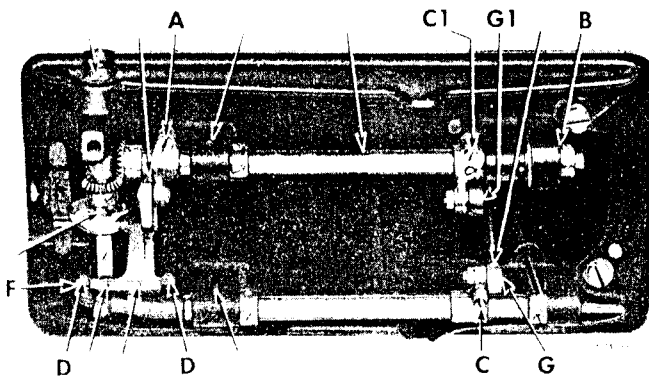

Fig. 6. Base View of Machine, Showing Oiling Points
Also Adjustments on the Machine

Remove the belt and turn the machine back on its hinges and apply oil at the places designated by arrows, as shown in **Fig. 6** and all other places where there are parts in movable contact.

Apply oil freely, about four times a day, to the wicking which is retained in the oil pocket at the back of the sewing hook. Also oil the sewing hook race each time a bobbin is replaced.

TO REMOVE THE BOBBIN

Draw out the slide in the bed of the machine; reach under the bed of the machine with the thumb and forefinger of the left hand,

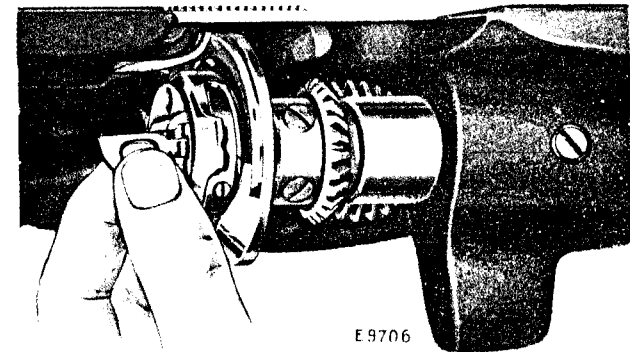

Fig. 7. Removing the Bobbin Case

open the bobbin case latch with the forefinger and lift out the bobbin case. See **Fig. 7**.

While the latch remains open the bobbin is retained in the bobbin case. Release the latch, turn the open end of the bobbin case downward and the bobbin will drop out.

TO WIND THE BOBBIN

(See Fig. 8)

Fasten the bobbin winder to the table with its driving pulley in front of the machine belt so that the pulley will drop away from the belt when sufficient thread has been wound upon the bobbin.

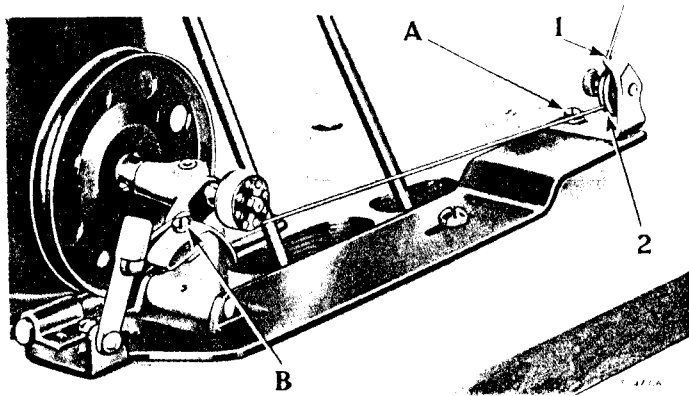

Fig. 8. Winding the Bobbin

Place the bobbin on the bobbin winder spindle and push it on as far as it will go.

Pass the thread down through the thread guide 1 in the tension bracket, around the back and between the tension discs 2. Then wind the end of the thread around the bobbin a few times, push the bobbin winder pulley over against the machine belt and start the machine.

When sufficient thread has been wound upon the bobbin, the bobbin winder will stop automatically.

If the thread does not wind evenly on the bobbin, loosen the screw A in the tension bracket and move the bracket to the right or left as may be required, then tighten the screw.

The amount of thread wound on the bobbin is regulated by the screw B. To wind more thread on the bobbin, turn the screw B inwardly. To wind less thread on the bobbin, turn the screw outwardly.

Bobbins can be wound while the machine is stitching.

TO THREAD THE BOBBIN CASE

Hold the bobbin between the thumb and forefinger of the right hand, the thread drawing on the bottom from the left toward the right, as shown in Fig. 9.

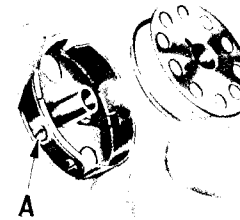

Fig. 9.

With the left hand, hold the bobbin case as shown in Fig. 9, the tension spring being at the front and place the bobbin into the bobbin case.

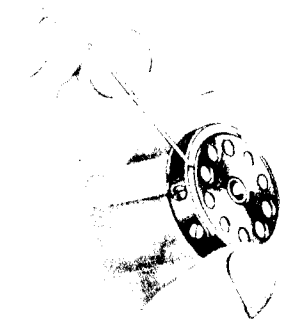

Fig. 10.

Then pull the thread into the slot in the edge of the bobbin case as shown in Fig. 10, and back under the tension spring into the slot at the end of the tension spring, as shown in Fig. 11.



Fig. 11.

TO REPLACE THE BOBBIN CASE

After threading, take the bobbin case by the latch, holding it between the thumb and forefinger of the left hand, place the

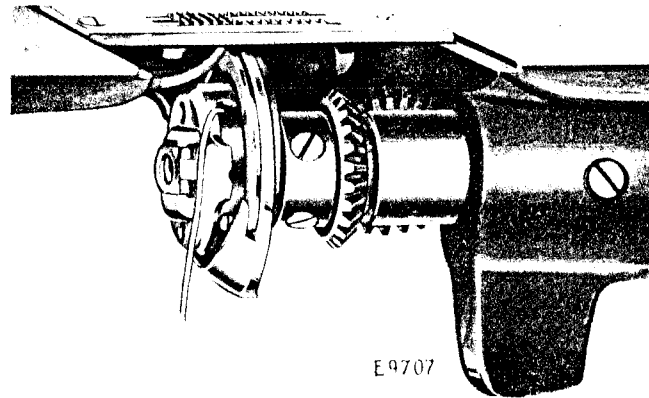

Fig. 12. Bobbin Case Threaded and Replaced

bobbin case on the center stud of the bobbin case base, release the latch and press the bobbin case back until the latch catches the groove near the end of the stud. See Fig. 12. Allow the thread to hang free and replace the slide in the bed of the machine.

TO SET THE NEEDLES

Turn the machine pulley over toward you until the needle bar moves up to its highest point and loosen the two lower set screws in the needle holders. Have the long groove of the needles toward you and put the needles up into the needle holders as far as they will go, then tighten the set screws.

UPPER THREADING OF THE MACHINE

(See Fig. 13)

To thread the outside needle or the one at the left, pass the thread from the thread unwinder through the top hole 1 in the pin on top of the machine, then through the hole 2 in the pin, through the thread guide 3 and upper thread retainer 4, over from right to left between the left tension discs 5, down under from right to left into the thread controller 6, pull the thread up against the controller spring 7 until it enters the hook in the controller disc, then pass the thread up through the thread guide 8 and from right to left through the upper hole in the thread take-up lever 9, down through the thread guide 8 again, through the left hole in the auxiliary thread take-up 10, down into the left wire thread guides 11 and 12 and from front to back through the eye of the left needle 13.

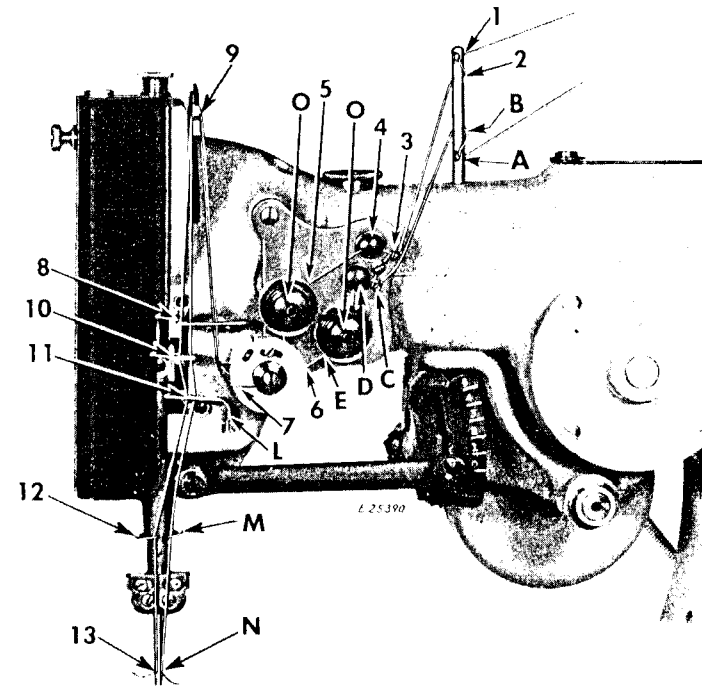

Fig. 13. Upper Threading of the Machine

To thread the inside needle or the one at the right, pass the thread from the unwinder through the hole A in the pin on top of the machine, then through the hole B in the pin, through the thread guide C and lower thread retainer D, under from right to left between the right tension discs E, down under from right to left into the thread controller 6, pull the thread up against the controller spring 7 until it enters the hook in the controller disc, then pass the thread up through the thread guide 8 and from right to left through the lower hole in the thread take-up lever 9, down through the thread guide 8 again, through the right hole in the auxiliary thread take-up 10, down into the right wire thread guides L and M and from front to back through the eye of the right or inside needle N.

TO PREPARE FOR SEWING

With the left hand hold the ends of the needle threads, leaving them slack from the hand to the needles. Turn the machine pulley over toward you until the needles move down and up again to their highest point, thus catching the bobbin thread; draw up the needle threads and the bobbin thread will come up with them through the needle hole in the throat plate. Lay the threads back under the presser foot.

TO COMMENCE SEWING

Place the material beneath the presser foot, lower the foot and commence to sew, turning the machine pulley over toward you.

TO REMOVE THE WORK

Stop the machine with the thread take-up lever at its highest point, raise the presser foot, draw the work back and cut the threads close to the goods.

TO REGULATE THE PRESSURE ON THE MATERIAL

The pressure on the material is regulated by the thumb screw **D**, Fig. 3 at the top of the machine. To increase the pressure, loosen the lock screw **E**, Fig. 3 at the rear of the machine, and turn the thumb screw **D** over to the right. To decrease the pressure, turn the thumb screw **D** over to the left. When the desired pressure on the material is obtained, tighten the lock screw **E**.

TO REGULATE THE TENSIONS

The tension on the needle threads is regulated by the thumb nuts **A**, Fig. 14 at the front of the tension discs. To increase the tension, turn these thumb nuts over to the right. To decrease the tension, turn these thumb nuts over to the left.

The tension on the bobbin thread is regulated by the screw **A**, Fig. 9 nearest the center of the bobbin case tension spring. To increase the tension, turn this screw over to the right. To decrease the tension, turn this screw over to the left.

TO REGULATE THE LENGTH OF STITCH

The length of the straightaway stitches is regulated by the thumb screw **B**, Fig. 3 at the right of the machine pulley.

There is a notch in the hub of the machine pulley and the number appearing in the notch shows the number of straightaway stitches to the inch that the machine is ready to make.

To increase the length of stitch, turn the thumb screw **B** over toward you. To decrease the length of stitch, turn this thumb screw over from you.

RECOMMENDATIONS FOR PROPER OPERATION

Follow instructions and oil machine regularly.

The machine pulley must always turn over toward the operator.

Do not run the machine with bobbin case only partly inserted.

Do not run the machine with the presser foot resting on the feed without cloth under the presser foot.

Do not run the machine when both bobbin case and needles are threaded unless there is material under the presser foot.

Do not try to help the machine by pulling the fabric lest you bend the needles. The machine feeds the work without assistance.

The slide over the bobbin case should be kept closed when the machine is in operation.

Do not press on the knee lifter lever while the machine is in operation, as this will prevent the work from feeding properly.

Occasionally remove the accumulation of lint from around the hook and from between the feed rows beneath the throat plate.

THREAD CONTROLLER

The function of the thread controller spring is to hold back the slack of the needle threads until the eye of each needle reaches the goods in its descent, as without this controlling action of the spring, the slack thread or silk (more especially silk) will sometimes be penetrated by the points of the needles as the needles are descending.

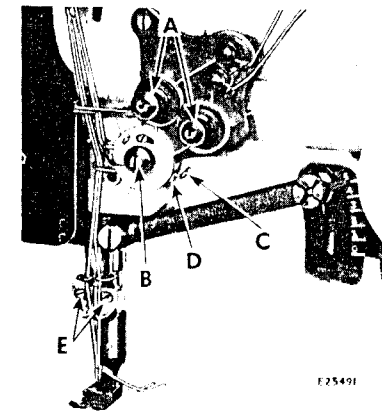

Fig. 14. Adjustment of Thread Controller

To change the thread controller stop for more controller action on the threads, loosen the set screw **C**, Fig. 14 and turn the thread controller spring stop to the right; for less action, turn the thread controller spring stop to the left, then securely tighten the set screw **C**.

It may be found advisable to increase the tension of the spring for coarse thread, or to lessen it for fine thread.

To increase the tension of the thread controller on the threads, loosen the tension stud set screw **D**, Fig. 14, located nearly under the tension stud, and turn the tension stud **B**, Fig. 14 slightly to the left with a screwdriver. To decrease the tension, turn stud **B** to the right and retighten the stud set screw **D**.

FEED

To take up lost motion of the feed driving and lifting connections, adjust screws **C**, **C1**, **G** and **G1**, **Fig. 6** and screws **N**, **Fig. 4**.

To prevent the feed dog from striking at either end of the slots in the throat plate, loosen screw **C**, **Fig. 6** and move the feed dog forward or backward until the longest stitch can be taken without the feed dog striking the throat plate, then retighten the screw **C**.

TO RAISE OR LOWER THE FEED DOG

Usually when at its highest position, the feed dog should show a full tooth above the throat plate.

Remove the throat plate; clean the lint and dirt from between the feed points and replace the throat plate; tip the machine back and turn the machine pulley toward you until the feed dog is at its highest position; loosen screw **A**, **Fig. 6** and raise or lower the feed dog as desired, then retighten the screw **A**. For adjustment to raise or lower the front or back of the feed dog, loosen the two screws **D**, **Fig. 6** and the eccentric stud **F**, **Fig. 6**, then tighten the two screws **D**.

When raising or lowering the feed dog be careful that its underside does not drop low enough to strike the hook.

TO SET THE NEEDLE BAR

See that the needles are up in the holders as far as they should go.

There are two lines $\frac{3}{32}$ inch apart across the needle bar about two inches above the lower end. When the needle bar is at its lowest position, the upper mark should be just visible at the end of the needle bar frame.

In case the needle bar is not correctly set, loosen the needle bar set screw **M**, **Fig. 5** and place the needle bar in the correct position as instructed above, then retighten the screw **M**.

To Set a Needle Bar Which Has no Mark—The hook and needles should be so timed that when the needle bar rises $\frac{3}{32}$ inch from its lowest position, the point of the sewing hook will be at the center of the right hand needle and about $\frac{1}{16}$ inch above the eye. For wider gauges, it may be necessary to slightly vary this measurement.

TO CHANGE THE DISTANCE BETWEEN THE NEEDLES

Loosen the two needle holder screws **E**, **Fig. 14** and move the needle holders an equal distance toward each other or away from each other as required, then tighten the two screws.

CAUTION: Upon completion of any of the above adjustments, make sure that the needles do not come into contact with the presser foot or throat plate.

TO TIME THE SEWING HOOK

Remove the throat plate and turn the machine pulley over toward you until the lower timing mark on the needle bar is just visible at the end of the needle bar frame; if the needles and hook are in correct time, the point of the hook will be at the center of the right hand needle and about $\frac{1}{16}$ inch above its eye.

Loosen the set screws in the hook driving belt pulley **B**, **Fig. 6** and turn the machine pulley over toward you until the needle bar moves down to its lowest position and upward until the lower timing mark on the needle bar is just visible at the end of the needle bar frame. Turn the sewing hook until the point is at the center of the right hand needle and about $\frac{1}{16}$ inch above its eye, then tighten the pulley screws, being careful to see that the end of the pulley hub is flush with the end of the shaft.

TO REMOVE THE HOOK

Remove bobbin case stop **F**, **Fig. 15**, then remove the hook spindle screw **A**, **Fig. 15** and withdraw the hook from its socket.

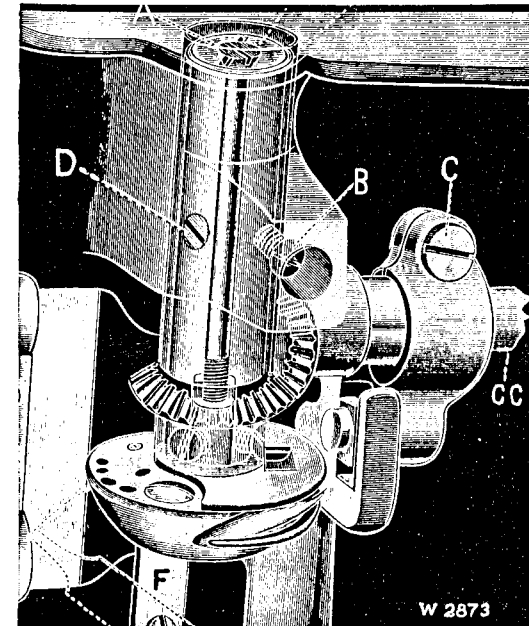

Fig. 15.

TO SET THE HOOK TO OR FROM THE NEEDLE

Loosen the two screws **B** and **D**, **Fig. 15** and move the hook to the desired position, then retighten the screws.

TO REMOVE THE BELT FROM WITHIN THE ARM

Slide arm shaft connection belt off the hook driving bevel pinion shaft belt pulley **B**, **Fig. 6**, remove the feed regulating spindle **B**, **Fig. 3** and machine pulley; loosen the arm shaft bushing (back) screw **A**, **Fig. 3** at the back of the arm and remove the bushing **L**, **Fig. 4**; lift the belt up through the arm cap hole as far as possible and draw it out through the space formerly occupied by the bushing.

In replacing the belt, see that the hook (sewing) and needle are in correct time before running the belt on the lower pulley **B**, **Fig. 6** and verify the correctness of the timing before commencing to sew.

To facilitate the replacing of the belt on the lower pulley, use belt replacer 244005 **A**, **Fig. 16**. Rest the replacer in the loop of the

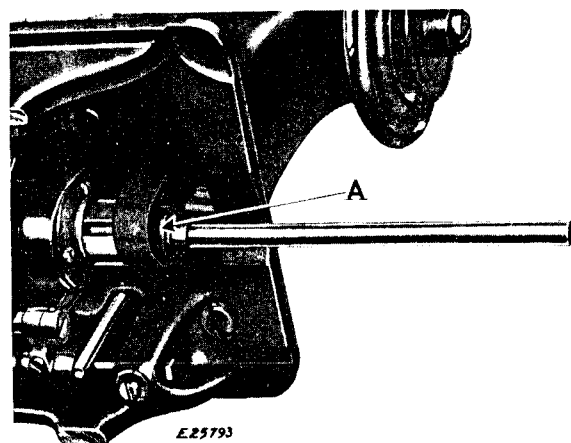

Fig. 16. Putting Belt on Lower Pulley with Belt Replacer 244005

belt and slide it over the hub of the pulley, as shown in **Fig. 16**, having the notches in the replacer engage the two set screws in the hub of the pulley. Turn the machine pulley toward you until the belt is fully over the pulley, then remove the replacer.

NOTE: As belt replacer 244005 will serve for several machines, it is not regularly furnished with the machine, and must be ordered separately.

TO REMOVE THE ARM SHAFT

Remove the screws **A**, **B**, **G** and **I**, **Fig. 17** and loosen the set screw in the belt pulley **K**, **Fig. 4**. Remove the position screw from the eccentric **H**, **Fig. 4** and loosen the set screw in the eccentric and the set screws in the gear **G**, **Fig. 4**. Remove the position screw from the needle bar crank and loosen the set screw. These screws are reached through the hole **C**, **Fig. 3** at the top of the arm. Draw the shaft out from the machine pulley end of the machine.

TO REPLACE THE ARM SHAFT AND CONNECTIONS

Return the shaft to its place through the belt pulley, the feed lifting eccentric, the shaft gear, friction washer and needle bar crank; return the position screws to the belt pulley, feed lifting eccentric and needle bar crank, and into their position holes in the shaft; tighten the set screw of each and replace the machine pulley, leaving the least possible end play to the shaft.

TO REMOVE THE ARM SHAFT BUSHING (FRONT)

After removing the needle bar crank position and set screws reached through hole **C**, **Fig. 3**, remove the bushing position screw **B1**, **Fig. 3** from the back of the arm, insert a brass rod through the arm cap hole and drive the bushing out.

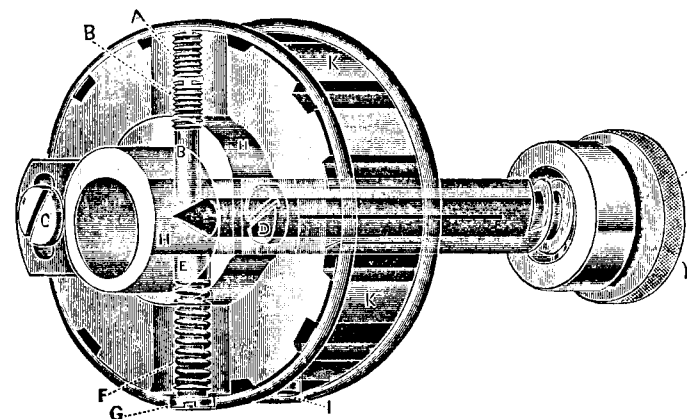

Fig. 17.

Transparent view through the arm shaft connection belt pulley and shaft showing the feed regulating spindle and feed driving eccentric regulating screw (**B**), which comes in contact with the cone of the spindle to gauge the length of stitch

TO REGULATE THE WIDTH OF VIBRATION

The width of zigzag movement of the needles is regulated by loosening the nut 1, Fig. 18 and raising or lowering the end of the needle bar frame pitman 2, Fig. 18 in the elongated slot of the segment lever 3, Fig. 18 as required.

TO SET NEEDLE BAR FRAME

To centralize the needles in the needle slot of the throat plate, loosen the nut 1, Fig. 18 and move stud to lowest position in the slot of segment lever 3, Fig. 18 and tighten it there. Loosen the set screw at the rear side of stud 4, Fig. 18 and turn the eccentric stud 5, Fig. 18 until the needles are central, then tighten set screw. To time the motion of the needle bar frame, turn the machine pulley until the arrow A, 5A, Fig. 19 on needle vibrator cam 1A, Fig. 19 is directly under the "V" slot 2A, Fig. 19. In this position it should be possible to move the stud up and down in the elongated slot of the segment lever 3, Fig. 18 without causing sidewise motion of the needles. If there is sidewise motion, loosen the clamping screw 4A, Fig. 19 and move the top of the segment lever 3, Fig. 18 to the right or left as required, to eliminate the sidewise motion. Tighten screw 4A, Fig. 19 making sure that there is no end play in the rock shaft 3A, Fig. 19 and that the rock shaft turns freely.

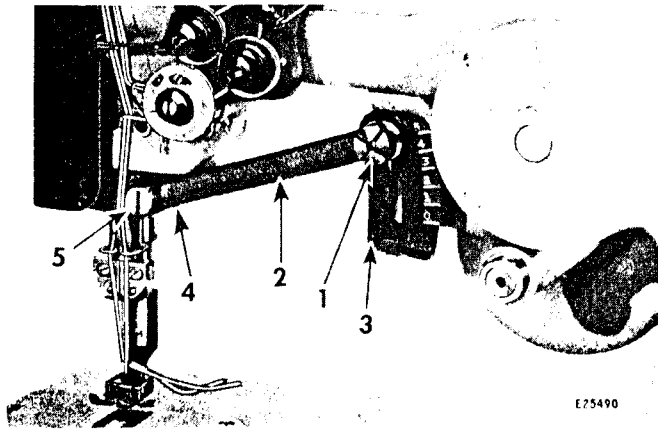

Fig. 18. Adjustment of Cam and Gears

To time the needle vibrator cam 1A, Fig. 19, turn the machine pulley until the needles are at the lowest point. Loosen the knurled screw 6, Fig. 19 (the squared portion of this screw makes possible the use of a wrench to accomplish this). Hold the machine pulley and turn the cam 1A, Fig. 19 until the arrow "B" 7, Fig. 19 is directly under the "V" slot 2A, Fig. 19, then tighten screw 6, Fig. 19.

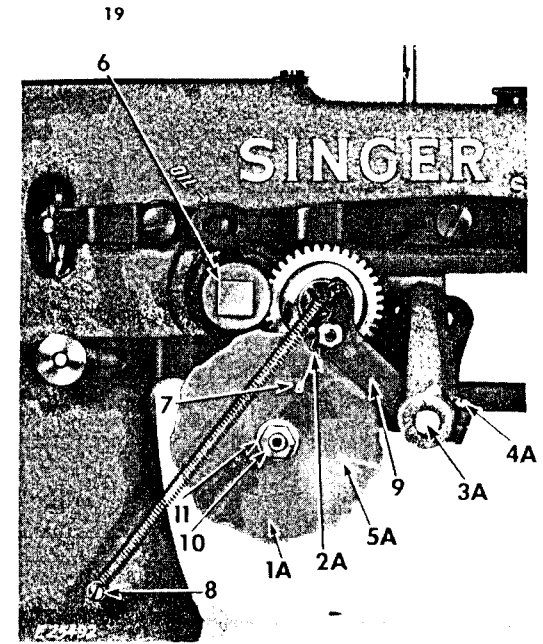

Fig. 19. Adjustment of Needle Vibrating Mechanism









To change needle vibrator cam, loosen needle bar frame pitman nut 1, Fig. 18 and lower end of needle bar frame pitman 2, Fig. 18 to lowest point of segment lever marked zero 3, Fig. 18, then tighten thumb nut. Turn machine pulley until arrow B, 7, Fig. 19 on needle vibrator cam 1A, Fig. 19 is in "V" slot 2A, Fig. 19. Unhook spring from stud 8, Fig. 19 and lift cam follower lever 9, Fig. 19. Remove nut 10, Fig. 19, thin washer 11, Fig. 19 and needle vibrator cam 1A, Fig. 19. When replacing the needle vibrator cam, keep needle bar frame pitman in same position as mentioned above, then replace needle vibrator cam with arrow B in "V" slot 2A, Fig. 19, replace thin washer, then securely tighten the nut and attach spring to the stud 8, Fig. 19. To adjust required vibration of the needles, loosen the nut 1, Fig. 18 and raise the end of the needle bar frame pitman 2, Fig. 18 in the elongated slot of the segment lever 3, Fig. 18. The amount of vibration is determined by the needle gauge. The maximum overall width of vibration, plus needle gauge is 7/32".

REC'D 6/4/56
IN FORM 19420 ✓

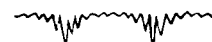
ORNAMENTAL STITCHING DESIGNS PRODUCED
WITH THE FOLLOWING CAMS

Changes in gauges can be made to produce different ornamental effects by changing the gauge of the needles in the needle holder.

STITCH DESIGN

No.		
242205—Arrowhead	_____	
242206—Domino	_____	
242208—Solid Scallop	_____	
242209—Icicle	_____	
242210—Banner	_____	
242211—Key	_____	
242212—Walls of Troy	_____	
242213—Solid Diamond	_____	
242214—Zigzag Point	_____	

NUMBER OF STITCHES PER REVOLUTION OF
PATTERN CAM IS 18

The machine will produce a single needle effect by using one needle, and replacing the other needles with stub needle shanks in order that the needle may be fastened in the needle holder. Gear 249675 with Cam 242167 will produce a scallop edge pattern as illustrated below.

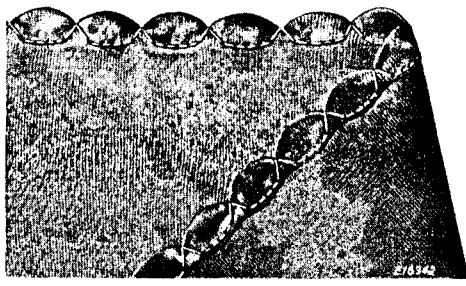

TO ALL WHOM IT MAY CONCERN:

The improper placing or renewal of the Trade Mark "SINGER" or any other of the Trade Marks of The Singer Manufacturing Company (all of which are duly Registered Trade Marks) on any machine that has been repaired, rebuilt, reconditioned, or altered in any way whatsoever outside a SINGER factory or an authorized SINGER agency is forbidden.



THE IMPORTANCE OF USING
SINGER* PARTS AND NEEDLES
IN **SINGER** MACHINES

The successful operation of **SINGER** machines can only be assured if **SINGER** parts and needles are used. Supplies are available at all **SINGER** Shops for the Manufacturing Trade, and mail orders will receive prompt attention.

SINGER Needles should be used
in SINGER Machines
These Needles and their Containers
are marked with the
Company's Trade Mark "SIMANCO.*" 1

Needles in Containers marked
"FOR SINGER MACHINES"
are NOT **SINGER** made needles. 2