

SINGER
145W103, W203, W303

2848w

INSTRUCTIONS
FOR USING AND ADJUSTING
SINGER SEWING MACHINES

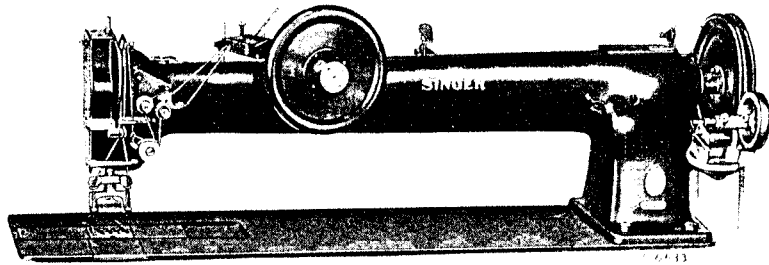

MACHINE 145w303

145w103, 145w203
and 145w303

THE SINGER MANUFACTURING CO.

DESCRIPTION

MACHINE 145w103 is a two-needle lock stitch machine with compound feed and high-lift alternating pressers. It is used for tents, awnings, furniture upholstery, leather coats, automobile work, etc. It has a high arm with a working space of 10 inches at the right of the needle bar. The machine is furnished in gauges from 1/4 to 2-1/2 inches.

MACHINE 145w203 is a long-arm machine with working space of 20 inches at the right of the needle bar and is used for stitching tarpaulins, tents, automobile door panels and for similar large work. Otherwise the machine is the same as Machine 145w103.

MACHINE 145w303 is the same as Machine 145w203 except that it has an extra long arm with a working space of 30 inches at the right of the needle bar. Has hand wheel at front of machine for convenience of operator.

Speed

The maximum speed recommended for these machines is 1500 revolutions per minute, when permitted by the nature of the material being sewn. The machines should be run slower than the maximum speed until the parts which are in movable contact have become glazed by their action on each other. When the machines are in operation, the balance wheel should turn over toward the operator.

Needles

Needles for Machines of Class 145w are of Class and Variety 7x23 for cloth, and 7x21 for stitching cardboard and fibre door panels. They are made in sizes 22, 23, 24, 25 and 27.

The size of the needle to be used should be determined by the size of the thread which must pass freely through the eye of the needle. If rough or uneven thread is used, or if it passes with difficulty through the eye of the needle, the successful use of the machine will be interfered with.

Orders for needles must specify the quantity required, the size number, also the class and variety numbers separated by the letter x.

The following is an example of an intelligible order:

"100 No. 24, 7x23 Needles."

The best results will be obtained when using the needles furnished by the Singer Sewing Machine Company.

To all whom it may concern:

The placing or renewal of the name "Singer" (Reg. U. S. Pat. Off.) or any of the trade marks of The Singer Manufacturing Company on any machine that has been repaired, rebuilt, reconditioned, or altered in any way whatsoever outside a Singer factory or an authorized Singer agency is forbidden.

THE IMPORTANCE OF USING GENUINE SINGER PARTS AND NEEDLES IN SINGER MACHINES

The successful operation of Singer machines can only be assured if genuine Singer parts and needles are used. Supplies are available at all Singer Shops for the Manufacturing Trade and mail orders will receive prompt attention.

Genuine Singer Needles should be used
in Singer Machines.
These Needles and their Containers
are marked with the
Company's Trade Mark "SIMANCO." 1

Needles in Containers marked
"For Singer Machines"
are not Singer made needles. 2

Oiling the Machine

When the machines are received from the factory, they should be thoroughly cleaned and oiled. When in continuous use, they should be oiled at least twice a day.

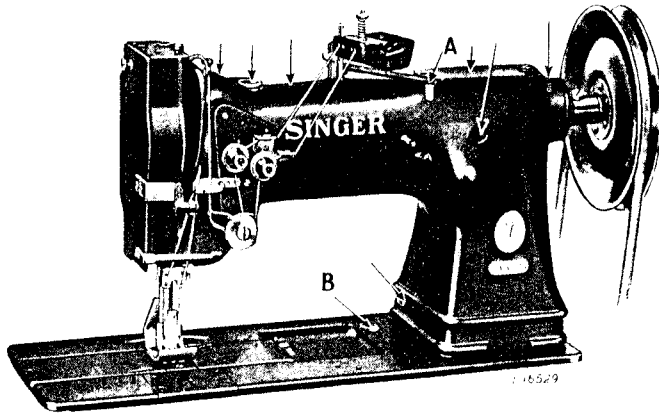

Fig. 2. Front View of Machine 145W103
Showing Oiling Points

Oil should be applied at each of the places designated by arrows in Figs. 2, 3, 4, 5 and 25.

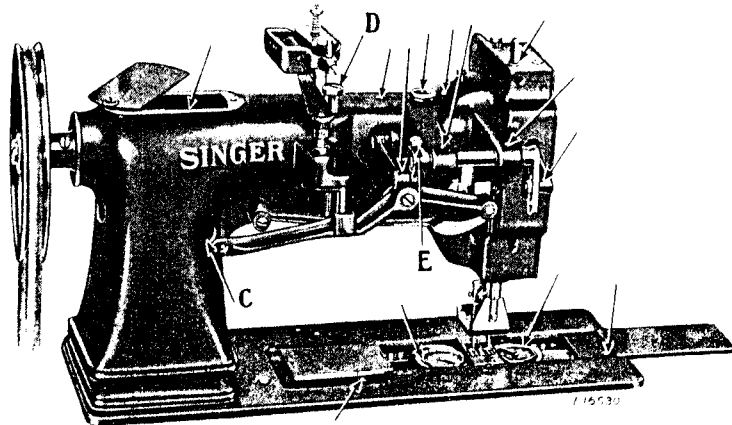

Fig. 3. Rear View of Machine
Showing Oiling Points and Adjustments

Loosen the thumb screw in the upper end of the face plate, turn the face plate upward and oil the wick and bearings which are thus uncovered, then turn down the face plate and tighten the thumb screw.

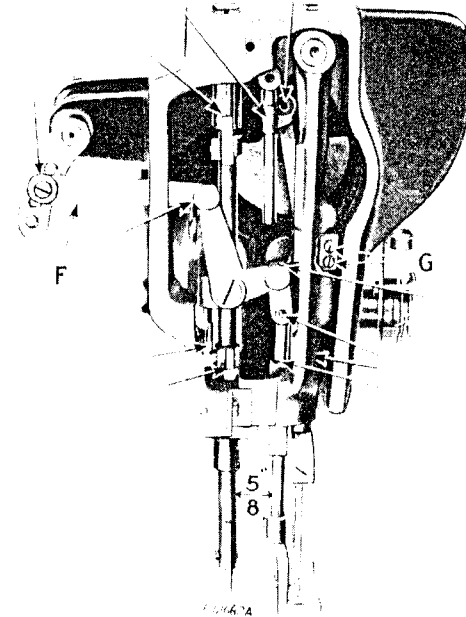

Fig. 4. End View of Machine Showing Oiling Points
Also Adjustments on the Machine

Apply a few drops of oil four times daily to the felt pad in the side wall of each bobbin case as illustrated in Fig. 10.

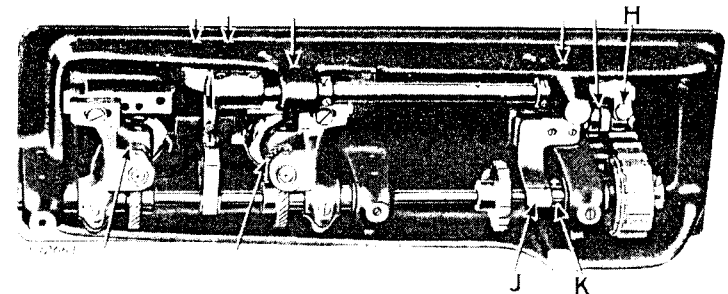

Fig. 5. Base of Machine Showing Oiling Points and Adjustments

Thread

Use left twist thread for the needles. Either left or right twist thread may be used for the bobbins.

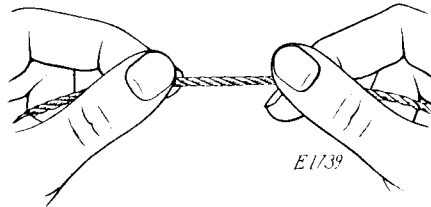

Fig. 6. How to Determine the Twist

Hold the thread as shown above. Turn the thread over toward you between the thumb and forefinger of the right hand; if left twist, the strands will wind tighter; if right twist, the strands will unwind.

To Set the Needles

Turn the balance wheel over toward you until the needle bar moves up to its highest position; loosen the set screws in the needle holder and put the needles up into the holder as far as they will go, with their long grooves facing each other and their eyes in line, then tighten the set screws.

To Remove the Bobbins

Draw back the slide plates in the bed of the machine and turn the balance wheel until the bobbin case openers (M, Fig. 7) move clear of the bobbins. With the forefinger or a screwdriver, raise the latches (L) to a vertical position and lift out the bobbins.

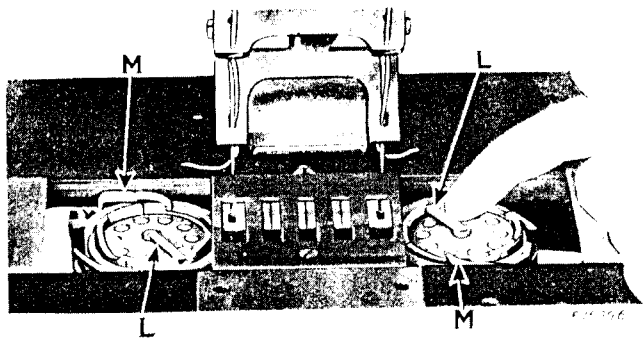

Fig. 7. Removing the Bobbin

To Wind the Bobbins on Machines 145w103 and 145w203

(See Fig. 8)

Fasten the bobbin winder to the table with its driving pulley in front of the machine belt, so that the pulley will drop away from the belt when sufficient thread has been wound upon the bobbin.

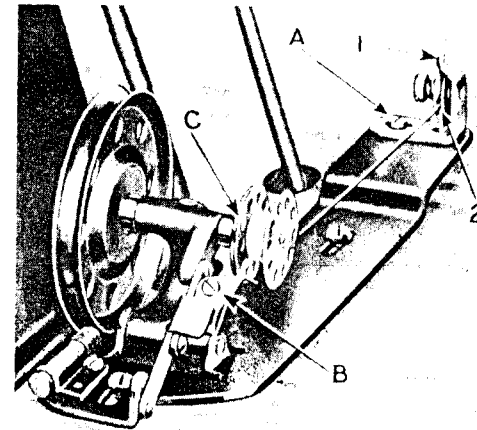

Fig. 8. Winding the Bobbin

Place the bobbin on the bobbin winder spindle and push it on as far as it will go, being sure that stud (C) enters a hole in the bobbin.

Pass the thread down through the thread guide (1) in the tension bracket, around the back and between the tension discs (2). Then wind the end of the thread around the bobbin a few times, push the bobbin winder pulley over against the machine belt and start the machine.

When sufficient thread has been wound upon the bobbin, the bobbin winder will stop automatically.

If the thread does not wind evenly on the bobbin, loosen the screw (A) in the tension bracket and move the bracket to the right or left as may be required, then tighten the screw.

The amount of thread wound on the bobbin is regulated by the screw (B). To wind more thread on the bobbin, turn the screw (B) inwardly. To wind less thread on the bobbin, turn the screw outwardly.

Bobbins can be wound while the machine is stitching.

To Wind the Bobbins on Machine 145w303

(See Fig. 9)

Place the bobbin on the bobbin winder spindle and push it up against the shoulder until it is in line with the bobbin winder latch.

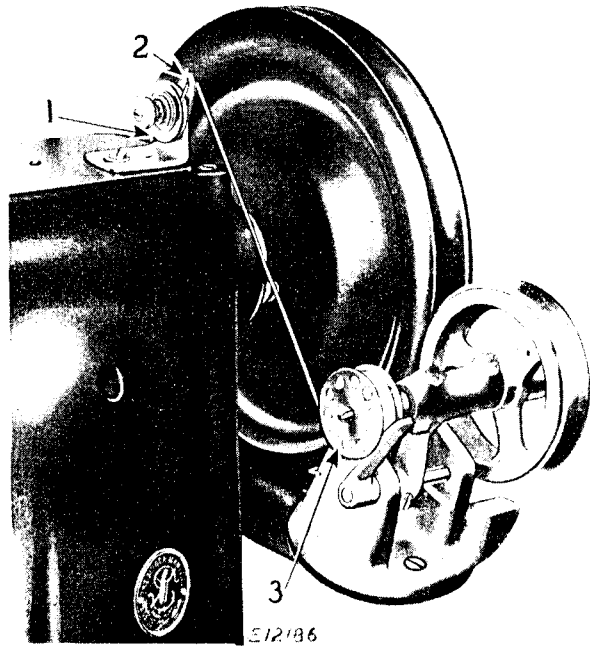

Fig. 9. Winding the Bobbin

Pass the thread from the unwinder, under and between the tension discs (1), through the eyelet (2), and wind the end of the thread around the bobbin (3) a few times. Push the bobbin winder pulley against the balance wheel and press the latch against the bobbin. When sufficient thread has been wound on the bobbin, the bobbin winder will stop automatically. Bobbins can be wound while the machine is stitching.

To Replace the Bobbins and Thread the Bobbin Cases

Hold each bobbin between the thumb and forefinger with the thread drawing on the bottom from left to right as shown in Fig. 10 and place

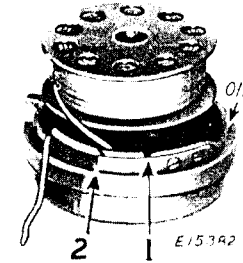

Fig. 10. Direction of Thread on Bobbin

it on the center stud of the bobbin case, then push down the latch (L, Fig. 11). Draw the thread into the slot (1, Fig. 10), under the tension spring and into slot (2) as shown in Figs. 10 and 11, leaving a loose end of thread about two inches long above the slide. When closing the slide plates, leave just enough space for the threads to pass through.

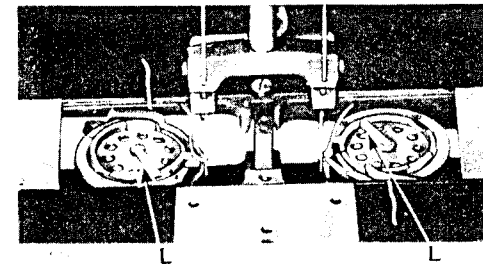

Fig. 11. Bobbin Cases Threaded

Threading the Needles

(See Fig. 12)

TO THREAD THE LEFT-HAND NEEDLE, pass the thread from the unwinder through one of the holes (1) in the thread oiler, and under the wire

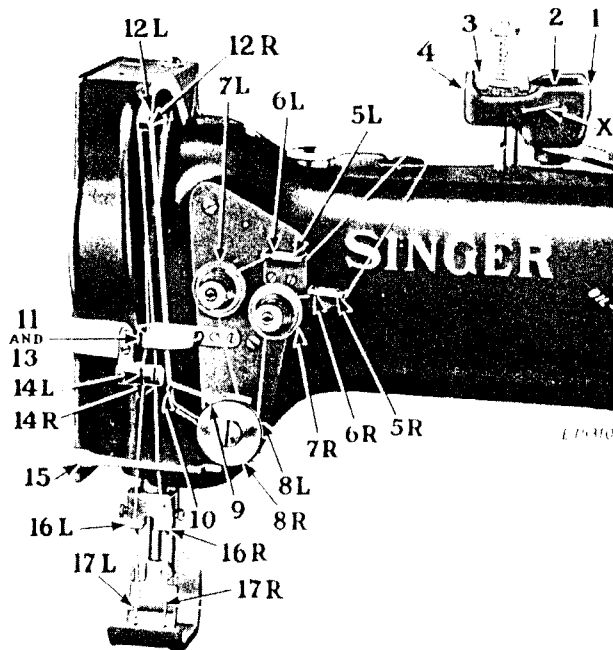

Fig. 12.

guide (2) (which may be raised by prying the end (x) out of its position hole with a screwdriver and turning it to the right), then under the oil pad (3) and out through one of the notches (4) in the thread oiler; upward through eyelet (5L) and downward through eyelet (6L) in the left thread guide, over between the left tension discs (7L), down around the rear thread controller disc (8L) and into the thread controller thread guide (9), into the thread take-up spring (10), up through the guide (11), from right to left through the eye (12L) in the take-up lever, down through the guide (13), into the left thread guide (14L) (used only for thread smaller than No. 12), back of the lower guide (15), into the left needle holder eyelet (16L) and from right to left through the eye (17L) of the left needle.

TO THREAD THE RIGHT-HAND NEEDLE, pass the thread from the unwinder through the thread oiler the same as for the left thread, then upward through eyelet (5R) and downward through eyelet (6R) in the right

thread guide, over between the right tension discs (7R), down around the front thread controller disc (8R) into the thread guide (9) and the take-up spring (10), up through guide (11), through the take-up lever eyelet (12R), down through guide (13), into the right thread guide (14R) (used only for thread smaller than No. 12), back of lower guide (15), into right needle holder eyelet (16R), and from left to right through the eye (17R) of the right needle.

To Raise or Lower the Presser Feet

The presser feet are raised by pressure on the foot treadle and may be locked in the raised position by moving the lever (A, Fig. 2) all the way to the left. A slight pressure on the treadle will automatically release the locking device.

To Prepare for Sewing

With the left hand hold the ends of the needle threads, leaving them slack from the hand to the needle. Turn the balance wheel over

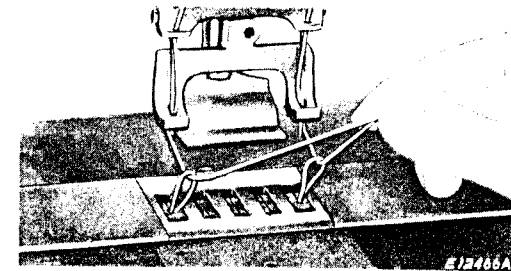

Fig. 13. Pulling Up the Bobbin Thread

toward you until the needles move down and up again to their highest point, thus catching the bobbin threads; draw up the needle threads and the bobbin threads will come up with them through the holes in the feed dog. Lay the threads back under the presser feet and close the slides.

To Commence Sewing

Place the material beneath the presser feet, lower the presser feet and commence to sew, turning the balance wheel over toward you.

To Remove the Work

Have the thread take-up lever at the highest point, raise the presser feet, draw the work back and cut the threads close to the goods. Lay the ends of the threads back under the presser feet.

Tensions

The needle and bobbin threads should be locked in the center of the thickness of the material, thus:



Fig. 14. Perfect Stitch

If the tension on the needle threads is too tight, or if that on the bobbin threads is too loose, the needle threads will lie straight along the upper surface of the material, thus:

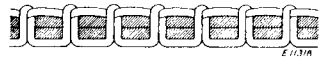

Fig. 15. Tight Needle Thread Tension

If the tension on the bobbin threads is too tight, or if that on the needle threads is too loose, the bobbin threads will lie straight along the under side of the material, thus:



Fig. 16. Loose Needle Thread Tension

To Regulate the Tensions

The tension on the needle threads is regulated by the two thumb nuts (N, Fig. 18) at the front of the tension discs on the front of the machine. To increase the tension, turn these thumb nuts over to the right. To decrease the tension, turn the thumb nuts over to the left.

The tension on the bobbin threads is regulated by means of the screw nearest the center of the tension spring on the outside of each bobbin case. To increase the tension, turn this screw over to the right. To decrease the tension, turn this screw over to the left.

To Regulate the Length of Stitch

The length of stitch is regulated by the feed eccentric (B, Fig. 17) located on the arm shaft.

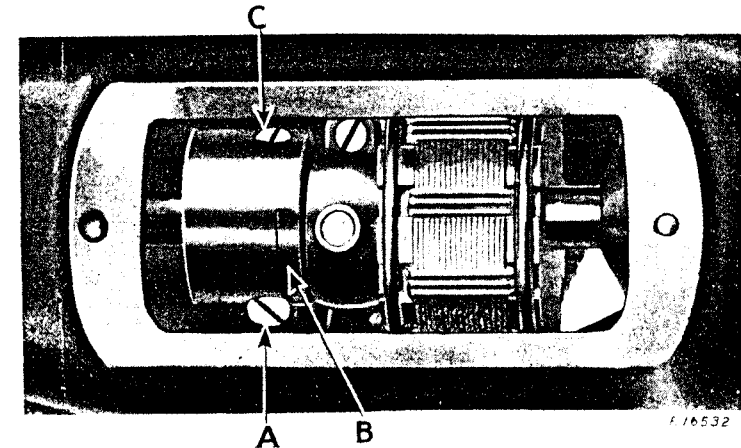

Fig. 17. Feed Eccentric. Arm Cap Removed.

To lengthen the stitch, loosen screw (C, Fig. 17) turn the feed regulating screw (A, Fig. 17) over toward the left. To shorten the stitch, turn this screw (A, Fig. 17) toward the right. When the desired length of stitch is obtained, securely tighten screw (C).

To Regulate the Pressure on Material

To increase the pressure of the presser feet on the material, turn the thumb screw (D, Fig. 3), at the back of the machine, downward. To decrease the pressure, turn this thumb screw upward.

The pressure on the material should only be sufficient to enable the feed to move the work along evenly.

INSTRUCTIONS
FOR
ADJUSTERS AND MACHINISTS

Thread Controller

The thread controller spring should be set so that it reaches its lowest point as the eyes of the needles nearly reach the goods in their descent.

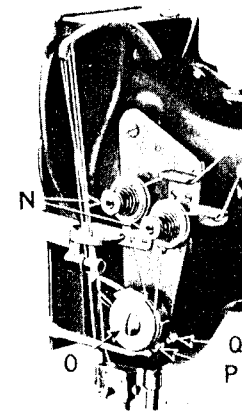

Fig. 18. Adjustment of Thread Controller

For more controller action on the thread, loosen the stop screw (P, Fig. 18) at the right of the controller and set the stop lower, and for less action set the stop higher.

To strengthen the action of the controller spring on the thread, loosen the spring stud screw (Q, Fig. 18) at the rear of the stop screw and turn the spring stud (O, Fig. 18) slightly to the left with a screwdriver, or to lighten its action turn to the right and retighten the spring stud screw.

To Set the Needle Bar

See that the needles are up in the holder as far as they will go. There are two lines across the needle bar about two inches above the lower end. When the needle bar is at its lowest position, the upper mark should be just visible at the end of the needle bar frame.

In case the needle bar is not correctly set, loosen the needle bar connecting stud pinch screws (G, Fig. 4) and place the needle bar in correct position as directed above, then retighten the screws (G).

To Set a Needle Bar Which Has No Mark

Adjust the feed eccentric (B, Fig. 17) so that there is no feed movement of the needle bar frame, then set the needle bar so that when it rises 1/8 inch from its lowest position, the points of the sewing hooks will be about 1/16 inch above the eyes of the needles.

Relative Positions of Vibrating Presser Bar and Lifting Presser Bar

The distance between the vibrating presser bar and lifting presser bar, after adjusting the feed eccentric (B, Fig. 17) so that there is no feed movement of the needle bar, should be 5/8 inch as shown in Fig. 4.

If the distance between the vibrating presser bar and the lifting presser bar is more or less, insert a screwdriver in the hole at (C, Fig. 3) at the rear of the machine and loosen the clamp screw which holds the needle bar rock frame rock shaft. While this screw is loose, the needle bar frame can be moved forward or backward to the required distance. A piece of metal of the correct width may be used to determine the correct distance. When making this adjustment be sure to see that the feed eccentric (B, Fig. 17) is set so that there is no feeding movement of the needle bar. When the adjustment has been made, securely tighten the clamp screw at C.

To Change the Amount of Lift of the Alternating Pressers

The height of lift of the pressers is adjustable by moving the link (F, Fig. 4) to any of the four holes in the rock shaft crank. The maximum lift is secured with the link in the bottom hole. The amount of lift should be regulated according to the thickness of the material being sewn. The feet should lift just high enough to clear the material.

To Adjust the Relative Height of Lift of the Vibrating and Lifting Pressers

As a rule, the vibrating and lifting pressers should lift an equal height, but some grades of work may require that they lift an unequal height. To change the relative lift of the presser feet, loosen the screw (E, Fig. 3) at the back of the machine and move the vibrating presser bar upward or downward as required, then securely tighten the screw (E).

To Time the Sewing Hook

Adjust the feed eccentric (B, Fig. 17) so that there is no feeding motion.

Remove the throat plate and turn the balance wheel over toward you until the lower mark across the needle bar is just visible at the end of the needle bar frame on the upward stroke of the needle bar. If the needle bar and sewing hooks are correctly timed, the points of the hooks will be at the centers of the needles and about 1/16 inch above the eyes.

In case the sewing hooks are not correctly timed, turn the balance wheel over toward you until the needle bar has descended to its lowest point and has risen until the lower timing mark across the needle bar is just visible at the end of the needle bar frame.

Loosen the two screws in the hub of each hook driving gear (T, Fig. 19) and tap this gear to the right or left on the hook driving shaft until the point of the hook is at the center of the needle. Tapping to the right gives an earlier hook timing, and to the left a later hook timing. Securely tighten the two set screws in each gear (T).

To Set the Sewing Hooks To or From the Needles

To prevent the points of the hooks from dividing the strands of the thread, they should run as close to the needles (within the scarf) as possible.

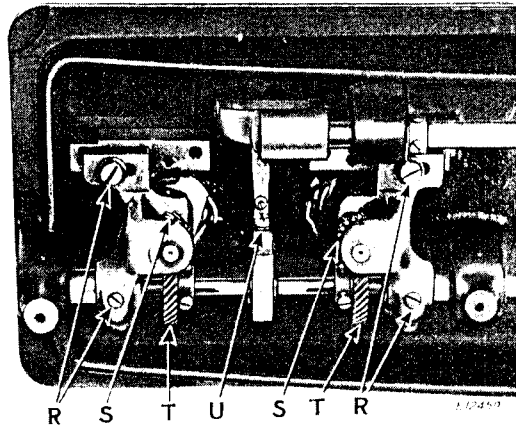

Fig. 19. Adjustment of Hook Saddles

Turn the balance wheel over toward you until the points of the sewing hooks are at the centers of the needles. Loosen the four screws (R, Fig. 19) underneath the bed of the machine and move the hook saddles to the right or left, as may be required, until the points of the hooks are as close to the needles as possible without striking them, then securely tighten the four screws (R).

The needle guard (Y, Fig. 21), which is attached to the side of each sewing hook, should be sprung until it prevents the needle from striking the hook in case the needle is deflected towards the hook.

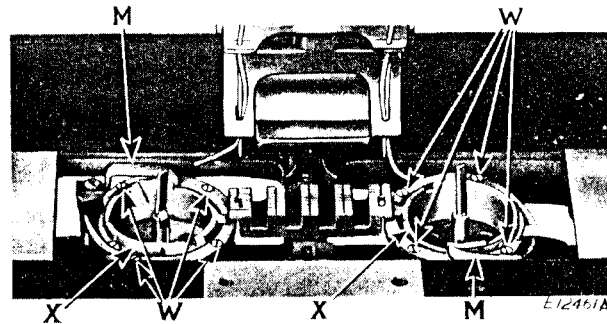

Fig. 20. Removing Bobbin Cases

To Remove the Bobbin Cases from the Sewing Hooks

Remove the bobbin case openers (M, Fig. 20); remove the four hook gib screws (W, Fig. 20) from each sewing hook, lift off the hook gibs (Z, Fig. 21) and remove the bobbin cases (X, Fig. 20).

To Remove the Sewing Hooks from the Machine

Remove the throat plate, feed dog and the bobbin case openers. Loosen the two screws in each hook shaft gear (S, Fig. 19) and lift out the sewing hooks.

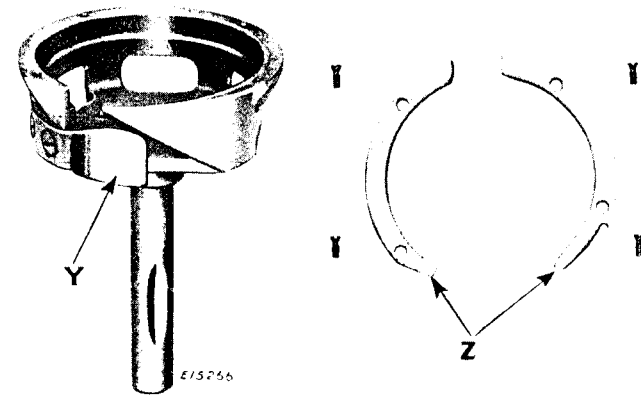

Fig. 21. Sewing Hook Removed from Machine
Showing Hook Gib and Needle Guard

To Raise or Lower the Feed Dog

Usually when the feed dog is at its highest position, it should show a full tooth above the throat plate.

Remove the throat plate; clean the lint and dust from between the feed points and replace the throat plate; tip the machine back and turn the balance wheel towards you until the feed dog is at its highest position; loosen screw (U, Fig. 19) in the feed lifting cam fork on the feed bar and raise or lower the feed dog, as may be required, and retighten the screw (U).

When raising or lowering the feed dog, be careful that its underside does not drop low enough to strike the sewing hooks.

The feed dog should be set so that the needles are centered in the needle holes. In case the needles do not enter the holes in the feed dog correctly, loosen the pinch screw (H, Fig. 5) and adjust the feed dog as required, then securely tighten the pinch screw (H).

To Remove the Needle Bar Rock Frame Rock Shaft

Remove the face plate and needle bar rock frame, then loosen the clamp screw at (C, Fig. 3) and draw out the rock shaft.

To Remove the Arm Shaft Connection Belt from within the Arm

Slide the connection belt off the lower belt pulley; remove the balance wheel; loosen the three screws in the arm shaft bushing near the balance wheel and remove the bushing; lift the belt up through the arm cap hole as far as possible and draw it out through the space normally occupied by the bushing.

Owing to the fact that the sewing hooks make two revolutions to one revolution of the hook driving shaft, and that the feed lifting eccentric is on the hook driving shaft, it is possible to have the sewing hooks correctly timed without having the feed correctly timed. To overcome this, the plate (J, Fig. 5) is attached to the underside of the bed of the machine. This plate is marked with an arrow at its lower end and directly alongside of the plate is the collar (K, Fig. 5) mounted on the hook shaft, which is also marked with an arrow. After replacing the belt over the upper pulley, replace the arm shaft bushing and securely fasten it in position by its three screws; replace the balance wheel. With the belt on the upper pulley, turn the balance wheel from you until the thread take-up lever is at its highest point. Then turn the hook shaft with the fingers until the two arrows, one on the plate (J) and the other on the collar (K), are directly in line. Now, without disturbing either the arm shaft or the hook shaft, slip the belt over the lower pulley. The feed will then be correctly timed with the needle bar.

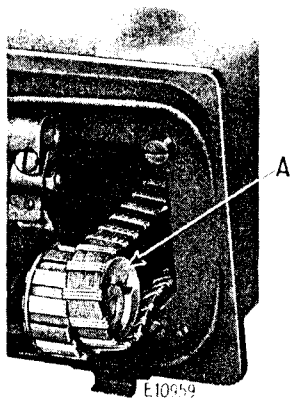

Fig. 22. Putting Belt on Lower Pulley with Belt Replacer 265058

To facilitate the replacing of the belt on the lower pulley, use belt replacer 265058 (A, Fig. 22). Rest the replacer in the loop of the belt and slide it over the hub of the pulley, as shown in Fig. 22, having the notches in the replacer engage the two set screws in the hub of the pulley. Catch the belt clips in the groove at the lower part of the pulley and turn the balance wheel toward you until the belt is fully over the pulley, assisting the belt clips from under the pulley rim with a screwdriver when necessary. Then remove the replacer.

NOTE: As belt replacer 265058 will serve for several machines it is not regularly furnished with the machine, and must be ordered separately.

To Re-engage the Safety Clutch

The hook driving shaft and the shafts of the sewing hooks are splined to prevent the hooks from getting out of time. The safety clutch located in the lower belt pulley prevents damage in the event of any unusual strain on the sewing hooks by releasing the locking lever in the pulley from the notch (D1, Fig. 24) in the collar of the hook driving shaft.

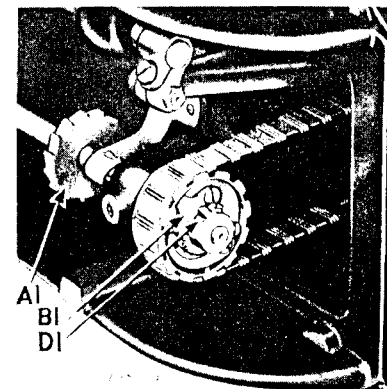
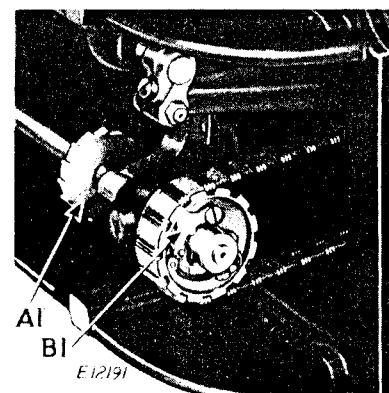

Fig. 23. Safety Clutch Disengaged Fig. 24. Operating Position

Draw back the bed slides, turn the balance wheel back and forth slightly, and remove the material that may be jamming the hooks. If necessary to re-engage the clutch, press down the lock stud (B, Fig. 2) near the base of the arm to engage the hook driving shaft lock ratchet (A1, Fig. 23) which will prevent the hook driving shaft from turning backward. Turn the balance wheel away from you until the locking lever (B1) snaps into the notch (D1) in the shaft collar as shown in Fig. 24. Release the lock stud and resume sewing.

To Adjust the Hand-Wheel Shaft on Machine 145w303

The hand-wheel shaft bushing (F1, Fig. 25) is eccentric and may be rotated to bring the hand-wheel gear (G1, Fig. 25) into proper engagement

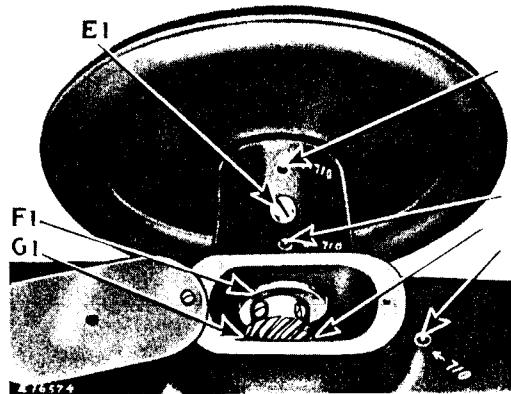

Fig. 25. Rear View, Showing Adjustments and Oiling Points
at Top of Long-Arm Machines

with the gear on the arm shaft. Loosen the bushing set screw (E1, Fig. 25) and the bushing (F1) may then be tapped around by means of a screw driver in holes in inner end of bushing until there is only a trace of backlash between the gears. Then tighten the set screw (E1).

Parts Required for Changing the Gauge of a Machine

The following Hook Saddle Bearings are used for different gauges:

Gauge	Hook Saddle Bearings	
	(Left)	(Right)
1/4 to 1-1/8	265272	265273
1-5/32 to 2-1/16	265274	265275
2-1/8 to 2-1/2	223680	223681

When changing the gauge from one of these ranges to another, a new pair of hook saddle bearings must be ordered. In addition to these, a new feed dog, throat plate, presser foot and needle holder will be required for each gauge.