

SINGER
136W104

USE ONLY **SINGER*** OILS and LUBRICANTS

*They insure freedom from lubricating trouble and
give longer life to sewing equipment*

The following are the correct lubricants for this machine:

TYPE B—MANUFACTURING MACHINE OIL, HEAVY GRADE

When a stainless oil is desired, use:

TYPE D—MANUFACTURING MACHINE OIL, STAINLESS,
HEAVY GRADE

GEAR LUBRICANT

This specially prepared grease is recommended for gear
lubrication on manufacturing sewing machines.

OTHER **SINGER** LUBRICANTS

TYPE E—STAINLESS THREAD LUBRICANT

For lubricating the needle thread of sewing machines for
stitching fabrics or leather where a stainless thread lubri-
cant is required.

TYPE F—MOTOR OIL

For oil lubricated motors and plain bearings in power
tables and transmitters.

NOTE: All of the above oils are available in 1 quart,
1 gallon and 5 gallon cans or in 55 gallon drums.

BALL BEARING LUBRICANT

This pure grease is specially designed for the lubrication
of ball bearings and ball thrust bearings of motors and
electric transmitters, ball bearing hangers of power tables,
etc. **Furnished in 1 lb. and 4 lb. tins.**

Copyright, U. S. A., 1914, 1922, 1925, 1926, 1927, 1929 and 1933,
by The Singer Manufacturing Company
All Rights Reserved for all Countries

2238w

INSTRUCTIONS FOR USING AND ADJUSTING **SINGER*** SEWING MACHINE

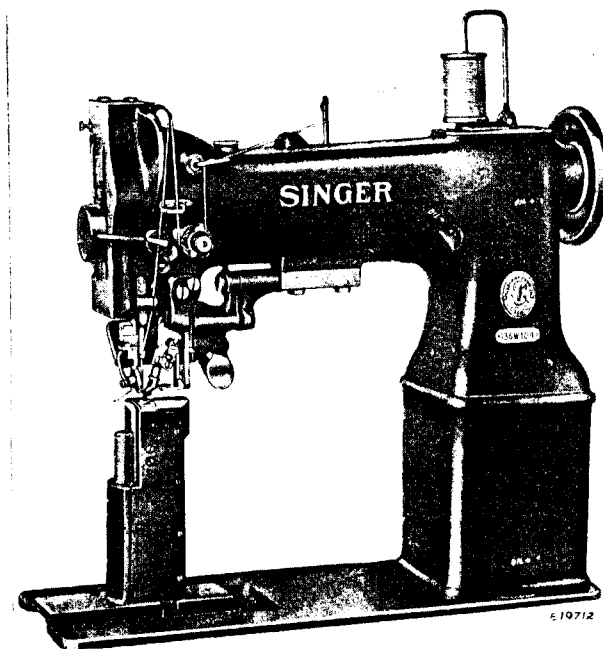

136w104

HORIZONTAL UNDEREDGE TRIMMER

POST BED

Fitted with Continuous Wheel Feed

For Leather Work

*A Trade Mark of

THE SINGER MANUFACTURING COMPANY

TO ALL WHOM IT MAY CONCERN:

The improper placing or renewal of the Trade Mark "SINGER" or any other of the Trade Marks of The Singer Manufacturing Company (all of which are duly Registered Trade Marks) on any machine that has been repaired, rebuilt, reconditioned, or altered in any way whatsoever outside a SINGER factory or an authorized SINGER agency is forbidden.

THE IMPORTANCE OF USING **SINGER*** PARTS AND NEEDLES IN **SINGER** MACHINES

The successful operation of SINGER machines can only be assured if SINGER parts and needles are used. Supplies are available at all SINGER Shops for the Manufacturing Trade, and mail orders will receive prompt attention.

SINGER Needles should be used
in SINGER Machines.
These Needles and their Containers
are marked with the
Company's Trade Mark "SIMANCO.*" 1

Needles in Containers marked
"FOR SINGER MACHINES"
are NOT **SINGER** made needles. 2

DESCRIPTION

Machine 136w104 has a continuously moving gear driven wheel feed which operates in unison with a needle feed. It is equipped with a horizontal underedge trimmer and is used for simultaneously stitching the edges and undertrimming the linings of shoes, sandals, slippers, etc. This machine has one needle and a gear driven rotary sewing hook and makes the lock stitch.

The machine is fitted with three pairs of feed gears which are instantly adjusted to make any one of three pre-determined lengths of stitches without removing any of the gears from the machine. See list of feed gears on page 11.

If desired, the machine can be limited to making but one or two lengths of stitches, as two spacing washers, which are quickly substituted for the feed driving gears (as instructed on page 13), are regularly furnished with each machine.

Speed

The maximum speed recommended for Machine 136w104 is 3000 stitches per minute. The machine should be run slower than the maximum speed at first, until the parts which are in movable contact have become glazed by their action upon each other. When the machine is in operation, the balance wheel should always turn over toward the operator.

Needles

Needles for Machine 136w104 are of Class and Variety 16x4 and are furnished in sizes 9, 10, 11, 13, 14, 16, 17 and 18.

The size of the needle to be used should be determined by the size of the thread, which must pass freely through the eye of the needle. If rough or uneven thread is used, or if it passes with difficulty through the eye of the needle, the successful use of the machine will be interfered with.

Orders for needles must specify the quantity required, the size number, also the class and variety numbers, separated by an x.

The following is an example of an intelligible order:

"100 No. 14, 16x4 Needles."

The best results will be obtained by using the needles furnished by the Singer Sewing Machine Company.

Thread

Left twist thread should be used in the needle. Either right or left twist can be used in the bobbin.

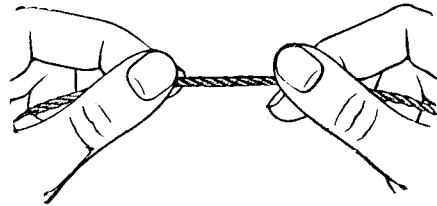

Fig. 2. How to Determine the Twist

Hold the thread as shown above. Turn the thread over toward you between the thumb and forefinger of the right hand; if left twist, the strands will wind tighter; if right twist, the strands will unwind.

To Remove the Bobbin

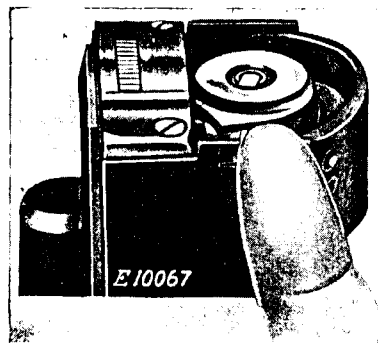

Fig. 3. Removing the Bobbin Case Cap

Draw out the slide plate on the top of the post. Turn the balance wheel over toward you until the needle bar moves up to its highest point. Place the thumb or finger under the projection on the side of the bobbin case cap as shown in Fig. 3, lift out the cap and remove the bobbin.

To Wind the Bobbin

(See Fig. 4)

Fasten the bobbin winder to the table with its driving pulley in front of the machine belt, so that the pulley will drop away from the belt when sufficient thread has been wound upon the bobbin.

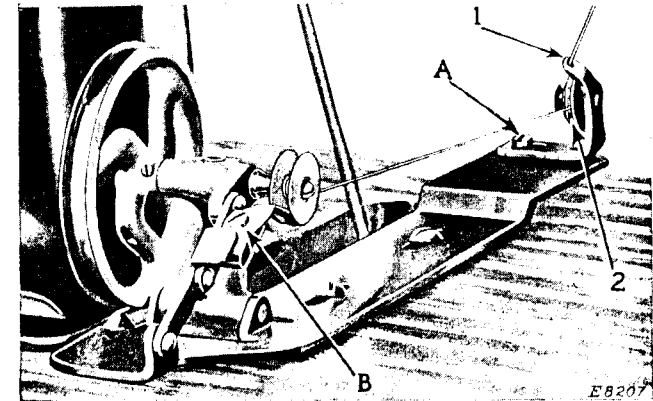

Fig. 4. Winding the Bobbin

Place the bobbin on the bobbin winder spindle and push it on as far as it will go.

Pass the thread down through the thread guide (1) in the tension bracket, around the back and between the tension discs (2). Then wind the end of the thread around the bobbin a few times, push the bobbin winder pulley over against the machine belt and start the machine.

When sufficient thread has been wound upon the bobbin, the bobbin winder will stop automatically.

If the thread does not wind evenly on the bobbin, loosen the screw (A) in the tension bracket and move the bracket to the right or left as may be required, then tighten the screw.

The amount of thread wound on the bobbin is regulated by the screw (B). To wind more thread on the bobbin, turn the screw (B) inwardly. To wind less thread on the bobbin, turn the screw outwardly.

Bobbins can be wound while the machine is stitching.

To Thread the Bobbin Case

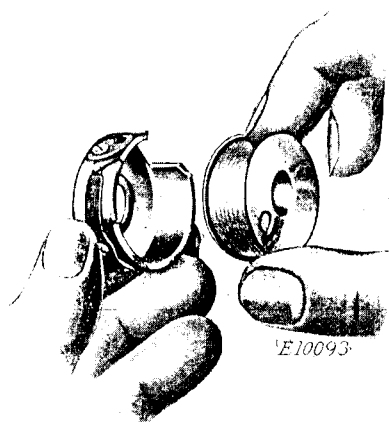

Fig. 5.

Hold the bobbin between the thumb and forefinger of the right hand, the thread drawing on the bottom from left to right, as shown in Fig. 5.

With the left hand hold the bobbin case cap as shown in Fig. 5 and place the bobbin into it.

Pull the thread into the slot (1, Fig. 6) in the edge of the bobbin case cap and under the tension spring. (To ensure the correct tension, draw the thread under the tension spring once or twice; this will remove any lint which may be lodged under the spring.)

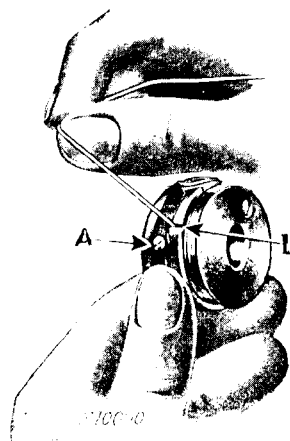

Fig. 6.



Fig. 7.

Then pull the thread out through the slot (2, Fig. 7)

into the slot (3, Fig. 8)

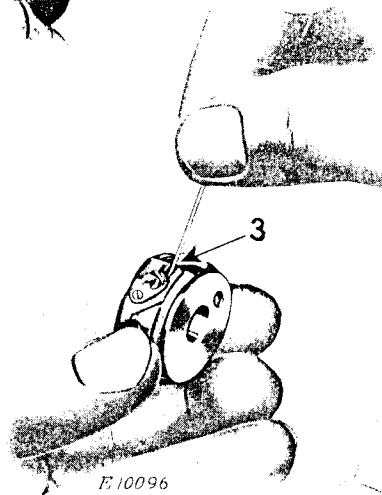

Fig. 8.

and back of the thread guide (4) as shown in Fig. 9.

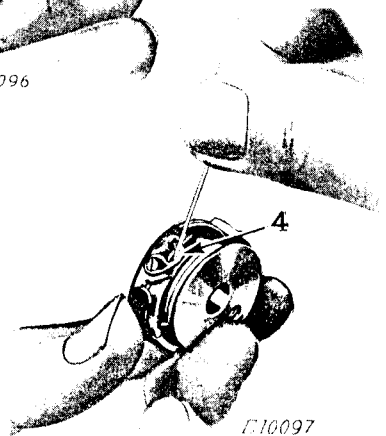

Fig. 9.

To Replace the Bobbin Case Cap

After threading, take the bobbin case cap in the right hand, holding the bobbin in the cap with the forefinger, and place it on

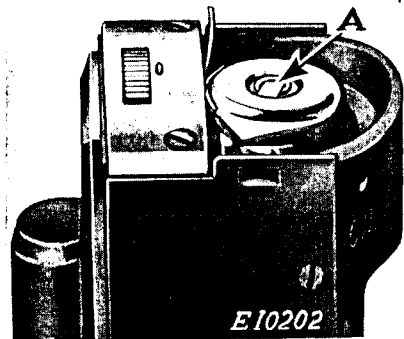

Fig. 10. Bobbin Case Cap Threaded and Replaced

the centre stud of the bobbin case base, then push down the latch (A, Fig. 10) and replace the slide plate, leaving a loose end of thread about two inches long above the slide.

To Set the Needle

Turn the balance wheel over toward you until the needle bar moves up to its highest point, loosen the set screw in the lower end of the needle bar and put the needle up into the needle bar as far as it will go, with the long groove of the needle toward the left and the eye directly in line with the arm of the machine, then tighten the set screw.

To Adjust the Thread Lubricator

To ensure satisfactory results, **"TYPE E" Stainless Thread Lubricant**, sold only by Singer Sewing Machine Company, should be used in the thread lubricator which is attached to the face plate.

When replenishing the lubricant supply, fill the reservoir (A, Fig. 11) to about $\frac{1}{8}$ inch below the filler hole (B, Fig. 11).

The amount of lubrication of the thread is controlled by raising or lowering the felt pad holder (12, Fig. 11) above or below the level of the lubricant. For more lubricant, lower the felt pad holder. For less lubricant, raise the felt pad holder.

Upper Threading

(See Fig. 11)

Pass the thread from the spool from back to front through the upper hole (1) in the pin on top of the machine, and from

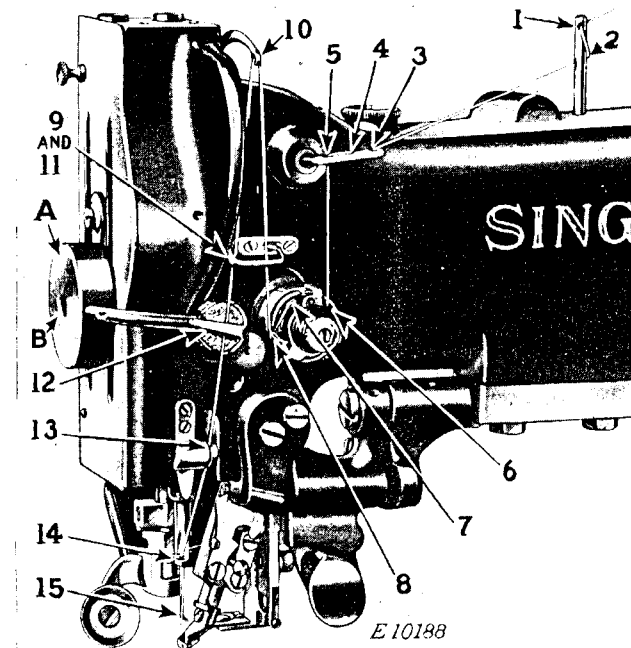

Fig. 11. Upper Threading

right to left through the lower hole (2) in the pin, down through the hole (3) in the thread guide at the front of the machine, up through the hole (4) in the thread guide and down through the hole (5) in the thread guide, down, under from right to left between the tension discs (6), pull the thread up under the thread take-up spring (8) until it enters the retaining fork (7), then pass the thread up through the thread guide (9), from right to left through the hole 10) in the end of the thread take-up lever, down through the thread guide (11), between the felt pad and felt pad retaining finger (12), into the thread retainer (13), down through the hole (14) at the lower end of the needle bar and from left to right through the eye of the needle (15). Draw about two inches of thread through the eye of the needle with which to commence sewing.

To Prepare for Sewing

With the left hand, hold the end of the needle thread, leaving it slack from the hand to the needle, turn the balance wheel over toward you until the needle moves down and up again to its highest point, thus catching the bobbin thread; draw up the needle thread and the bobbin thread will come with it through the hole in the throat plate. Lay the threads back under the roller presser.

To Commence Sewing

Place the material beneath the roller presser, lower the roller presser and commence to sew, turning the balance wheel over toward you.

To Remove the Work

Stop the machine with the thread take-up lever at its highest point, raise the roller presser, draw the work back and cut the threads close to the leather.

To Regulate the Pressure on the Material

The pressure on the material is regulated by the hexagon screw (B, Fig. 20) at the back of the machine, the screw acting on a flat spring. To increase the pressure, turn the screw downwardly. To decrease the pressure, turn the screw upwardly.

Tensions

The needle and bobbin threads should be locked in the centre of the thickness of the material, thus:



Fig. 12. Perfect Stitch

If the tension on the needle thread is too tight, or if that on the bobbin thread is too loose, the needle thread will lie straight along the upper surface of the material, thus:



Fig. 13. Tight Needle Thread Tension

If the tension on the bobbin thread is too tight, or if that on the needle thread is too loose, the bobbin thread will lie straight along the under side of the material, thus:



Fig. 14. Loose Needle Thread Tension

To Regulate the Tensions

The tension on the needle thread is regulated by the thumb nut (A, Fig. 19) at the front of the tension discs on the front of the machine. To increase the tension, turn this thumb nut over to the right. To decrease the tension, turn the thumb nut over to the left.

The tension on the bobbin thread is regulated by means of the screw (A, Fig. 6) nearest the centre of the tension spring on the outside of the bobbin case cap. To increase the tension, turn this screw over to the right. To decrease the tension, turn this screw over to the left.

Feed Gears for Machine 136w104 and Number of Stitches Produced Per Inch

Gear	Pinion	Stitches Per Inch
249020	249034	12
249021	249035	13
249022	249036	14
249023	249037	15
249024	249038	16
249025	249039	17
249026	249040	18
249027	249041	19
249028	249042	20
238641	238655	21
249029	249043	23
238642	238656	24
238605	238618	26
238606	238619	29
238607	238620	32

Machine 136w104 is regularly fitted to make 19, 21 and 23 stitches to the inch.

Any three sets of gears, as listed above, will be furnished in place of the regular gears, without additional charge, when so specified on the order.

Extra gears may be purchased.

Caution: When changing the feed gears, care must be taken to see that the gears to be used are correctly paired for each length of stitch according to the numbers given in the above list.

To Change the Length of Stitch

The three pairs of feed gears are located at the left underneath the bed of the machine, each pair of gears making a different length of stitch. The location of the knurled collar (B, Fig. 15) on its shaft determines which pair of gears is engaged. When the knurled collar (B) is at the outer end of its shaft, the outermost pair of gears (F, Fig. 16) is engaged. When the knurled collar (B) is in the central position on its shaft, the middle pair of gears is engaged. When the knurled collar (B) is set at

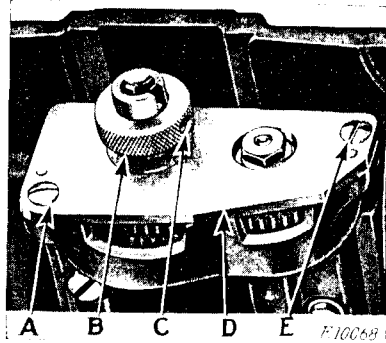

Fig. 15. Adjustment for Changing Length of Stitch

the innermost position on its shaft, the innermost pair of gears is engaged.

To change the length of stitch, raise the roller presser, then slide the knurled collar (B) to the desired position on the shaft and turn it in either direction until the engaging latch (G, Fig. 16) enters the notch in the gear.

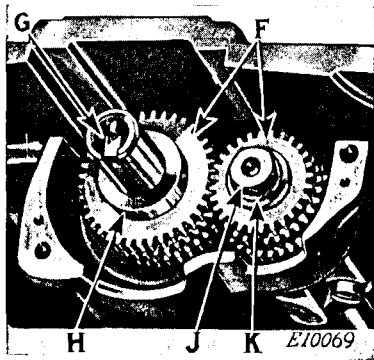

Fig. 16. Stitch Regulating Gears

To Limit the Machine to Making but One or Two Lengths of Stitches

When it is desired to limit the machine to making but one or two lengths of stitches, the spacing washers (L, Fig. 17) should be substituted for the feed driving pinions as instructed below:

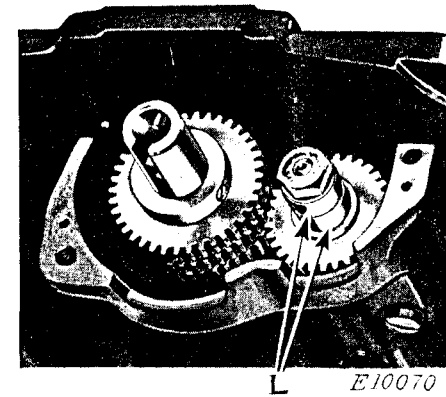

Fig. 17. Showing Spacing Washers in Position in Machine

Loosen the set screw (C, Fig. 15) and remove the knurled collar (B, Fig. 15). Take out the two screws (A and E, Fig. 15) and remove the cover plate (D, Fig. 15). Then loosen the set screw and remove the collar (H, Fig. 16), engaging latch (G, Fig. 16), nut (J, Fig. 16) and washer (K, Fig. 16).

As the largest of the three feed driving pinions is placed innermost on the shaft, it will be necessary to remove two of the feed driving gears in order to remove the three pinions. When removing the gears it will be noted that there are two separating washers on the shaft. These washers must be placed one between the first and second gears and one between the second and third gears, when the gears are replaced.

When replacing the gears, place the medium size gear on the shaft and the largest of the gears on the outside, at the same time replacing the pinion for making the desired length of stitch so that it meshes with its corresponding gear and setting the spacing washers (L, Fig. 17) opposite the gears which are to be disengaged. Then replace the engaging latch (G, Fig. 16), collar (H, Fig. 16) and washer (K, Fig. 16) and securely tighten the nut (J, Fig. 16). Replace the cover plate (D, Fig. 15) at the left of the gears, also replace the knurled collar (B, Fig. 15) and tighten the set screw (C, Fig. 15).

To Regulate the Amount of Travel of the Needle Bar

When the stitch regulating gears have been changed to produce a different length of stitch, the throw or amount of travel

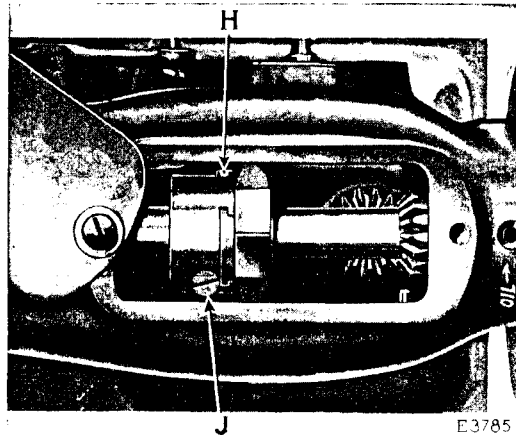

Fig. 18. Adjustment for Regulating Amount of Travel of Needle Bar

of the needle bar must also be changed, so that the needle will move forward in unison with the wheel feed for each stitch. When the variation between the three lengths of stitches the machine is set to make is not too great, the amount of travel of the needle bar should be adjusted to correspond with the middle length of stitch. This will automatically take care of the shorter and longer stitches which the machine will make.

Swing back the cover plate at the top of the machine and loosen the screw (H, Fig. 18) in the needle bar driving eccentric on the arm shaft. To increase the throw or amount of travel of the needle bar for a longer stitch, turn the large screw (J, Fig. 18) on the needle bar driving eccentric over to the left or upwardly. To decrease the throw of the needle bar for a shorter stitch, turn the large screw (J) over to the right or downwardly. When the required throw of the needle bar is obtained, firmly tighten the screw (H).

To Oil the Machine

To ensure easy running and prevent unnecessary wear of the parts which are in movable contact, the machine requires oiling, and when in continuous use, it should be oiled at least twice each day.

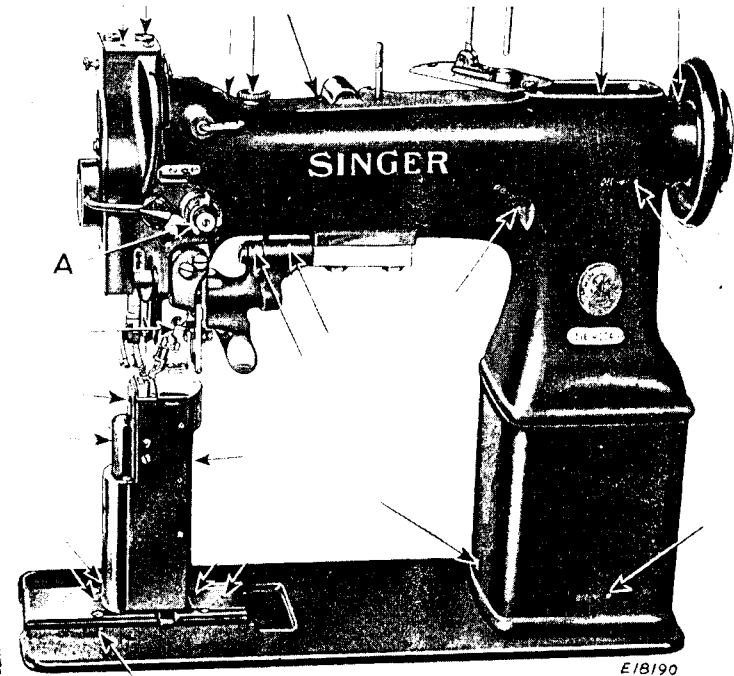

Fig. 19. Front View of Machine, Showing Oiling Points

The places where the machine should be oiled are indicated in Figs. 19, 20, 21 and 22, by arrows pointing to the oil holes and bearings.

The small felt pad on the side of the bobbin case should be kept wet with oil to lubricate the hook race.

Swing back the cover at the top of the machine and apply oil to the gears and needle bar driving eccentric thus uncovered.

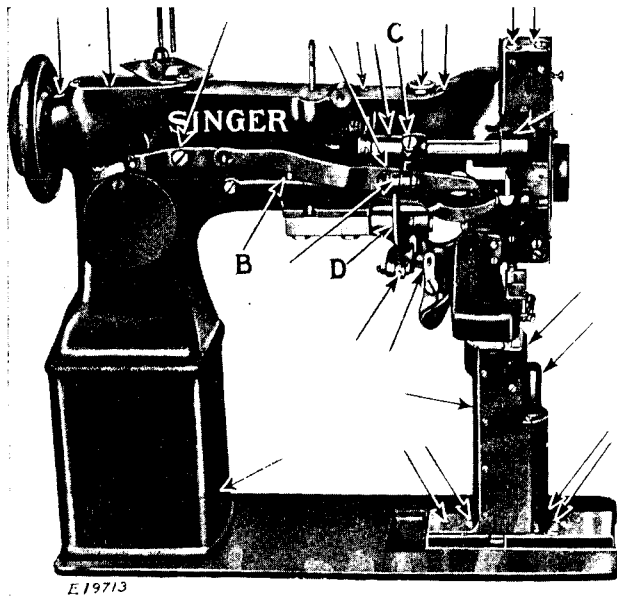

Fig. 20. Back View of Machine, Showing Oiling Points

Occasionally remove the cover (F, Fig. 21) and the screw (C, Fig. 21) of the gear cases on the underside of the bed of the

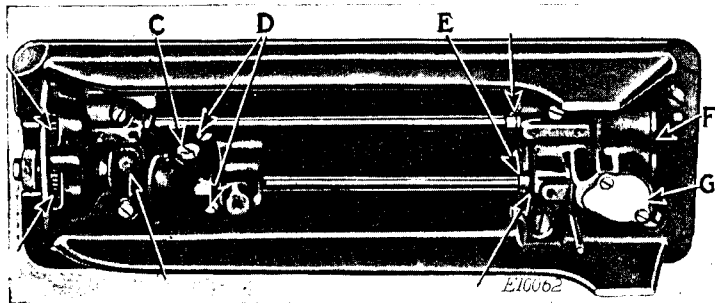

Fig. 21. Base View of Machine, Showing Oiling Points

machine and fill the gear cases with GEAR LUBRICANT, a grease which is sold only by SINGER SEWING MACHINE CO. for this purpose. When removing the cover (F) be careful not to damage the paper gasket under the cover. If this gasket is torn, the grease will leak out of the gear case when the cover is replaced.

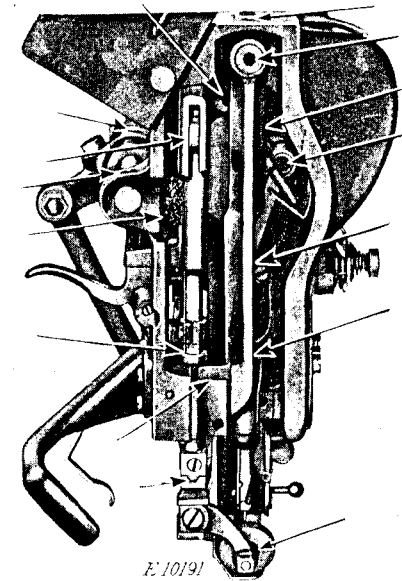

Fig. 22. End View of Machine, Showing Oiling Points

Loosen the thumb screw in the upper end of the face plate, pull out the lower end of the face plate over the position pin, swing up the plate and tighten the thumb screw. Oil the wicks and bearings which are thus uncovered, as shown in Fig. 22, then replace the face plate and tighten the thumb screw.

SINGER Needles should be used
in SINGER Machines.
These Needles and their Containers
are marked with the
Company's Trade Mark "SIMANCO." 1

Needles in Containers marked
"FOR SINGER MACHINES"
are NOT **SINGER** made needles. 2

To Adjust the Trimmer

The knife (C, Fig. 23) should be set so that its cutting edge presses against the cutting edge of the throat plate to ensure making a shear cut.

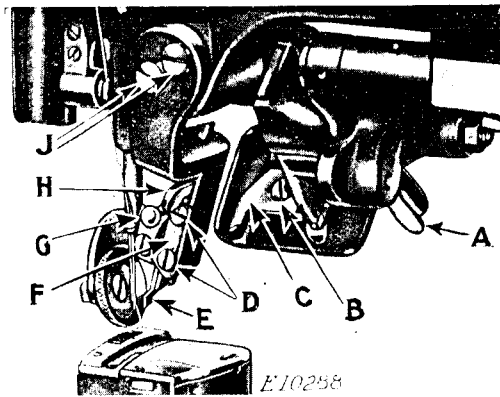

Fig. 23. Adjustments on Trimmer

A small adjustment of the height of the knife cutting edge can be made to accommodate the varying thicknesses of the leathers by turning the screw (M, Fig. 24) in or out, as required.

To move the knife toward you or from you, loosen the screw (L, Fig. 24) and move the knife bracket as required, then tighten the screw (L).

To throw the knife out of action, release the knife unlocking lever (A, Fig. 23) by pressing it between the thumb and forefinger of the right hand and move the knife driving arm as far back as it will go.

To throw the knife into action, move the knife driving arm forward until it snaps into position.

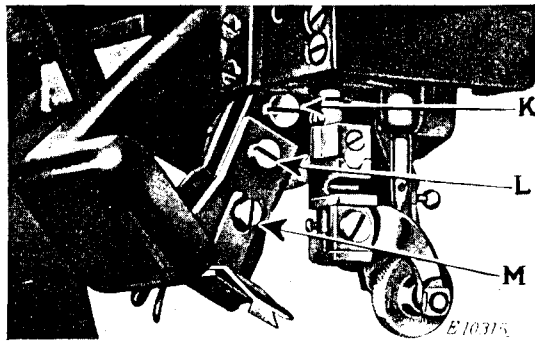

Fig. 24. Adjustments on Trimmer

The sidewise adjustment of the knife is made by loosening the screw (B, Fig. 23) and moving the knife to the right or left, as may be required, after which tighten the screw (B).

To adjust the knife to the correct height, loosen the screw (K, Fig. 24) and raise or lower the knife bracket holder as required, then tighten the screw (K).

To Time the Trimmer

The knife (C, Fig. 23) should be timed so that it is at its most forward position toward the operator and $\frac{1}{2}$ inch in front of the needle when the needle bar is at its lowest point. In case the knife is not correctly timed, loosen the screw (C, Fig. 20) at the back of the machine and raise or lower the knife driving connection (D, Fig. 20), as may be required, then tighten the screw (C).

To Adjust the Edge Guide

The edge guide (E, Fig. 23) can be adjusted so that the knife will trim the edge of the under ply of material from flush up to $\frac{1}{4}$ inch under the edge of the upper ply. To change the distance from the edge of the upper ply to the line of stitching, loosen the two screws (J, Fig. 23) and move the edge guide bracket to the right or left, as required, then tighten the two screws (J).

The edge guide should be adjusted to a height that will permit the knife to pass freely under it, the edge guide lightly touching the top of the knife. This adjustment is made by loosening the two screws (D, Fig. 23) and raising or lowering the edge guide position plate (F, Fig. 23), as required, then tighten the two screws (D).

If desired, the edges of the upper and under plies of material can be trimmed at the same time.

To disengage the edge guide (E, Fig. 23), raise the lifting pin (G, Fig. 23) until it locks. To re-engage the edge guide, push the latch (H, Fig. 23) to the left, which will release the guide

To Sharpen the Knife

When it is necessary to resharpen the knife (C, Fig. 23), loosen the screw (B, Fig. 23) and remove the knife from the knife holder. Knife Hone 259283 should be used to sharpen the knife. As this hone can be used for several machines, it should be ordered separately.

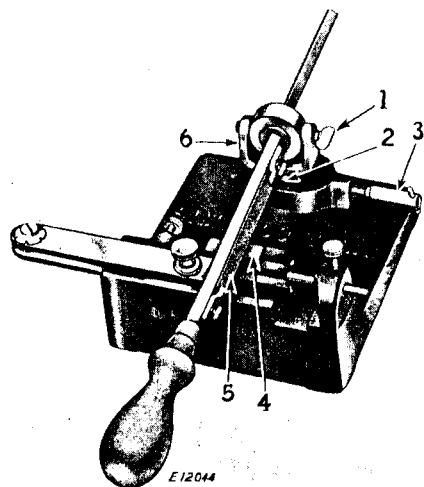

Fig. 25. Setting Hone at Proper Angle

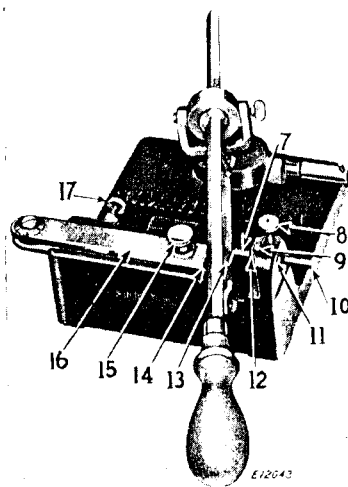

Fig. 26. Knife Hone 259283 with Knife in Position Ready to Sharpen

To set the hone at the proper angle, loosen the wing screw (1, Fig. 25), rest the stone (5, Fig. 25) flat on the leveling surface (4, Fig. 25), then tighten the wing screw (1).

Loosen the adjusting screw (3, Fig. 25) and set the yoke (6, Fig. 25) as high as it will go while the end of the adjusting screw (3, Fig. 25) remains on the flat of the yoke bushing (2, Fig. 25), then securely tighten the adjusting screw (3, Fig. 25).

For 30° cutting angle knives the upper knife stop pin (7, Fig. 26) should be set flush with the outside surface of the casting (11, Fig. 26) so that the pin extends to the left toward the knife holder slide. Larger cutting angles may be obtained by moving the knife stop pin (7, Fig. 26) to the right. When flush with the inside surface of the casting (12, Fig. 26), the cutting angle will be honed to 45°.

The knife stop pin (10, Fig. 26) not being used should be set as far as possible to the right, then tighten screws (8 and 9, Fig. 26).

Clamp knife into position on knife holder (14, Fig. 26) and tighten thumb screw (15, Fig. 26), slide holder (16, Fig. 26) into position on base until knife rests against the stop pin (7, Fig. 26), tighten knife holder set screw (17, Fig. 26), place hone (13) in position as illustrated in Fig. 26 and proceed to hone knife. Care should be taken not to press down too heavily on the knife.

INSTRUCTIONS FOR ADJUSTERS AND MACHINISTS

Thread Controller

The function of the thread controller spring is to hold back the slack of the needle thread until the eye of the needle nearly reaches the goods in its descent, as without this controlling action of the spring, the slack thread or silk (more especially silk) will sometimes be penetrated by the point of the needle as the needle is descending.

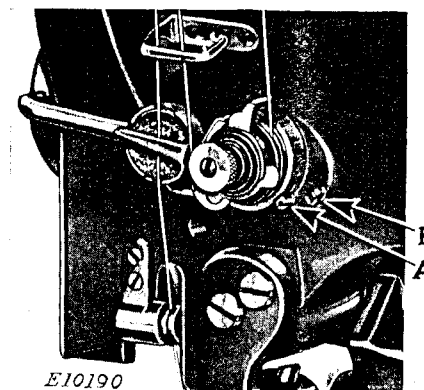

Fig. 27. Adjustments on Thread Controller

For more controller action on the thread, loosen the stop screw (A, Fig. 27) at the right of the tension and set the stop lower, and for less action set the stop higher, then tighten the stop screw (A).

To strengthen the action of the controller spring on the thread, loosen the tension stud screw (B, Fig. 27) at the right of the stop screw and turn the tension stud slightly to the left with a screwdriver, or to lighten its action turn to the right and tighten the tension stud screw (B).

To Set the Needle Bar

See that the needle is up in the bar as far as it will go. There are two lines across the needle bar about two inches above the lower end. When the needle bar is at its lowest position, the upper mark should just be visible at the end of the needle bar frame.

In case the needle bar is not set at the correct height, loosen the needle bar connecting stud pinch screw and place the needle bar in the correct position as instructed above, then tighten the screw.

To Set a Needle Bar which has no Mark. Set the needle bar so that when it rises $\frac{3}{8}$ inch from its lowest position, the point of the sewing hook will be at the centre of the needle and about $\frac{1}{16}$ inch above the eye.

To Change the Forward and Backward Position of the Needle Bar. Raise the round cover plate at the back of the machine and loosen the large screw thus brought to view. While this screw is loose, the needle bar can be moved forward or backward as required, to bring the needle in the desired position in the throat plate needle hole, after which securely tighten the large screw and replace the cover plate.

To Time the Sewing Hook

Remove the throat plate and turn the balance wheel over toward you until the lower mark across the needle bar is just visible at the end of the needle bar frame on the upward stroke of the needle bar. If the needle bar and sewing hook are correctly timed, the point of the hook will be at the centre of the needle and about $\frac{1}{16}$ inch above the eye.

In case the sewing hook is not correctly timed, remove the screw (C, Fig. 21) and loosen the two set screws in the hook driving gear thus uncovered, then turn the balance wheel over toward you until the needle bar has descended to its lowest point and has risen until the lower timing mark across the needle bar is just visible at the end of the needle bar frame. Now turn the sewing hook until the point of the hook is at the centre of the needle, after which securely tighten the two set screws in the hook driving gear and replace the screw (C).

To Set the Sewing Hook to or from the Needle

To prevent the point of the sewing hook from dividing the strands of the thread, it should run as close to the needle (within the scarf) as possible.

Remove the gear case cover (G, Fig. 21) and loosen the two screws in the hook shaft spiral driving gear thus uncovered, also loosen the screws in the collar (E, Fig. 21), then loosen the two screws (D, Fig. 21) and move the hook saddle toward or away from the needle, as required, after which securely tighten the two screws (D, Fig. 21), then move the collar (E, Fig. 21) over against the bushing and tighten its set screws. Tighten the two screws in the hook shaft spiral driving gear and at the same time hold the shaft to the right and the spiral gear to the left to eliminate any end play in the hook driving shaft.

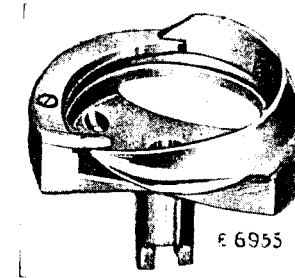

Fig. 28

To Remove the Sewing Hook from the Machine

Remove the hook gib screw and swing back the gib to allow the base of the bobbin case to be taken out, after which remove the screw from the centre of the hook. Tapping the hook slightly on the bottom of its rim will force it from its socket. Do not try to pry it out, as prying may bend the shank of the hook. In replacing the hook, be sure that the prongs of the shank properly enter the slot at the bottom of the socket, otherwise the hook will be out of time.

Needle Guard

The function of the hook washer (which is attached to the bottom of the sewing hook) is to prevent the point of the hook from striking the needle, if, when passing through the material, the needle is deflected towards the hook.

The upright portion of the hook washer should be sprung with a screwdriver or other instrument until it prevents the hook point from striking the needle. It should not, however, be sprung outwardly enough to deflect the needle from its normal path.

To Remove the Needle Bar Rock Frame Rock Shaft

Remove the face plate and needle bar rock frame, then raise the round cover plate at the back of the machine and loosen the large screw thus brought to view. The needle bar rock frame rock shaft can then be withdrawn from the machine.

To Raise or Lower the Feed Wheel

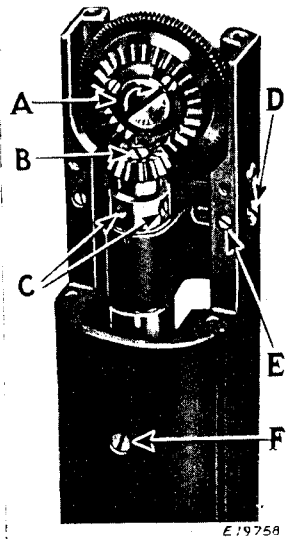

Fig. 29

The height of the feed wheel is regulated by adjusting the eccentric stud (D, Fig. 29). To raise or lower the feed wheel, loosen the set screws (E and F, Fig. 29) and turn the eccentric stud (D, Fig. 29) to right or left until the feed wheel is at the desired height, then securely tighten the set screws (E and F).

The feed wheel should be set so that slightly less than the full depth of the teeth project through the feed wheel slot in the throat plate.

To Remove Feed Wheel

Remove feed wheel cover and throat plate. Loosen the two set screws (C, Fig. 29) in the pinion gear, then remove the screw studs (A and B, Fig. 29), the screw (A) being right hand and the screw (B) left hand. The pinion and wheel feed may then be removed.

When replacing the pinion gear, be sure that the thrust washer is under it before inserting the screw stud (B). After stud (B) is tightened, turn the pinion until one of the set screws (C) is opposite the flat on the stud, and securely tighten both set screws.

SINGER Needles should be used
in SINGER Machines.
These Needles and their Containers
are marked with the
Company's Trade Mark "SIMANCO.*" 1

Needles in Containers marked
"FOR SINGER MACHINES"
are NOT **SINGER** made needles. 2