

USE SINGER OILS and LUBRICANTS

They insure freedom from lubricating trouble and give longer life to sewing equipment.

The following are the correct lubricants for this machine:

TYPE B — MANUFACTURING MACHINE OIL, HEAVY GRADE

When an oil is desired which will produce a minimum of stain on fabrics, even after a long period of storage, use:

TYPE D — MANUFACTURING MACHINE OIL, HEAVY GRADE

OTHER SINGER LUBRICANTS

TYPE E — THREAD LUBRICANT

For lubricating the needle thread of sewing machines for silitching fabrics or leather where a thread lubricant is required.

TYPE F — MOTOR OIL

For oil lubricated motors and plain bearings in power tables and transmitters.

NOTE: All of the above oils are available in 1 quart, 1 gallon and 5 gallon cans.

GEAR LUBRICANT

This specially prepared grease is recommended for gear lubrication on manufacturing sewing machines.

BALL BEARING LUBRICANT

This pure grease is specially designed for the lubrication of ball bearings and ball thrust bearings of motors and electric transmitters, ball bearing hangers of power tables, etc. Furnished in 1 lb. and 4 lb. tins.

INSTRUCTIONS FOR USING **SINGER** SEWING MACHINES OF **CLASS 7**

TWO NEEDLES

LOCK STITCH

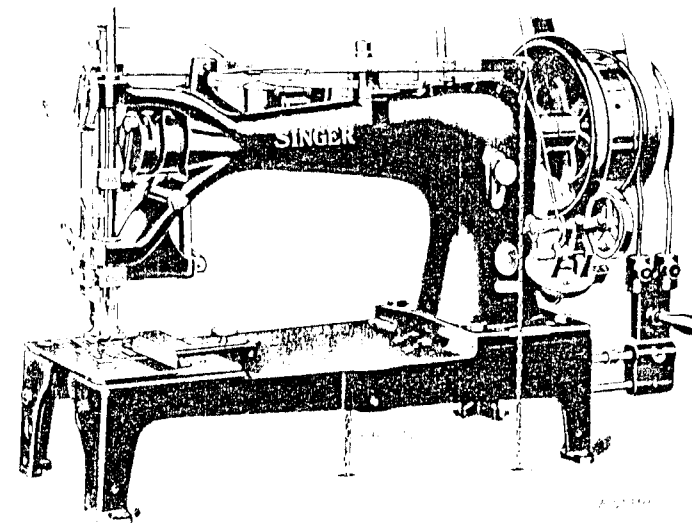

Singer Machine 7-27

THE SINGER MANUFACTURING CO.

Copyright © 1958 by The Singer Manufacturing Company

DESCRIPTION

Machines 7-27, 7-28, 7-38, 7-39, 7-44, 7-50, 7-51, 7-54 and 7-57 each have two needles and two shuttles. They are designed for sewing sails, tents, tarpaulins, canvas bags, awnings and other work in canvas or heavy fabrics. Machines 7-27, 7-28, 7-38, 7-39, 7-50 and 7-51 are also capable of sewing other heavy materials, such as leather, rubber, etc.

These machines should be run slower than the maximum speeds mentioned in the following descriptions, until the parts which are in movable contact become glazed by their action upon each other.

During operation, the balance wheel of the machine should always turn over toward the operator.

MACHINE 7-27 is furnished in gauges $3/4"$, $7/8"$ and $1"$. It is equipped with upper and lower feeding mechanism, consisting of a feeding foot and drop feed, either of which can be independently adjusted to feed the upper or under plies of fabric faster or slower as desired.

This machine is provided with foot lifter and belt shifter. Stitch length is adjustable from 2 to 8 to the inch.

Speed is up to 500 R.P.M., depending upon the nature of the material being stitched.

MACHINE 7-28 is furnished in gauges from $3/16"$ to $11/16"$, in steps of $1/16"$. The standard gauges are $1/4"$, $1/2"$, $9/16"$ and $5/8"$. The machine is equipped with vibrating presser foot or stationary presser foot. The order should specify which type of foot is wanted. Equipped with belt shifter.

Stitch length is adjustable from 2 to 8 to the inch.

Speed is up to 500 R.P.M., depending upon the nature of the material being stitched.

MACHINE 7-38. Same as Machine 7-27 except that it is equipped with SINGER Driving Attachment.

MACHINE 7-39. Same as Machine 7-28 except that it is equipped with SINGER Driving Attachment.

MACHINE 7-44 is furnished in gauges $3/4"$, $7/8"$ and $1"$. The standard gauge is $3/4"$. It has alternating pressers and is equipped with SINGER Driving Attachment. Stitch length is adjustable from 2 to 8 to the inch. Speed is up to 600 R.P.M., depending upon the nature of the material being stitched.

MACHINE 7-50. Standard gauge 1". Can be furnished in gauges up to 1-1/2", in steps of 1/8", at additional cost. The machine is equipped with adjustable vibrating presser foot or stationary presser foot. The order should specify which type of foot is wanted. It is equipped with belt shifter.

Stitch length is adjustable from 2 to 8 to the inch.

Speed is up to 500 R.P.M., depending upon the nature of the material being stitched.

MACHINE 7-51. Same as Machine 7-50 except that it is equipped with SINGER Driving Attachment.

MACHINE 7-54 is furnished in gauges from 1" to 1-1/2". It has independently adjustable upper and under feeds, and is equipped with SINGER Driving Attachment and foot lifter.

Stitch length is adjustable from 2 to 8 to the inch.

Speed is up to 500 R.P.M., depending upon the nature of the material being stitched.

MACHINE 7-57. Same as Machine 7-50 except that it is equipped with puller feed and SINGER Driving Attachment. It can be furnished in gauges from 1" to 1-1/2" at additional cost.

Needles

Needles for these two-needle Class 7 Machines are as follows:

Machine	Description	Class and Variety of Needles	Sizes of Needles
7-27	For Fabrics	7 x 1	21, 22, 23, 24, 25, 26, 27
7-28			
7-38		or	
7-39			
7-50	For Leather	7 x 2	21, 22, 23, 24, 25, 26, 27
7-51			
7-44	For Fabrics	7 x 1	21, 22, 23, 24, 25, 26, 27
7-54			
7-57			

The size of the needle is determined by the texture of the material to be sewn and by the size of the thread which must pass freely through the needle eye. Rough or uneven thread, or thread which passes with difficulty through the needle eye, will interfere with the successful use of the machine.

Orders for needles must specify the **QUANTITY** required, the **SIZE** number, also the **CLASS** and **VARIETY** numbers separated by an X. The following is an example of an intelligible order:

"50 No. 23, 7 x 1 Needles
50 No. 21, 7 x 2 Needles"

The best results will be obtained with needles furnished by the Singer Sewing Machine Company.

Thread

These machines all require left twist thread for the inside needle (the needle nearest the upright part of machine arm) and right twist thread for the outside needle (the needle farthest from upright part of machine arm) except when Machines 7-50, 7-51, 7-54 and 7-57 are furnished in gauges exceeding 1-1/8 inch (from 1-1/4 to 1-1/2 inch) in which case both the inside and outside shuttles require the use of left twist thread in both needles. The needle threading is then to the right (toward the upright part of machine arm) through the eye of each needle. Also in such case, both needles are set with the long grooves to the left. Otherwise the needle threading for all machines covered by this manual is as instructed on pages 10 to 13 inclusive, and the setting of the needles is as instructed on page 9.

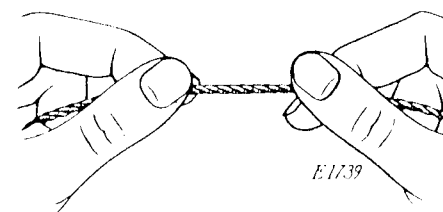

Fig. 2. How to Determine the Twist

Hold the thread as shown above. Turn the thread over toward you between the thumb and forefinger of the right hand; if left twist, the strands will wind tighter; if right twist, the strands will unwind.

Either right or left twist thread can be used for the bobbins.

To Remove the Left Bobbin (All Class 7, Two-Needle Machines)

Turn the balance wheel to bring the needle bar to its lowest position; then, with the curve of the Shuttle Cylinder Opener 120571, shown in Fig. 3, conforming to the curve of the shuttle cylinder, insert the small end of the shuttle cylinder opener in the slot (J, Fig. 3) in the spring latch beneath the shuttle cylinder, as shown in Fig.

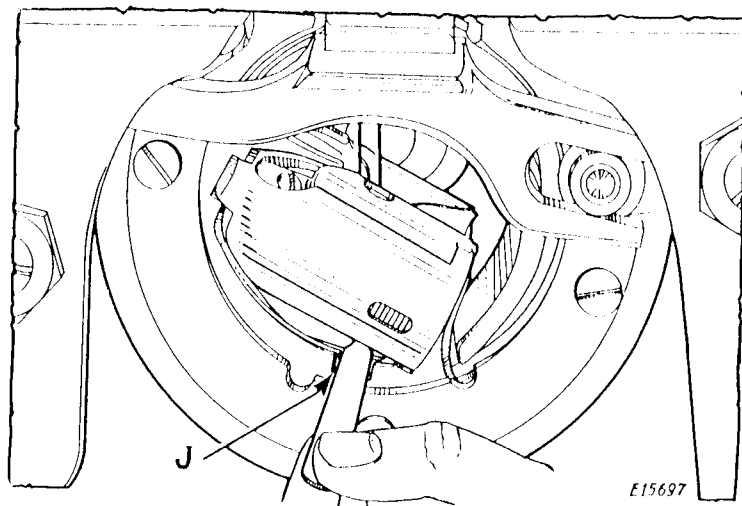

Fig. 3. Removing the Left Bobbin with Shuttle Cylinder Opener 120571

3. Press the latch away from the cylinder and turn the cylinder outward AND TOWARD THE LEFT as far as it will go, and the bobbin will drop out.

To Remove the Right Bobbin (All Class 7, Two-Needle Machines)

Use the Shuttle Cylinder Opener 120571 in the same manner as for removal of the left bobbin, as instructed above, except that in this case the shuttle cylinder is turned out AND TOWARD THE RIGHT as far as it will go, when the bobbin will drop out.

To Wind the Bobbin (All Class 7, Two-Needle Machines)

Place the bobbin on the bobbin winder spindle and push it closely against the shoulder having the small pin in the shoulder enter the slot in the bobbin.

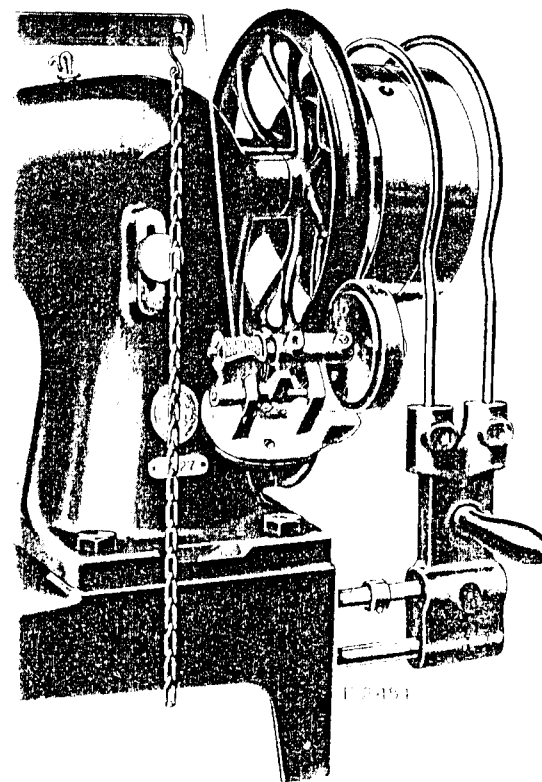

Fig. 4. Winding the Bobbin

Pass the thread from the unwinder through the hole in the left side of the bobbin from the inside. Push the bobbin winder pulley up against the balance wheel and place the bobbin winder latch in position as shown in Fig. 4. Then start the machine. The end of the thread must be held until a few coils are wound and should then be cut off. When sufficient thread has been wound upon the bobbin, the bobbin winder will stop automatically.

To Replace the Bobbins and Thread the Shuttles (All Class 7, Two-Needle Machines)

Place the bobbin for the LEFT shuttle into the cylinder as far as it will go, with the thread drawing off from the under side toward the

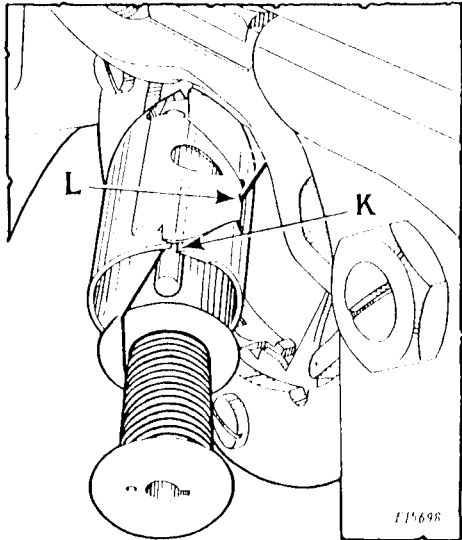

Fig.5. Replacing the Left Bobbin

left as shown in the above illustration. Draw the thread into the slot (K, Fig.5) in the cylinder and under the tension spring into the delivery eye at (L, Fig.5), then push the cylinder back until it is locked by the spring latch, allowing about three inches of thread to hang free from the shuttle with which to commence sewing.

To replace the bobbin for the RIGHT shuttle, place the bobbin into the cylinder as far as it will go with the thread drawing off from the

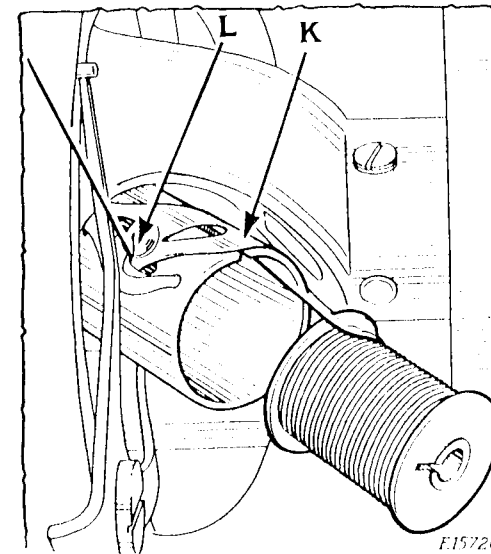

Fig.6. Replacing the Right Bobbin

underside toward the right as shown in the above illustration. Draw the thread into the slot (K, Fig.6) in the cylinder and under the tension spring into the delivery eye (L, Fig.6) then push the cylinder back until it is locked by the spring latch, allowing about three inches of thread to hang free from the shuttle with which to commence sewing.

To Set the Needles (All Class 7, Two-Needle Machines)

Turn the balance wheel to bring the needle bar to its highest position; loosen the needle set screws at each side of the needle clamp and insert the needles up into the needle clamp as far as they will go, with the long grooves of the needles facing each other, except when machines 7-50, 7-51, 7-54 and 7-57 are furnished in gauges from 1-1/4 to 1-1/2 inch, in which event both needles are inserted with the long grooves facing the left, as instructed under "THREAD", page 5. The eye of each needle should, in every instance, be directly in line with the machine arm. Tighten the set screws after the needles are in place.

**To Thread the Needles on All Class 7,
Two-Needle Machines (Except Machine 7-57)**
(See instructions under "THREAD" page 5)

Turn the balance wheel over toward you until the needle bar moves up to its highest position.

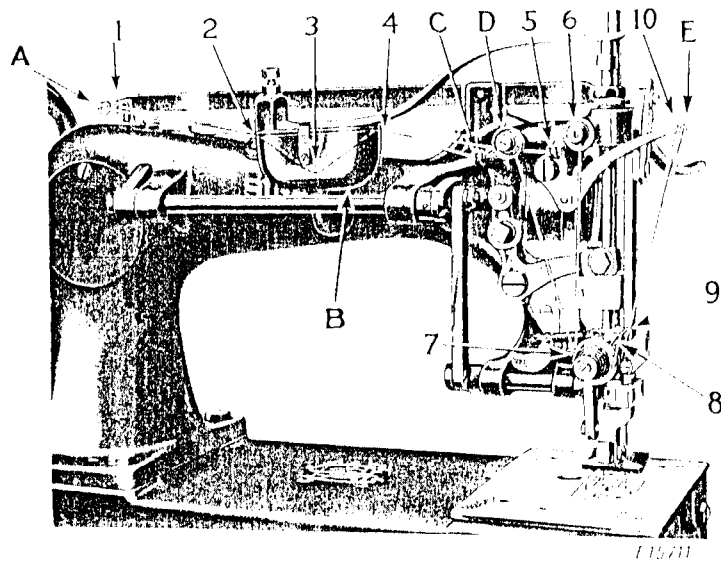

Fig. 7. Threading Needles of All Class 7, Two-Needle Machines
(Except Machine 7-57)

TO THREAD THE INSIDE NEEDLE (needle nearest upright part of arm), use left twist thread and pass the thread from the unwinder forward through eyelet (1, Fig. 7). Raise lid of cup (B, Fig. 7) and pass the thread forward through hole (2, Fig. 7) at rear end of cup, forward through hole (3, Fig. 7) in the lug at under side of cup lid, forward through hole (4, Fig. 7) at front end of cup, forward through eyelet (C, Fig. 7), over and between thread retainer discs (D, Fig. 7), down under from back to front and completely around the outer groove of tension wheel (7, Fig. 7), into the loop of take-up spring (8, Fig. 7), under the staple (9, Figs. 7 and 8), up and from back to front, toward the operator, through hole (10, Figs. 7 and 8) in the take-up lever, down and back of bracket (11, Fig. 8), down through the right hand thread eyelet (12, Fig. 8) at the back of the needle clamp, and down from left to right (toward upright part of arm) through the eye (13, Fig. 8) of the needle.

TO THREAD THE OUTSIDE NEEDLE (needle farthest from upright part of arm), use right twist thread and pass the thread from the unwinder forward through eyelet (A, Fig. 7), forward through hole (2, Fig. 7) at rear end of cup (B, Fig. 7), forward through hole (3, Fig. 7) in the lug at under side of cup lid, forward through hole (4, Fig. 7) at front end

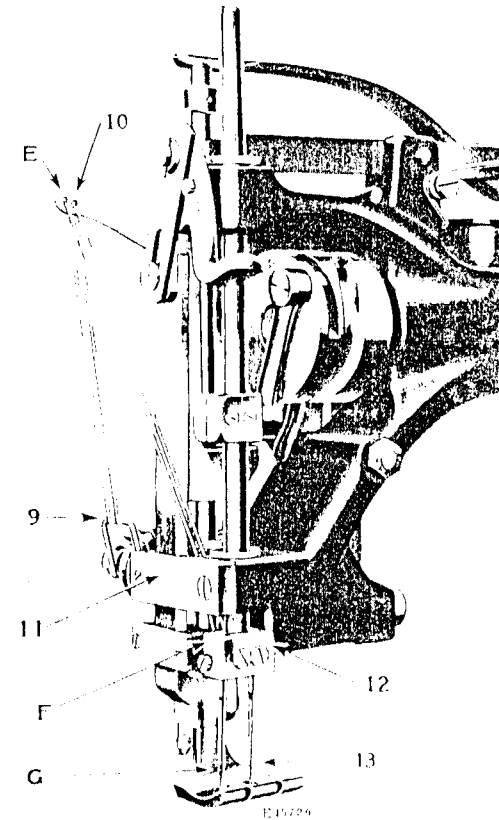

Fig. 8. Threading Needle of All Class 7, Two-Needle Machines
(Except Machine 7-57)

of cup, forward through eyelet (C, Fig. 7), over and between thread retainer discs (D, Fig. 7), down under from back to front and completely around the outer groove of tension wheel (7, Fig. 7), into the loop of take-up spring (8, Fig. 7), under staple (9, Figs. 7 and 8), up and from back to front, toward the operator, through hole (E, Figs. 7 and 8) in the take-up lever, down and back of bracket (11, Fig. 8), down through left hand thread eyelet (F, Fig. 8) at the back of the needle clamp, and down from right to left (away from upright part of arm) through the eye (G, Fig. 8) of the needle.

Close the lid of the thread retainer cup (B).

To Thread the Needles on Machine 7-57

(See instructions under "THREAD" page 5)

Turn the balance wheel over toward you until the needle bar moves up to its highest position.

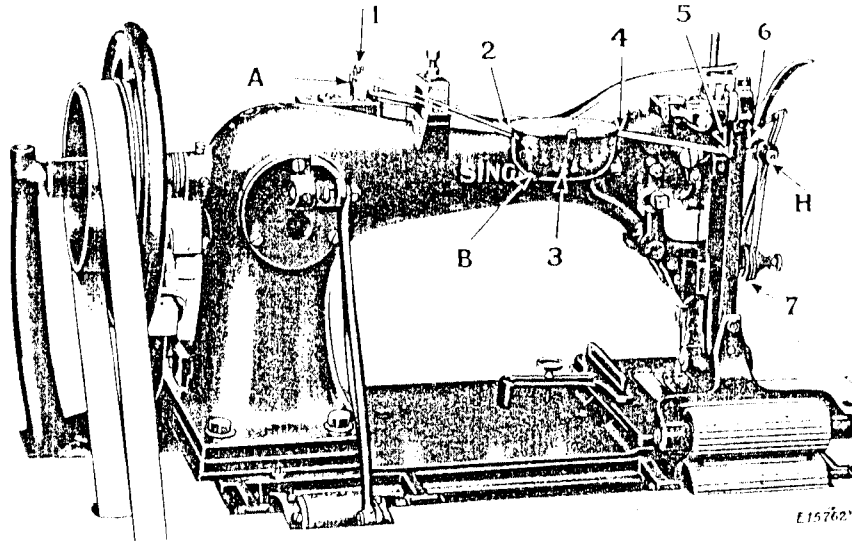

Fig. 9. Threading Needles on Machine 7-57

TO THREAD THE INSIDE NEEDLE (needle nearest upright part of arm), use left twist thread and pass the thread from the unwinder forward through eyelet (1, Fig. 9). Raise lid of cup (B, Fig. 9) and pass the thread forward through hole (2, Fig. 9) at the rear end of the cup, forward through hole (3, Fig. 9) in the lug at under side of cup lid, forward through hole (4, Fig. 9) at front end of cup, forward and beneath guide bar (5, Fig. 9), forward over and between tension discs (6, Figs. 9 and 10), down under from back to front and completely around the inner groove of tension wheel (7, Figs. 9 and 10) at the lower part of the face plate, then up through the loop (8, Fig. 10) of the take-up spring and to the rear side (away from the operator) of the staple (9, Fig. 10), up and from back to front, toward the operator, through the hole (10, Fig. 10) in the thread take-up, down through the wire guide (11, Fig. 10); down through the wire guide (12, Fig. 10) at the bottom of the face plate, down through the right-hand hole (13, Fig. 10) at the back of the needle clamp, and down to the right (toward the upright part of the machine arm) through the eye (14, Fig. 10) of the needle.

TO THREAD THE OUTSIDE NEEDLE (needle farthest from upright part of arm), use right twist thread and pass the thread from the unwinder forward through eyelet (A, Fig. 9), then forward through hole (2, Fig. 9) at the rear end of cup (B, Fig. 9), forward through the hole (3, Fig. 9) in the lug at under side of cup lid, forward through hole (4, Fig. 9) at

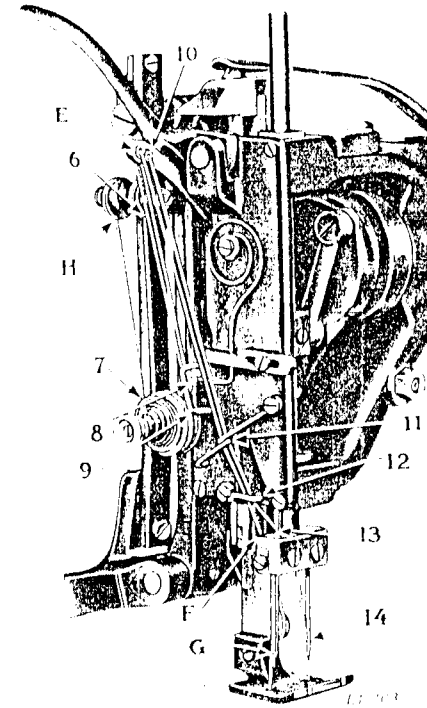

Fig. 10. Threading Needles on Machine 7-57

the front end of cup, forward and beneath guide bar (5, Fig. 9), forward over and between tension discs (H, Figs. 9 and 10), down under from back to front and completely around the outer groove of the tension wheel (7, Fig. 10) at the lower part of the face plate, then up through loop (8, Fig. 10) of the take-up spring, and to the rear side, away from the operator, of the staple (9, Fig. 10), up and from back to front, toward the operator, through the hole (E, Fig. 10) in the thread take-up, down through the wire guide (11, Fig. 10), down through the wire guide (12, Fig. 10) at the bottom of the face plate, down through the left hand hole (F, Fig. 10) at the back of the needle clamp and down and to the left (away from the upright part of the machine arm) through eye (G, Fig. 10) of the needle.

To Prepare for Sewing (All Class 7, Two-Needle Machines)

With the left hand, hold the ends of the needle threads, leaving them slack from the hand to the needles. Turn the balance wheel over

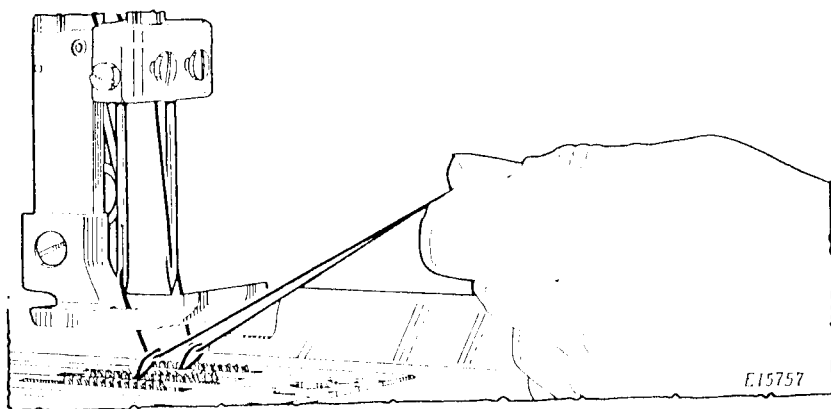

Fig. 11. Drawing Up the Bobbin Threads

toward you until the needles move down and up again to their highest position, thus catching the bobbin threads; draw up the needle threads and the bobbin threads will come up with them through the holes in the throat plate (see Fig. 11). Then lay the threads back under the presser foot.

To Commence Sewing (All Class 7 Two-Needle Machines except Machine 7-57)

Place the material beneath the presser foot, lower the presser foot and commence to sew, turning the balance wheel over toward you.

To Commence Sewing (Machine 7-57)

Place the material beneath the presser foot, raise the upper feed roll, lower the presser foot and commence to sew, turning the balance wheel over toward you. When the material feeds back beneath the upper feed roll, lower the upper feed roll upon the material.

Tensions

When stitching one thickness of material, the needle and bobbin threads may be locked in the center of the material if desired, but the stitch will be equally as strong if the tensions are so adjusted that the lock is only within the under side of the material. This method uses less of the bobbin thread (which must be wound) while the needle thread is supplied from the cop or spool.



Fig. 12. Showing Correct Position of Lock Stitch in Center of One Thickness of Material

When stitching two or more plies of material, the needle and bobbin threads should be locked well into the lower ply of material, thus:



Fig. 13. Showing Correct Position of Lock Stitch When Two or More Plies are Being Sewn

If the tension on the needle thread is too tight, or if that on the bobbin thread is too loose, the thread will lie straight along the upper surface of the material, thus:



Fig. 14. Tight Needle Thread Tension

If the tension on the bobbin thread is too tight, or if that on the needle thread is too loose, the bobbin thread will lie straight along the underside of the material, thus:



Fig. 15. Loose Needle Thread Tension

To Remove the Work (All Class 7, Two-Needle Machines except Machine 7-57)

Stop the machine with the thread take-up lever resting at its highest position; draw about four inches of thread through the thread retaining discs (D and 6, Fig. 16, page 17), raise the presser foot, draw the work back and cut the threads close to the material. Leave the ends of the threads under the presser foot.

To Remove the Work (Machine 7-57)

Stop the machine with the thread take-up lever resting at its highest position; draw about four inches of thread through the thread retaining discs (H and 6, Fig. 17, page 17), raise the presser foot and raise the upper feed roll, draw the work back and cut the threads close to the material. Leave the ends of the threads under the presser foot.

To Regulate the Tensions

The tension on the needle threads is regulated by means of the thumb nuts (M and N, Fig. 16, page 17) at the front of the two tension discs (D and 6, Fig. 16) and the thumb nut (O, Fig. 16) at the front of the tension wheel (7, Fig. 16) ON ALL CLASS 7, TWO-NEEDLE MACHINES EXCEPT MACHINE 7-57; or by means of the two thumb nuts (P and Q, Fig. 17, page 17) at the front of the two tension discs (H and 6, Fig. 17) and the thumb nut (R, Fig. 17) at the front of the tension wheel (7, Fig. 17) ON MACHINE 7-57.

In each case the tension is increased by turning the thumb nuts in a clockwise direction, or in a counter-clockwise direction to decrease the tension.

The tension at the discs (D and 6) or (H and 6) should be just sufficient to cause the rollers in the tension wheel (7) to revolve as the thread passes completely around them, and the thumb nut (O) or

(R) should be tightened just enough to produce the proper setting of the stitch.

In each case, the tension of the bobbin threads is regulated by

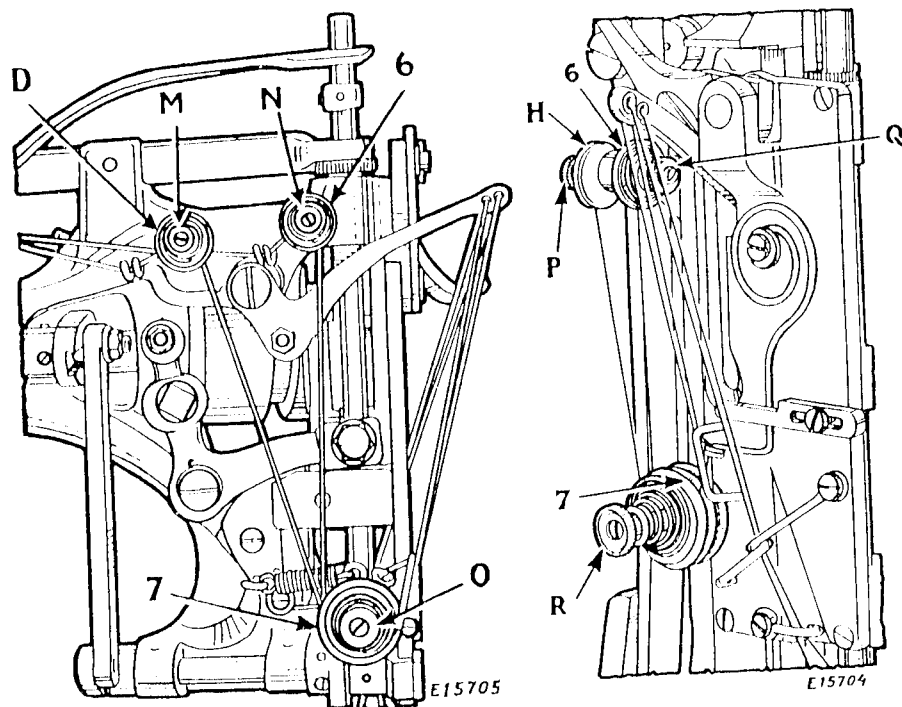

Fig. 16. To Regulate the Tensions
All Class 7, Two-Needle Machines
Except Machine 7-57

Fig. 17. To Regulate the Tensions
Machine 7-57

means of the screw which holds the tension spring to each shuttle cylinder. To increase the tension, turn the screw in a clockwise direction, or turn the screw in a counter-clockwise direction to decrease the tension.

To Regulate Stitch Length All Class 7, Two-Needle Machines

Stitch length is regulated by means of the thumb screw (S, Fig. 18) in the slot at the front side of the machine arm.

To lengthen the stitch, loosen this thumb screw and move it downward, or move the thumb screw upward to shorten the stitch.

When stitch length regulation is completed, tighten the thumb screw (S).

To Regulate Pressure on the Material All Class 7, Two-Needle Machines

Loosen the lock nut (T, Fig. 18) and turn the adjusting screw (U, Fig. 18) downward to increase the pressure on the material, or turn

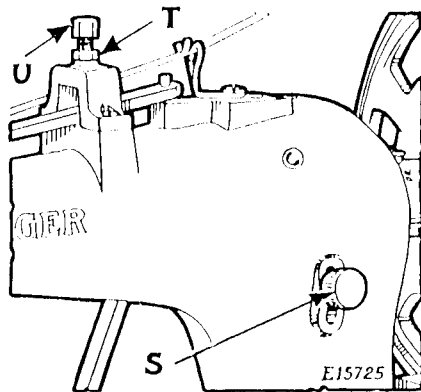

Fig. 18. Regulate Pressure on the Material; also Adjust Stitch Length
the screw (U) upward for less pressure, then tighten the lock nut (T).

The pressure should be only heavy enough to enable the feed to move the work along evenly, and to prevent the work from rising with the needle.

To Adjust Vibrating Presser Foot for Various Thicknesses of Materials All Class 7, Two-Needle Machines

As the work is fed through, the presser foot moves back with the material and, at the completion of the stitch, the foot lifts and returns to its former position for the following stitches.

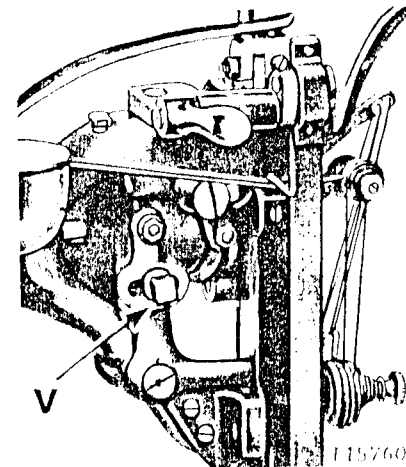

Fig. 19. Adjusting Presser Foot for Various Thicknesses of Materials

The presser foot must hold the work firmly at all times, its height being adjustable for various thicknesses of material.

To adjust, loosen adjusting screw (V, Fig. 19) and move it toward the balance wheel for less height (thinner material), or move this screw in a direction away from the balance wheel for greater height (thicker material), then firmly tighten the screw (V).

To Oil the Sewing Machines

Use only TYPE B for general use, or TYPE D OIL where a stainless oil is desired.

To insure easy running and prevent unnecessary wear, all parts which are in movable contact require oiling, and when the machine is in continuous use, oil should be applied frequently.

Oiling Points are indicated in Figs. 20 to 23, inclusive, by arrows. Turn aside the arm side cover at rear side of machine arm and oil all moving parts inside machine arm, as indicated in Fig. 21.

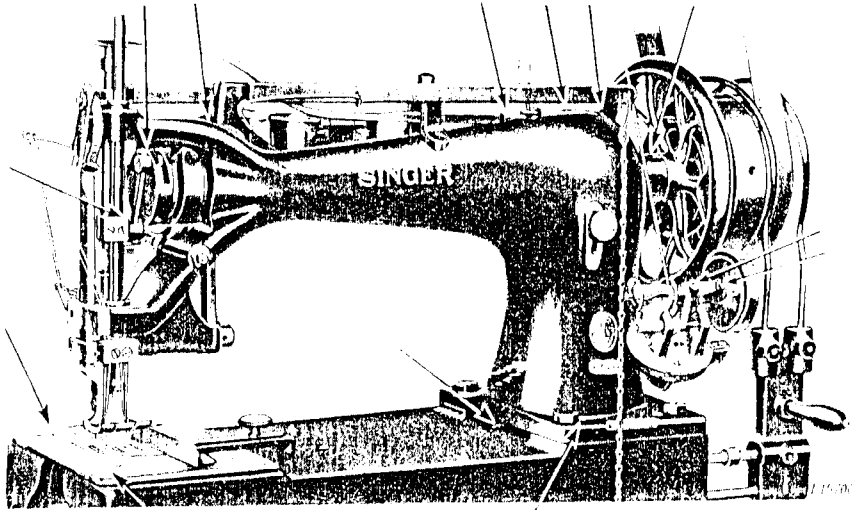

Fig. 20. Oiling Points at Front Side (All Class 7, Two-Needle Machines Except Machine 7-57)

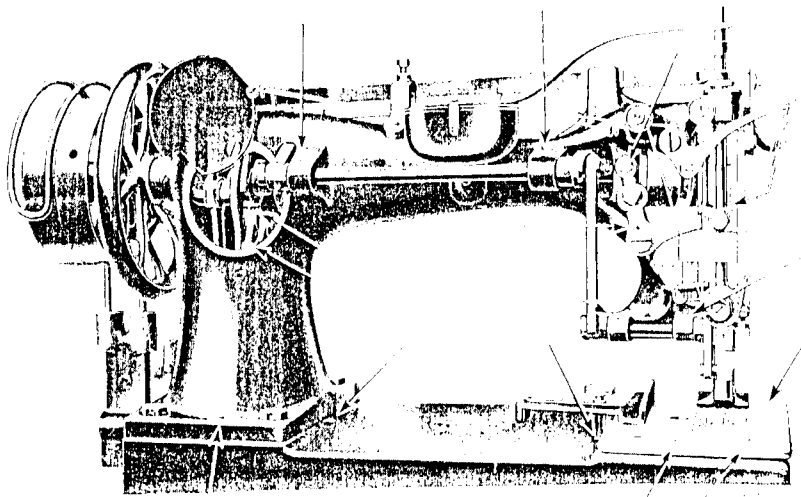

Fig. 21. Oiling Points at Rear Side (All Class 7, Two-Needle Machines Except Machine 7-57)

Close the arm side opening when oiling is completed. THE ARM SIDE COVER OF MACHINE 7-57 SHOULD NOT BE OPENED FOR OILING. In this ma-

chine, parts inside the machine arm are oiled through the hole in the arm side cover as indicated in Fig. 23.

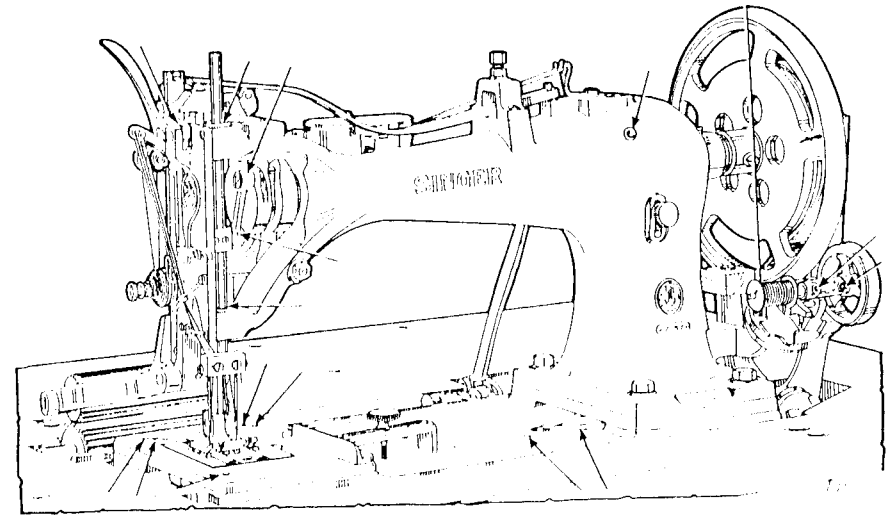

Fig. 22. Oiling Points at Front Side of Machine 7-57

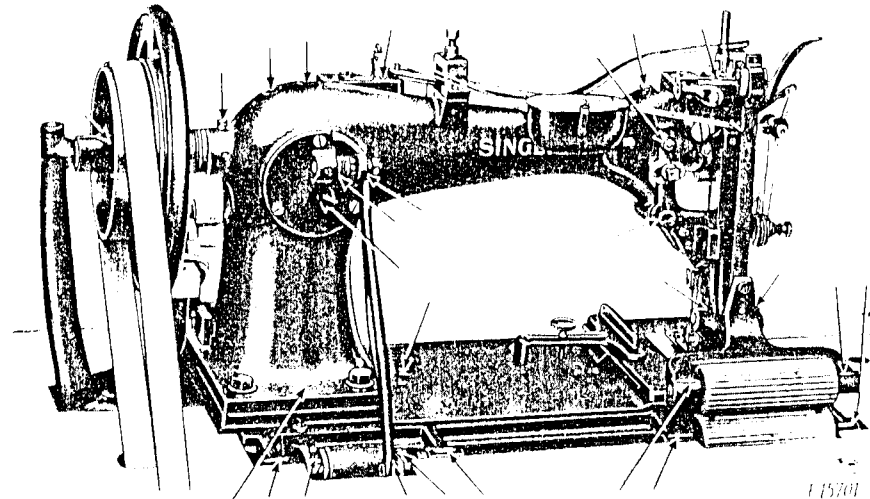

Fig. 23. Oiling Points at Rear Side of Machine 7-57

NOTE - In addition to the oiling points indicated in Figs. 20 to 23, inclusive, oil should be applied regularly to the shuttle race.

INSTRUCTIONS FOR ADJUSTERS AND MECHANICS

To Regulate the Feed Rolls - Machine 7-57

The movement of the feed rolls should slightly exceed the movement of the feed dog, so that the extent of the pulling action of the feed rolls will be slightly greater than the feeding action of the feed dog. This will insure that the material will be perfectly flat and with no tendency to pucker between the feed dog and the feed rolls.

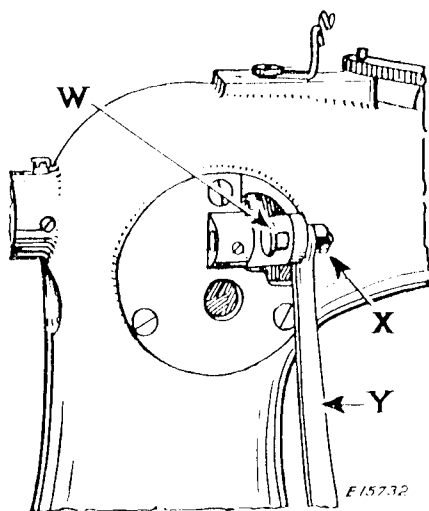

Fig.24. Adjusting Feed Rolls - Machine 7-57

Only the lower of the two feed rolls is adjustable, the feeding movement of the upper feed roll being imparted to it by the lower feed roll.

To adjust, loosen nut (X, Fig. 24) and move the upper end of the feed roll connection (Y, Fig. 24) outward (away from the machine) in the slot (W) for more feeding movement of the feed rolls; or move the connection (Y) inward (toward the machine) for less feeding movement of the feed rolls, then securely tighten the nut (X).

Timing (All Class 7, Two-Needle Machines)

The machines are correctly timed at the factory and are so constructed that such timing is permanently fixed. Therefore no adjustment for timing is provided.

To Set the Needle Bar (All Class 7, Two-Needle Machines)

When the shuttle point is at the center of the needle, the top of the needle eye should be approximately $1/32$ inch below the point of the shuttle.

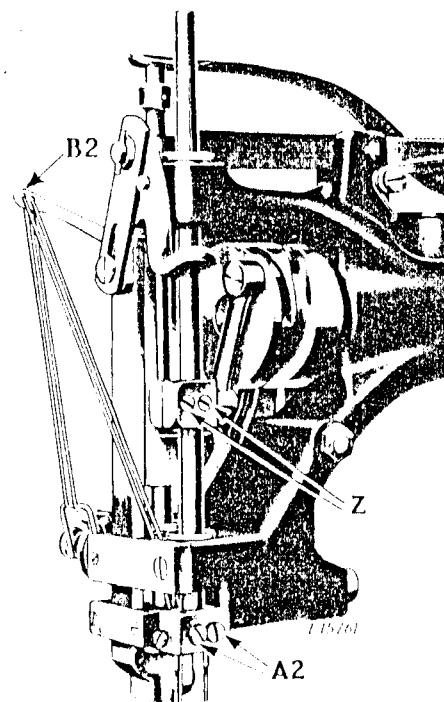

Fig.25. To Set Needle Bar; To Set Needle Clamp; To Time the Feed

To adjust, loosen the two clamping screws (Z, Fig. 25) and move the needle bar up or down as required, then securely tighten the clamping screw (Z).

NOTE - This setting of the needle bar may be varied slightly depending upon the size of the needle and the thread being used.

To Set the Needle Clamp (All Class 7, Two-Needle Machines)

The needle clamp is adjustable to right or left. To adjust, loosen the two clamping screws (A2, Fig. 25, page 23) and move the clamp to the left or right, as required, to bring the needles as close as possible to, but without actually touching, the shuttle points. Securely tighten the two screws (A2).

To Time the Feed (All Class 7, Two-Needle Machines)

For general sewing conditions, the feed dog should be set to start to feed the work when the thread take-up lever (B2, Fig. 25, page 23), on its upward stroke, has traveled approximately 1-3/4 inch from its lowest position. WHEN THE MACHINES LEAVE THE FACTORY, THEY ARE PROPERLY TIMED and no adjustment is necessary unless the position of the feed cam has been disturbed.

If adjustment should be considered necessary, remove the arm side cover at the rear side of the machine arm. The feed cam is easily accessible with the arm side cover removed. This feed cam is provided with two screws. Loosen these screws and set the cam for earlier or later movement of the feed dog, as required, by turning the cam about the arm shaft to the required position, then securely tighten the two screws in the cam.

The Same!

To get replacements
that are the same
as parts in new
machines.

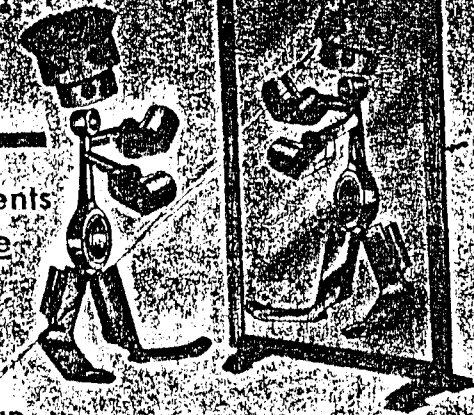

BUY PARTS AND
NEEDLES MADE BY SINGER

TO BE DOUBLY SURE

of new machine performance, make sure that all
replacement parts and needles are precisely
identical to those in new SINGER machines.

Look for the trademark

SINGER or SIMANCO

- ① on every package or container
- ② on the needle or numbered part

Needles in containers marked "For Singer Machines" are NOT made by SINGER

TO ALL WHOM IT MAY CONCERN:

The improper placing or renewal of the Trademark "SINGER" or any other of the Trademarks of The Singer Manufacturing Company (all of which are duly Registered Trademarks) on any machine that has been repaired, rebuilt, reconditioned, or altered in any way whatsoever outside a SINGER factory or an authorized SINGER agency is forbidden.