

Form K1852

INSTRUCTIONS
FOR USING
SINGER
SEWING MACHINES
CLASS 31K
(EXCEPT 31K32)
CENTRAL BOBBIN

WARNING

**It is essential that the machine should
be kept well oiled, in accordance with
the instructions given on pages 13 and
14 of this book**

* A Trade Mark of THE SINGER MANUFACTURING CO.

SINGER -
ELECTRIC
MOTORS

OF HIGHEST
EFFICIENCY -
REASONABLE
IN PRICE - -
EASILY APPLIED

THE MOTOR DRIVES THE MACHINE — THE
OPERATOR MERELY GUIDES THE MATERIAL
ENSURING MORE AND BETTER WORK.

To all whom it may concern :

The improper placing or renewal of the trade-mark " SINGER " or any other of the trade-marks of The Singer Manufacturing Company (all of which are duly Registered Trade-marks) on any machine that has been repaired, rebuilt, reconditioned or altered in any way whatsoever outside a SINGER factory or an authorised SINGER agency is forbidden.



A brass plate, similar in shape to the above illustration, is fastened upon each Singer Sewing Machine made for manufacturing purposes. This plate is usually at the right hand upon the arm, and bears the two numbers that designate the machine. As Class 31K Machines are furnished in a number of varieties, each of which differs in detail from the others, it is necessary when ordering parts or supplies (unless the correct number of each part is known) to state the class and variety of the machine, as shown on the brass plate, and so prevent misunderstanding and delay in filling orders.

SPEED.

The maximum speed recommended for Machines Nos. 31K15, 31K20 and 31K22 is 2,200 stitches per minute ; and for 31K17, 31K21, 31K47 and 31K48, 2,000 stitches per minute. These machines are very closely fitted, and should therefore be run at less than the maximum speed at first, until the parts have been run in.

Machines of Class No. 31K are regularly fitted with a fixed machine pulley, but when required for operation on treadle stand they may, if so ordered, be supplied with a machine pulley stop motion.

Stop Motion.

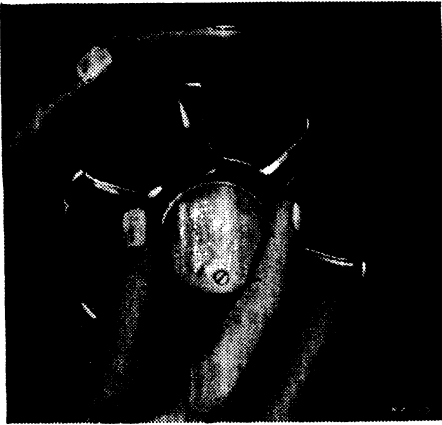

Fig. 1.

This device allows the machine pulley to run free, so that bobbins may be wound, and correct treading acquired without operating the mechanism. To loosen the pulley, hold it with the left hand, and with the right hand turn the stop motion screw over toward you, as shown in Fig. 1.

To Operate the Treadle Machine.

NOTE.—If the machine is fitted with stop motion, loosen machine pulley when learning to treadle (see Fig. 1).

Place both feet upon the treadle and turn the machine pulley toward you, at the same time allowing the feet to move freely and lightly with the motion of the treadle. Continue to do this until a regular and easy movement is acquired and you are able to restart the machine without the machine pulley turning in the wrong direction.

When familiar with the working movement, re-tighten the machine pulley (see Fig. 1) if the machine is fitted with stop motion. Place a piece of calico or cloth under the presser foot (6, Fig. 2), lower the latter upon the material by means of the presser bar lifter (2, Fig. 2) and again work the machine, without being threaded, until you have become accustomed to guiding the material.

To Ensure Perfect Action of the Machine.

The machine pulley must always turn over toward you.

Do not work the machine with the presser foot lowered or with the bobbin case and needle threaded, except when sewing.

The slide over the bobbin case must be kept closed.

To Set the Needle.

(See Fig. 2.)

Raise the needle bar (15) to its highest point and loosen the needle clamp screw (8). Insert the needle up into the needle clamp (5) as far as it will go, with its long groove to the left and the eye directly in line with the arm of the machine; then re-tighten the screw.

To Thread the Needle.

(See Fig. 2.)

Turn the machine pulley toward you until the thread take-up lever (14) is at its highest point. Place a reel of thread on the spool pin of the machine and pass the end of thread from right to left through the top hole in the thread retainer (13), back through its middle hole and from right to left through the bottom hole. Then down and from the right between the tension discs (11), up into the loop of the thread take-up spring (4), under the

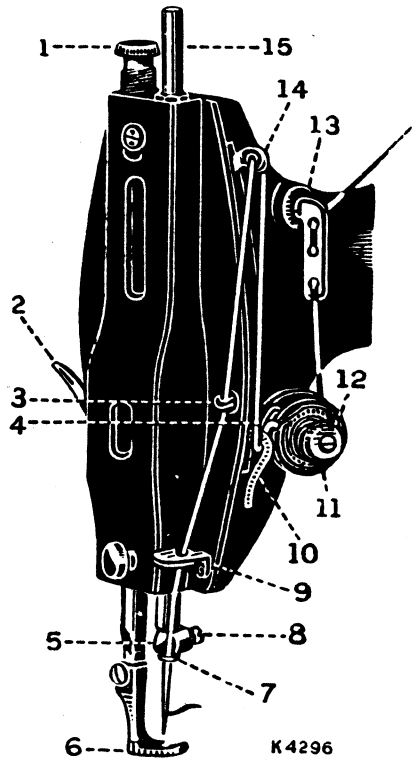

Fig. 2.

To Thread the Needle—Continued.

slack thread regulator (10), from right to left through the hole in the end of the take-up lever (14), down through the upper thread guide (3), and through the lower thread guide (9), then into the wire guide (7), and from left to right through the eye of the needle, leaving an end of thread three or four inches long with which to commence sewing.

To Remove the Bobbin Case and Bobbin.

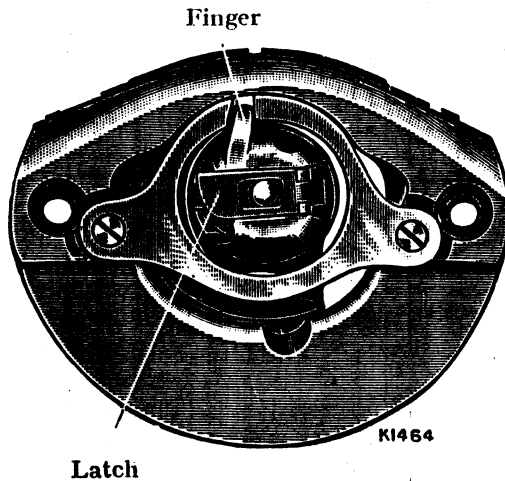

Fig. 3.

Turn the machine pulley toward you until the take-up lever (14, Fig. 2) is at its highest point, draw open the slide in the bed of the machine and, reaching down the thumb and forefinger of the left hand, open the latch (see Fig. 3) and withdraw the bobbin case.

While the latch is held open, the bobbin is retained in the bobbin case. On releasing the latch and turning the bobbin case downward, the bobbin will drop out.

To Wind the Bobbin (See Fig. 4).

Fasten bobbin winder to the table with its driving pulley in front of machine belt, so that the pulley will drop away from the belt when sufficient thread has been wound upon the bobbin.

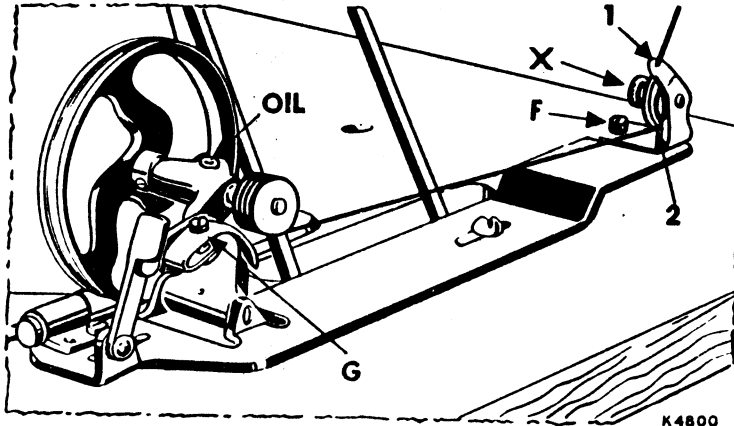

Fig. 4.

Place bobbin on bobbin winder spindle and push it on as far as it will go.

Pass thread down through thread guide 1 in tension bracket, around the back of, and between tension discs 2. Then wind end of thread around bobbin a few times in the direction shown in Fig. 4, push bobbin winder pulley over against machine belt and start machine.

When sufficient thread has been wound upon the bobbin, the bobbin winder will stop automatically.

If thread does not wind evenly on bobbin, loosen screw **F** in tension bracket and move bracket to right or left as may be required, then tighten the screw.

The amount of thread wound on bobbin is regulated by screw **G**. To wind more thread on bobbin, turn screw **G** inwardly. To wind less thread on bobbin, turn this screw outwardly.

Bobbins can be wound while machine is stitching.

When winding a bobbin with fine thread, a light tension should be used. Adjust knurled nut **X** to regulate the tension.

To Thread the Bobbin Case.

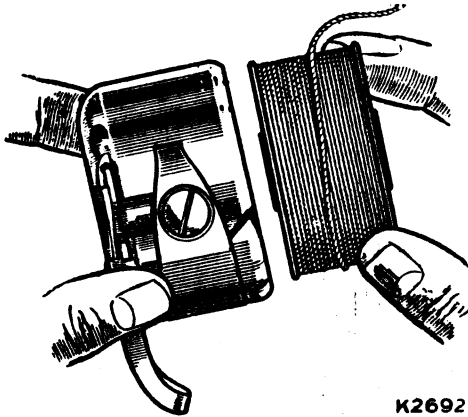

Fig. 5.

Hold the bobbin in the right hand, with the thread leading from left to right, as shown in Fig. 5 ; with the left hand hold the bobbin case with its open end up, and place the bobbin into it.

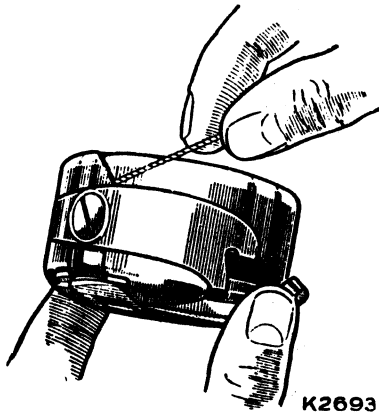

Fig. 6.

With the right hand draw the thread into the slot in the edge of the bobbin case, as shown in Fig. 6.

To Thread the Bobbin Case—Continued.

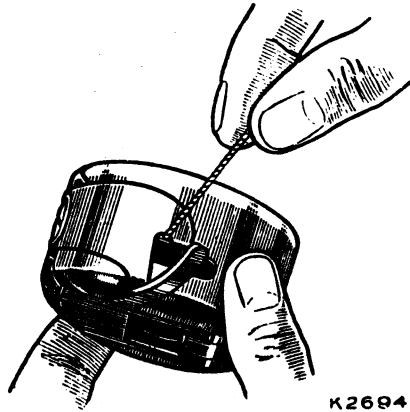

Fig. 7.

Then pull the thread to the right, under the tension spring, and into its delivery eye, as shown in Fig. 7.

To Replace the Bobbin Case.

After threading, hold the bobbin case by the latch between the thumb and forefinger of the left hand and replace it on the centre stud of the bobbin case holder, with its position finger opposite the notch at the top of the shuttle race, as shown in Fig. 3; then release the latch and press the bobbin case back until the latch catches the groove near the end of the stud. Allow the end of thread to hang free, and close the slide in the machine bed.

To Prepare for Sewing.

With the left hand hold the end of the needle thread, leaving it quite slack from the hand to the

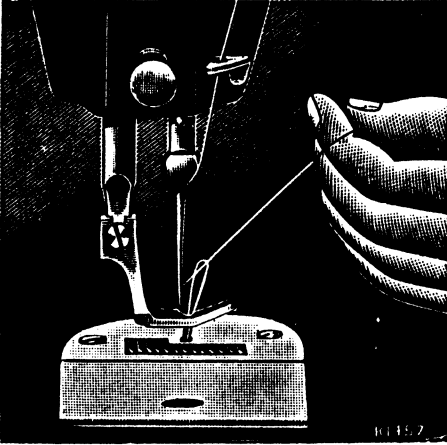

Fig. 8.

needle; turn the machine pulley toward you until the needle moves down and up again to its highest point, thus catching the under thread; then pull the end of the needle thread you are holding and the under thread will be brought up with it through the needle hole in the

throat plate, as shown in Fig. 8. Lay both ends of thread back under the presser foot.

To Commence Sewing.

Place the material to be sewn beneath the presser foot, lower the foot upon it, and commence to sew by turning the machine pulley over toward you.

NOTE.—Do not try to help the feeding of the work by pulling the material, as this may deflect the needle and cause it to break. The machine feeds without any assistance.

To Remove the Work.

Raise the thread take-up lever (14, Fig. 2) to its highest point and lift the presser foot; then move the material back and to the left, and sever the threads. Leave the ends of the threads a few inches long under the presser foot.

To Regulate the Tensions.



Correct Stitch.

For ordinary stitching, the tension on the upper and under threads should be equal, and just sufficiently strong to lock both threads in the centre of the work, as shown in the above illustration.

If either tension is stronger than the other, imperfect stitching will be the result, thus :—



Needle thread tension
too strong.



Needle thread tension
too weak.

A correct stitch can usually be obtained by varying the tension on the needle thread (see Fig. 9).—To increase the tension, turn the thumb nut in the direction illustrated by the arrow ; to lessen the tension, turn the nut in the opposite direction.

As all machines are correctly adjusted before leaving the factory, the shuttle tension seldom requires to be altered, but if this becomes necessary tighten the screw in the tension spring on the outside of the bobbin case to increase the tension, or loosen it slightly to lessen the tension.

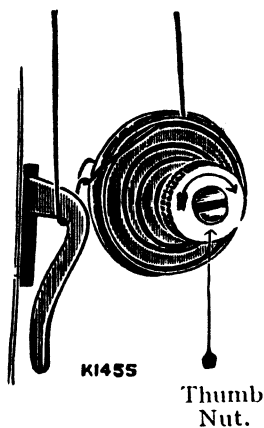

Fig. 9.

Always use thread with corresponding size of needle as per Table on page 3 of cover.

To Alter the Length of Stitch.

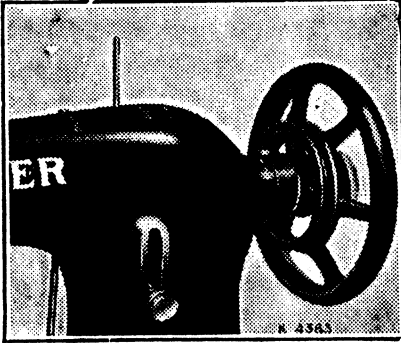

Fig. 10.
Position for Long Stitch.

The length of stitch is regulated by the large thumb screw in the slot in the front of the arm near the machine pulley (see Fig. 10). Loosen this screw and move it downward to lengthen, or upward to shorten, the stitch; then re-tighten the screw.

To Change the Pressure on Material.

To increase the pressure, give the thumb screw (1, Fig. 2) a few turns downward. To lessen the pressure, turn the screw upward. Pressure should be only sufficient to enable the feed to move the work evenly.

To Turn a Corner.

Stop the machine when the needle is at its lowest point, raise the presser foot and turn the work, as desired, using the needle as a pivot. Then lower the presser foot.

To Sew Flannel or Bias Seams.

Use a short stitch and as light a tension as possible on the needle thread, so that the stitching will be loose enough to allow the material to stretch.

To Oil the Machine and Stand.

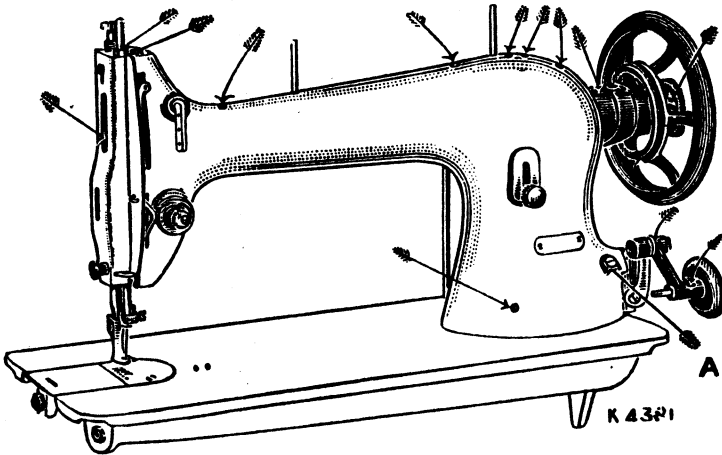

Fig. 11.

To ensure easy and quiet working of the machine, it is necessary that all moving parts in contact with each other should be covered with a film of oil and not allowed to become dry.

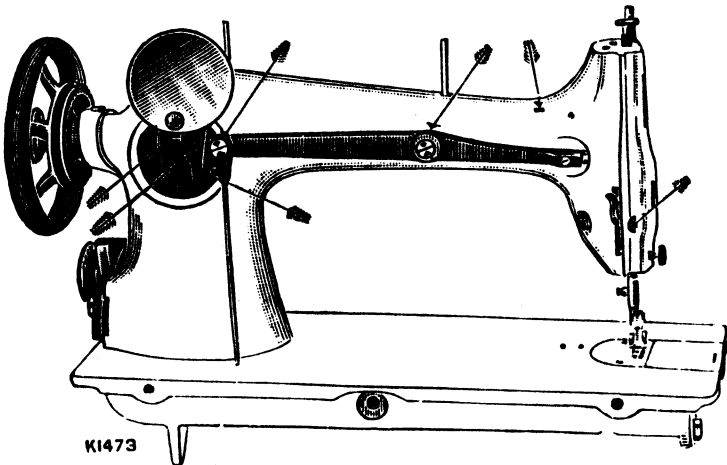

Fig. 12

To Oil the Machine and Stand—Continued.

The shuttle race, and points indicated by arrows in Figs. 11, 12 and 13, should be oiled frequently. A drop of oil is sufficient at any place.

To oil the oscillating rock shaft bearings, remove the oil reservoir stop screw (A, Fig. 11), and fill the reservoir with oil. When replacing the screw, take care that the leather washer is under its head and that the latter is forced down firmly on to the washer to seal the top of the oil reservoir. Otherwise the oil will flow out too rapidly and empty the reservoir, with the result that the bearings will become heated for want of lubrication.

After oiling, run the machine rapidly for a few minutes to work the oil into the bearings. If the machine is in constant use it should be oiled daily.

To oil the stand, apply a drop of oil to the centres upon which the band wheel and treadle work, and to both ends of the pitman rod connecting the treadle with the band wheel.

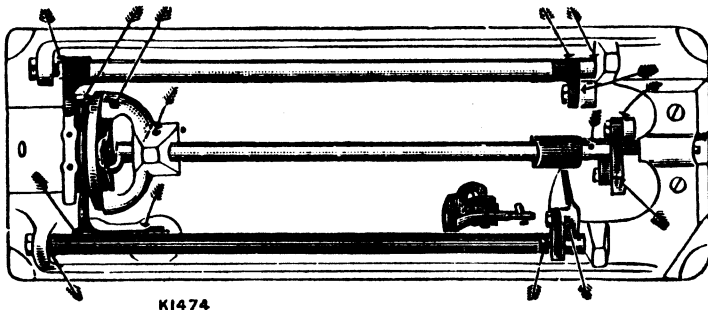

Fig. 13.

Always use SINGER Oil. Inferior oil clogs the bearings, prevents efficient working, and causes rapid wear of the mechanism. See page 2 of cover.

H I N T S.

Machine Working Heavily.—If, after standing for some time, the machine works heavily, use a little paraffin in place of oil. Then run rapidly, wipe clean and oil with SINGER oil. The use of inferior oil is usually the cause of a machine working heavily. See that the leather belt is not too tight; it should be just tight enough not to slip. If too long, shorten and rejoin.

Skip Stitches.—A bent or blunt-pointed needle is often the cause of this. See that the needle is accurately set (see page 5). Remove the throat plate and, after seeing that the feed is clean and working freely, replace the throat plate.

Thread Breaking.—If the needle thread breaks, it is probably due to one of the following causes:

- The machine being improperly threaded.
- The tensions being too tight.
- The needle being bent or having a blunt point.
- The thread being too coarse for the size of the needle (see Table on inside of back cover).
- The thread take-up spring (4, Fig. 2) being broken.

If the under thread breaks, adjust the under tension (see page 11); also see that the inside of the bobbin case and under the tension spring are free from fluff.

Needles Breaking.—See that the needle is not bent, that the top tension is not too tight, and avoid pulling the material when stitching. Any of these errors will cause the needle to strike on the throat plate and break. Use SINGER Needles sold only at SINGER Agencies.

HINTS—Continued.

Other makes of needles are often of inferior quality ; they become blunt, break easily and prevent the efficient working of the machine.

Material Puckering.—This is generally due to irregular tensions. See page 11 for the regulation of tensions.

Stitches Looping.—This is regulated by the tensions (see page 11). See that both the bobbin case and the needle are properly threaded, and that the thread used is of good quality and the correct size for the needle (see Table on inside of back cover). Make sure that the thread take-up spring (4, Fig. 2) is not broken.

THE IMPORTANCE OF USING SINGER PARTS AND NEEDLES IN SINGER MACHINES

The successful operation of **SINGER** machines can only be assured if **SINGER** parts and needles are used. Supplies are available at all **SINGER** Agencies for the Manufacturing Trade.

<p>SINGER Needles should be used in SINGER Machines. These Needles and their Containers are marked with the Trade Mark SIMANCO.*</p>	1
---	----------

<p>Needles in Containers marked "<u>For Singer Machines</u>" are <u>not</u> SINGER made needles.</p>	2
---	----------