

SINGER

24-71

INSTRUCTIONS

FOR USING AND ADJUSTING

SINGER SEWING MACHINE

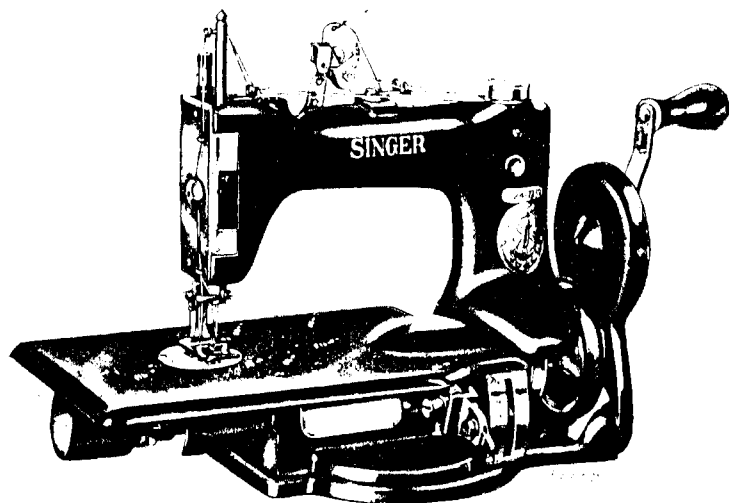

24-71

TWO NEEDLES AND TWO LOOPERS
SINGLE THREAD CHAIN STITCH

THE SINGER MANUFACTURING CO.

To all whom it may concern:

The placing or renewal of the name "Singer" (Reg. U. S. Pat. Off.) or any of the trade marks of The Singer Manufacturing Company on any machine that has been repaired, rebuilt, reconditioned or altered in any way whatsoever outside a Singer factory or an authorized Singer agency is forbidden.

Purchasing of Parts and Needles

Supplies of parts and needles for Singer machines can be purchased at any Singer Shop for the Manufacturing Trade or ordered by mail. If orders are sent by mail, money or a post office order covering their value, including postage, should be enclosed and the order will then be promptly filled and forwarded by mail or express.

Genuine Singer Needles should be used
in Singer Machines.
These Needles and their Containers
are marked with the
Company's Trade Mark "SIMANCO." 1

Needles in Containers marked
"For Singer Machines"
are not Singer made needles. 2

DESCRIPTION

Machine 24-71 has two needles and two loopers and makes the single thread chain stitch. It is furnished with a hand attachment and is especially adapted for sewing marking tape or tags on articles to be laundered.

Needles

Needles for Machine 24-71 are of Class and Variety 24x13 and are furnished in size 14.

Orders for needles must specify the *quantity* required, the *size*, and the *class* and *variety* numbers separated by the letter x.

The following is an example of an intelligible order:

"50 No. 14, 24x13 Needles."

The best results will be obtained when using the needles furnished by the Singer Sewing Machine Company.

Thread

The size of thread to be used should be determined by the size of the needles. If rough or uneven thread is used, or if it passes with difficulty through the eyes of the needles, the successful use of the machine will be interfered with.

To Oil the Machine

To ensure easy running and prevent unnecessary wear of the parts which are in movable contact, the machine must be oiled

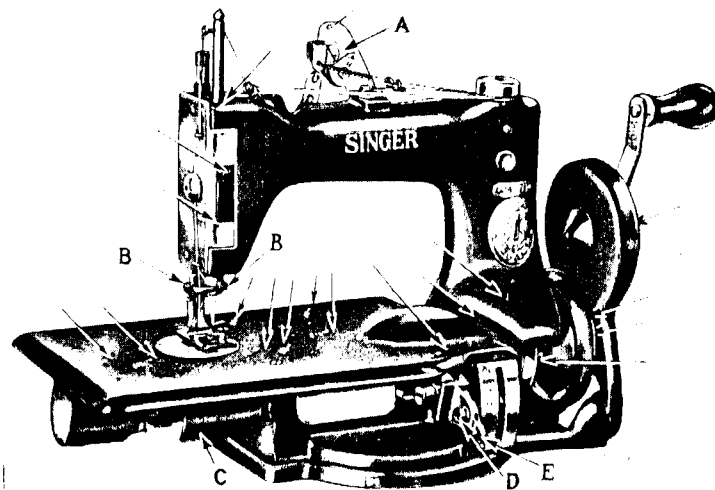

FIG. 2. FRONT VIEW OF MACHINE 24-71, SHOWING OILING POINTS AND ADJUSTMENTS

regularly. Apply oil to all oil holes and other places indicated by arrows in Figs. 2 and 3.

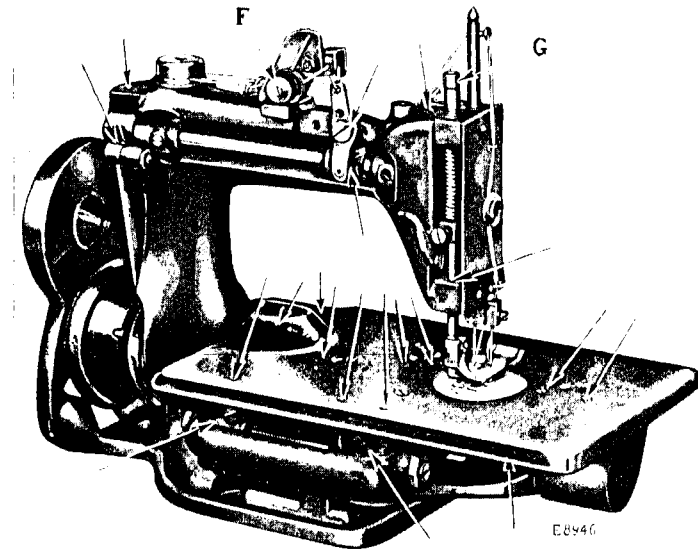

FIG. 3. OILING POINTS AND ADJUSTMENTS AT THE REAR OF THE MACHINE

To Set the Needles

Turn the hand crank until the needle bar is at its highest point. Loosen the two set screws (BB, Fig. 2) in the needle clamp and set the needles up into the clamp as far as they will go, with the eyes of the needles in line with the arm of the machine. The right or inside needle must have its long groove to the left, and the left or outside needle must have its long groove to the right. Then tighten the two set screws (BB).

To Thread the Machine

(SEE FIG. 4)

Pass the threads from the unwinder, from front to back through the hole (1) in the tension bracket, then separate the

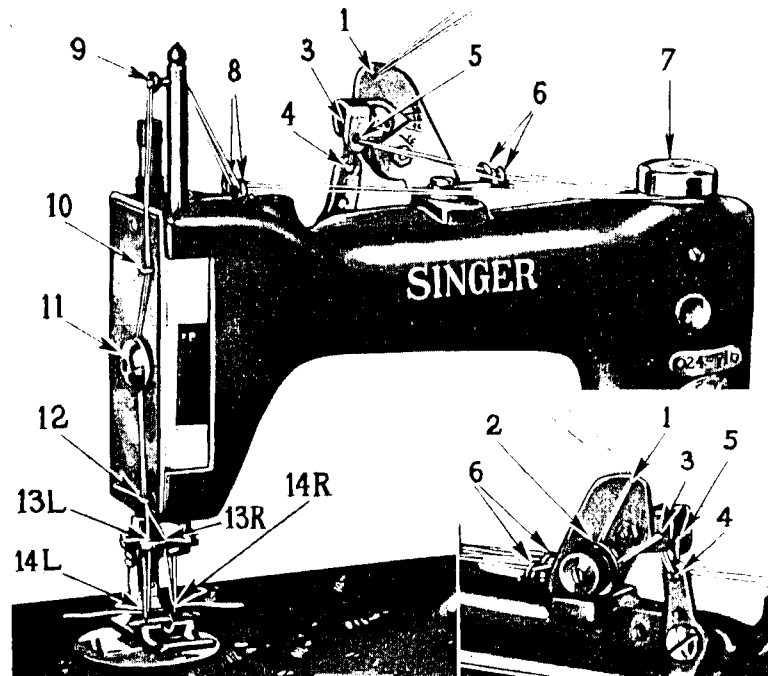

FIG. 4. THREADING THE MACHINE
(INSERT SHOWS REAR OF MACHINE)

threads and pass one under and between the first and second dials of the tension (2), and the other between the second and third dials (see insert); pass both threads from back to front through the rear eyelet (3) of the thread measuring device, from back to front through the hole (4) in the thread pull-off lever, from back to front through the front eyelet (5) of the thread measuring device, separately through the two wire thread eyelets (6), from back to front around under the nipper cap (7), separately through the two wire thread eyelets (8), from right to left through the tube (9) in the needle bar, down through thread

guide (10), back of thread retainer (11) and through guide (12) on the face plate, then separately through the two holes (13R and 13L) in the needle clamp. Pass the right-hand thread from left to right through the eye (14R) of the right-hand needle. Pass the left thread from right to left through the eye (14L) of the left needle. Allow about an inch and a half of thread to hang free from the eye of each needle with which to commence sewing.

When threading the machine, the two threads should be kept separate as much as possible to avoid their becoming twisted together.

Length of Stitch

To change the length of stitch, loosen locking screw (D, Fig. 2) and move the stitch regulator (E, Fig. 2) until the pointer in the slot of the stitch index plate is opposite the desired number of stitches to the inch. Tighten screw (D), then set the pointer (A, Fig. 2) of the thread measuring device at the corresponding number.

By setting the pointers on the thread measuring device and the stitch regulator index plate at the same figure, the exact amount of thread required for each stitch is pulled off. It will be noticed that the figures on the thread measuring device run only to 16, as it is not desirable to make more than this number of stitches to the inch for sewing on marking tags.

To Operate the Machine

Place the article under the presser foot, lower the presser foot and take three or four stitches, turning the hand crank away from you. Then insert the tape into the channel in the presser foot and push it under the needles. Stitch the tape in place and make three or four stitches beyond the tape, stopping the machine just before the needles have reached the goods on their downward stroke.

Now turn the balance wheel in the **reverse direction**, or over toward you, until the needles have just passed their highest point and the thread is still taut. This causes the knives which are attached to the loopers to enter the loops of thread on the loopers. Raise the presser foot and pull the goods away from you out of the machine, thus cutting the threads on the underside of the material. An end of thread of the correct length will be left in each needle with which to commence the stitching of the next tag.

Tension

The tension on the threads is regulated by turning the thumb nut (F, Fig. 3) at the rear of the tension discs inwardly for more tension, or outwardly for less tension. Only enough tension is required to make a smooth, flat stitch.

To Change the Pressure on the Material

The pressure of the presser foot on the material is regulated by turning the thumb screw (G, Fig. 3) at the top of the presser bar to the right to increase the pressure, or to the left to decrease the pressure. Only enough pressure is required to enable the feed to move the work along evenly.

Hints

The balance wheel and the hand crank should always turn over away from the operator when the machine is stitching.

Do not run the machine with the presser foot resting on the feed without cloth under the presser foot.

Do not run the machine with the needles threaded unless there is material under the presser foot.

Do not try to help the machine by pulling the work lest you bend the needles; the machine feeds the work without assistance.

If the thread becomes caught on the loopers, remove the looper cover (C, Fig. 2) underneath the cloth plate and clear away the thread, being careful not to scratch the loopers. Then replace the looper cover.

If the machine runs hard after standing idle for some time use a little kerosene in the oiling places, run the machine rapidly, then wipe clean and oil thoroughly.

If the machine skips stitches, see that the needles are correctly set and are not bent.

Breaking of thread may be due to improper threading, incorrect setting of the thread measuring device, tension too tight, bent or blunted needles, or the use of thread that is uneven or too coarse for the needles.

Breaking of needles may be caused by the presser foot being loose, by the needles being bent, by the loopers being set too close to the needles, or by pulling the work while stitching.

INSTRUCTIONS FOR ADJUSTERS AND MACHINISTS

To Set the Needle Bar at the Correct Height

The needle bar should be set so that when the points of the loopers have reached the centres of the needles on the upward

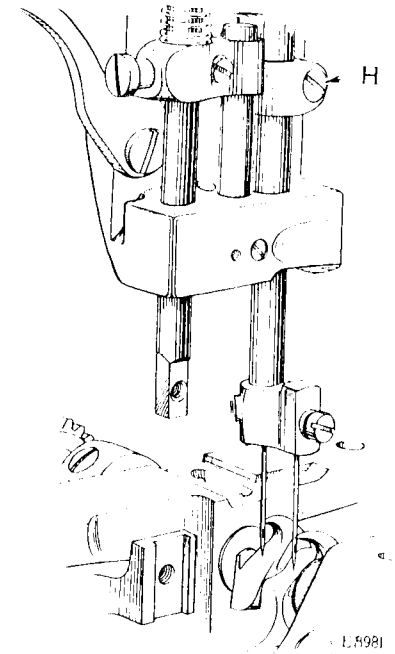

FIG. 5

stroke of the needle bar, as shown in Fig. 5, the eyes of the needles will be about $\frac{1}{16}$ inch below the points of the loopers. Be sure that the needles are set up into the needle clamp as far as they will go.

If the needle bar is not correctly set, loosen the clamping screw (H, Fig. 5) and move the needle bar up or down as required. Before tightening the clamping screw (H), see that the needles are in line with the needle holes in the throat plate.

To Time the Outside Looper

The left-hand looper should act in unison with the right-hand looper and the points of both loopers should reach the centres of the needles at the same time, as shown in Fig. 5.

To change the position of the left-hand looper, loosen the two set screws in the gear collar (P, Fig. 6) and turn this gear until the looper is in the correct position, then tighten the set screws.

To Remove the Loopers

(SEE FIG. 6)

To remove the loopers, first turn the balance wheel until the set screw (M) appears through the left-hand hole in the bed

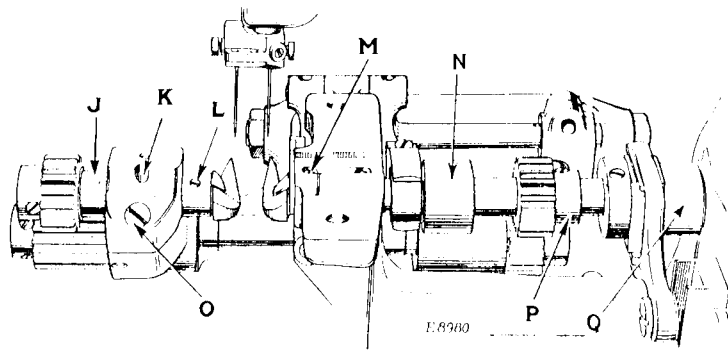

FIG. 6. ADJUSTMENTS UNDERNEATH THE BED PLATE

casting. Loosen this screw, also loosen set screw (L) which holds the left-hand looper in position. Now loosen clamping screw (O) and slide the bushing (J) to the left far enough to permit the loopers to be removed, one at a time, but not far enough to disengage the looper shaft gears.

When replacing the loopers, insert the shank of the right-hand looper into the rotary shaft with the flat of the shank toward the set screw (M). The point of the looper should come as close as possible to the needle without touching it. Then tighten set screw (M).

Insert the shank of the left-hand looper into the looper shaft as far as it will go, with the flat of the shank toward the set screw (L), then tighten the set screw. Slide the bushing (J) to the right until the point of the looper almost touches the needle, being careful to keep the slot in the bushing opposite the oil hole (K). Then securely tighten the clamping screw (O).

To Time the Feed

The feeding mechanism should be timed so that the feed dog begins its feeding movement (away from the operator) immediately after the needles leave the goods on their upward stroke, and finishes the feeding movement before the needles reach the goods on their downward stroke.

If it is necessary to time the feed, loosen the two set screws in the feed eccentric (Q, Fig. 6), also the two set screws in the feed lifting eccentric (N, Fig. 6). Hold the balance wheel with the needle bar at its lowest point, and turn the feed eccentric (Q) so that one set screw is at the top of the eccentric and the other is toward you. In this position the set screw which is toward you will be opposite a flat on the looper shaft. Tighten this screw against the flat, then tighten the screw at the top of the eccentric. Then set the feed lifting eccentric (N, Fig. 6) in exactly the same manner.

To Set the Thread Pull-off Lever

The thread pull-off lever (R, Fig. 7) should pull off just enough thread to make a smooth, flat stitch. To adjust the pull-off, see that the stitch regulator and the thread measuring device are set

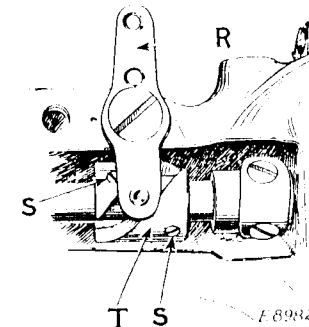

FIG. 7. ADJUSTMENT OF THREAD PULL-OFF LEVER

at the same figure as instructed on page 7, then loosen the two set screws (SS, Fig. 7). Turn cam (T, Fig. 7) so that the upper end of the pull-off lever (R) moves further toward the needle bar for a looser stitch, or further away from the needle bar for a tighter stitch. When the cam is correctly set, tighten the two screws (SS).

To Adjust the Thread Nipper

The automatic thread nipper should open enough to allow the thread to be pulled through freely and should close and nip the

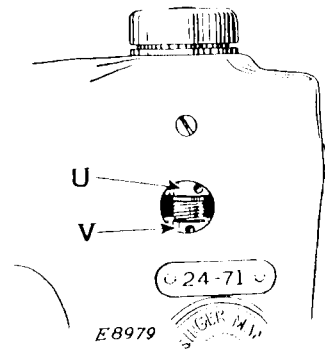

FIG. 8. ADJUSTMENT OF THREAD NIPPER

thread just as the needle bar reaches its highest point. To change the adjustment of the thread nipper, remove the plug screw in the arm just below the nipper cap, and turn the balance wheel until the nipper rises, bringing the nipper adjusting stud lock nut (V, Fig. 8) into view. Loosen this lock nut, then lower the nipper and turn the adjusting stud (U, Fig. 8) to the right to make the nipper close earlier, or to the left to make the nipper open further and close later. Then tighten the lock nut (V) and replace the plug screw in the arm.

To Raise or Lower the Feed Dog

The feed dog should be set so that when it is at its highest point, practically the full depth of the teeth projects through the slots in the throat plate. To set the feed dog, loosen the screw which holds it in position and raise or lower it as required, then securely tighten the screw.

Genuine Singer Needles should be used
in Singer Machines.
These Needles and their Containers
are marked with the
Company's Trade Mark "SIMANCO." 1

Needles in Containers marked
"For Singer Machines"
are not Singer made needles. 2