

Form 19676  
(441)  
Printed in U. S. A.

HISTORICAL COPY  
DO NOT REMOVE

# LIST OF PARTS



FOR FAMILY SHOPS

MACHINE No. 128-8

---

THE SINGER MANUFACTURING COMPANY

# INDEX

	Page
Accessory.....	12
Attachment Set.....	12
Bias Gauge.....	12
Bobbin Winder.....	13
Braider.....	13
Chart for Series B.S. Motors.....	9
Controllers (Convertible for Foot or Knee Control).....	11
Corder Bow.....	13
Feed Cover Plate.....	14
Feller (Foot).....	14
Finger Guard.....	14
Hemmers (Foot).....	14
Hemstitcher.....	14
Machine No. 128-8.....	5
Motor Parts.....	9
Needle Threader (Universal).....	15
Numerical List of Parts.....	19
Presser Feet.....	15
Presser Foot with Graduated Adjustable Guides.....	15
Quilter.....	16
Ruffler Shirring Plate.....	16
Spotlight.....	11
Spotlight Lamp.....	12
Special Attachments.....	17
Under Braider.....	16

## INSTRUCTIONS FOR ORDERING

5

In ordering from this list, use ONLY the part NUMBER in the FIRST column.

The number stamped on a Sewing Machine Part is in every case the number of the single part only.

Every combination of parts sent out as such has its specific number, which, although not stamped on the parts, must be used when ordering the combination.

Each number always indicates the SAME PART in whatever list it appears, or for whatever machine.

The letters after some of the numbers indicate the style of finish only, as follows:

A-Hardened, Polished, Nickel Plated and Buffed  
 A.A-Buffed and Chromium Plated  
 A.B-Hardened, Polished, Buffed and Chromium Plated  
 A.C-Brown Baking Enamel Finish  
 A.D-Gray Baking Enamel Finish  
 A.E-Hardened, Bright Rumbled and Nickel Plated  
 A.F-Hardened, Bright Rumbled, Nickel Plated, Bright Rumbled and Chromium Plated

B-Polished, Nickel Plated and Buffed  
 C-Hardened Only

C.R-Hardened and Merlized

D-Polished Only

E-Soft, Not Polished

F-Hardened and Polished

F.J-Hardened, Polished and Nickel Plated

G-Bright Rumbled and Nickel Plated

H-Blued

J-Nickel Plated Only

K-Hardened and Nickel Plated

L-Brass Plated

M-Oxidized

N-Japanned, Dull

P-Japanned, Bright

P.P-Wrinkle Finish

R-Merlized

S-Cadmium Plated

T-Copper Plated

T.A-Hardened, Polished, Copper and Nickel Plated and Buffed

T.B-Copper and Nickel Plated and Polished

T.J-Copper and Nickel Plated Only

T.K-Hardened, Copper and Nickel Plated

T.L-Copper and Brass Plated

T.M-Copper Plated and Oxidized

U-Zinc Plated

V-Silver Plated

W-Polished and Nickel Plated

X-Black Oxide, for Iron and Steel

X.C-Hardened and Black Oxide, for Iron or Steel

Y-Black Nickel Plated Only

Z-Chromium Plated

Z.A-Hardened, Polished, Nickel Plated, Buffed and Chromium Plated

Z.B-Polished, Nickel Plated, Buffed and Chromium Plated

Z.C-Hardened and Chromium Plated

Z.D-Polished and Chromium Plated

Z.G-Bright Rumbled, Nickel Plated, Bright Rumbled and Chromium Plated

Z.J-Nickel and Chromium Plated

Z.T-Copper and Chromium Plated

These letters MUST BE USED when they appear in the list; and AFTER the number as in the list.

In this series:

1 to 1500, 50001 to 51500 and 140001 to 142000 are Screw Numbers

1501 to 1800 and 51501 to 51900 are Nut Numbers

1801 to 2000 and 51901 to 52000 are Roller Numbers

2001 to 50000 and 52001 to 140000 and 142001 to

190000 are Sewing Machine Parts, 190001 and upward

are numbers of Electrical Parts.

The figures in the second column refer only to the plates, illustrating the parts, and are NOT TO BE USED in ordering.

Parts marked with an asterisk (\*) are furnished only when repairs are made at factory.

## LIST OF PARTS COMPLETE

FOR

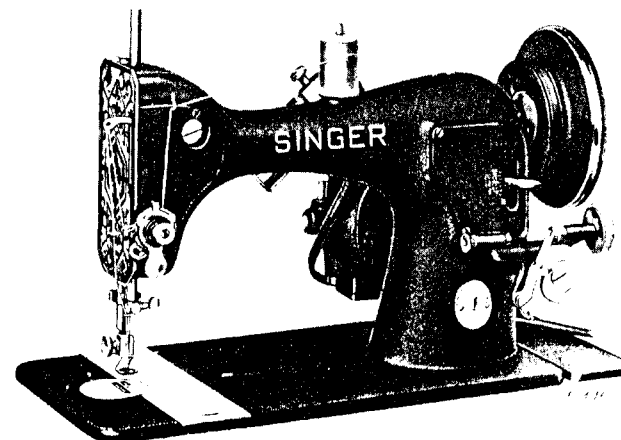

## MACHINE No. 128-8

FOR FAMILY USE.  
 DROP FEED MACHINE.

LOCK STITCH.  
 VIBRATING SHUTTLE.

No.	Plate	Name
*54531	----	Arm with 45773 and two 15405.....
2002	6419	" Dowel Pin (2).....
54532	6419	" Rock Shaft with 122E.....
54533	----	" " " 54532 with 520C and 1520J
122E	6419	" " " Adjusting Screw.....
8396	6419	" " " Center (upper).....
301C	6419	" " " Screw Center.....
55516	----	" " " " " 301C with 1508J.....
1508J	6419	Arm Rock Shaft Screw Center Nut.....
138E	6419	" Screw (3).....
8446	6419	" Shaft.....
54528	----	" " 8446 with 2117, 8206 and 55523
8206	6419	" " Bushing.....
443AL	6419	" " " Set Screw.....
54535	6419	" Side Cover (left) with 8422.....
402R	6419	" " " " Screw (lower).....
219R	6419	" " " " " (upper).....
8422	6419	" " " " Thread Guard.....
54534	6419	" " " (right).....

## PARTS FOR MACHINE No. 128-8

No.	Plate	Name
219R	6419	Arm Side Cover (right) Screw (2).....
2007	6419	" Spool Pin.....
54536PP	6419	Balance Wheel (disc) 2 3/4 in. diam. pulley.....
*54537	-----	Bed.....
55515	6420	" Oil Hole (shuttle) Packing.....
256B	6419	Clamp Stop Motion Clamp Screw.....
248A	6419	" " " " Stop Screw.....
2020	6419	" " " " Washer.....
15313	6419	" " " Flanged Bushing with two 462AL.....
462AL	6419	Clamp Stop Motion Flanged Bushing Set Screw (2).....
54538	6420	Face Plate.....
54539	-----	" " 54538 with 2827.....
219A	6420	" " Screw (2).....
125422	6420	" " Thread Guard.....
2827	-----	" " " 125422 with 8505
8505	6420	" " " Rivet.....
32562	6419	Feed Cam with 1285C.....
1285C	6419	" " Set Screw.....
8213	6420	" Dog, 11 teeth (15 teeth to the inch) for 8240.....
8437	6419	Feed Dog Carrier.....
1833	6419	" " Roller and Screw Stud..
315C	6419	" " Screw Center (2).....
15445	-----	" " " 315C with 1519J (2).....
1519J	6419	Feed Dog Carrier Screw Center Nut (2)..
191E	6420	" " Screw.....
8443	6419	" Forked Connection.....
54521	-----	" " " 8443 with 1832..
1381C	6419	" " " Hinge Screw (ec- centric).....
1520J	6419	Feed Forked Connection Hinge Screw Nut..
1832	6419	" " " Roller with 1085E
1085E	6419	" " " Screw Stud
54540	6419	" Regulator.....
54541	6419	" " Friction Spring.....
140261AL	6419	" " " Screw....
8431	6419	" Rock Shaft.....
307C	6419	" " " Screw Center (2).....
56814	-----	" " " 307C with 1513J (2).....
1513J	6419	Feed Rock Shaft Screw Center Nut (2)...
51045AL	6419	Machine Hinge Connection Set Screw (2).
54561	6421	Needle Bar.....
54542	6421	" " Cam with 175E and 400K.....
175E	6421	" " " Clamping Screw.....
400K	6421	" " " Guide Adjusting Screw....

## PARTS FOR MACHINE No. 128-8

No.	Plate	Name
233E	6421	Needle Bar Cam Position Screw.....
1836	6419	" " " Roller and Screw Stud....
8338	6421	" " " Thread Guard.....
249A	6421	" " " and Needle Stop Screw.....
2054	6421	Needle Clamp with 552C.....
552C	6421	" " Thumb Screw.....
54543	6421	Presser Bar.....
54546	6421	" " Guide Bracket with 453AL....
453AL	6421	" " " Set Screw.....
54544	6421	" " Lifter.....
54545	6421	" " " Hinge Pin.....
54547	6421	" " Spring.....
2070	6421	" " " Washer.....
15281	6421	" Foot.....
51224B	6421	" " Thumb Screw.....
51228B	6421	Pressure Regulating Thumb Screw.....
8444	6419	Shuttle Bell Crank.....
54523	-----	" " " 8444 with 50036E....
50036E	6419	" " " Hinge Screw.....
8228	6420	" Bobbin.....
54548	6420	" Body.....
215H	6420	" Tension Regulating Screw.....
8326	6420	" " Spring.....
54549	6420	Shuttle complete, Nos. 215H, 8228, 8326 and 54548.....
54550	6420	Shuttle Carrier.....
54551	6420	" " 54550 with 54552 and two 54509.....
54552	6420	Shuttle Carrier Cushion Spring.....
54509	6420	" " " Rivet (2)
231K	6420	" " Screw.....
8445	6419	" Pitman.....
44C	6419	" " Hinge Screw.....
520C	6419	" " Screw Stud (eccentric)...
216K	6419	" " " " Cap Screw.....
1520J	6419	Shuttle Pitman Screw Stud (eccentric) Nut.....
54512	6420	Shuttle Slide (back).....
54513	6420	" " (front).....
2102	6420	Tension Disc (2).....
51687B	6420	" Regulating Thumb Nut.....
8237	6420	" Releaser.....
8238	6420	" Spring.....
140262W	6420	" Stud.....
54553	-----	" " 140262W with 51687B.....
1125AL	6420	" " Set Screw.....
54554	6420	Tension complete, Nos. 8237, 8238, 54553, 54557 and two 2102.....

No.	Plate	Name
26075	6421	Thread Cutter and Holder.....
*55523	-----	" Take-up Cam.....
55521	6419	" " " 55523 with two 448AL (for Agents only).....
2117	-----	Thread Take-up Cam Pin.....
448AL	6419	" " " Set Screw (2).....
54555	6421	" " Lever with 1822.....
54556	6421	" " " 54555 with 140263A.....
140263A	6421	" " " Hinge Screw.....
1822	6421	" " " Roller and Stud....
54557	6420	" " Spring.....
54558	6420	" " " Regulator Plate with 54559 and 54560.....
337B	6420	Thread Take-up Spring Regulator Plate Adjusting Screw.....
54559	6420	Thread Take-up Spring Regulator Plate Cushion (leather).....
54560	6420	Thread Take-up Spring Regulator Plate Cushion Rivet.....
8240	6420	Throat Plate for 8213.....
219A	6420	" " Screw.....
*45773	-----	Trade Mark.....
15405	-----	" " Rivet (2).....

**Genuine Singer Needles should be used  
in Singer Machines.  
These Needles and their Containers  
are marked with the  
Company's Trade Mark "SIMANCO." 1**

**Needles in Containers marked  
"For Singer Machines"  
are not Singer made needles. 2**

### CHART FOR SERIES B. S. MOTORS

Motor Catalog No.	Volts	Cycles	Amperes
B.S. 3	32	D.C. only	1.5
B.S. 5	50	D.C. and 25 to 75 Cycles A.C.	1.0
B.S. 6	95-100	"	.70
B.S. 7	100-110	"	.65
B.S. 8	115-125	"	.60
B.S. 9	150-165	"	.50
B.S. 10	200-220	"	.40
B.S. 11	210-230	"	.35
B.S. 12	230-250	"	.35
B.S. 15	130-145	"	.55
B.S. 87	100-110	D.C. and 80 to 100 Cycles A.C.	.75
B.S. 90	200-220	"	.50
B.S. 92	230-250	"	.45

### MOTOR PARTS

No.	Plate	Name
194291	6422	Armature complete for B.S. 3 Motor.....
		Armature complete for B.S. 5 Motor.....
		Armature complete for B.S. 6 and B.S. 7 Motors.....
		Armature complete for B.S. 8 Motor.....
		Armature complete for B.S. 9 Motor.....
		Armature complete for B.S. 10 and B.S. 92 Motors.....
		Armature complete for B.S. 11 and B.S. 12 Motors.....
		Armature complete for B.S. 14 Motor.....
		Armature complete for B.S. 15 Motor.....
		Armature complete for B.S. 87 Motor.....
		Armature complete for B.S. 92 Motor.....
		190304
190073	-----	Armature Shaft Grease Cup Body (2).....
190074	6422	" " " " Wick (2).....

## MOTOR PARTS

No.	Plate	Name
190075	6422	Armature Shaft Grease Cup Wick Spring (2).....
190606	-----	Armature Shaft Grease Cup complete, Nos. 190073 to 190075 (2).....
191097	6422	Armature Thrust Washer (commutator end) fibre.....
191098	6422	Armature Thrust Washer (pulley end) peerless paper.....
193066	6422	Belt (moulded).....
190782	-----	Brush (carbon) for 32 to 55 volts (2)..
192947	6422	" " " 150 to 250 volts (2).
192930	6422	" Cap (2).....
190083	6422	" Spring (2).....
190079	6422	" Tube (2).....
192901	6422	" " Insulation (bakelite) (2)...
50518C	6422	" " Set Screw (2).....
190059	6422	Commutator complete.....
195014	6422	End Cover (commutator end).....
195015	6422	" " (pulley end).....
50517R	6422	" " Screw (2).....
		Field Coil complete for B.S. 3 Motor....
		Field Coil complete for B.S. 5 Motor....
		Field Coil complete for B.S. 6 Motor....
195010	6422	Field Coil complete for B.S. 7 Motor....
		Field Coil complete for B.S. 8 Motor....
		Field Coil complete for B.S. 9 Motor....
		Field Coil complete for B.S. 10 and B.S. 11 Motors.....
		Field Coil complete for B.S. 12 Motor...
		Field Coil complete for B.S. 14 Motor...
		Field Coil complete for B.S. 15 Motor...
		Field Coil complete for B.S. 87 Motor...
		Field Coil complete for B.S. 90 Motor...
		Field Coil complete for B.S. 92 Motor...
190563	6422	" " Retainer (2).....
192240	-----	" " Tube (paper) 1/8 in. (2)....
192243	-----	" " " 3/16 in. (2)....
*195013	6422	Field Core complete.....
195025	6422	" " Shield with 991035 and two 36648, for B.S. 7 Motor.....
195036	-----	Field Core Shield with 899676 and two 36648, for all B.S. Motors except B.S. 7.....
335B	6422	Field Core Shield Screw (2).....
50632CR	6422	Motor Screw.....
190058	6422	" " Retaining Washer.....
191417	6422	" " Washer.....
*991035	-----	Name Plate for B.S. 7 Motor.....
*899676	-----	" " " all B.S. Motors except B.S. 7.....
36648	-----	Name Plate Rivet (2).....

## MOTOR PARTS

No.	Plate	Name
193754	6422	Pulley with 460AL.....
460AL	6422	" Set Screw.....
195027	6422	Terminal Box.....
195017	6422	" " Cover.....
140274CR	6422	" " " Screw (2).....
195031	6422	" " Insulation.....
140273R	6422	" " Screw (2).....
190613	6422	Tube filled with Singer Motor Lubricant (packed in carton).....

## CONTROLLERS

## CONVERTIBLE FOR FOOT OR KNEE CONTROL

No.	Plate	Name
195019	-----	Controller complete, convertible for Foot or Knee Control, for 32 to 55 volts, A.C. or D.C. Motors, Nos. 194717, 195022, 899915 and two 36648
195020	6423	Controller complete, convertible for Foot or Knee Control, for 95 to 145 volts, A.C. or D.C. Motors, Nos. 194717, 195022, 991036 and two 36648
195021	-----	Controller complete, convertible for Foot or Knee Control, for 150 to 250 volts, A.C. or D.C. Motors, Nos. 194717, 195022, 899915 and two 36648
*195022	6423	Controller Lead (from Controller to Terminal Box).....
194711	6423	Controller Lead Bushing (black fibre)...
194712	6423	" " " Clip.....
194717	6423	" " " Strain Relief.....
*991036	-----	" Name Plate for 195020.....
*899915	-----	" " " 195019 and 195021.....
36648	-----	Controller Name Plate Rivet (2).....

## SPOTLIGHT

No.	Plate	Name
195037	6423	Spotlight with Lead and Plug.....
195004	6423	" Bracket with 140186B.....
140186B	6423	" " Clamping Screw.....
195018	6423	Spotlight (less lamp) complete, Nos. 51326B, 97359, 195004 and 195037....
51326B	6423	Spotlight Screw.....
97359	6423	" " Retaining Washer.....

## SPOTLIGHT LAMP

No.	Plate	Name
194242	6423	Spotlight Lamp.....

Note: When ordering No.194242, state voltage required.

## ACCESSORY

No.	Plate	Name
120862	6424	Oil Can, contents 1 1/3 fl. oz. (filled with household oil).....

## ATTACHMENT SET

No.	Plate	Name
121461	23901	Binder Folder.....
121463	23901	" Foot.....
51104B	23901	" Screw.....
120565	23901	" " Washer.....
121464	23901	Binder complete, Nos. 51104B, 120565, 121461 and 121463.....
8228	23901	Bobbin (four).....
36865	23901	Edge Stitcher.....
35931	23901	Hemmer (adjustable).....
120842	23901	" (foot) 5/64 in. hem.....
-----	-----	Needle (six).....
121441	23901	Presser Foot (double toe) for gathering.....
25537	23901	Screw Driver (machine).....
120378	23901	" " (shuttle tension).....
8879	23901	Spool Pin Washer (cloth).....
121900	-----	Attachment Set Nos. 8879, 25537, 35931, 36865, 120378, 120842, 121441, 121464, four 8228 and six needles.....
120598	23901	Ruffler for one, six and twelve stitch ruffling.....
121901	23901	Attachment Set complete, Nos. 120598 and 121900.....

## BIAS GAUGE

No.	Plate	Name
25525	6424	Bias Gauge.....

## BOBBIN WINDER

(AUTOMATIC)

No.	Plate	Name
8255	23902	Back Center.....
8256	23902	" " Head.....
8250	23902	" " Spring.....
*8257	23902	Cam.....
50231A	23902	" Screw.....
8258	23902	Frame.....
2460	23902	Friction Ring (rubber).....
8371	23902	Pulley.....
540A	23902	Spindle.....
8259	23902	Thread Guide.....
92B	23902	" " Hinge Screw.....
8260	23902	" " Spring.....
8261	23902	Worm Wheel.....
55514	23902	" " 8261 with 8257 and 50231A....
2749	23902	" " Friction Washer.....
50B	23902	" " Screw Stud (eccentric).....
1528J	23902	" " " " Nut.....
8370	23902	Bobbin Winder (automatic) complete, Nos. 50B, 92B, 540A, 1528J, 2460, 2749, 8250, 8255, 8256, 8258 to 8260, 8371 and 55514.....
136A	23902	Bobbin winder Hinge Screw.....

## BRAIDER

No.	Plate	Name
25510	9698	Braider.....
289B	9698	" Thumb Screw.....

## CORDER BOW

FOR TOP CORDING

No.	Plate	Name
26399	23902	Corder (bow) complete.....
190J	23902	" Screw.....

## FEED COVER PLATE

No.	Plate	Name
8335	6424	Feed Cover Plate with 1423B and 8336....
8336	6424	" " " Position Stud.....
1423B	6424	" " " Screw.....

## FELLER (Foot)

No.	Plate	Name
36835	9698	Feller (foot).....

## FINGER GUARD

No.	Plate	Name
121725	9698	Finger Guard.....

## HEMMERS (Foot)

No.	Plate	Name
25904	6424	Hemmer (foot) 1/16 in. hem.....
36333	6424	" " 1/16 in. hem, for chiffon and silk.....
36469	6424	Hemmer (foot) 1/32 in. hem, for chiffon and silk (slotted for lace).....
120842	23901	Hemmer (foot) 5/64 in. hem.....
25911	6424	" " 3/32 in. hem.....
25895	6424	" " 1/8 in. hem.....
35884	9698	" " 3/16 in. hem.....
25893	9698	" " 1/4 in. hem.....

## HEMSTITCHER

No.	Plate	Name
120687	9698	Hemstitcher with Yielding Presser Plate.

## NEEDLE THREADER (Universal)

No.	Plate	Name
121632	6424	Needle Threader (universal).....
121631	6424	" " Hook.....
140157J	6424	" " " Screw.....

PRESSER FOOT WITH GRADUATED  
ADJUSTABLE GUIDES

No.	Plate	Name
121717	6424	Presser Foot with 36696.....
35002	6424	" " Extension.....
35003	6424	" " Graduated Adjustable Guide (long, left).....
35004	6424	Presser Foot Graduated Adjustable Guide (long, right).....
35005	6424	Presser Foot Graduated Adjustable Guide (short, right).....
35006	6424	Presser Foot Graduated Adjustable Guide (short, right) flush.....
35135	6424	Presser Foot Graduated Adjustable Guide Clamp.....
35206	6424	Presser Foot Graduated Adjustable Guide Clamp Lever.....
337J	6424	Presser Foot Graduated Adjustable Guide Clamp Screw.....
36696	6424	Presser Foot Graduated Adjustable Guide Clamp Steady Pin.....
121718	6424	Presser Foot with Extension and Gradu- ated Adjustable Guides complete, Nos. 337J, 35002 to 35006, 35135, 35206 and 121717.....

## PRESSER FEET

No.	Plate	Name
15429	9698	Presser Foot (left toe) for stitching on edge and inserting cord.....
125035	9698	Presser Foot (right toe) for stitching on edge and inserting cord.....
28831	6424	Presser Foot for darning.....



PRESSER FEET

No.	Plate	Name
121614	9698	Presser Foot with 51282J and 121615, for blind stitch braiding, for soutache braid.....
121615	9698	Presser Foot Braid Guide.....
Note: When ordering Nos. 121614 or 121615, send sample of braid for which it is required.		
51282J	9698	Presser Foot Braid Guide Screw.....
36058	9698	" " with 665B and 36059, for blind stitch cording, to turn small curves.....
36059	9698	Presser Foot Cord Guide.....
Note: When ordering Nos. 36058 or 36059, send sample of cord for which it is required.		
665B	9698	Presser Foot Cord Guide Screw.....
36067	9698	" " for braiding, for art work, for braid 1/16 in. to 3/16 in. wide.
Note: When ordering No. 36067, state the size or send a sample of the braid for which it is required.		
25978	9698	Presser Foot (single toe) for gathering.
121441	23901	" " (double toe) for gathering.

QUILTER

No.	Plate	Name
35932	9698	Quilter.....

RUFFLER SHIRRING PLATE

No.	Plate	Name
35934	23902	Ruffler Shirring Plate.....

UNDER BRAIDER

No.	Plate	Name
121547	6424	Under Braider.....
25637	6424	" " Foot.....
51395W	-----	" " Thumb Screw.....

SPECIAL ATTACHMENTS

FOR COMPONENT PARTS OF THESE ATTACHMENTS, REFER TO FORM 19385, LIST OF PARTS FOR SINGER FASHION AIDS.

No.	Plate	Name
121795	-----	Buttonhole Attachment complete.....
121094	-----	Darning Foot (spring) complete.....
26538	-----	Embroidery Attachment complete for one thread.....
35505	-----	Embroidery Attachment complete for two threads.....
121387	-----	Hemstitching and Picoting Attachment complete.....
121634	-----	Needle Threader and Seam Ripper complete
121255	-----	Singercraft Fagoter complete.....
121079	-----	Singercraft Guide complete.....
35985	-----	Tubular Trimming Attachment complete....
121706	-----	Zigzag Attachment (adjustable) complete.

Genuine Singer Needles should be used  
in Singer Machines.  
These Needles and their Containers  
are marked with the  
Company's Trade Mark "SIMANCO." 1

Needles in Containers marked  
"For Singer Machines"  
are not Singer made needles. 2

# NUMERICAL LIST OF PARTS

## NUMERICAL LIST OF PARTS

No.	Plate	Name
44C	6419	Shuttle Pitman Hinge Screw.....
50B	23902	Bobbin Winder Worm Wheel Screw Stud (eccentric) for 8370.....
92B	23902	Bobbin Winder Thread Guide Hinge Screw for 8370.....
122E	6419	Arm Rock Shaft Adjusting Screw for 54532
136A	23902	Bobbin Winder Hinge Screw.....
138E	6419	Arm Screw (3).....
175E	6421	Needle Bar Cam Clamping Screw for 54542.
190J	23902	Corder Screw.....
191E	6420	Feed Dog Screw.....
215H	6420	Shuttle Tension Regulating Screw for 54549.....
216K	6419	Shuttle Pitman Screw Stud (eccentric) Cap Screw.....
219R	6419	Arm Side Cover (left) Screw (upper).....
219R	6419	" " " (right) Screw (2).....
219A	6420	Face Plate Screw (2).....
219A	6420	Throat Plate Screw.....
231K	6420	Shuttle Carrier Screw.....
233E	6421	Needle Bar Cam Position Screw.....
248A	6419	Clamp Stop Motion Clamp Stop Screw.....
249A	6421	Needle Bar Thread Guard and Needle Stop Screw.....
256B	6419	Clamp Stop Motion Clamp Screw.....
289B	9698	Braider Thumb Screw.....
301C	6419	Arm Rock Shaft Screw Center for 55516...
307C	6419	Feed Rock Shaft Screw Center for 56814 (2).....
315C	6419	Feed Dog Carrier Screw Center for 15445 (2).....
335B	6422	Field Core Shield Screw (2).....
337J	6424	Presser Foot Graduated Adjustable Guide Clamp Screw for 121718.....
337B	6420	Thread Take-up Spring Regulator Plate Adjusting Screw.....
400K	6421	Needle Bar Cam Guide Adjusting Screw for 54542.....
402R	6419	Arm Side Cover (left) Screw (lower).....
443AL	6419	" Shaft Bushing Set Screw.....
448AL	6419	Thread Take-up Cam Set Screw for 55521 (2).....
453AL	6421	Presser Bar Guide Bracket Set Screw for 54546.....
460AL	6422	Pulley Set Screw for 193754.....
462AL	6419	Clamp Stop Motion Flanged Bushing Set Screw for 15313 (2).....

No.	Plate	Name
520C	6419	Shuttle Pitman Screw Stud (eccentric) for 54533.....
540A	23902	Bobbin Winder Spindle for 8370.....
552C	6421	Needle Clamp Thumb Screw for 2054.....
665B	9698	Presser Foot Cord Guide Screw for 36058.
1085E	6419	Feed Forked Connection Roller Screw Stud for 1832.....
1125AL	6420	Tension Stud Set Screw.....
1285C	6419	Feed Cam Set Screw for 32562.....
1381C	6419	" Forked Connection Hinge Screw (eccentric).....
1423B	6424	Feed Cover Plate Screw for 8335.....
1508J	6419	Arm Rock Shaft Screw Center Nut for 55516.....
1513J	6419	Feed Rock Shaft Screw Center Nut for 56814 (2).....
1519J	6419	Feed Dog Carrier Screw Center Nut for 15445 (2).....
1520J	6419	Feed Forked Connection Hinge Screw Nut..
1520J	6419	Shuttle Pitman Screw Stud (eccentric) Nut for 54533.....
1528J	23902	Bobbin Winder Worm Wheel Screw Stud Nut for 8370.....
1822	6421	Thread Take-up Lever Roller and Stud for 54555.....
1832	6419	Feed Forked Connection Roller with 1085E, for 54521.....
1833	6419	Feed Dog Carrier Roller and Screw Stud..
1836	6419	Needle Bar Cam Roller and Screw Stud....
2002	6419	Arm Dowel Pin (2).....
2007	6419	" Spool Pin.....
2020	6419	Clamp Stop Motion Clamp Washer.....
2054	6421	Needle Clamp with 552C.....
2070	6421	Presser Bar Spring Washer.....
2102	6420	Tension Disc for 54554 (2).....
2117	----	Thread Take-up Cam Pin for 54528.....
2460	23902	Bobbin Winder Friction Ring (rubber) for 8370.....
2749	23902	Bobbin Winder Worm Wheel Friction Washer for 8370.....
2827	----	Face Plate Thread Guard 125422 with 8505, for 54539.....
8206	6419	Arm Shaft Bushing for 54528.....
8213	6420	Feed Dog, 11 teeth (15 teeth to the inch) for 8240.....
8228	6420	Shuttle Bobbin for 54549 and 121900....
8237	6420	Tension Releaser for 54554.....
8238	6420	" Spring for 54554.....
8240	6420	Throat Plate for 8213.....
8250	23902	Bobbin Winder Back Center Spring for 8370.....

No.	Plate	Name
8255	23902	Bobbin Winder Back Center for 8370.....
8256	23902	" " " " Head for 8370.
*8257	23902	" " Cam for 55514.....
8258	23902	" " Frame for 8370.....
8259	23902	" " Thread Guide for 8370.....
8260	23902	" " " " Spring for 8370.....
8261	23902	Bobbin Winder Worm Wheel for 55514.....
8326	6420	Shuttle Tension Spring for 54549.....
8335	6424	Feed Cover Plate with 1423B and 8336....
8336	6424	" " " Position Stud for 8335.
8338	6421	Needle Bar Thread Guard.....
8370	23902	Bobbin Winder (automatic) complete, Nos. 50B, 92B, 540A, 1528J, 2460, 2749, 8250, 8255, 8256, 8258 to 8260, 8371 and 55514.....
8371	23902	Bobbin Winder Pulley for 8370.....
8396	6419	Arm Rock Shaft Center (upper).....
8422	6419	" Side Cover (left) Thread Guard for 54535.....
8431	6419	Feed Rock Shaft.....
8437	6419	" Dog Carrier.....
8443	6419	" Forked Connection for 54521.....
8444	6419	Shuttle Bell Crank for 54523.....
8445	6419	" Pitman.....
8446	6419	Arm Shaft for 54528.....
8505	6420	Face Plate Thread Guard Rivet for 2827..
8879	23901	Spool Pin Washer (cloth) for 121900....
15281	6421	Presser Foot.....
15313	6419	Clamp Stop Motion Flanged Bushing with two 462AL.....
15405	----	Trade Mark Rivet for 54531 (2).....
15429	9698	Presser Foot (left toe) for stitching on edge and inserting cord.....
15445	----	Feed Dog Carrier Screw Center 315C with 1519J (2).....
25510	9698	Braider.....
25525	6424	Bias Gauge.....
25537	23901	Screw Driver (machine) for 121900.....
25637	6424	Under Braider Foot.....
25893	9698	Hemmer (foot) 1/4 in. hem.....
25895	6424	" " 1/8 in. hem.....
25904	6424	" " 1/16 in. hem.....
25911	6424	" " 3/32 in. hem.....
25978	9698	Presser Foot (single toe) for gathering.
26075	6421	Thread Cutter and Holder.....
26399	23902	Corder (bow) complete.....
26538	----	Embroidery Attachment complete for one thread.....
28831	6424	Presser Foot for darning.....

## NUMERICAL LIST OF PARTS

No.	Plate	Name
32562	6419	Feed Cam with 1285C.....
35002	6424	Presser Foot Extension for 121718.....
35003	6424	" " Graduated Adjustable Guide (long, left) for 121718.....
35004	6424	Presser Foot Graduated Adjustable Guide (long, right) for 121718.....
35005	6424	Presser Foot Graduated Adjustable Guide (short, right) for 121718.....
35006	6424	Presser Foot Graduated Adjustable Guide (short, right) flush, for 121718....
35135	6424	Presser Foot Graduated Adjustable Guide Clamp for 121718.....
35206	6424	Presser Foot Graduated Adjustable Guide Clamp Lever for 121718.....
35505	-----	Embroidery Attachment complete for two threads.....
35884	9698	Hemmer (foot) 3/16 in. hem.....
35931	23901	Hemmer (adjustable) for 121900.....
35932	9698	Quilter.....
35934	23902	Ruffler Shirring Plate.....
35985	-----	Tubular Trimming Attachment complete....
36058	9698	Presser Foot with 665B and 36059 for blind stitch cording, to turn small curves.....
36059	9698	Presser Foot Cord Guide for 36058.....
36067	9698	" " for braiding, for art work, for braid 1/16 in. to 3/16 in. wide.
36333	6424	Hemmer (foot) 1/16 in. hem, for chiffon and silk.....
36469	6424	Hemmer (foot) 1/32 in. hem, for chiffon and silk (slotted for lace).....
36648	-----	Controller Name Plate Rivet for 195019 to 195021 (2).....
36648	-----	Name Plate Rivet for 195025 and 195036 (2).....
36696	6424	Presser Foot Graduated Adjustable Guide Clamp Steady Pin for 121717.....
36835	9698	Feller (foot).....
36865	23901	Edge Stitcher for 121900.....
*45773	-----	Trade Mark for 54531.....
50036E	6419	Shuttle Bell Crank Hinge Screw for 54523
50231A	23902	Bobbin Winder Cam Screw for 55514.....
50517R	6422	End Cover Screw (2).....
50518C	6422	Brush Tube Set Screw (2).....
50632CR	6422	Motor Screw.....
51045AL	6419	Machine Hinge Connection Set Screw (2).
51104B	23901	Binder Screw for 121464.....
51224B	6421	Presser Foot Thumb Screw.....
51228B	6421	Pressure Regulating Thumb Screw.....
51282J	9698	Presser Foot Braid Guide Screw for 121614.....

## NUMERICAL LIST OF PARTS

No.	Plate	Name
51326B	6423	Spotlight Screw for 195018.....
51395W	-----	Under Braider Thumb Screw for 121547....
51687B	6420	Tension Regulating Thumb Nut for 54553..
54509	6420	Shuttle Carrier Cushion Spring Rivet for 54551 (2).....
54512	6420	Shuttle Slide (back).....
54513	6420	" " (front).....
54521	-----	Feed Forked Connection 8443 with 1832... Shuttle Bell Crank 8444 with 50036E.....
54523	-----	Arm Shaft 8446 with 2117, 8206 and 55523
54528	-----	" with 45773 and two 15405.....
*54531	-----	" Rock Shaft with 122E, for 54533.....
54532	6419	" " " 54532 with 520C and 1520J
54533	-----	" Side Cover (right).....
54534	6419	" " " (left) with 8422.....
54535	6419	Balance Wheel (disc) 2 3/4 in. diam. pulley.....
54536PP	6419	Bed.....
*54537	-----	Face Plate for 54539.....
54538	6420	" " 54538 with 2827.....
54539	-----	Feed Regulator.....
54540	6419	" " Friction Spring.....
54541	6419	Needle Bar Cam with 175E and 400K.....
54542	6421	Presser Bar.....
54543	6421	" " Lifter.....
54544	6421	" " Hinge Pin.....
54545	6421	" " Guide Bracket with 453AL....
54546	6421	" " Spring.....
54547	6421	Shuttle Body for 54549.....
54548	6420	Shuttle complete, Nos. 215H, 8228, 8326 and 54548.....
54549	6420	Shuttle Carrier for 54551.....
54550	6420	" " 54550 with 54552 and two 54509.....
54551	6420	Shuttle Carrier Cushion Spring for 54551 Tension Stud 140262W with 51687B, for 54554.....
54552	6420	Tension complete, Nos. 8237, 8238, 54553, 54557 and two 2102.....
54553	-----	Thread Take-up Lever with 1822, for 54556.....
54554	6420	Thread Take-up Lever 54555 with 140263A.
54555	6421	" " Spring for 54554.....
54556	6421	" " Regulator Plate with 54559 and 54560.....
54557	6420	Thread Take-up Spring Regulator Plate Cushion (leather) for 54558.....
54558	6420	Thread Take-up Spring Regulator Plate Cushion Rivet for 54558.....
54559	6420	Needle Bar.....
54560	6420	
54561	6421	

No.	Plate	Name
55514	23902	Bobbin Winder Worm Wheel 8261 with 8257 and 50231A, for 8370.....
55515	6420	Bed Oil Hole (shuttle) Packing.....
55516	-----	Arm Rock Shaft Screw Center 301C with 1508J.....
55521	6419	Thread Take-up Cam 55523 with two 448AL (for Agents only).....
*55523	-----	Thread Take-up Cam for 54528 and 55521..
56814	-----	Feed Rock Shaft Screw Center 307C with 1513J (2).....
97359	6423	Spotlight Screw Retaining Washer for 195018.....
120378	23901	Screw Driver (shuttle tension) for 121900.....
120565	23901	Binder Screw Washer for 121464.....
120598	23901	Ruffler for one, six and twelve stitch ruffling for 121901.....
120687	9698	Hemstitcher with Yielding Presser Plate.
120842	23901	Hemmer (foot) 5/64 in. hem, for 121900..
120862	6424	Oil Can, contents 1 1/3 fl. oz. (filled with household oil).....
121079	-----	Singercraft Guide complete.....
121094	-----	Darning Foot (spring) complete.....
121255	-----	Singercraft Fagoter complete.....
121387	-----	Hemstitching and Picoting Attachment complete.....
121441	23901	Presser Foot (double toe) for gathering for 121900.....
121461	23901	Binder Folder for 121464.....
121463	23901	" Foot for 121464.....
121464	23901	Binder complete for 121900, Nos. 51104B, 120565, 121461 and 121463.....
121547	6424	Under Braider.....
121614	9698	Presser Foot with 51282J and 121615, for blind stitch braiding for soutache braid.....
121615	9698	Presser Foot Braid Guide for 121614.....
121631	6424	Needle Threader Hook for 121632.....
121632	6424	" " (universal).....
121634	-----	Needle Threader and Seam Ripper complete
121706	-----	Zigzag Attachment (adjustable) complete.
121717	6424	Presser Foot with 36696, for 121718.....
121718	6424	Presser Foot with Extension and Graduated Adjustable Guides complete, Nos. 337J, 35002 to 35006, 35135, 35206 and 121717.....
121725	9698	Finger Guard.....
121795	-----	Buttonhole Attachment complete.....
121900	-----	Attachment Set for 121901, Nos. 8879, 25537, 35931, 36865, 120378, 120842, 121441, 121464, four 8228 and six needles.....

No.	Plate	Name
121901	23901	Attachment Set complete, Nos. 120598 and 121900.....
125035	9698	Presser Foot (right toe) for stitching on edge and inserting cord.....
125422	6420	Face Plate Thread Guard for 2827.....
140157J	6424	Needle Threader Hook Screw for 121632...
140186B	6423	Spotlight Bracket Clamping Screw for 195004.....
140261AL	6419	Feed Regulator Friction Spring Screw....
140262W	6420	Tension Stud for 54553.....
140263A	6421	Thread Take-up Lever Hinge Screw for 54556.....
140273R	6422	Terminal Box Screw (2).....
140274CR	6422	" " Cover Screw (2).....
190058	6422	Motor Screw Retaining Washer.....
190059	6422	Commutator complete.....
190073	-----	Armature Shaft Grease Cup Body for 190606 (2).....
190074	6422	Armature Shaft Grease Cup Wick for 190606 (2).....
190075	6422	Armature Shaft Grease Cup Wick Spring for 190606 (2).....
190079	6422	Brush Tube (2).....
190083	6422	" Spring (2).....
190304	6422	Armature Shaft Bearing Sleeve Cap (commutator end).....
190563	6422	Field Coil Retainer (2).....
190606	-----	Armature Shaft Grease Cup complete, Nos. 190073 to 190075 (2).....
190613	6422	Tube filled with Singer Motor Lubricant (packed in carton).....
190782	-----	Brush (carbon) for 32 to 55 volts (2)..
191097	6422	Armature Thrust Washer (commutator end) fibre.....
191098	6422	Armature Thrust Washer (pulley end) peerless paper.....
191417	6422	Motor Screw Washer.....
192240	-----	Field Coil Tube (paper) 1/8 in. (2)....
192243	-----	" " " " 3/16 in. (2)...
192901	6422	Brush Tube Insulation (bakelite) (2)...
192930	6422	" Cap (2).....
192947	6422	" (carbon) for 150 to 250 volts (2)
193066	6422	Belt (moulded).....
193754	6422	Pulley with 460AL.....
194242	6423	Spotlight Lamp.....
194291	6422	Armature complete for B.S. 6 and B.S. 7 Motors.....
194711	6423	Controller Lead Bushing (black fibre)...
194712	6423	" " " Clip.....
194717	6423	" " " Strain Relief for 195019 to 195021.....

No.	Plate	Name
195004	6423	Spotlight Bracket with 140186B, for 195018.....
195010	6422	Field Coil complete for B.S. 7 Motor....
*195013	6422	Field Core complete.....
195014	6422	End Cover (commutator end).....
195015	6422	" " (pulley end).....
195017	6422	Terminal Box Cover.....
195018	6423	Spotlight (less lamp) complete, Nos. 51326B, 97359, 195004 and 195037....
195019	-----	Controller complete, convertible for Foot or Knee Control, for 32 to 55 volts, A.C. or D.C. Motors, Nos. 194717, 195022, 899915 and two 36648..
195020	6423	Controller complete, convertible for Foot or Knee Control, for 95 to 145 volts, A.C. or D.C. Motors, Nos. 194717, 195022, 991036 and two 36648..
195021	-----	Controller complete, convertible for Foot or Knee Control, for 150 to 250 volts, A.C. or D.C. Motors, Nos. 194717, 195022, 899915 and two 36648..
*195022	6423	Controller Lead (from Controller to Terminal Box) for 195019 to 195021.....
195025	6422	Field Core Shield with 991035 and two 36648, for B.S. 7 Motor.....
195027	6422	Terminal Box.....
195031	6422	" " Insulation.....
195036	-----	Field Core Shield with 899676 and two 36648, for all B.S. Motors except B.S. 7.....
195037	6423	Spotlight with Lead and Plug for 195018.
*899676	-----	Name Plate for 195036, for all B.S. Motors, except B.S. 7.....
*899915	-----	Controller Name Plate for 195019 and 195021.....
*991035	-----	Name Plate for 195025, for B.S. 7 Motor.
*991036	-----	Controller Name Plate for 195020.....

## ILLUSTRATIONS OF PARTS





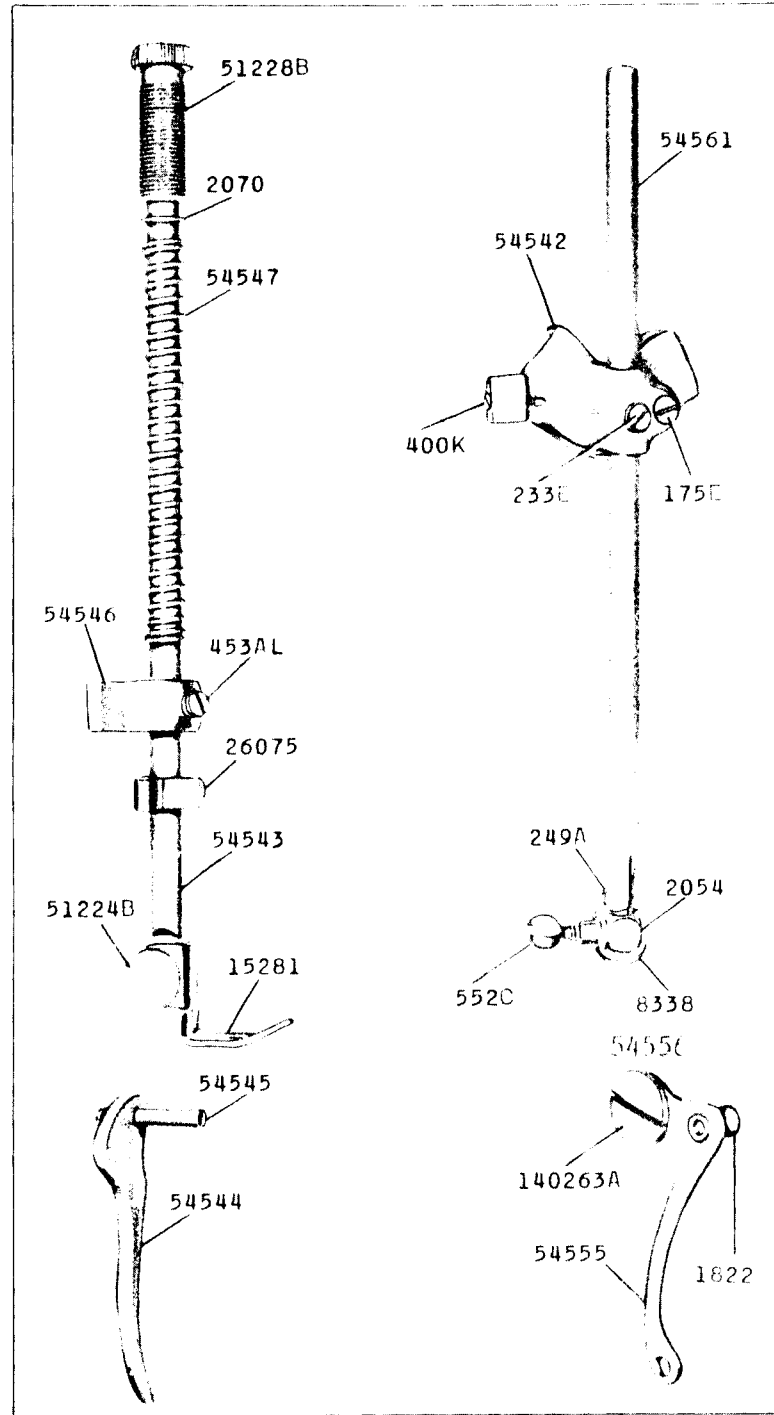
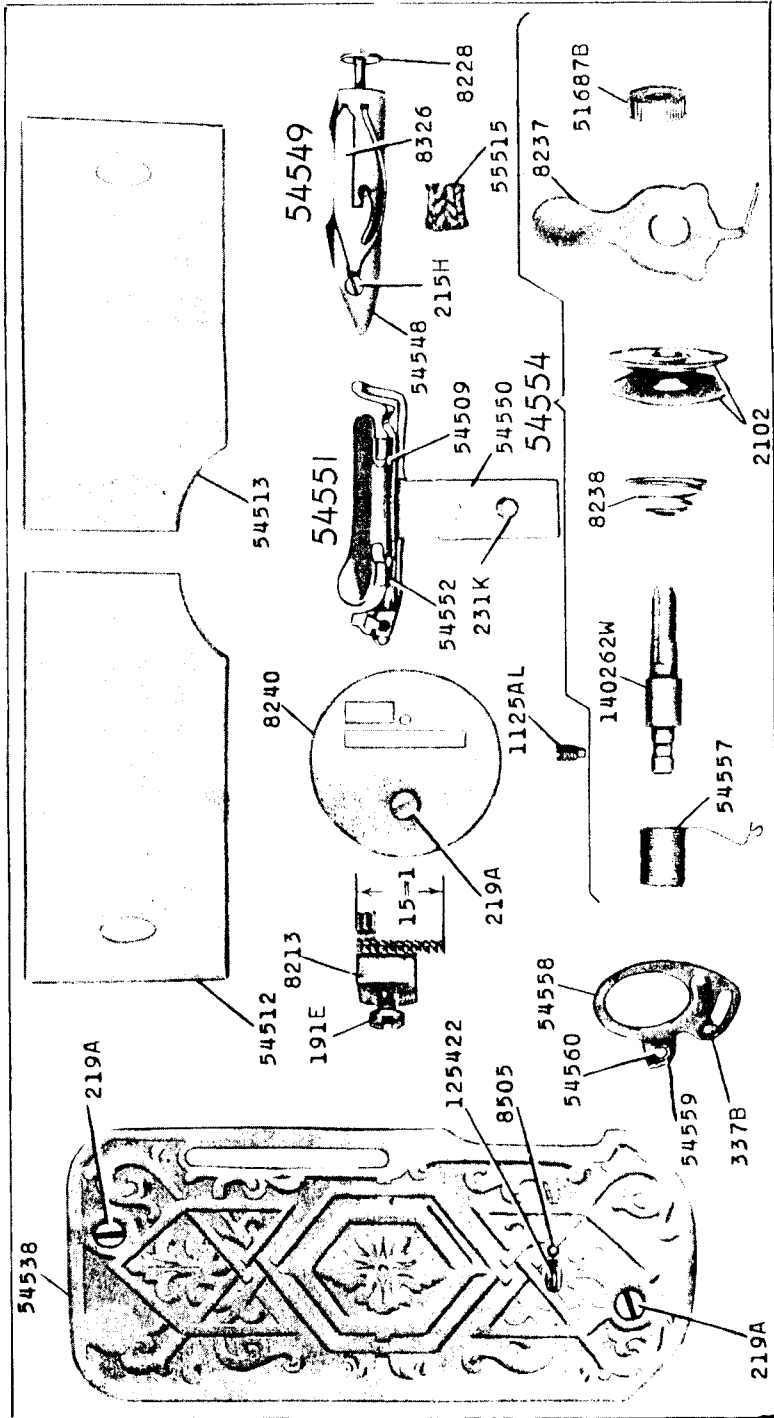

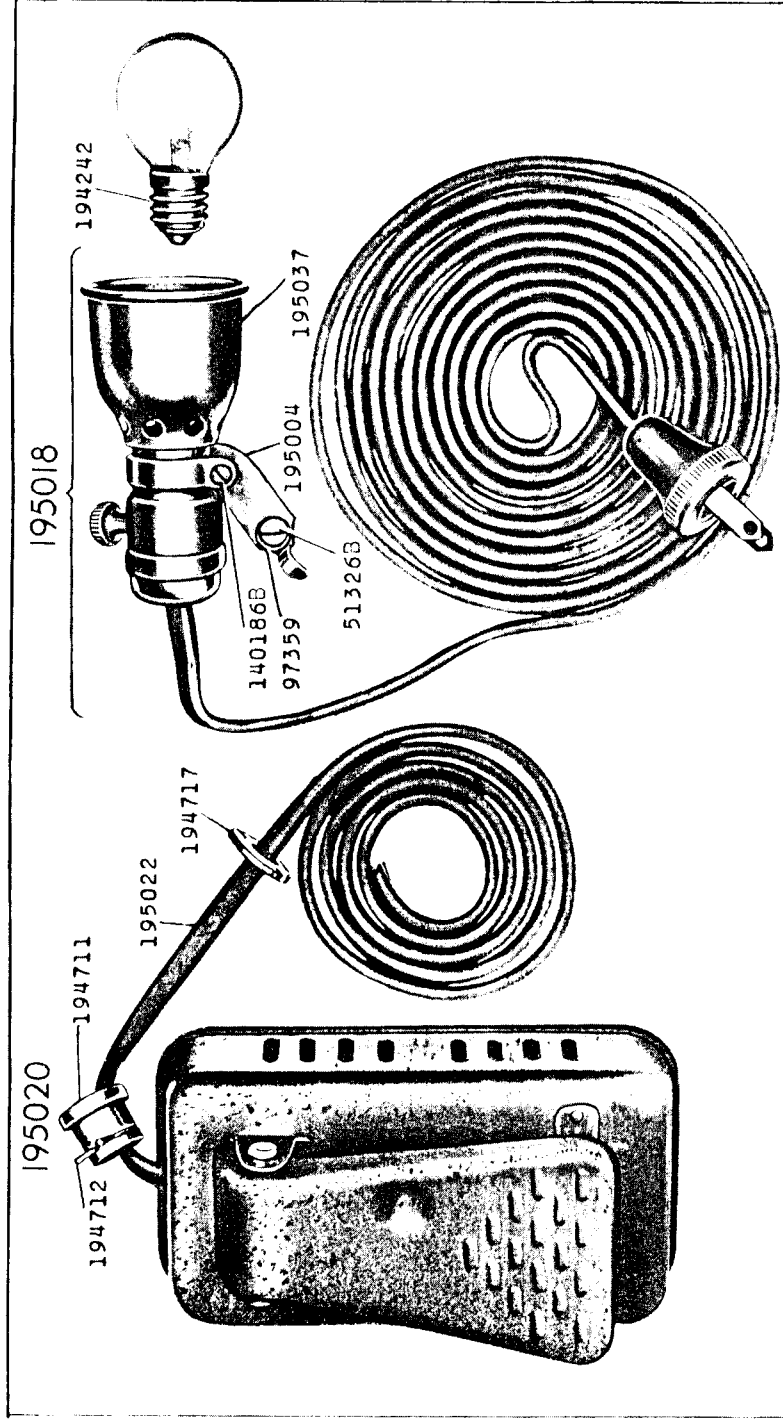
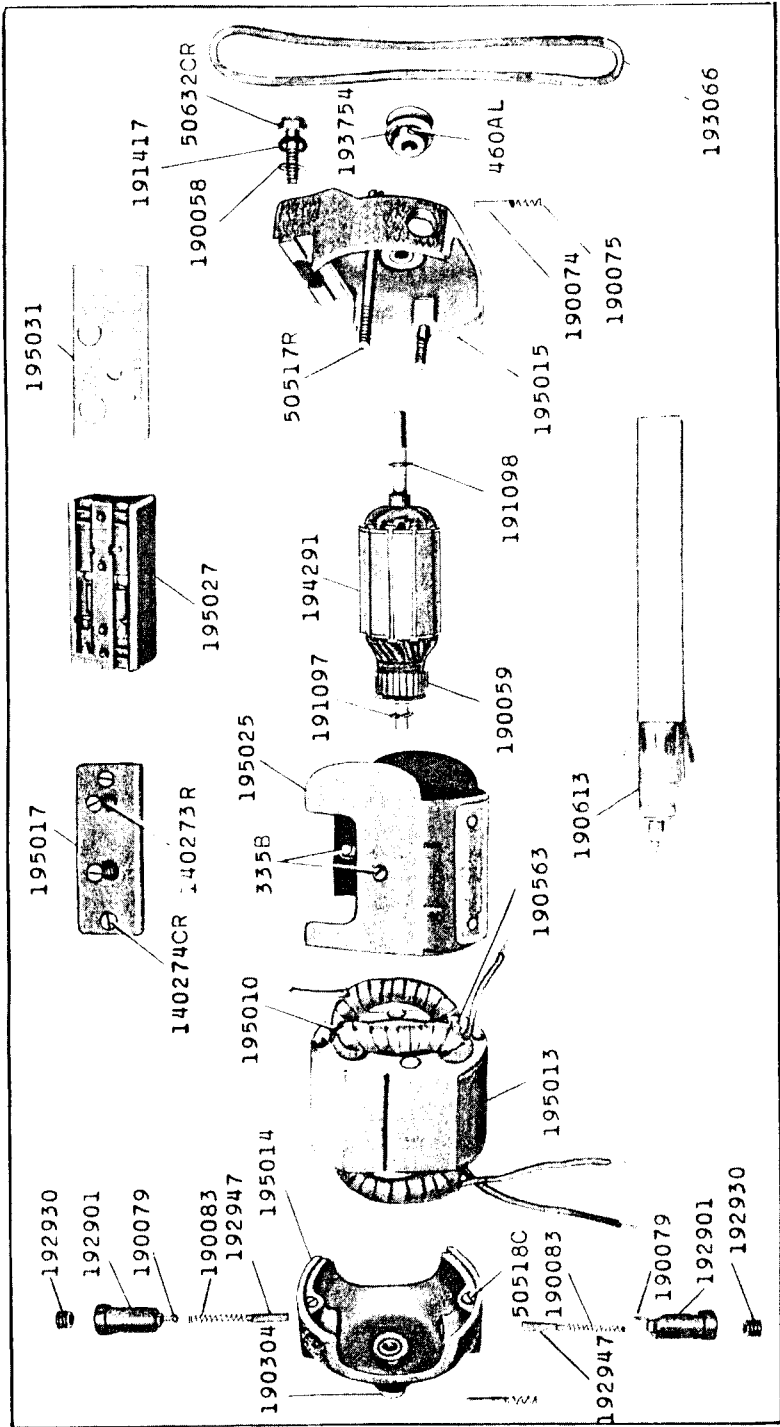

6424 - 1/2

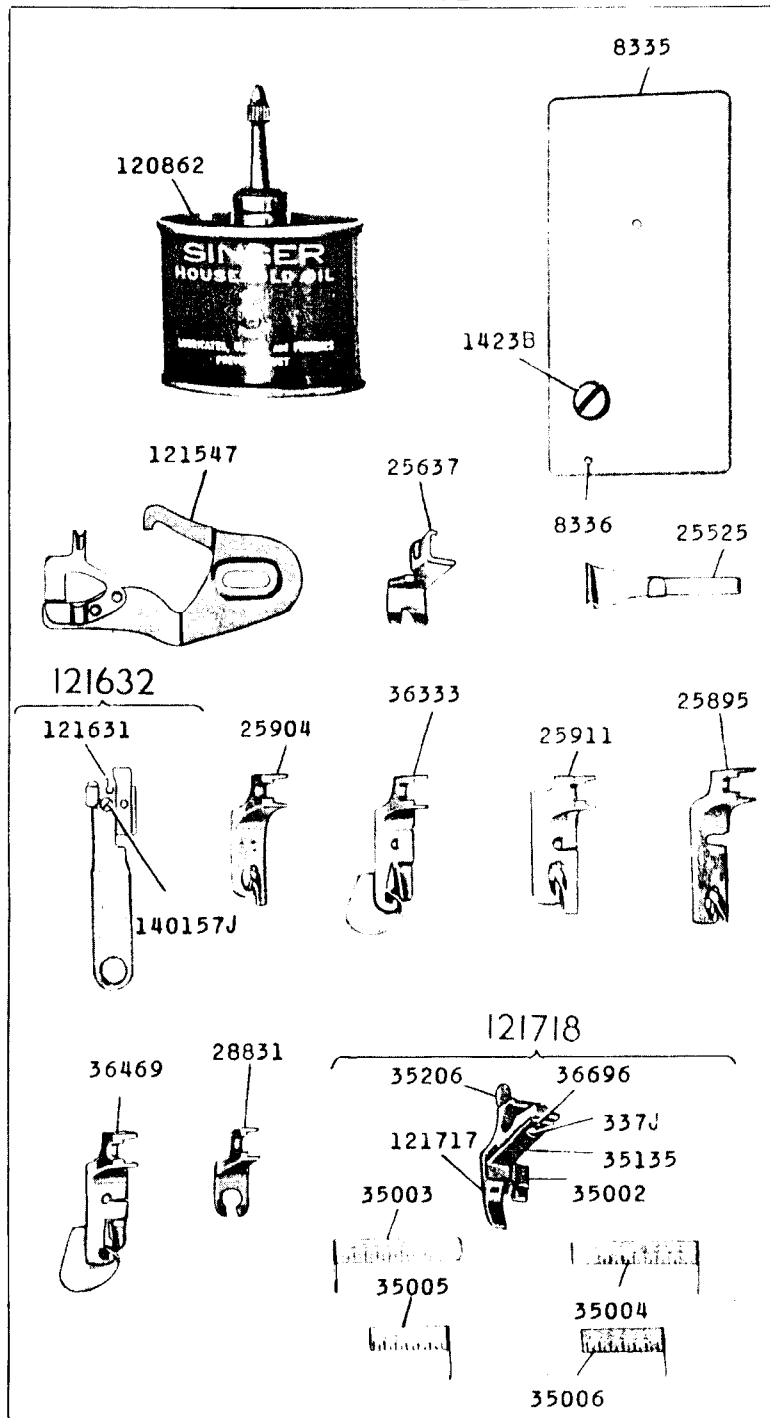

9698 - 2/3

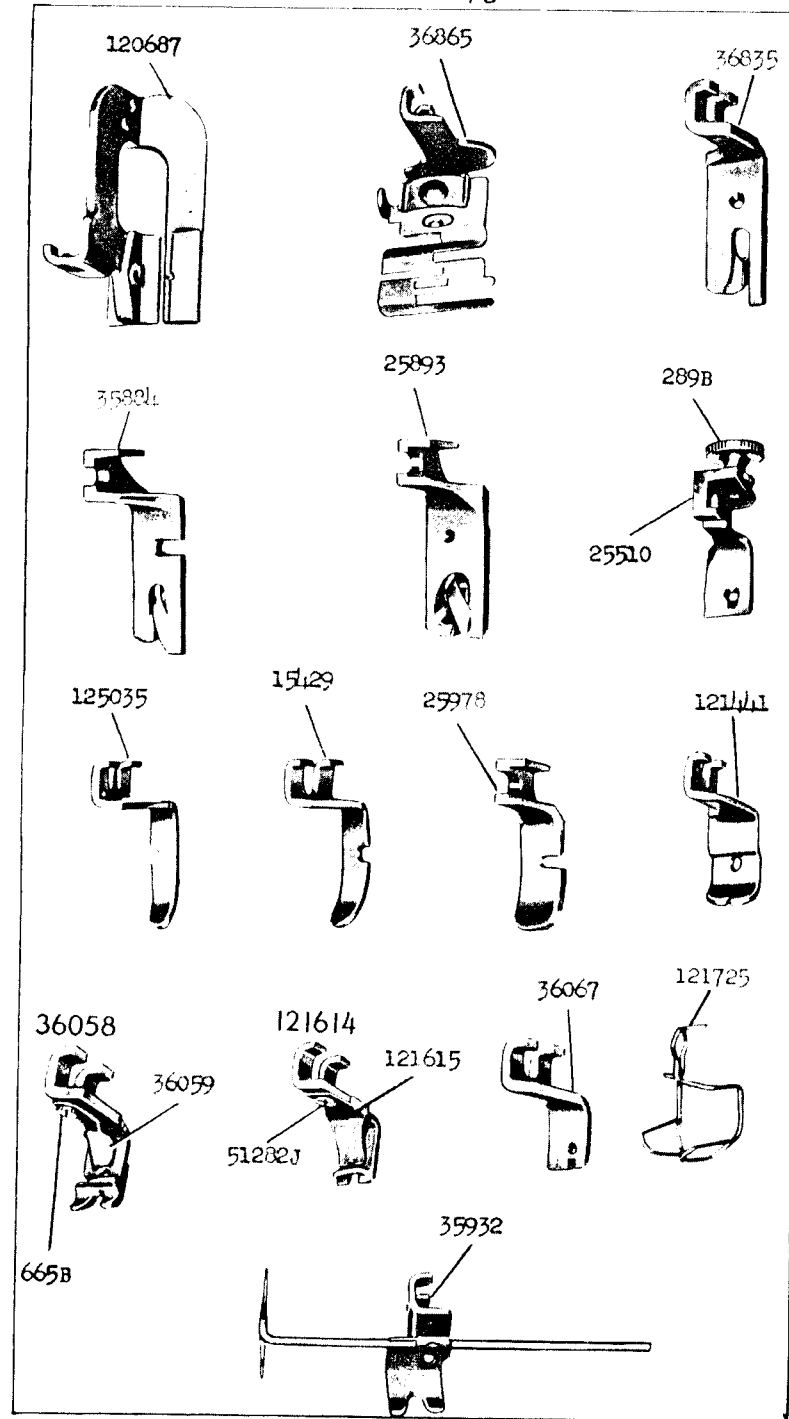

23901 - 1/2

121901

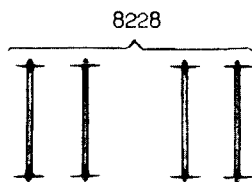
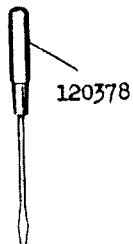
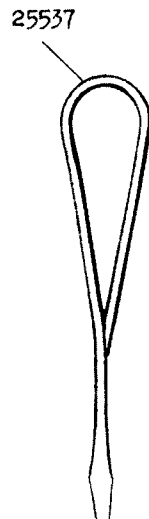
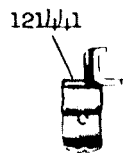
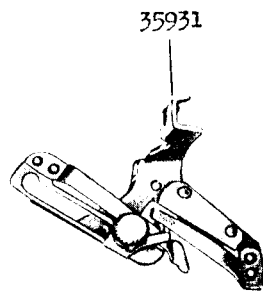
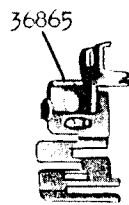
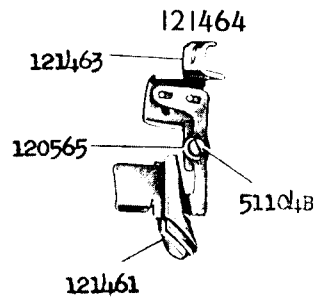
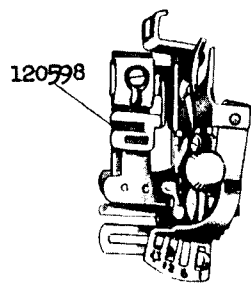

23902 - 2/3

8370

