

Form 19421

(140)

Printed in U. S. A.

LIST OF PARTS



SINGER** MACHINES

Nos. 114-39 and 114-41

THE SINGER MANUFACTURING COMPANY

**A Trade Mark of THE SINGER MANUFACTURING COMPANY

INSTRUCTIONS FOR OILING

To ensure easy running and prevent unnecessary wear of the parts which are in movable contact, the machine requires oiling and when in continuous use, "TYPE B" or "TYPE D" OIL, sold by Singer Sewing Machine Company, should be applied at least twice each day to all oil holes marked "OIL", as instructed in Form 8428.

"TYPE D" OIL should be used when an oil is desired which will produce a minimum of stain on fabrics, even after a long period of storage.

Copyright, U. S. A., 1936 and 1940,
by The Singer Manufacturing Company
All Rights Reserved for all Countries

INDEX

	Page
Attachments and Accessories	18
Eye and Finger Guard.....	19
Foot Lifter Parts.....	20
Machine No. 114-39.....	5
Machine No. 114-41.....	17
Numerical List of Parts.....	23
Starting Lever.....	20
Table Belt Guide.....	21
Thread Unwinder.....	21

In ordering from this list, use ONLY the part NUMBER in the FIRST column.

The number stamped on a Sewing Machine Part is in every case the number of the single part only.

Every combination of parts sent out as such has its specific number, which, although not stamped on the parts, must be used when ordering the combination.

Each number always indicates the SAME PART in whatever list it appears, or for whatever machine.

The letters after some of the numbers indicate the style of finish only, as follows:

- A-Hardened, Polished, Nickel Plated and Buffed
- A.A-Buffed and Chromium Plated
- A.B-Hardened, Polished, Buffed and Chromium Plated
- A.C-Brown Baking Enamel Finish
- A.D-Gray Baking Enamel Finish
- A.E-Hardened, Bright Rumbled and Nickel Plated
- A.F-Hardened, Bright Rumbled, Nickel Plated, Bright Rumbled and Chromium Plated
- B-Polished, Nickel Plated and Buffed
- C-Hardened Only
- C.R-Hardened and Merlized
- D-Polished Only
- E-Soft, Not Polished
- F-Hardened and Polished
- F.J-Hardened, Polished and Nickel Plated
- G-Bright Rumbled and Nickel Plated
- H-Blued
- J-Nickel Plated Only
- K-Hardened and Nickel Plated
- L-Brass Plated
- M-Oxidized
- N-Japanned, Dull
- P-Japanned, Bright
- P.P-Wrinkle Finish
- R-Merlized
- S-Cadmium Plated
- T-Copper Plated
- T.A-Hardened, Polished, Copper and Nickel Plated and Buffed
- T.B-Copper and Nickel Plated and Polished
- T.J-Copper and Nickel Plated Only
- T.K-Hardened, Copper and Nickel Plated
- T.L-Copper and Brass Plated
- T.M-Copper Plated and Oxidized
- U-Zinc Plated
- V-Silver Plated
- W-Polished and Nickel Plated
- X-Black Oxide, for Iron and Steel
- X.C-Hardened and Black Oxide, for Iron or Steel
- Y-Black Nickel Plated Only
- Z-Chromium Plated
- Z.A-Hardened, Polished, Nickel Plated, Buffed and Chromium Plated
- Z.B-Polished, Nickel Plated, Buffed and Chromium Plated
- Z.C-Hardened and Chromium Plated
- Z.D-Polished and Chromium Plated
- Z.G-Bright Rumbled, Nickel Plated, Bright Rumbled and Chromium Plated
- Z.J-Nickel and Chromium Plated
- Z.T-Copper and Chromium Plated

These letters MUST BE USED when they appear in the list; and AFTER the number as in the list.

In this series:

- 1 to 1500, 50001 to 51500 and 140001 to 142000 are Screw Numbers
- 1501 to 1800 and 51501 to 51800 are Nut Numbers
- 1801 to 2000 and 51801 to 52000 are Roller Numbers
- 2001 to 50000 and 52001 to 140000 and 142001 to 190000 are Sewing Machine Parts, 190001 and upward are numbers of Electrical Parts.

The figures in the second column refer only to the plates, illustrating the parts, and are NOT TO BE USED in ordering.

Parts marked with an asterisk (*) are furnished only when repairs are made at factory.

LIST OF PARTS COMPLETE
FOR

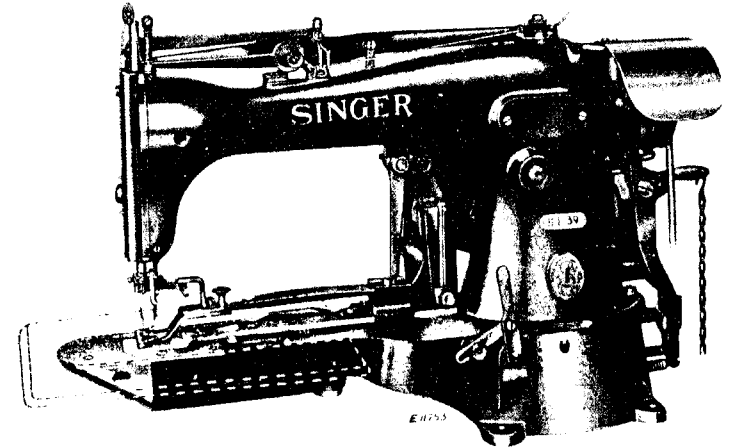

MACHINE No. 114-39

For Tacking Paper Tickets on Clothing to Distinguish Lot, Color, Size, etc., while in process of Manufacture. Trapezoidal tack, 9 stitches, base away from operator. Thread cutter, leaves long end to unravel when detaching ticket. Speed 1500 R. P. M.

No.	Plate	Name
*124845	----	Arm.....
62295	----	" 124845 with 4449, 15404, 124793 and two each 164E and 15405.....
16532	9594	Arm Dowel Pin.....
4448	9594	" Oil Tube for intermediate bearing...
56015	9594	" " " oiling 59705 and 59706.
880E	9594	" Screw.....
59702	9594	" Shaft (horizontal).....
17703	9594	" " " Bushing (back)....
50333C	9594	" " " " " Ad-justing Screw.....
1520J	9594	Arm Shaft (horizontal) Bushing (back) Adjusting Screw Nut.....
*4449	----	Arm Shaft (horizontal) Bushing (front)..

No.	Plate	Name
59703	9594	Arm Shaft (horizontal) Gear with two 1036C.....
1036C	9594	Arm Shaft (horizontal) Gear Set Screw...
59704	9594	" " (upright).....
59705	9594	" " " Bushing (lower)....
446C	9594	" " " " " Set Screw.....
59706	9594	Arm Shaft (upright) Bushing (upper)....
446C	9594	Arm Shaft (upright) Bushing (upper) Set Screw.....
59707	9594	Arm Shaft (upright) Gear (lower) with two 1253C.....
1253C	9594	Arm Shaft (upright) Gear (lower) Set Screw.....
59708	9594	Arm Shaft (upright) Gear (upper) with two 1253C.....
1253C	9594	Arm Shaft (upright) Gear (upper) Set Screw.....
124674	9594	Arm Side Cover.....
190J	9594	" " " Screw.....
18498	9594	Belt Cover.....
59795	9594	" " Bracket with 184E and 59796..
184E	9594	" " " Screw Stud.....
59796	9594	" " " Stud.....
217J	9594	" " Screw.....
39222	23153	" Shifter.....
63976	23153	" " Clamp.....
1255D	23153	" " " Screw.....
124712	9596	Brake.....
124713	-----	" 124712 with four 56493.....
124714	9596	" Adjusting Plate.....
124715	9596	" " " Handle.....
124716	-----	" " " " 124715 with 124717.....
50435J	9596	Brake Adjusting Plate Handle Hinge Screw
124717	9596	" " " " Shaft.....
124718	9596	" " " " " Crank with 1253C.....
1253C	9596	Brake Adjusting Plate Handle Shaft Crank Set Screw.....
51224W	9596	Brake Adjusting Plate Thumb Screw.....
124719	9596	" " " " " Bushing
124720	9596	" Arm.....
1403D	9596	" " Hinge Screw.....
124902	23153	" " Releasing Lever.....
124901	-----	" " " " 124902 with 124903 and two 792C.....
124903	23153	Brake Arm Releasing Lever Bracket.....
792C	23153	" " " " " Screw.
50446D	9596	" Hinge Screw.....
56493	9596	" Pad (leather).....

No.	Plate	Name
124846	9596	Brake Spring.....
136557	9597	Clamp with 1220E and 17928.....
62258	9597	" " Arm with 17714.....
62259	-----	" " 62258 with 62260 and two 201D.
17710	9597	" " Hinge Plate.....
1176D	9597	" " " " Screw.....
62260	9597	" " Hook.....
201D	9597	" " " Screw.....
62261	23151	" Lifter.....
190J	23151	" " Screw.....
124711	23154	" Locking Device Latch with two 1057J.....
1057J	23154	Clamp Locking Device Latch Clamping Screw.....
124678	23154	Clamp Locking Device Latch Shaft.....
124696	-----	" " " " " 124678 with 124679 and 124823.....
124679	23154	Clamp Locking Device Latch Shaft Crank..
124680	23154	" " " " " " Connection.....
1282C	23154	Clamp Locking Device Latch Shaft Crank Connection Hinge Screw (lower).....
1282C	23154	Clamp Locking Device Latch Shaft Crank Connection Hinge Screw (upper).....
124823	23154	Clamp Locking Device Latch Shaft Crank Pin.....
17928	9597	Clamp Position Stud.....
17712	9597	" Pressure Spring.....
17713	9597	" " " Bracket.....
1177D	9597	" " " " " Screw....
17714	9597	" " " Guide Block.....
1178D	9597	" " " Screw.....
20437	9597	" " " " Washer.....
1220E	9597	" Screw Stud.....
1656J	9597	" Thumb Nut.....
136558	-----	Clamp complete, Nos. 1656J, 62259 and 136557.....
*62101	-----	Cloth Plate.....
62102	9599	" " Guide Block (left).....
742F	9599	" " " " " Screw....
1547D	9599	" " " " " Nut
62103	9599	" " " " (right).....
3021	9599	" " " " Rivet...
190J	9599	" " Screw.....
62104	9599	" " Stop.....
26770	9599	" " Rivet.....
62105	9599	Cloth Plate complete, Nos. 742F, 1547D, 26770, 62101 to 62104 and two 3021..
*124800	-----	Cylinder.....
62189	9599	" Bottom Cover.....

No.	Plate	Name
124742	9599	Cylinder End Cover.....
124743	9599	" " " 124742 with 1034D, 62111,62113,62185,62189,124744 and four 1477D.....
62185	9599	Cylinder End Cover Bracket.....
62111	9599	" " " " Hinge Pin...
1477D	9599	" " " " Screw.....
124744	9599	" " " Hinge.....
1477D	9599	" " " " Screw.....
62113	9599	" " " Spring.....
1034D	9599	" " " " Screw.....
124745	9594	" 011 Well Cover.....
236J	9594	" " " " Screw.....
59711	23151	Face Plate.....
59712	23151	Face Plate complete, Nos.208J,9544,9545, 59711 and two each 229J, 2107 and 9543.....
164J	23151	Face Plate Screw.....
2107	23151	" " Thread Guard.....
229J	23151	" " " " Screw.....
9543	23151	" " " Nipper Disc.....
9544	23151	" " " " Cover....
208J	23151	" " " " " Screw
9545	23151	" " " " " Spring....
63940	23152	Feed Across Connection (lever end) with two 896E.....
63941	-----	Feed Across Connection (lever end) 63940 with 55381.....
55381	23152	Feed Across Connection (lever end) Ball Stud.....
641C	23152	Feed Across Connection (lever end) Ball Stud Set Screw.....
63942	23152	Feed Across Connection (regulator end) with two 896E.....
63943	-----	Feed Across Connection (regulator end) 63942 with 63944.....
63944	23152	Feed Across Connection (regulator end) Ball Stud.....
62115	23152	Feed Across Connection Adjusting Stud...
1649C	23152	" " " " " Nut (left).....
1650C	23152	Feed Across Connection Adjusting Stud Nut (right).....
896E	23152	Feed Across Connection Cap Screw.....
62147	23152	" " Lever with 641C and 1952....
124676	-----	" " " 62147 with 17737.....
17737	23152	" " " Hinge Stud.....
160D	23152	" " " " Clamping Screw.....
62149	9597	Feed Across Lever Plate with 62153.....

No.	Plate	Name
124660	9597	Feed Across Lever Plate Cover.....
1094F	9597	" " " " Screw.....
55300	9597	" " " " Steady Pin.....
1952	23152	" " " Roller and Stud.....
124847	23152	" " Regulator.....
124848	-----	" " " 124847 with 1188D, 1655E, 14017 and 50324E.....
50599D	23152	Feed Across Regulator Adjusting Screw Stud.....
1676C	23152	Feed Across Regulator Adjusting Screw Stud Nut.....
46244	23152	Feed Across Regulator Adjusting Screw Stud Nut Washer (fibre).....
17738	23152	Feed Across Regulator Adjusting Screw Stud Nut Washer (steel).....
1188D	23152	Feed Across Regulator Hinge Screw.....
62152	23152	" " " Link.....
50324E	23152	" " " " Screw Stud...
1655E	23152	" " " " " " Nut
14017	23152	" " " " " " " "
		Washer.....
62153	9597	Feed Across Regulator Link Stud.....
136559	9599	" Cam with two 1192C, four each 190J, 17874, 136562 and eight 335J.....
39211	9594	Feed Cam Driving Worm with 1441C and 1442C.....
1442C	9594	Feed Cam Driving Worm Position Screw....
1441C	9594	" " " " Set Screw.....
39212	9599	" " " " Wheel with 453C...
18384	9599	" " " " " Pin.....
453C	9599	" " " " " Set Screw...
18384	9599	" " Pin.....
1192C	9599	" " Set Screw.....
62155	9599	" " Shaft.....
55419	-----	" " " 62155 with 1653C and 39212
1653C	9599	" " " Nut.....
136560	9597	" Plate.....
*18445	-----	" " Carrier Bar.....
124662	9597	" " " " 18445 with 934J, 1094F,1195E,8505,17743,18368,62149, 124660, two 55300 and four 17806....
59730	9597	Feed Plate Carrier Bar Pivot Block.....
50306D	9597	" " " " " " Screw
18368	9597	" " " " " Plate.....
934J	9597	" " " " " Screw.....
1654C	9597	" " Nut.....
17806	9597	" " Position Stud.....
1195E	9597	" " Screw Stud.....
8505	9597	" " " Rivet.....
62157	23152	" Regulator with 1953.....

No.	Plate	Name
62148	23152	Feed Regulator Bracket with three 160D..
62191	-----	" " " 62148 with 39313 and 62157.....
160D	23152	Feed Regulator Bracket Cap Screw.....
8589	23152	" " " Dowel Pin.....
1177D	23152	" " " Screw.....
17744	9597	" " Hinge Stud.....
17743	9597	" " Post.....
1953	23152	" " Roller and Screw Stud with 1655C and 14017.....
1655C	23152	Feed Regulator Roller and Screw Stud Nut.....
14017	23152	Feed Regulator Roller and Screw Stud Nut Washer.....
1190C	9597	Feed Regulator Stop Screw.....
39313	9597	" " Swivel.....
1191D	9597	" " Thumb Screw.....
124684	23156	Knife.....
208D	23156	" Screw.....
17718	23156	" Washer.....
124749	23156	Loop Finger.....
124750	9594	" " Cam with 50274C.....
124824	23156	" " Carrier.....
124797	-----	" " " 124824 with 124753..
124752	23156	" " " Crank with 208D and 124755.....
208D	23156	Loop Finger Carrier Crank Clamping Screw
124753	23156	" " " Holder.....
208J	23156	" " " Screw.....
124754	23156	" " " Pitman with four 218D
124791	-----	" " " " 124754 with 124752 and 124757.....
124755	23156	Loop Finger Carrier Pitman Ball Stud....
218D	23156	" " " Cap Screw....
124757	23156	" " Driver with 51868 and 124755
124758	9594	" " " Cam with two 50150C..
50150C	9594	" " " Set Screw.....
50183D	23156	" " " Hinge Screw.....
51868	23156	" " " Roller and Stud.....
124759	9594	" " Rocking Frame.....
229J	23156	" " Screw.....
124760	9594	Looper with 34418.....
124761	9594	" Driving Shaft.....
124762	9594	" " " Bushing.....
52045	9594	" " " " Packing (cotton).....
1143C	9594	Looper Driving Shaft Bushing Set Screw..
59707	9594	" " " Gear with two 1253C
59747	9594	" " " Cover.....
190J	9594	" " " " Screw...

No.	Plate	Name
1253C	9594	Looper Driving Shaft Gear Set Screw.....
50274C	9594	" Set Screw.....
124763	9594	" Shaft.....
124764	9594	" " Bushing.....
50189C	9594	" " " Set Screw.....
124765	9594	" " Coupling with four 50150C..
50150C	9594	" " " Set Screw.....
34418	9594	" Washer.....
62299	23151	Needle Bar with 1072F.....
*39203	-----	" " Connecting Link.....
136588	23151	" " " 39203 with 377C, 1518J and 65135.....
377C	23151	Needle Bar Connecting Link Hinge Screw..
1518J	23151	" " " " " Nut
65135	23151	" " " Stud with 391E....
391E	23151	" " " Set Screw....
59757	9594	" " Crank Wheel with 448C and 1293C.....
1293C	9594	Needle Bar Crank Wheel Position Screw...
448C	9594	" " " Set Screw.....
124794	23151	" " Thread Retainer.....
124796	23151	" " " Bracket with 853C and two 42639.....
853C	23151	Needle Bar Thread Retainer Bracket Set Screw.....
1449H	23151	Needle Bar Thread Retainer Screw.....
124821	23151	" " " Spring.....
42639	23151	" " " Steady Pin...
124795	-----	Needle Bar Thread Retainer complete,Nos. 1449H, 124794, 124796 and 124821....
124766	9594	Needle Guard.....
124601	9594	" " Cam with two 465C.....
465C	9594	" " " Set Screw.....
2273	9594	" " Pin.....
124767	9594	" " Shaft.....
124792	-----	" " " 124767 with 2273 and 124766.....
59761	9594	Needle Guard Shaft Collar with two 465C.
465C	9594	" " " Set Screw.....
124602	9594	" " " Crank with 124974 and two 1253C.....
51857	9594	Needle Guard Shaft Crank Roller.....
124698	9594	" " " Bushing.
124699	9594	" " " " "
124974	-----	Stud.....
1253C	9594	Needle Guard Shaft Crank Roller complete, Nos. 51857, 124698 and 124699.....
59765	9594	Needle Guard Shaft Crank Set Screw.....
59766	9594	" " " Spring.....
59766	9594	" " " Collar with 624C

No.	Plate	Name
624C	9594	Needle Guard Shaft Spring Collar Set Screw.....
233J	9594	Needle Guard Shaft Spring Screw.....
124768	9594	" " Spreader.....
233J	9594	" " " Screw.....
1072F	23151	" Set Screw.....
2058	23151	Presser Bar.....
124769	23154	" " Collar and Thread Pull-off Bracket with two 196C.....
196C	23154	Presser Bar Collar Set Screw.....
17842	23151	" " Guide Bracket with 453C.....
453C	23151	" " " " Set Screw.....
124790	23154	" " Lifting Lever.....
124793	23154	" " " " Bracket.....
164E	23154	" " " " " Screw.....
1201D	23154	" " " " Hinge Screw....
17845	23154	" " " " Rod.....
39408	-----	" " " " " 17845 with 17846.....
17846	23154	Presser Bar Lifting Lever Rod Chain....
32675	23151	" " Spring.....
68712	9594	Pulley (loose) 2 3/4 in. diam. with 200584D.....
68713	-----	Pulley (loose) 68712 with 68714.....
68714	9594	" " Ball Bearing.....
68715	9594	" " Bushing.....
51387R	9594	" " Cap Screw.....
200584D	9594	" " Oil Plug Screw.....
68716	9594	" (tight) 2 7/8 in. diam.....
68720	-----	" " 68716 with 1206C and 17854
2022	9594	" " Pin.....
68717	-----	Pulley (ball bearing) complete, Nos. 51387R, 68713, 68715 and 68720.....
17853	23153	Starting Lever.....
1262C	23153	" " Hinge Screw.....
1662C	23153	" " " " Nut.....
17854	9594	Stop Cam.....
17855	23153	" " Interlocking Rod.....
124784	23153	" " " " Case.....
124770	-----	" " " " " 124784 with 124774, 124901 and two 176D....
124904	-----	Stop Cam Interlocking Rod Case 124770 with 63976 and two 1255D.....
124771	-----	Stop Cam Interlocking Rod Case 124904 with 1318D, 17855, 17863, 17864, 39222 and 68739.....
124772	23153	Stop Cam Interlocking Rod Case Bracket..
124773	-----	Stop Cam Interlocking Rod Case Bracket complete, Nos. 1182E, 1196C, 1204E, 1254C, 1262C, 1508J, 1662C, 17853, 17859, 17861, 17862, 17872, 17873, 124771, 124772 and two 898D.....

No.	Plate	Name
21828	23153	Stop Cam Interlocking Rod Case Bracket Dowel Pin.....
50372D	23153	Stop Cam Interlocking Rod Case Bracket Screw.....
1204E	23153	Stop Cam Interlocking Rod Case Hinge Screw.....
17859	23153	Stop Cam Interlocking Rod Case Socket Joint.....
898D	23153	Stop Cam Interlocking Rod Case Socket Joint Cap Screw.....
11622	9596	Stop Cam Interlocking Rod Case Spring...
19694	9596	" " " " " " Hook
1695C	9596	" " " " " " "
		Lock Nut.....
17861	23153	Stop Cam Interlocking Rod Case Stop Stud
1254C	23153	" " " " " " "
		Bushing.....
1508J	23153	Stop Cam Interlocking Rod Case Stop Stud Bushing Lock Nut.....
17862	23153	Stop Cam Interlocking Rod Case Stop Stud Spring.....
124774	23153	Stop Cam Interlocking Rod Case Wearing Block.....
176J	23153	Stop Cam Interlocking Rod Case Wearing Block Screw.....
17863	23153	Stop Cam Interlocking Rod Spring.....
17864	23153	" " " " Stop.....
1318D	23153	" " " " Screw....
68739	23153	" " " " " " Wash- er.....
3012	9594	Stop Cam Pin.....
1206C	9594	" " Screw.....
2102	23154	Tension Disc.....
1560C	23154	" Regulating Thumb Nut.....
50148C	23154	" Screw Stud.....
124687	-----	" " " 50148C with 1560C....
42336	23154	" Spring.....
13915	23154	" " Bushing.....
124805	23154	" Thread Guide.....
50370D	23154	" " " Screw.....
124609	23151	Thread Controller Sleeve.....
124607	23151	" " Spring.....
124608	23151	" " " Collar with 1477F.....
1477F	23151	Thread Controller Spring Collar Set Screw.....
124610	23151	Thread Controller Stud with 56549 and 124631.....
*124631	-----	Thread Controller Stud Collar.....
56549	-----	" " " " Pin.....

No.	Plate	Name
457C	23151	Thread Controller Stud Set Screw.....
124611	-----	Thread Controller complete, Nos. 124607 to 124610.....
*124612	-----	Thread Nipper (lower) Blade.....
124613	-----	" " " " Carrier with 124619.....
124614	23154	Thread Nipper (lower) Blade Carrier 124613 with 124612 and two 6037.....
665J	23154	Thread Nipper (lower) Blade Carrier Cap Screw.....
124615	23156	Thread Nipper (lower) Blade Carrier Hinge Stud.....
6037	23154	Thread Nipper (lower) Blade Rivet.....
136562	9599	" " " " Cam.....
335J	9599	" " " " Screw.....
124653	23154	" " " " Connection.....
124618	23154	" " " " Extension
99K	23154	" " " " " " Hinge Screw.....
206J	23154	Thread Nipper (lower) Connection Extension Screw.....
124619	23154	Thread Nipper (lower) Connection Hinge Stud.....
124620	23154	Thread Nipper (lower) Driving Arm.....
8554	23154	" " " " " " Pin..
136563	23154	" " " " Lever with 237K...
8554	23154	" " " " " " Pin.....
237K	23154	" " " " " " Set Screw...
124623	23154	" " " " " " Shaft.....
124957	23154	" " " " " " Bracket
136578	-----	Thread Nipper (lower) Lever Shaft Bracket complete, Nos. 8554, 124620, 124623, 124957 and 136563.....
51188J	23154	Thread Nipper (lower) Lever Shaft Bracket Screw.....
17738	23154	Thread Nipper (lower) Lever Shaft Bracket Screw Washer.....
1743D	23154	Thread Nipper (upper) Adjusting Thumb Nut.....
59773	23154	Thread Nipper (upper) Body.....
447C	23154	" " " " " " Set Screw....
59774	9594	" " " " " " Cam with two 50150C
50150C	9594	" " " " " " Set Screw.....
2921	23154	" " " " " " Disc.....
12162	23154	" " " " " " Guide Pin....
62169	23154	" " " " " " Spring.....
59775	23154	" " " " " " Eyelet.....
1527D	23154	" " " " " " Lock Nut.....
59776	23154	" " " " " " Stud with 13538....
13538	23154	" " " " " " Position Pin..

No.	Plate	Name
13539	23154	Thread Nipper (upper) Stud Roller.....
13540	23154	" " " " " " Pin...
2026	23154	" " " " " " Spring.....
59777	-----	Thread Nipper (upper) Stud complete, Nos. 13539, 13540 and 59776.....
59778	23154	Thread Nipper (upper) complete, Nos. 1527D, 1743D, 2026, 59773, 59775, 59777, 62169 and two 2921.....
124804	23156	Thread (lower) Pull-off.....
62124	9594	" " " " " " Bar with 62130 and two 3021.....
124933	9596	Thread (lower) Pull-off Bar Check.....
124934	9596	" " " " " " Plunger
124935	9596	" " " " " " " " Case.....
1186D	9596	Thread (lower) Pull-off Bar Check Plunger Case Screw.....
1722D	9596	Thread (lower) Pull-off Bar Check Plunger Lock Nut.....
1722D	9596	Thread (lower) Pull-off Bar Check Plunger Nut.....
124938	9596	Thread (lower) Pull-off Bar Check Plunger Spring.....
51120J	9596	Thread (lower) Pull-off Bar Check Regulating Screw.....
51591J	9596	Thread (lower) Pull-off Bar Check Regulating Screw Lock Nut.....
50152D	9596	Thread (lower) Pull-off Bar Check Screw.
124936	-----	Thread (lower) Pull-off Bar Check complete, Nos. 51120J, 51591J, 124933 to 124935, 124938 and two 1722D.....
62126	9596	Thread (lower) Pull-off Bar Connection with 17917.....
17915	9596	Thread (lower) Pull-off Bar Connection Slide Block.....
17917	-----	Thread (lower) Pull-off Bar Connection Slide Block 17915 with 17916.....
17916	9596	Thread (lower) Pull-off Bar Connection Slide Block Stud.....
59734	9596	Thread (lower) Pull-off Bar Driving Lever with 223F and 59735.....
59805	-----	Thread (lower) Pull-off Bar Driving Lever 59734 with 1382F.....
1382F	9596	Thread (lower) Pull-off Bar Driving Lever Hinge Screw.....
1681C	9596	Thread (lower) Pull-off Bar Driving Lever Hinge Screw Nut.....
59735	9596	Thread (lower) Pull-off Bar Driving Lever Lock Stud.....
223F	9596	Thread (lower) Pull-off Bar Driving Lever Lock Stud Screw.....

No.	Plate	Name
124788	23156	Thread (lower) Pull-off Bar Guide and Knife Holder.....
1235F	23156	Thread (lower) Pull-off Bar Guide Screw.
62128	23156	" " " Holder with 59739
62129	23156	" " " Cap with 59739.....
50018F	23156	Thread (lower) Pull-off Holder Cap Screw
1547J	23156	" " " " " "
		Nut.....
59739	23156	Thread (lower) Pull-off Holder Cap Stud.
62130	9594	" " " " Connection
3021	9594	" " " " "
		Rivet.....
59739	23156	Thread (lower) Pull-off Holder Stud.....
236F	23156	" " " Screw.....
124803	23154	" (upper) Pull-off (double).....
202J	23154	" " " Screw.....
7071	23154	" " " Washer....
124625	23151	" Take-up Body with 62172.....
42808	23151	" " Roller.....
62171	23151	" " " Cap.....
337J	23151	" " " Screw.....
62172	23151	" " " Pin.....
124626	-----	Thread Take-up complete, Nos.337J,42808, 62171 and 124625.....
691F	23151	Thread Take-up Screw.....
39452	23151	" Wiper Body.....
124806	23151	" " " Finger.....
330J	23151	" " " Screw.....
1207D	23151	" " " Hinge Screw.....
124777	23151	" " " Support.....
136556	-----	Thread Wiper Body Support 124777 with 1207D,1302D,39452,39455 and 39456...
641C	23151	Thread Wiper Body Support Set Screw.....
39455	23151	" " " Wire.....
39456	23151	" " " Clamp.....
1302D	23151	" " " Screw.....
124789	23156	Throat Plate with 124615.....
124955	23156	Throat Plate complete, Nos. 208D, 1547J, 1771B, 50018F, 62128, 62129, 124684, 124778,124788,124789,124804 and two each 206D, 236F and 1235F.....
124778	23156	Throat Plate Needle Guard.....
206D	23156	" " " Screw.....
691F	23156	" " " Screw.....
17872	23153	Trip Lever.....
1196C	23153	" " Hinge Screw.....
17873	23153	" " Spring.....
1182E	23153	" " " Screw.....
17874	9599	Tripping Point.....
190J	9599	" " " Screw.....
*15404	-----	Trade Mark.....
15405	-----	" " Rivet.....

MACHINE No. 114-41

For Tacking Paper Tickets on Clothing to Distinguish Lot, Color, Size, etc., while in process of Manufacture. Triangular tack, 14 stitches, base toward operator. Thread cutter, leaves long end to unravel projecting on top of the material. Speed 1500 R. P. M.

NOTE: THIS MACHINE IS THE SAME AS THE NO. 114-39 MACHINE, WITH THE FOLLOWING EXCEPTIONS:

No.	Plate	Name
136564	9598	Clamp with 1220E, 17928 and 136565, in place of 136557.....
*136565	-----	Clamp Loop Finger.....
136580	-----	Clamp complete, Nos. 1656J, 62259 and 136564, in place of 136558.....
124801	9600	Feed Cam with two 1192C, three each 190J, 17874,124616,124622 and twelve 335J, in place of 136559.....
18415	9595	Feed Cam Driving Worm with 1441C and 1442C, in place of 3921L.....
17797	9600	Feed Cam Driving Worm Wheel with 453C, for 62264.....
*62264	-----	Feed Cam Shaft 62155 with 1653C and 17797, in place of 55419.....
124802	9598	Feed Plate, in place of 136560.....
124616	9600	Thread Nipper (lower) Cam, in place of 136562.....
124621	23155	Thread Nipper (lower) Lever with 237K, in place of 136563.....
124622	9600	Thread Nipper (lower) Lever Guide.....
335J	9600	" " " " " Screw.

ATTACHMENTS AND ACCESSORIES

No.	Plate	Name
124958	23157	Cylinder Base Plate with two 453C.....
18420	23157	" " " Hinge Connection....
18423	23157	" " " " " Hinge Pin.....
453C	23157	Cylinder Base Plate Hinge Connection Hinge Pin Set Screw.....
134E	23157	Cylinder Base Plate Screw.....
124959	23157	Cylinder Base Plate (hinged) complete, Nos. 124958, two each 18420, 18423, three wood screws 1 1/4 in. No. 12 and four 134E.....
124975	-----	Cylinder Base Plate 124959 with 124966..
124960	23157	Machine Supporting Bracket (lower).....
178J	23157	" " " " " Screw
124961	23157	" " " (upper).....
1396J	23157	" " " " " Screw
124962	23157	" " Link (lower).....
124963	23157	" " " (upper).....
124964	23157	" " " Hinge Rivet....
124965	23157	" " " Lock Plate.....
190333	23157	" " " " " Lock Stud.....
124964	23157	Machine Supporting Link Lock Plate Rivet
124966	23157	Machine Support complete, Nos. 178J, 1396J, 124960 to 124963, 124965, 190333 and four 124964.....
120346	23157	Oiler (copper plated) with 120347.....
120347	23157	" Spout, 8 1/2 in. long.....
11831	23157	Screw Driver (machine).....
26026	23157	" " (shuttle tension).....
4822	23157	Wrench for 1547.....
10875	23157	" " 1518, 1520, 1649, 1650 and 1662.
17905	23157	" " 1176, 1178, 1654, 1655 and 1676.
25200	23157	" " 1527.....
27662	23157	" " 1254 and 1508.....

EYE AND FINGER GUARD

No.	Plate	Name
121603	23158	Eye and Finger Guard (glass).....
121604	23158	Carrying Arm.....
1004K	23158	" " Hinge Screw (back).....
1698J	23158	" " " " " Nut.....
50222K	23158	" " " " (front).....
1735J	23158	" " " " " Nut....
121605	23158	" " Spring.....
50435K	23158	Depressing Screw.....
121606	23158	" " Holder.....
140061J	23158	" " " Screw.....
121607	23158	Frame.....
121608	-----	" 121607 with 121603.....
50165J	23158	" Screw.....
121609	23158	Guiding Rod.....
50435K	23158	" " Hinge Screw.....
121611	23158	Holder.....
121612	23158	Supporting Bracket.....
191J	23158	" " " Screw.....
*121613	-----	Eye and Finger Guard complete, Nos. 1004K, 1698J, 1735J, 50222K, 50435K, 121604, 121605, 121608, 121609, 121611, 121612 and two 50165J.....
136586	23158	Face Plate.....
2107	23158	" " Thread Guard.....
229J	23158	" " " " " Screw.....
9543	23158	" " " " " Nipper Disc.....
9544	23158	" " " " " Cover.....
208J	23158	" " " " " " Screw
9545	23158	" " " " " Spring....
136587	-----	Face Plate complete, Nos. 208J, 9544, 9545, 136586 and two each 229J, 2107 and 9543.....
121627	23158	Eye and Finger Guard with Face Plate complete, Nos. 50435K, 121606, 121613, 136587, 140061J and two 191J.....

FOOT LIFTER PARTS

No.	Plate	Name
17876	23159	Treadle with 443C.....
17877	23159	" Pitman Rod (lower).....
17878	23159	" " " (upper).....
17879	23159	" " " Clamp with two 161E..
161E	23159	" " " " Screw.....
17880	-----	Treadle Pitman complete, Nos. 17877 to 17879.....
17881	23159	Treadle Shaft.....
443C	23159	" " Set Screw.....
17882	23159	" Spring.....
17883	23159	" Stand.....
17884	23159	Treadle complete, Nos. 17876, 17881 to 17883 and two wood screws 1 in. No. 10.....
17885	-----	Treadle and Pitman complete, Nos. 17880 and 17884.....

STARTING LEVER

No.	Plate	Name
13351	23159	Chain, 46 in. to 55 in. long, with 56864 and 56865.....
Note: When ordering No. 13351, give length required.		
56864	23159	Chain Hook (large).....
56865	23159	" " (small).....
17876	23159	Treadle with 443C.....
17881	23159	" Shaft.....
443C	23159	" " Set Screw.....
17882	23159	" Spring.....
17883	23159	" Stand.....
17884	23159	Treadle complete, Nos. 17876, 17881 to 17883 and two wood screws 1 in. No. 10.....

TABLE BELT GUIDE

No.	Plate	Name
39218	23159	Belt Guide with two 168E.....
168E	23159	" " Set Screw.....
17892	23159	Bracket with two 153E.....
17893	23159	Pulley.....
39219	23159	" Shaft (long) with 17896 and 63973
63973	23159	" " " Wick (braided cotton)
39220	23159	" " (short) with 17896 and 63974
63974	23159	" " " Wick (braided cotton)
17896	23159	" " Plug.....
153E	23159	" " Set Screw.....
39221	23159	Table Belt Guide complete, Nos. 17892, 39219, 39220, two each 17893, 39218 and three wood screws 1 1/4 in. No. 12.....

THREAD UNWINDER

FOR ONE LARGE POOL OR ONE LARGE CONE OF THREAD

No.	Plate	Name
225259	23160	Spool Rest with 201018C.....
150203	23160	" " Cushion (felt).....
225388	23160	" " Rod.....
200383C	23160	" " " Set Screw.....
201018C	23160	" " Set Screw.....
202490	23160	" Stand with 200383C.....
225391	23160	Thread Guide.....
60771	23160	" Guide.....
60772	-----	" " 60771 with 41635.....
41635	23160	" " Bracket with 175E.....
175E	23160	" " " Set Screw.....
201696J	23160	" " Lock Nut.....
225326	23160	" " Position Cup.....
225324	23160	" " Rod with 208E and 225322...
208E	23160	" " " Screw.....
225322	23160	" " " Washer.....
225260	-----	Thread Unwinder complete, Nos. 150203, 201696J, 202490, 225259, 225324, 225326, 225388, 225391 and three wood screws 7/8 in. No. 12.....
27739	23160	Thread Cone (wood) for large cones.....
225390	23160	" " Holder, for inverted cones..
Note: Nos. 27739 and 225390 are used with, but not included in 225260.		
60773	23160	Thread Unwinder with Thread Guide complete, Nos. 60772 and 225260.....

9597 - 1/2

114-39

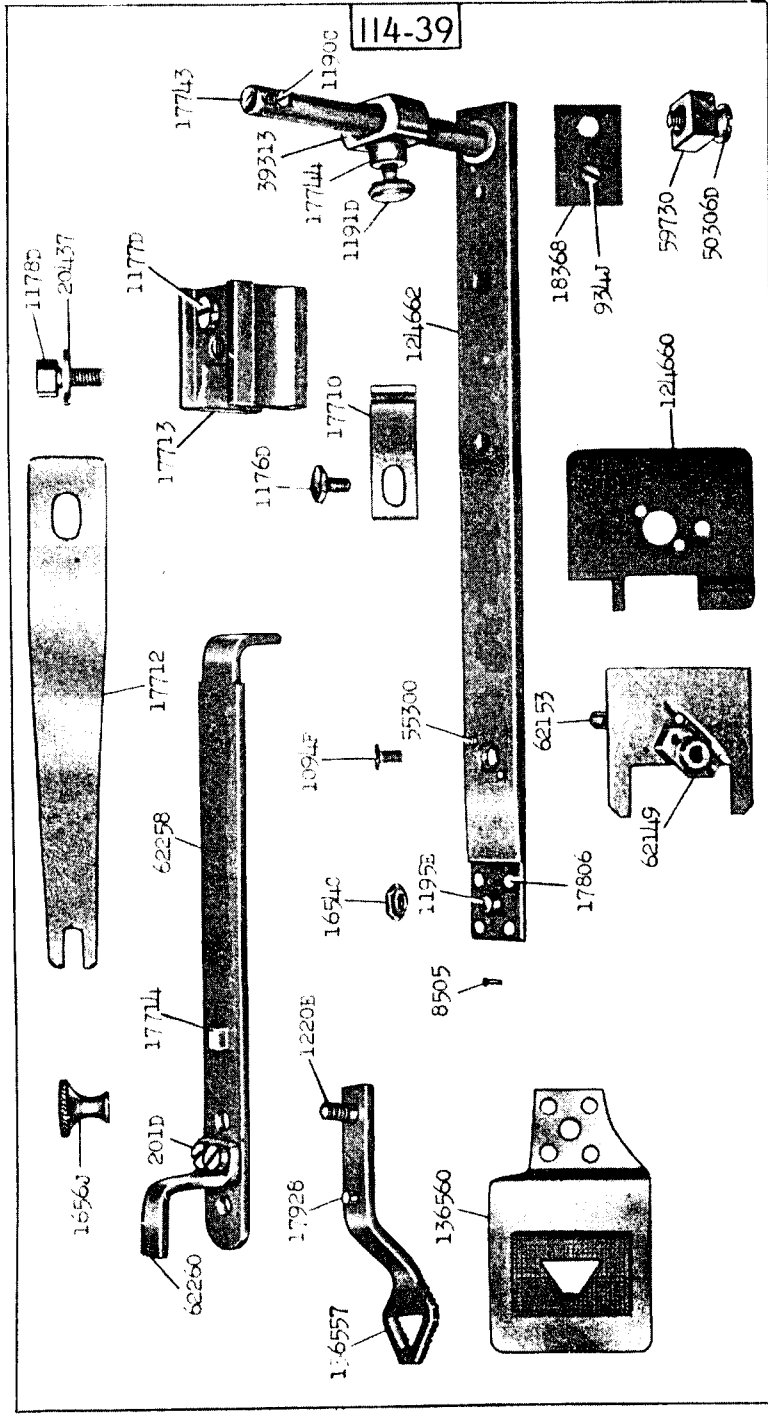

9598 - 1/2

114-41

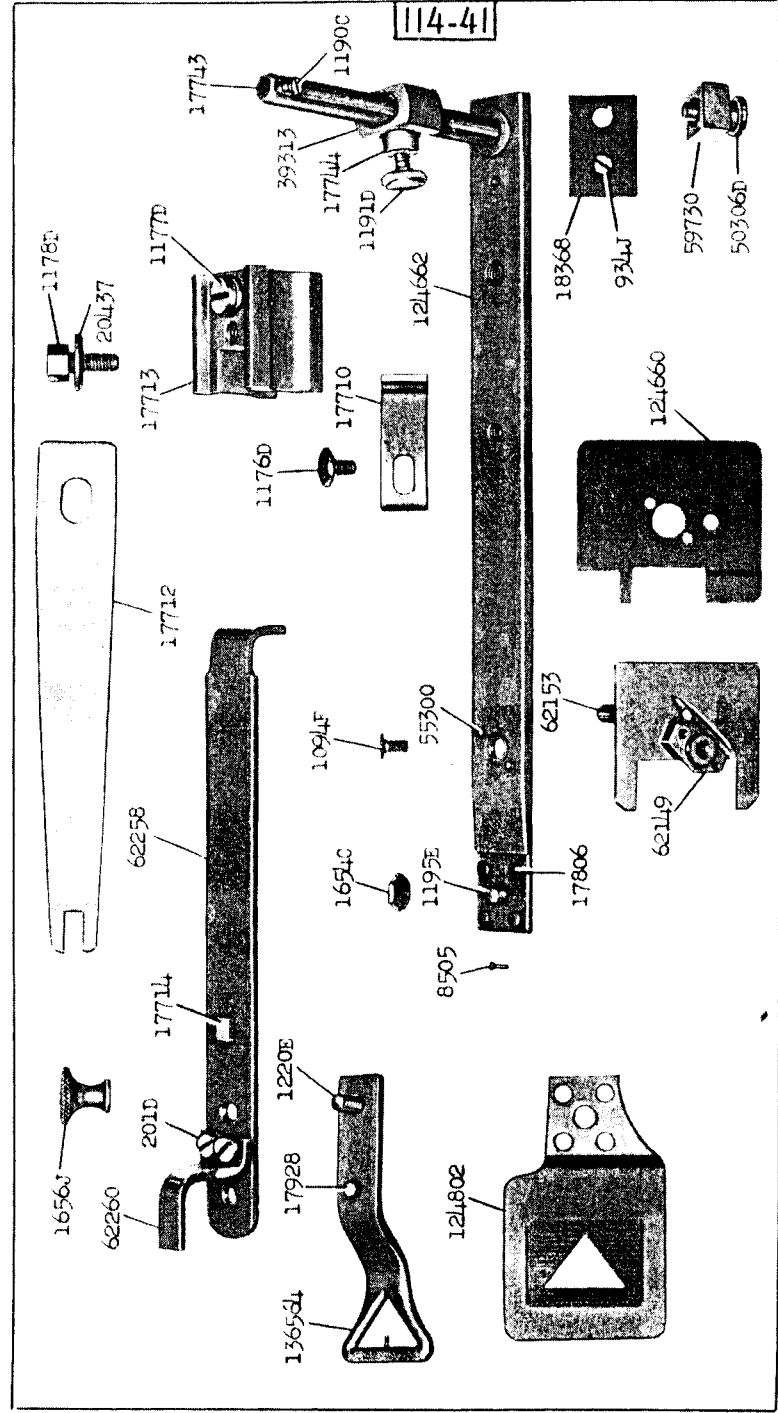

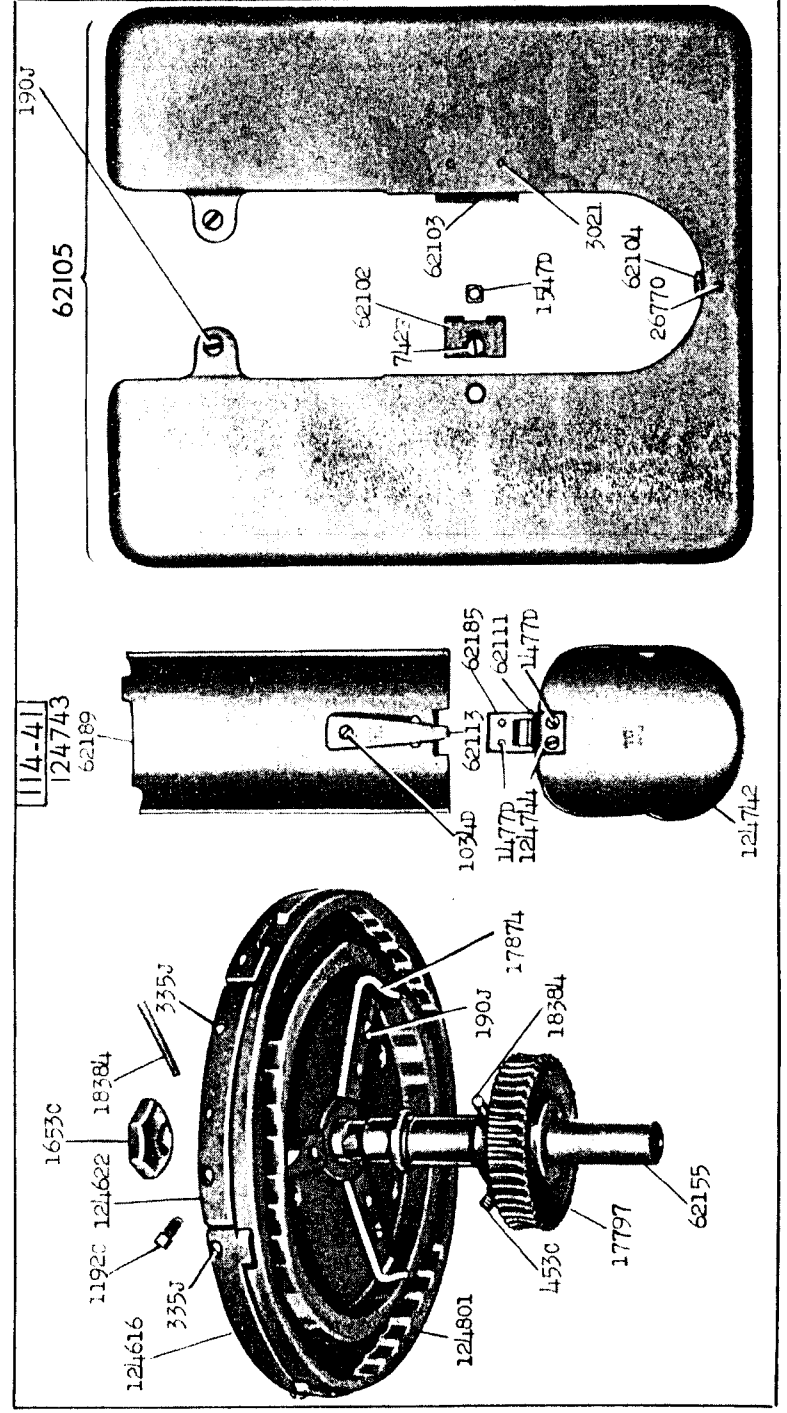
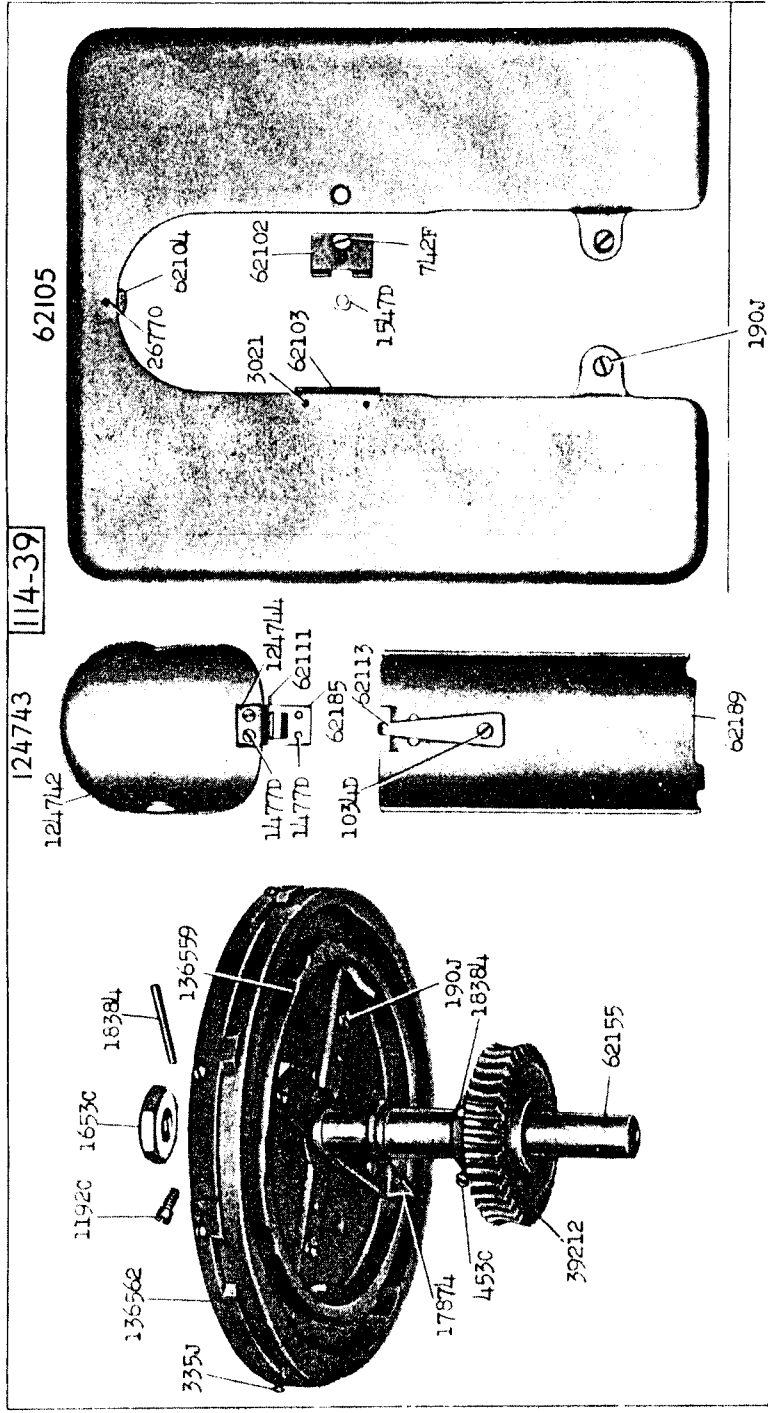

23151 - 1/2

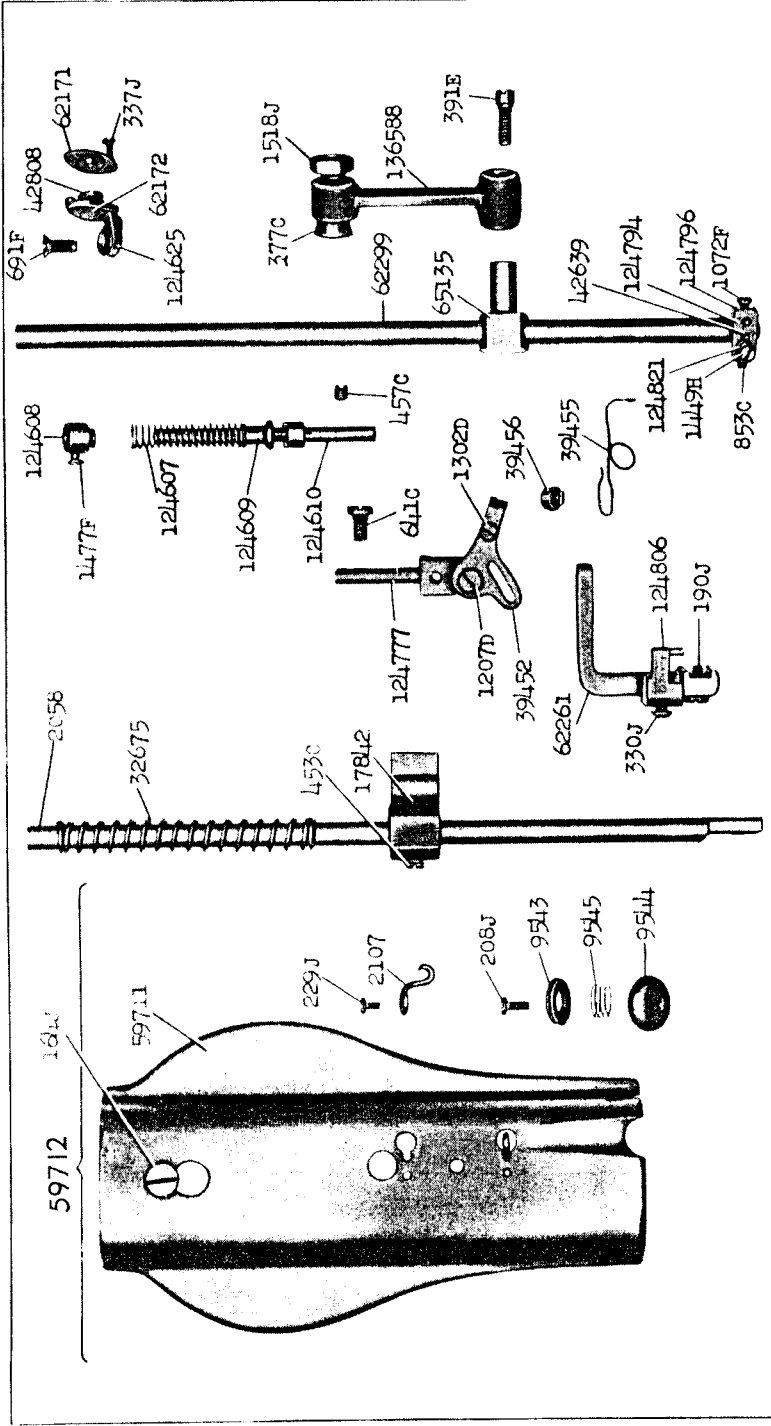

23152 - 1/2

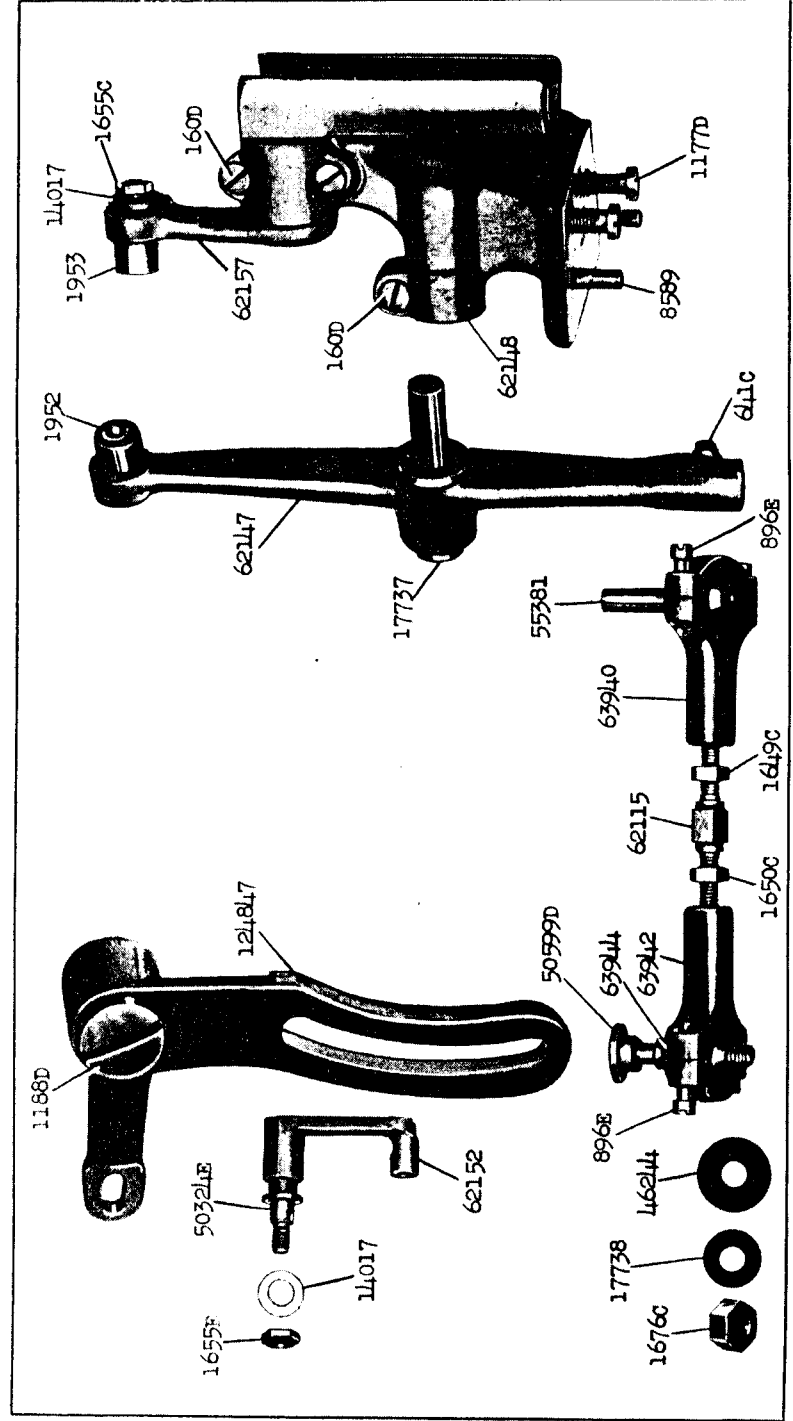

114-41

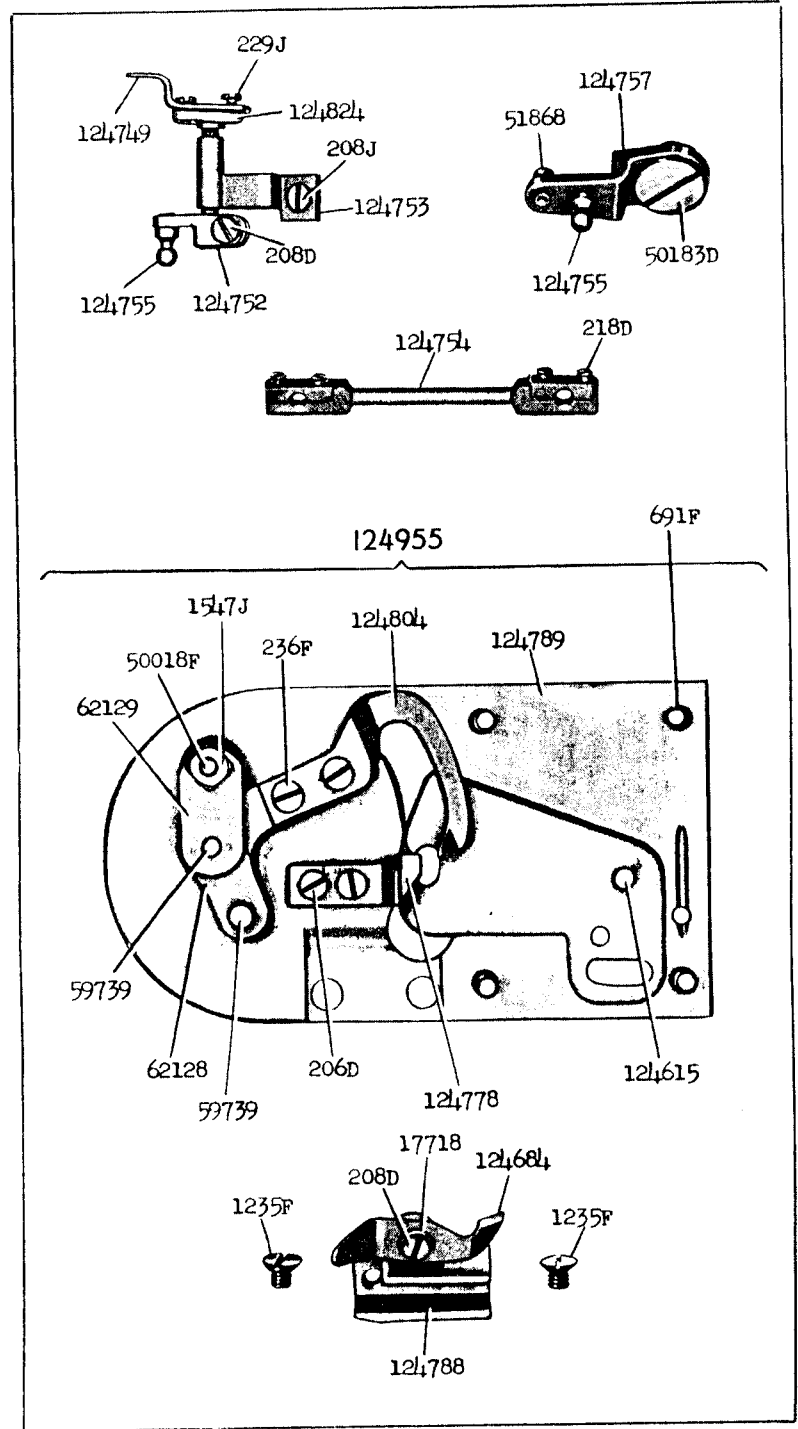
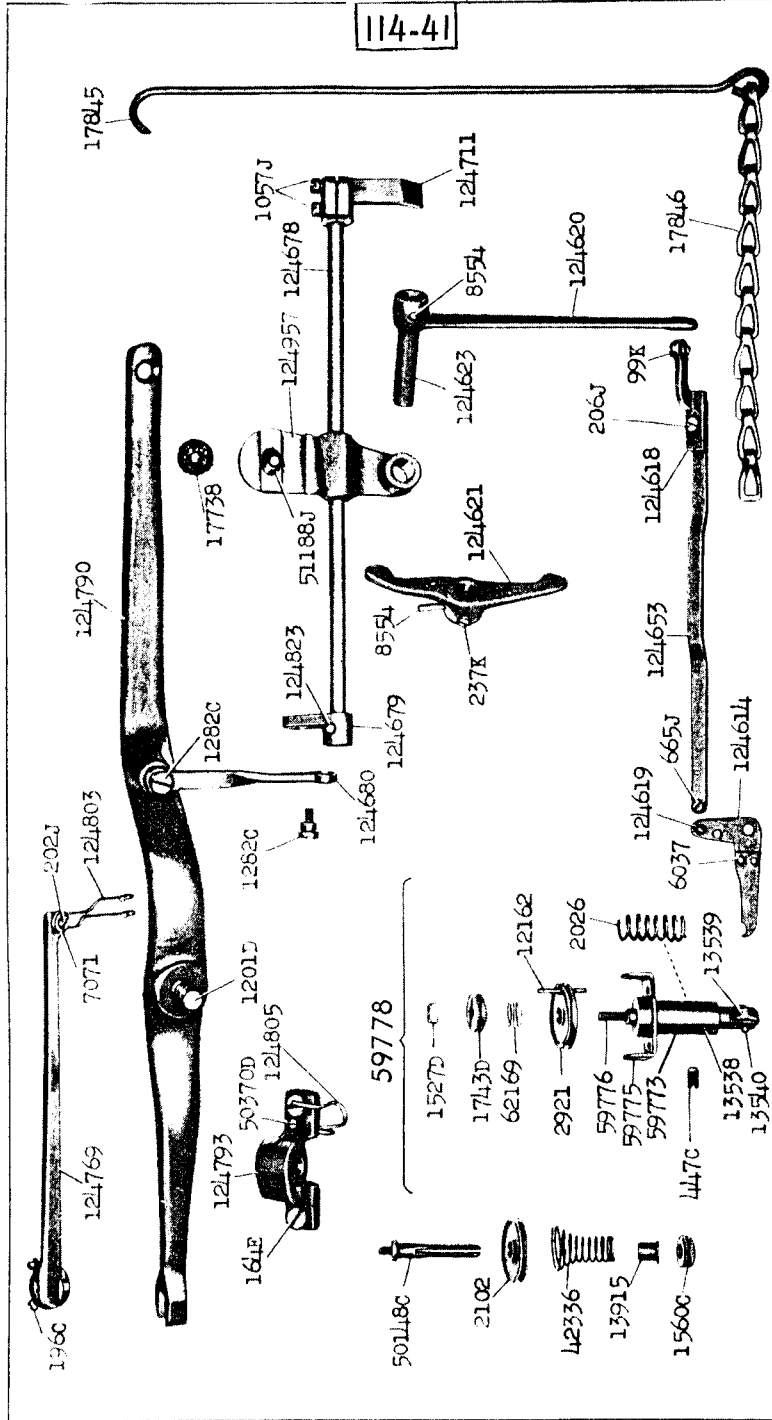

23157 - 1/3

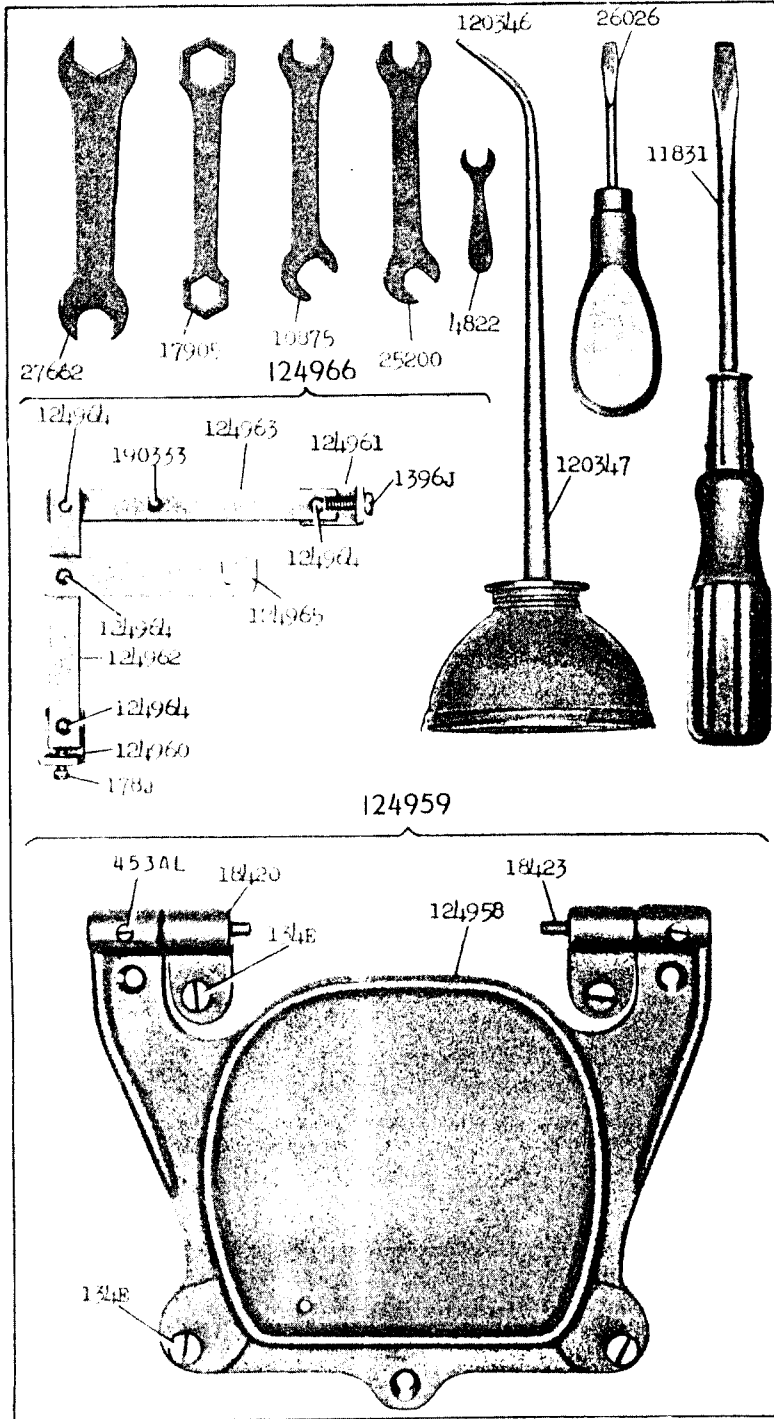

23158 - 2/3

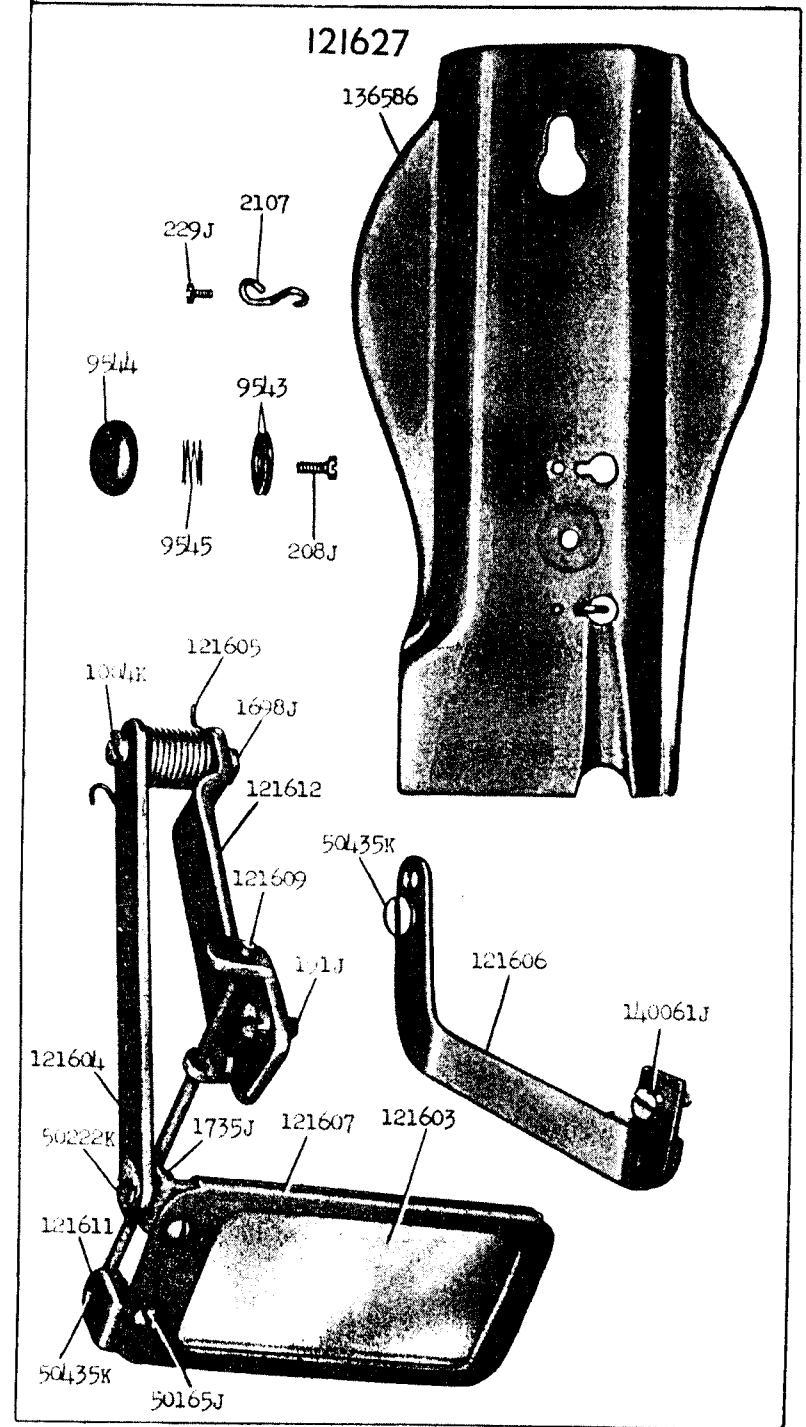

23159 - 1/3

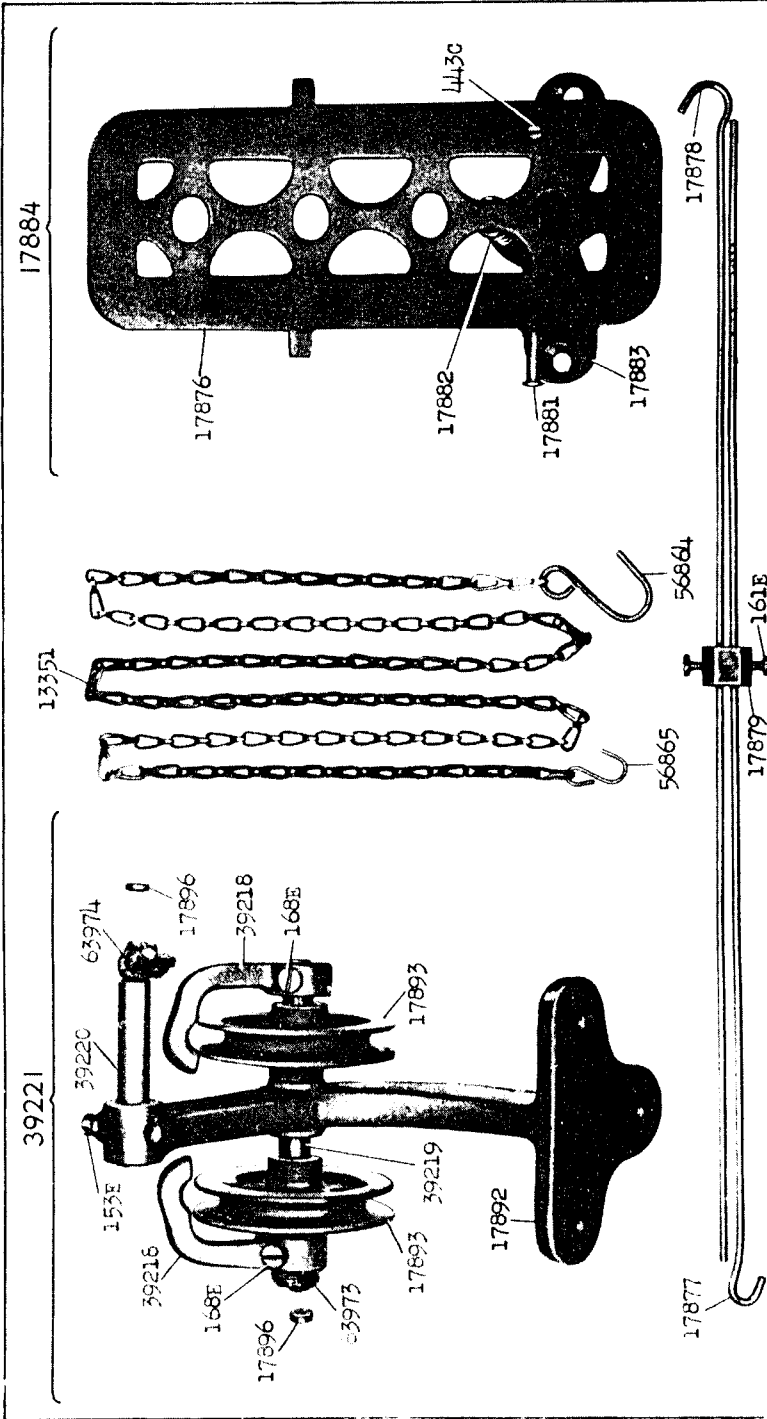

23160 - 1/4

