

**SINGER**  
**110W126,W127**

# LIST OF PARTS



## MACHINES

Nos. 110w126 and 110w127

---

THE SINGER MANUFACTURING COMPANY

# Instructions for Ordering

In ordering from this list, use **ONLY** the **PART** number in the **FIRST** column.

The number stamped on a Sewing Machine Part is the number of the Single Part only, except when the part includes Set Screws, Clamping Screws, Studs and Rollers Spun on, Small Wires riveted, or Parts soldered together, etc., which it is necessary to furnish in combination.

Every combination of parts sent out has its specific number which, although not stamped on Parts (except in above cases) must be used when ordering the combination.

Each number always indicates the **SAME PART** in whatever list it appears, or for whatever Machine.

The letters after some of the numbers indicate the style or finish only, as follows:

- A. Hardened, Polished and Plated.
- B. Polished and Plated.
- C. Hardened only.
- D. Polished only.
- E. Soft, not polished.
- F. Hardened and Polished.
- H. Blued.

These letters **MUST BE USED** when they appear in the list and **AFTER** the number, as in the list.

In this series

200001 to 201500 are Screw Numbers.

201501 to 201800 are Nut Numbers.

201801 to 202000 are Roller Numbers.

202001 and upwards are Numbers of Machine Parts.

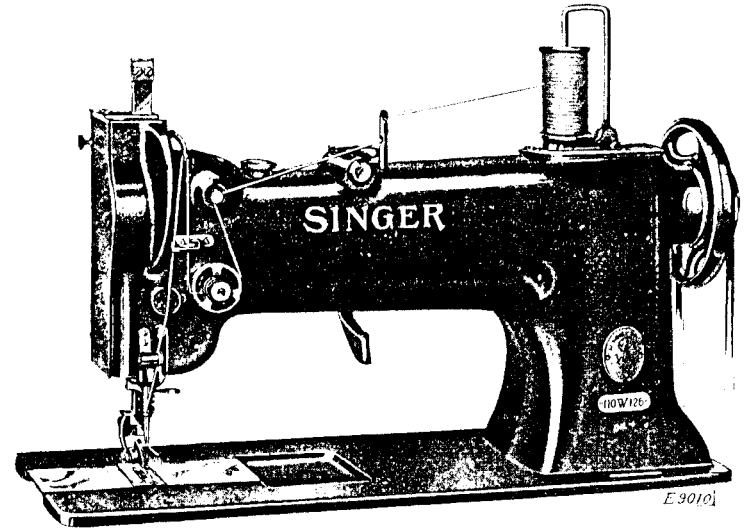
The figures in the second column refer only to the plate in which the illustration of the part is shown and are **NOT TO BE USED** in ordering.

Two or more numbers over a cut indicate that the difference between such parts is not visible in an illustration.

Parts marked with an asterisk (\*) are furnished only when repairs are made at the factory.

## LIST OF PARTS COMPLETE

FOR



## MACHINE No. 110w126

VERTICAL HOOK. ROLLER PRESSER.

CONTINUOUS WHEEL FEED.

VERTICAL TRIMMER

For Leather Work

No.	Plate	Name
*237801	—	Arm .....
203091	14196	" Cap .....
200278n	14176	" " Screw .....
202248	14176	" " " Washer .....
203089	14196	" " Spool Holder Base .....
203090	14196	" " " " " 203089 with 200079n and 204296 .....
200585n	14187	Arm Cap Spool Holder Base Screw
204296	14196	" " " " Wire .....
200079n	14187	" " " " " Hinge Screw .....

No.	Plate	Name
203092	—	Arm Cap and Spool Holder complete, Nos. 203090, 203091 and two 200585H .....
204235	14187	Arm Position Pin (2) .....
200004E	14176	" Screw .....
200010E	14176	" " (2) .....
202005	14176	" " Washer (3) .....
202632	14196	" Side Plate .....
200462B	14176	" " " Thumb Screw .....
237802	14414	" Shaft with 200357E and 203100 .....
237748	14196	" " Bushing (back) with 202299 .....
202299	—	Arm Shaft Bushing (back) Oil Packing (wick) .....
200071E	14176	Arm Shaft Bushing (back) Screw (3) .....
207080	14196	Arm Shaft Bushing (front) with 202244 .....
202244	—	Arm Shaft Bushing (front) Oil Packing (wick) .....
200502B	14176	Arm Shaft Bushing (front) Oil Packing Thumb Screw .....
200338C	14176	Arm Shaft Bushing (front) Set Screw .....
203100	—	Arm Shaft Oil Packing (wick) ....
200357E	14176	" " " " Stop Screw ..
223842	14414	Balance Wheel (belt groove 2 3/4 in. diam.) with 200328c and 200335c .....
200062H	14176	Balance Wheel Adjusting Screw ..
200328c	14176	" " Position Screw ...
200335c	14176	" " Set Screw .....
*237834	—	Bed .....
237901	14196	" Slide (back) .....
237835	14196	" " (front) .....
203470	14176	Bobbin .....
*203520	—	" Case .....
203648	14176	" " Latch .....
*202056	—	" " " Pin .....
203473	14176	" " " Plunger .....
203474	14176	" " " Spring .....
236078	14176	" " Lever .....
*203476	—	" " " Eccentric .....
204243	14176	" " " Position Pin .....
235751	14176	" " " Fulcrum .....
200056D	10884	" " " Screw ....
203478	14176	" " " Slide Stud .....
203214	14176	" " Tension Spring .....
200984c	14176	" " " " Regulat- ing Screw .....

No.	Plate	Name
200594c	14176	Bobbin Case Tension Spring Screw
203216	—	" " Washer (cloth) .....
203521	14176	Bobbin Case complete, Nos. 200594c, 200984c, 202056, 203214, 203216, 203473, 203474, 203520 and 203648 .....
237804	14414	Face Plate .....
202135	14176	" " Position Pin .....
200473B	14176	" " Thumb Screw .....
237707	14190	Feed Wheel .....
350085F	14398	" " Adjusting Screw ....
237708	14398	" " " " Block .....
238603	14410	" " Bracket with 238630 ..
238604	14410	" " " Plate .....
200158H	14398	" " " " Screw (2) .....
237710	14398	" " " Spring .....
238605	—	" " Driving Gear (for 16 stitches) .....
238606	—	Feed Wheel Driving Gear (for 18 stitches) .....
238607	—	Feed Wheel Driving Gear (for 20 stitches) .....
238613	14398	Feed Wheel Driving Gear Key ....
238614	14398	" " " " " Shift- ing Collar with 201464c .....
201464c	14187	Feed Wheel Driving Gear Key Shift- ing Screw Stud .....
238615	14398	Feed Wheel Driving Gear Key Spring .....
201202D	14398	Feed Wheel Driving Gear Key Spring Screw .....
238616	14398	Feed Wheel Driving Gear Key Stop Pin .....
238617	14398	Feed Wheel Driving Gear Separat- ing Washer .....
238618	—	Feed Wheel Driving Pinion (for 16 stitches) .....
238619	—	Feed Wheel Driving Pinion (for 18 stitches) .....
238620	—	Feed Wheel Driving Pinion (for 20 stitches) .....
231433	14398	Feed Wheel Driving Pinion Key .
238632	14403	" " " " Spacing Washer (for use in place of Feed Wheel Driving Pinion when one or two lengths of stitch are re- quired) .....
238627	14414	Feed Wheel Driving Shaft .....
237722	14410	" " " " Bushing (back) .....



No.	Plate	Name
202302	14399	Knee Lifter Connection Lever Lifting Rod Cotter Pin .....
237838	14414	Knee Lifter Lifting Lever .....
200262H	14399	" " " " Hinge Screw .....
207805	14187	Knife .....
200397H	11610	" Adjusting Screw .....
237806	14190	" Bar .....
237807	14187	" " Angle Extension .....
200126E	14187	" " " " Screw (2) .....
221417	14190	" " Driving Eccentric with 200382c and 200437c .....
202890	14190	Knife Bar Driving Eccentric Fork with 200382c and 201464c .....
201464c	14187	Knife Bar Driving Eccentric Fork Position Screw .....
200382c	14198	Knife Bar Driving Eccentric Fork Set Screw .....
200437c	14187	Knife Bar Driving Eccentric Position Screw .....
200382c	14198	Knife Bar Driving Eccentric Set Screw .....
202891	14192	Knife Bar Driving Shaft Crank with 200694F and 201525E .....
203244	14187	Knife Bar Driving Shaft Crank Collar with two 200393c .....
200393c	14187	Knife Bar Driving Shaft Crank Collar Set Screw .....
200694F	14187	Knife Bar Driving Shaft Crank Screw Stud .....
201525E	14187	Knife Bar Driving Shaft Crank Screw Stud Nut .....
237808	14187	Knife Bar Guide Block .....
200011D	14187	" " " " Screw (2) ..
200337c	14187	" " " " Screw .....
201531E	14187	" " " " Nut .....
237829	14187	" " Lifting Spring .....
202346	14187	" " " " Plunger ..
237809	14198	" " Position Bracket .....
201387F	14198	" " " " Screw (2) ..
237810	14198	" Holder with 200397H .....
200898D	14198	" " Screw .....
237811	14198	" " Switch-in Handle .....
200076D	14198	" Screw (2) .....
237812	14192	" Switch-out Handle with two 200403c .....
200403c	14415	Knife Switch-out Handle Set Screw .....
202899	14192	" " " Shaft .....
202900	14198	" " " Spring (spiral) .....

No.	Plate	Name
237822	14192	Needle Bar with 200389c .....
202552	11607	" " Connecting Link .....
236073	14399	" " " " Oil Guard .....
200161D	11607	Needle Bar Connecting Link Oil Guard Screw .....
202333	11607	Needle Bar Connecting Link Stud with 202254 .....
202254	—	Needle Bar Connecting Link Stud Oil Packing (wick) .....
200374c	14181	Needle Bar Connecting Link Stud Set Screw .....
200383c	14399	Needle Bar Connecting Link Stud Set Screw .....
*206891	—	Needle Bar Connecting Stud .....
202329	11607	" " " " 206891 with 200086c and 202330 .....
202330	—	Needle Bar Connecting Stud Oil Packing (wick) .....
200086c	11607	Needle Bar Connecting Stud Pinch Screw .....
202692	14192	Needle Bar Crank with 200335c, 200374c, 200383c, 200428c and 202333 .....
237737	—	Needle Bar Crank 202692 with 202329, 202399, 202400, 202552 and 237762 .....
203172	11607	Needle Bar Crank Friction Washer .....
200428c	11607	" " " Position Screw ..
200335c	14176	" " " Set Screw .....
237813	14192	" " Rock Frame .....
237814	—	" " " " 237813 with 237822 .....
*38127	—	Needle Bar Rock Frame Driving Eccentric .....
*237749	—	Needle Bar Rock Frame Driving Eccentric Body .....
350107c	14399	Needle Bar Rock Frame Driving Eccentric Body Position Screw ..
443c	14399	Needle Bar Rock Frame Driving Eccentric Body Set Screw .....
1103c	14399	Needle Bar Rock Frame Driving Eccentric Regulating Screw .....
217D	14399	Needle Bar Rock Frame Driving Eccentric Set Screw .....
7071	14399	Needle Bar Rock Frame Driving Eccentric Set Screw Washer ...

No.	Plate	Name
237750	—	Needle Bar Rock Frame Driving Eccentric complete. Nos. 217b, 443c, 1103c 7071, 38127, 237749 and 350107c .....
237739	14192	Needle Bar Rock Frame Driving Fork Lever with 200029E .....
200029E	14399	Needle Bar Rock Frame Driving Fork Lever Pinch Screw .....
237740	14403	Needle Bar Rock Frame Driving Fork Lever Slide Block (two pieces) .....
210910	11607	Needle Bar Rock Frame Hinge Stud with 202277 .....
202277	—	Needle Bar Rock Frame Hinge Stud Oil Packing (wick) .....
200347c	14181	Needle Bar Rock Frame Hinge Stud Set Screw .....
202667	14192	Needle Bar Rock Frame Rock Shaft
210978	—	“ “ “ “ “ “ 202667 with 200386c and 210920..
237815	14198	Needle Bar Rock Frame Position Bracket with 200337c and 201531E
350129E	14198	Needle Bar Rock Frame Position Bracket Screw (2) .....
202668	11607	Needle Bar Rock Frame Slide Block
210920	—	“ “ “ “ “ “ 202668 with 201141c .....
201141c	14399	Needle Bar Rock Frame Slide Block Screw Stud .....
200386c	14415	Needle Bar Rock Frame Slide Block Screw Stud Set Screw .....
200389c	11610	Needle Set Screw .....
207072	11607	Presser Bar Bushing (2) .....
200352c	14198	“ “ “ Set Screw .....
202671	14399	“ “ Lifter .....
200653c	14198	“ “ “ Hinge Screw .....
207963	14399	“ “ Lifting Releasing Lever Bracket .....
200975F	14198	Presser Bar Lifting Releasing Lever Bracket Guide Screw .....
206608	14198	Presser Bar Lifting Releasing Lever Bracket Spring .....
237820	14198	Presser Bar Position Guide .....
202338	14198	“ “ “ “ Lever with 200086F .....
200086F	11607	Presser Bar Position Guide Lever Pinch Screw .....
200352c	14198	Presser Bar Position Guide Set Screw .....

No.	Plate	Name
207965	14414	Presser Bar Spring (flat) .....
210949	14193	“ “ “ Bracket with 200086c .....
200086c	11607	Presser Bar Spring Bracket Pinch Screw .....
200538c	14193	Presser Bar Spring Regulating Screw .....
200948F	14193	Presser Bar Spring Support Screw
201954	—	Roller Presser, $\frac{3}{8}$ in. diam., $\frac{1}{8}$ in. face .....
201955	14193	Roller Presser 201954 with 1528a, 201699c, 350104c and twenty eight 206417 .....
203422	14193	Roller Presser Arm .....
237816	—	“ “ “ 203422 with 201955 .....
202560	14193	Roller Presser Arm Bracket (swing)
237817	—	“ “ “ “ “ with 200096d and 237816 .....
200675F	14193	Roller Presser Arm Bracket Posi- tion Screw Stud .....
202558	14193	Roller Presser Arm Bracket Spring
202559	14193	“ “ “ “ “ Stop .....
200141F	11607	Roller Presser Arm Bracket Spring Stop Screw .....
200096d	14193	Roller Presser Arm Screw .....
206417	14193	“ “ “ Ball, $\frac{3}{8}$ in. diameter
201699c	14193	“ “ “ Cone .....
202557	14192	“ “ “ Bar .....
350104c	14193	“ “ “ Hinge Screw .....
1528a	14193	“ “ “ “ Nut .....
237818	—	Roller Presser and Bar complete, Nos. 200675F, 202557 to 202559, 237817 and two 200141F .....
237762	14193	Take-up Lever .....
202399	14193	“ “ “ Driving Stud with 202277 .....
202277	—	Take-up Lever Driving Stud Oil Packing (wick) .....
202400	14193	Take-up Lever Hinge Stud with 202423 .....
202423	—	Take-up Lever Hinge Stud Oil Packing (wick) .....
200363c	14193	Take-up Lever Hinge Stud Set Screw .....
202401	—	Take-up Lever Oiling Felt .....
200132E	14193	“ “ “ “ Screw..

No.	Plate	Name
244007	11610	Tension Disc (back) .....
207964	14415	" " (front) .....
210950	14193	" Release Driving Lever with 200394c and 202676 .....
202676	14193	Tension Release Driving Lever Pin
237819	14193	" " " " "
		Slide Bar .....
237828	—	Tension Release Driving Lever Pin Slide Bar 237819 with 200167E and 210952 .....
202678	14193	Tension Release Driving Lever Pin Slide Bar Spring .....
200394c	14198	Tension Release Driving Lever Set Screw .....
210951	11610	Tension Release Washer .....
202407	10881	" Spring .....
200625F	11610	" Stud with 204925 .....
200061c	14198	" " Set Screw .....
204925	11610	" " Washer .....
201572B	10881	" Thumb Nut .....
210953	11610	Tension complete, Nos. 200625F, 201572B, 202407, 202682, 207964, 210951 and 244007 .....
202682	11610	Thread Controller Spring .....
210952	11610	" " " Stop .....
200167E	11610	" " " " Screw
202412	14415	" Guide .....
210955	11610	" " (upper) .....
200582H	11610	" " Screw (2) .....
204329	—	" Oiler (felt) .....
237776	14415	" " Bracket with 204329 ...
200582H	11610	" " Screw .....
210956	11610	" Retainer Bracket with 200397H
200582H	11610	" " " Screw (2) ..
202091	14415	" " Sleeve .....
210993	11610	" " " .....
202092	14415	" " Spring .....
223844	14415	" " " .....
204058	14415	" " Stud .....
210957	11610	" " " .....
210958	11610	" " " Collar .....
200366H	14415	" " " Set Screw .....
200397H	11610	" " " " " .....
210959	11610	Thread Retainer (lower) complete, Nos. 210956 to 210958, 210993 and 223844 .....
204059	—	Thread Retainer (upper) complete, Nos. 202091, 202092 and 204058..

No.	Plate	Name
237823	14200	Throat Plate, 53 elongated needle hole, for needle sizes 14 and 15, with 200178D, 200587D, 211416 and 211424, trims opposite the needle and .045 and .085 in. to right of seam .....
211424	14200	Throat Plate Knife Follower .....
200587D	14415	" " " " Screw ..
211416	14200	" " " " Spring
200178D	14415	" " " " "
		Screw .....
6911	14415	Throat Plate Screw (2) .....
237744	14192	Vertical Shaft .....
238670	14415	" " Bevel Gear (lower)
205508	14415	" " " " "
		Position Pin .....
235857	14181	Vertical Shaft Bevel Gear (upper) with 200374c and 200396c .....
200396c	11607	Vertical Shaft Bevel Gear (upper) Position Screw .....
200374c	14181	Vertical Shaft Bevel Gear (upper) Set Screw .....
237734	14181	Vertical Shaft Bushing (lower) ..
200346c	14415	" " " " Set Screw .....
237746	14192	Vertical Shaft Bushing (upper) ..
200362c	14398	" " " " Set Screw .....
237747	14415	Vertical Shaft Driving Gear with 200374c and 200396c .....
200396c	11607	Vertical Shaft Driving Gear Posi- tion Screw .....
200374c	14181	Vertical Shaft Driving Gear Set Screw .....
237754	14415	Vertical Shaft Oil Leader (lower) (brass) .....
237755	14415	Vertical Shaft Oil Leader (upper) (brass) .....



**LIST OF PARTS COMPLETE**  
**FOR**  
**MACHINE No. 110w127**

VERTICAL HOOK. ROLLER PRESSER.  
 CONTINUOUS WHEEL FEED.  
 UNDEREDGE TRIMMER

For Leather Work

No.	Plate	Name
*237801	---	Arm .....
203091	14196	" Cap .....
200278H	14176	" " Screw .....
202248	14176	" " " Washer .....
203089	14196	" " Spool Holder Base .....
203090	14196	" " " " " 203089 with 200079H and 204296 .....
200585H	14187	Arm Cap Spool Holder Base Screw .....
204296	14196	" " " " Wire .....
200079H	14187	" " " " " Hinge Screw .....
203092	---	Arm Cap and Spool Holder complete, Nos. 203090, 203091 and two 200585H .....
204235	14187	Arm Position Pin (2) .....
200004E	14176	" Screw .....
200010E	14176	" " (2) .....
202005	14176	" " Washer (3) .....
202632	14196	" Side Plate .....
200462R	14176	" " " Thumb Screw .....
237802	14414	" Shaft with 200357E and 203100 .....
237748	14196	" " Bushing (back) with 202299 .....
202299	---	Arm Shaft Bushing (back) Oil Packing (wick) .....
200071E	14176	Arm Shaft Bushing (back) Screw (3) .....
207080	14196	Arm Shaft Bushing (front) with 202244 .....
202244	---	Arm Shaft Bushing (front) Oil Packing (wick) .....
200502R	14176	Arm Shaft Bushing (front) Oil Packing Thumb Screw .....

No.	Plate	Name
200338C	14176	Arm Shaft Bushing (front) Set Screw .....
203100	---	Arm Shaft Oil Packing (wick) .....
200357E	14176	" " " " Stop Screw .....
223842	14414	Balance Wheel (belt groove 2 3/4 diam.) with 200328C and 200335C .....
200062H	14176	Balance Wheel Adjusting Screw .....
200328C	14176	" " Position Screw .....
200335C	14176	" " Set Screw .....
*237834	---	Bed .....
237901	14196	" Slide (back) .....
237959	14196	" " (front) .....
203470	14176	Bobbin .....
*203520	---	" Case .....
203648	14176	" " Latch .....
*202056	---	" " " Pin .....
203473	14176	" " " Plunger .....
203474	14176	" " " Spring .....
236078	14176	" " Lever .....
*203476	---	" " " Eccentric .....
204243	14176	" " " " Position Pin .....
235751	14176	" " " Fulcrum .....
200056D	10884	" " " " Screw .....
203478	14176	" " " Slide Stud .....
203214	14176	" " Tension Spring .....
200984C	14176	" " " " Regulat- ing Screw .....
200594C	14176	Bobbin Case Tension Spring Screw .....
203216	-	" " Washer (cloth) .....
203521	14176	Bobbin Case complete, Nos. 200594C, 200984C, 202056, 203214, 203216, 203473, 203474, 203520 and 203648 .....
237804	14414	Face Plate .....
202135	14176	" " Position Pin .....
200473B	14176	" " Thumb Screw .....
237707	14190	Feed Wheel .....
350085E	14398	" " Adjusting Screw .....
237708	14398	" " " " Block .....
238603	14410	" " Bracket with 238630 .....
238604	14410	" " " Plate .....
200158B	14398	" " " " Screw (2) .....
237710	14398	" " " Spring .....
238605	---	" " Driving Gear (for 16 stitches) .....
238606	---	Feed Wheel Driving Gear (for 18 stitches) .....
238607	---	Feed Wheel Driving Gear (for 20 stitches) .....

No.	Plate	Name
238613	14398	Feed Wheel Driving Gear Key . . . .
238614	14398	" " " " " Shifting Collar with 201464c . . . . .
201464c	14187	Feed Wheel Driving Gear Key Shifting Collar Screw Stud . . . . .
238615	14398	Feed Wheel Driving Gear Key Spring . . . . .
201202D	14398	Feed Wheel Driving Gear Key Spring Screw . . . . .
238616	14398	Feed Wheel Driving Gear Key Stop Pin . . . . .
238617	14398	Feed Wheel Driving Gear Separating Washer . . . . .
238618	-----	Feed Wheel Driving Pinion (for 16 stitches) . . . . .
238619	-----	Feed Wheel Driving Pinion (for 18 stitches) . . . . .
238620	-----	Feed Wheel Driving Pinion (for 20 stitches) . . . . .
231433	14398	Feed Wheel Driving Pinion Key . . . . .
238632	14403	" " " " Spacing Washer (for use in place of Feed Wheel Driving Pinion when one or two lengths of stitch are required) . . . . .
238627	14414	Feed Wheel Driving Shaft . . . . .
237722	14410	" " " " Bushing (back) . . . . .
238628	14410	Feed Wheel Driving Shaft Bushing (front) . . . . .
200362c	14398	Feed Wheel Driving Shaft Bushing Set Screw . . . . .
221743	14398	Feed Wheel Driving Shaft Collar with two 200380c . . . . .
200380c	14398	Feed Wheel Driving Shaft Collar Set Screw . . . . .
238669	14414	Feed Wheel Driving Shaft Gear with 200378c and 201220c . . . . .
201220c	14187	Feed Wheel Driving Shaft Gear Position Screw . . . . .
200378c	14398	Feed Wheel Driving Shaft Gear Set Screw . . . . .
201666E	14198	Feed Wheel Driving Shaft Nut . . . . .
203411	14398	" " " " Washer . . . . .
238629	14398	" " Stud with 238616 . . . . .
238630	14398	" " " Bushing . . . . .
238631	14391	" " " Collar with 200152n . . . . .
200152H	14398	" " " " Pinch Screw . . . . .
201697c	14398	" " " Nut . . . . .

No.	Plate	Name
*203482	-----	Hook (sewing) . . . . .
203483	14415	" 203482 with 201253E, 201376E and 203251 . . . . .
203547	-----	Hook and Bobbin Case complete, Nos. 203483 and 203521 . . . . .
238633	14415	Hook Bevel Gear Socket, 13 teeth . . . . .
235527	14181	" " " " Bushing (lower) (brass) . . . . .
200362c	14398	Hook Bevel Gear Socket Bushing (lower) Set Screw . . . . .
235756	14181	Hook Bevel Gear Socket Bushing (upper) (brass) . . . . .
449c	14181	Hook Bevel Gear Socket Bushing (upper) Set Screw . . . . .
200555H	14181	Hook Bevel Gear Socket Screw . . . . .
235635	14181	" " " " Thrust Washer . . . . .
235787	14415	Hook Driving Bevel Gear with two 350089c . . . . .
350089c	14181	Hook Driving Bevel Gear Set Screw . . . . .
237728	14190	" " Shaft . . . . .
235857	14181	" " " Bevel Gear with 200374c and 200396c . . . . .
237729	14414	Hook Driving Shaft Bevel Gear Housing with 200346c and three 200362c . . . . .
237730	14410	Hook Driving Shaft Bevel Gear Housing Cap (bottom) . . . . .
237731	14410	Hook Driving Shaft Bevel Gear Housing Cap (bottom) Gasket . . . . .
237732	14410	Hook Driving Shaft Bevel Gear Housing Cap (side) . . . . .
237733	14410	Hook Driving Shaft Bevel Gear Housing Cap (side) Gasket . . . . .
200053c	14181	Hook Driving Shaft Bevel Gear Housing Cap Screw (4) . . . . .
201082E	14181	Hook Driving Shaft Bevel Gear Housing Screw (long) . . . . .
225532	14187	Hook Driving Shaft Bevel Gear Housing Screw (long) Washer . . . . .
201308E	14181	Hook Driving Shaft Bevel Gear Housing Screw (short) . . . . .
200396c	11607	Hook Driving Shaft Bevel Gear Position Screw . . . . .
200374c	14181	Hook Driving Shaft Bevel Gear Set Screw . . . . .
237734	14181	Hook Driving Shaft Bushing (back) . . . . .
200362c	14398	" " " " " Set Screw . . . . .

No.	Plate	Name
235531	14181	Hook Driving Shaft Bushing (front)
200347c	14181	" " " " " "
		Set Screw .....
221743	14398	Hook Driving Shaft Collar with two 200380c .....
200380c	14398	Hook Driving Shaft Collar Set Screw .....
203251	14415	Hook Gib .....
201376F	14181	" " Hinge Screw .....
201253F	14181	" " Screw .....
237735	14414	" Saddle with 449c, 200347c and three 200362c .....
235534	14410	Hook Saddle Oil Cover .....
201185D	14399	" " " " Screw (2) ..
201318E	14399	" " " Stop Screw (2) ..
235535	---	" " Oiling Felt .....
202260	---	" " " Wick .....
235649	14399	" " " " Cover .....
200169H	14399	" " " " " Screw
201308E	14181	" " Screw (2) .....
203637	---	" " Washer (2) .....
213018	14399	" Washer with 203476 and two 204243 .....
237837	14414	Knee Lifter Connection Lever ....
200262H	14399	" " " " Hinge Screw .....
237766	14190	Knee Lifter Connection Lever Lift- ing Rod with 202302 .....
202302	14399	Knee Lifter Connection Lever Lift- ing Rod Cotter Pin .....
237838	14414	Knee Lifter Lifting Lever .....
200262H	14399	" " " " Hinge Screw .....
207807	14187	Knife .....
200368H	14187	" Adjusting Screw .....
237932	14190	" Bar .....
237807	14187	" " Angle Extension .....
200126E	14187	" " " " Screw (2)
221417	14190	" " Driving Eccentric with 200382c and 200437c .....
202890	14190	Knife Bar Driving Eccentric Fork with 200382c and 201464c .....
201464c	14187	Knife Bar Driving Eccentric Fork Position Screw .....
200382c	14198	Knife Bar Driving Eccentric Fork Set Screw .....
200437c	14187	Knife Bar Driving Eccentric Posi- tion Screw .....
200382c	14198	Knife Bar Driving Eccentric Set Screw .....

No.	Plate	Name
202891	14192	Knife Bar Driving Shaft Crank with 200694F and 201525E .....
203244	14187	Knife Bar Driving Shaft Crank Collar with two 200393c .....
200393c	14187	Knife Bar Driving Shaft Crank Collar Set Screw .....
200694F	14187	Knife Bar Driving Shaft Crank Screw Stud .....
201525E	14187	Knife Bar Driving Shaft Crank Screw Stud Nut .....
237907	14187	Knife Bar Guide Block .....
200011D	14187	" " " " Screw (2) ..
200404c	14187	" " " Screw .....
201531E	14187	" " " " Nut .....
237829	14187	" " Lifting Spring .....
202346	14187	" " " " Plunger ..
237908	14198	" " Position Bracket .....
201387F	14198	" " " " Screw (2) .....
237933	14198	Knife Holder with 200368H .....
200898D	14198	" " Screw .....
237939	14198	" " Switch-in Handle ....
200076D	14198	" Screw (2) .....
237812	14192	" Switch-out Handle with two 200403c .....
200403c	14403	Knife Switch-out Handle Set Screw
202899	14192	" " " Shaft ....
202900	14198	" " " Spring (spiral) .....
237937	14399	Needle Bar with 200141E .....
202352	11607	" " Connecting Link .....
236073	14399	" " " " Oil Guard .....
200161D	11607	Needle Bar Connecting Link Oil Guard Screw .....
202333	11607	Needle Bar Connecting Link Stud with 202254 .....
202254	---	Needle Bar Connecting Link Stud Oil Packing (wick) .....
200374c	14181	Needle Bar Connecting Link Stud Set Screw .....
200383c	14399	Needle Bar Connecting Link Stud Set Screw .....
*206891	---	Needle Bar Connecting Stud .....
202329	11607	" " " " 206891 with 200086c and 202330 .....
202330	---	Needle Bar Connecting Stud Oil Packing (wick) .....
200086c	11607	Needle Bar Connecting Stud Pinch Screw .....

No.	Plate	Name
202692	14192	Needle Bar Crank with 200335c, 200374c, 200383c, 200428c and 202333 .....
237737	—	Needle Bar Crank 202692 with 202329, 202399, 202400, 202552 and 237762 .....
203172	11607	Needle Bar Crank Friction Washer
200428c	11607	" " " Position Screw ..
200335c	14176	" " " Set Screw .....
237813	14192	" " " Rock Frame .....
237931	—	" " " " 237813 with 237937 .....
*38127	—	Needle Bar Rock Frame Driving Eccentric .....
*237749	—	Needle Bar Rock Frame Driving Eccentric Body .....
350107c	14399	Needle Bar Rock Frame Driving Eccentric Body Position Screw ..
443c	14399	Needle Bar Rock Frame Driving Eccentric Body Set Screw .....
1103c	14399	Needle Bar Rock Frame Driving Eccentric Regulating Screw ....
217d	14399	Needle Bar Rock Frame Driving Eccentric Set Screw .....
7071	14399	Needle Bar Rock Frame Driving Eccentric Set Screw Washer ...
237750	—	Needle Bar Rock Frame Driving Eccentric complete, Nos. 217d, 443c, 1103c, 7071, 38127, 237749 and 350107c .....
237739	14192	Needle Bar Rock Frame Driving Fork Lever with 200029f .....
200029f	14399	Needle Bar Rock Frame Driving Fork Lever Pinch Screw .....
237740	14403	Needle Bar Rock Frame Driving Fork Lever Slide Block (two pieces) .....
210910	11607	Needle Bar Rock Frame Hinge Stud with 202277 .....
202277	—	Needle Bar Rock Frame Hinge Stud Oil Packing (wick) .....
200347c	14181	Needle Bar Rock Frame Hinge Stud Set Screw .....
202667	14192	Needle Bar Rock Frame Rock Shaft
210978	—	" " " " " " " " 202667 with 200386c and 210920 ..
237910	14198	Needle Bar Rock Frame Position Bracket with 200404c and 201531E
350129E	14198	Needle Bar Rock Frame Position Bracket Screw (2) .....

No.	Plate	Name
202668	11607	Needle Bar Rock Frame Slide Block
210920	—	" " " " " " " " 202668 with 201141c .....
201141c	14399	Needle Bar Rock Frame Slide Block Screw Stud .....
200386c	14415	Needle Bar Rock Frame Slide Block Screw Stud Set Screw .....
200141f	11607	Needle Set Screw .....
207072	11607	Presser Bar Bushing (2) .....
200352c	14198	" " " " Set Screw (2) ..
202671	14399	" " " Lifter .....
200653c	14198	" " " Hinge Screw ....
207963	14399	" " " Lifting Releasing Lever Bracket .....
200975f	14198	Presser Bar Lifting Releasing Lever Bracket Guide Screw .....
206608	14198	Presser Bar Lifting Releasing Lever Bracket Spring .....
237820	14198	Presser Bar Position Guide .....
202338	14198	" " " " " Lever with 200086f .....
200086f	11607	Presser Bar Position Guide Lever Pinch Screw .....
200352c	14198	Presser Bar Position Guide Set Screw .....
207965	14414	Presser Bar Spring (flat) .....
210949	14193	" " " " Bracket with 200086c .....
200086c	11607	Presser Bar Spring Bracket Pinch Screw .....
200538c	14193	Presser Bar Spring Regulating Screw .....
200948f	14193	Presser Bar Spring Support Screw
201954	—	Roller Presser, $\frac{3}{8}$ in. diam., $\frac{1}{2}$ in. face .....
201955	14193	Roller Presser 201954 with 1528a, 201699c, 350104c and twenty-eight 206417 .....
203422	14193	Roller Presser Arm .....
237816	—	" " " " 203422 with 201955 .....
202560	14193	Roller Presser Arm Bracket (swing)
237817	—	" " " " " 202560 with 200096b and 237816 .....
200675f	14193	Roller Presser Arm Bracket Position Screw Stud .....
202558	14193	Roller Presser Arm Bracket Spring
202559	14193	" " " " " " " " Stop .....



No.	Plate	Name
225459	10884	Stop Latch Thumb Lever Hinge Stud .....
225459	10884	Stop Latch Thumb Lever Joint Stud
202478	10884	" " Trip Lever .....
200299H	10884	" " " " Hinge Screw
225461	10881	Tension Bracket with 201499B ....
200082D	10881	" " Screw .....
228026	10884	" " Washer .....
2102	10881	" Disc .....
202407	10881	" Spring .....
201499B	10881	" Stud .....
201572B	10881	" " Thumb Nut .....
225462	10881	Bobbin Winder Tension Bracket complete, Nos. 201572B, 202407, 225461 and two 2102 .....
225433	10885	Bobbin Winder and Tension Bracket Base .....
225382	10885	Universal Bobbin Winder complete, Nos. 200056E, 200082D, 200299H, 202473, 202478, 225381, 225433, 225444, 225453 to 225456, 225458, 225462, 228026, two each 225459 and wood screws $\frac{3}{4}$ in., No. 12, R.H.B. ....

## KNEE LIFTER

2763	14407	Rock Shaft .....
7539	14407	" " Hanger (back) with two wood screws 1 in., No. 10 ..
20093	14407	Rock Shaft Hanger (front) with two wood screws 1 in., No. 10 ..
228562	14407	Rock Shaft Knee Arm .....
228563	—	Rock Shaft Knee Arm complete, Nos. 1507R, 2766, 2767 and 228562
2766	14407	Rock Shaft Knee Arm Hub with 356c .....
356c	14407	Rock Shaft Knee Arm Hub Set Screw .....
1507R	14407	Rock Shaft Knee Arm Lock Nut ..
2767	14407	" " " Plate with 356c ..
228255	14407	" " " " Counter-balance Spring .....
356c	14407	Rock Shaft Knee Plate Set Screw
228238	14407	" " Lifting Lever with 356c
228239	—	" " " " 228238 with 8073, 204225, 228240 and 228241 ..
228240	14407	Rock Shaft Lifting Lever Rod (3 in. long) .....

No.	Plate	Name
200529c	14407	Rock Shaft Lifting Lever Rod Set Screw .....
228241	14407	Rock Shaft Lifting Lever Rod Swivel with 200529c .....
204225	14407	Rock Shaft Lifting Lever Rod Swivel Spring .....
8073	14407	Rock Shaft Lifting Lever Rod Swivel Spring Plunger .....
356c	14407	Rock Shaft Lifting Lever Set Screw
2770	14407	" " Stop Dog with 356c ...
356c	14407	" " " " Set Screw ..
228243	14407	Rock Shaft complete, Nos. 2763, 7539, 20093, 228239, 228255, 228563, Form A 1079 and two 2770 .....

(Other Knee Lifter parts are listed with parts of machine head.)

## FEED GEARS

238641	—	Feed Wheel Driving Gear (for 12 stitches) .....
238642	—	Feed Wheel Driving Gear (for 14 stitches) .....
238643	—	Feed Wheel Driving Gear (for 15 stitches) .....
238605	—	Feed Wheel Driving Gear (for 16 stitches) .....
238606	—	Feed Wheel Driving Gear (for 18 stitches) .....
238607	—	Feed Wheel Driving Gear (for 20 stitches) .....
238608	—	Feed Wheel Driving Gear (for 21 stitches) .....
238609	14403	Feed Wheel Driving Gear (for 22 stitches) .....
238610	—	Feed Wheel Driving Gear (for 24 stitches) .....
238611	—	Feed Wheel Driving Gear (for 25 stitches) .....
238651	—	Feed Wheel Driving Gear (for 27 stitches) .....
238612	—	Feed Wheel Driving Gear (for 29 stitches) .....
238653	—	Feed Wheel Driving Gear (for 31 stitches) .....
238654	—	Feed Wheel Driving Gear (for 33 stitches) .....

No.	Plate	Name
238655	—	Feed Wheel Driving Pinion (for 12 stitches) .....
238656	—	Feed Wheel Driving Pinion (for 14 stitches) .....
238657	—	Feed Wheel Driving Pinion (for 15 stitches) .....
238618	—	Feed Wheel Driving Pinion (for 16 stitches) .....
238619	—	Feed Wheel Driving Pinion (for 18 stitches) .....
238620	—	Feed Wheel Driving Pinion (for 20 stitches) .....
238621	—	Feed Wheel Driving Pinion (for 21 stitches) .....
238622	14403	Feed Wheel Driving Pinion (for 22 stitches) .....
238623	—	Feed Wheel Driving Pinion (for 24 stitches) .....
238624	—	Feed Wheel Driving Pinion (for 25 stitches) .....
238665	—	Feed Wheel Driving Pinion (for 27 stitches) .....
238625	—	Feed Wheel Driving Pinion (for 29 stitches) .....
238667	—	Feed Wheel Driving Pinion (for 31 stitches) .....
238668	—	Feed Wheel Driving Pinion (for 33 stitches) .....

## FEED WHEELS

237707	14190	Feed Wheel .....
237767	14382	" " (coarse) .....
237771	14382	" " (knurled) .....
238523	14382	" " .....

## GUIDES

FOR MACHINE No. 110w127

237902	14188	Guide Bed with 26550 .....
200397H	11610	" " Adjusting Screw .....
237938	14188	" Finger to trim back of needle .....
26756	14188	" " " " opposite the needle .....

No.	Plate	Name
26543	—	Guide Finger Carrier .....
1073J	14188	" " " " Regulating Thumb Screw .....
1550J	14188	Guide Finger Carrier Regulating Thumb Screw Nut .....
50009J	14188	Guide Finger Carrier Screw .....
35777	14188	" " " " Friction Plate .....
26544	14188	Guide Finger Carrier complete, Nos. 1075E, 26543, 26546 and three 2523 .....
26546	—	Guide Finger Position Plate .....
2523	14188	" " " " Rivet ..
219J	14188	" " Screw .....
1075E	14415	" Regulating Screw Stud .....
1536J	14188	" " Thumb Nut .....
200907B	14188	" Screw .....
26547	14188	" Slide .....
26548	14188	" " Latch .....
26549	14188	" " " Cap with 2081 ...
50169J	14188	" " " " Screw .....
2975	14188	" " " Spring .....
2081	14188	" " " Stop Pin .....
26550	—	" " " Stud .....
26551	14188	" " Spring .....
1074E	14188	" " Stop Stud .....
237903	14188	" Swing Base with two 200397H .....
200246B	14187	" " " Hinge Screw ...
201525E	14187	" " " " " Nut .....
225708	14187	" " " Spring .....
237905	14190	Guide (adjustable), for trimming back of needle, complete, Nos. 219J, 1073J, 1074E, 1536J, 1550J, 2975, 26544, 26547 to 26549, 26551, 35777, 50009J, 200246B, 201525E, 225708, 237902, 237903, 237938, two each 50169J and 200907B ...
237904	—	Guide (adjustable), for trimming opposite the needle, complete, Nos. 219J, 1073J, 1074E, 1536J, 1550J, 2975, 26544, 26547 to 26549, 26551, 26756, 35777, 50009J, 200246B, 201525E, 225708, 237902, 237903, two each 50169J and 200907B .....

## THROAT PLATES

FOR MACHINE No. 110w126

No.	Plate	Name
(237823) 237863	14200	Throat Plate, 53 elongated needle hole, for needle sizes 14 and 15, with 200178D, 200587D, 211416 and 211426, trims opposite the needle and .045 and .085 in. to right of seam .....

FOR MACHINE No. 110w127

237940	—	Throat Plate Body, for trimming opposite the needle and .040 and .050 in. to right of seam, for 237946 and 237947 .....
237941	—	Throat Plate Body, for trimming opposite the needle and .060 and .075 in. to right of seam, for 237948 and 237949 .....
237950	—	Throat Plate Body, for trimming back on needle and .015 and .025 in. to right of seam, for 237956 and 237957 .....
237951	—	Throat Plate Body, for trimming back of needle and .040 and .050 in. to right of seam, for 237958 ..
237942	14200	Throat Plate Knife Cutting Bar, 56 elongated needle hole, for needle sizes 12 and 13, trims opposite the needle and .040 in. to right of seam, for 237946 .....
237943	—	Throat Plate Knife Cutting Bar, 56 elongated needle hole, for needle sizes 12 and 13, trims opposite the needle and .050 in. to right of seam, for 237947 .....
237944	—	Throat Plate Knife Cutting Bar, 56 elongated needle hole, for needle sizes 12 and 13, trims opposite the needle and .060 in. to right of seam, for 237948 .....

No.	Plate	Name
237945	—	Throat Plate Knife Cutting Bar, 56 elongated needle hole, for needle sizes 12 and 13, trims opposite the needle and .075 in. to right of seam, for 237949 .....
237952	—	Throat Plate Knife Cutting Bar, 56 elongated needle hole, for needle sizes 12 and 13, trims back of needle and .015 in. to right of seam, for 237956 .....
237953	—	Throat Plate Knife Cutting Bar, 56 elongated needle hole, for needle sizes 12 and 13, trims back of needle and .025 in. to right of seam, for 237957 .....
237954	14200	Throat Plate Knife Cutting Bar, 56 elongated needle hole, for needle sizes 12 and 13, trims back of needle and .040 in. to right of seam, for 237958 .....
237946	14200	Throat Plate complete, 56 elongated needle hole, for needle sizes 12 and 13, trims opposite the needle and .040 in. to right of seam, Nos. 237940, 237942 and two 200583π..
237947	—	Throat Plate complete, 56 elongated needle hole, for needle sizes 12 and 13, trims opposite the needle and .050 in. to right of seam, Nos. 237940, 237943 and two 200583π ..
237948	—	Throat Plate complete, 56 elongated needle hole, for needle sizes 12 and 13, trims opposite the needle and .060 in. to right of seam, Nos. 237941, 237944 and two 200583π..
237949	—	Throat Plate complete, 56 elongated needle hole, for needle sizes 12 and 13, trims opposite the needle and .075 in. to right of seam, Nos. 237941, 237945 and two 200583π..
237956	—	Throat Plate complete, 56 elongated needle hole, for needle sizes 12 and 13, trims back of needle and .015 in. to right of seam, Nos. 237950, 237952 and two 200583π..
237957	—	Throat Plate complete, 56 elongated needle hole, for needle sizes 12 and 13, trims back of needle and .025 in. to right of seam, Nos. 237950, 237953 and two 200583π..



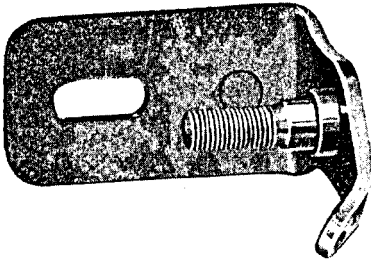
No.	Plate	Name
237958	14200	Throat Plate complete, 56 elongated needle hole, for needle sizes 12 and 13, trims back of needle and .040 in. to right of seam, Nos. 237951, 237954 and two 200583H..

## OBSOLETE PARTS

235755	14181	Hook Bevel Gear Socket, 18 teeth
235529	14181	" Driving Bevel Gear with two 350089c .....

PLATE 10881—FULL SIZE

225461



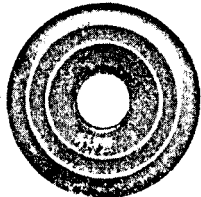
200082



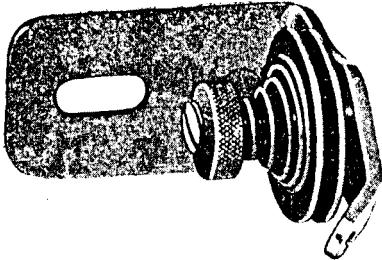
202104



2102



225462



202407



201499

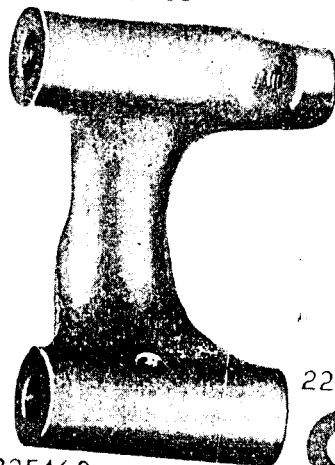


201572

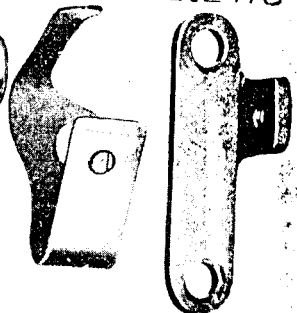


PLATE 10884—FULL SIZE

225453

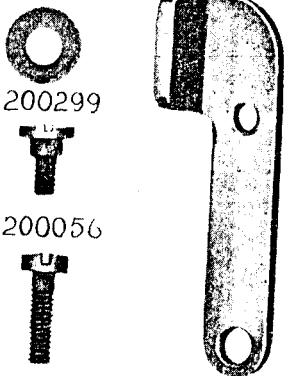


225444 202478



228026

225458



225460

225454

200299



225438

200056



225459

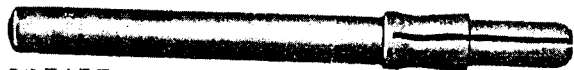


200105

225456



225381

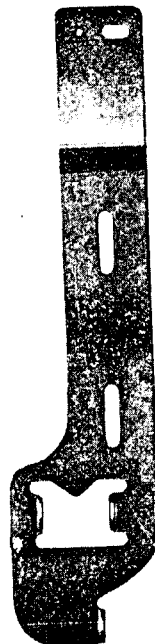


225455



PLATE 10885—ONE-FOURTH SIZE

225433



202473

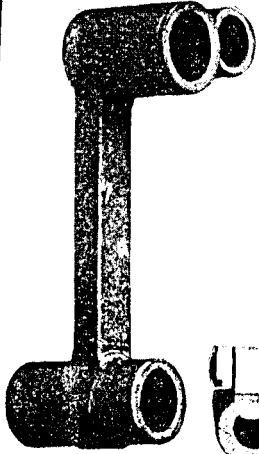


225382



PLATE 11607 - FULL SIZE

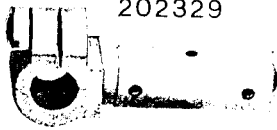
202552



200161



202329



202333



200428



203172



200086



202666



200098



202668



207072



200141



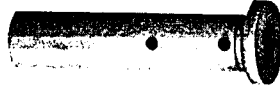
200822



200386



210910



200396



PLATE 11610 - FULL SIZE

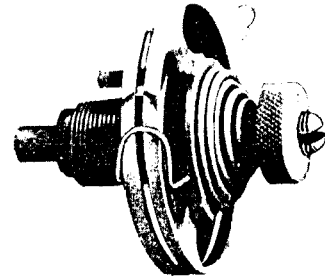
200625



210951



210953



244007



210967



202407



201572



204925



210992



210959



202682

210958



210993

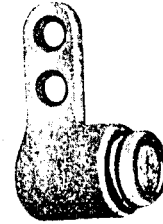


210959

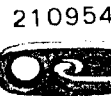
210957



210963

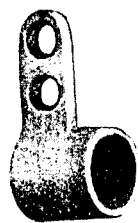


210952



210954

210956



210955

210960



210961



210962



200582



200389



200081



200167



200397



PLATE 14176—FULL SIZE

200278 202248 200071 202036 200338

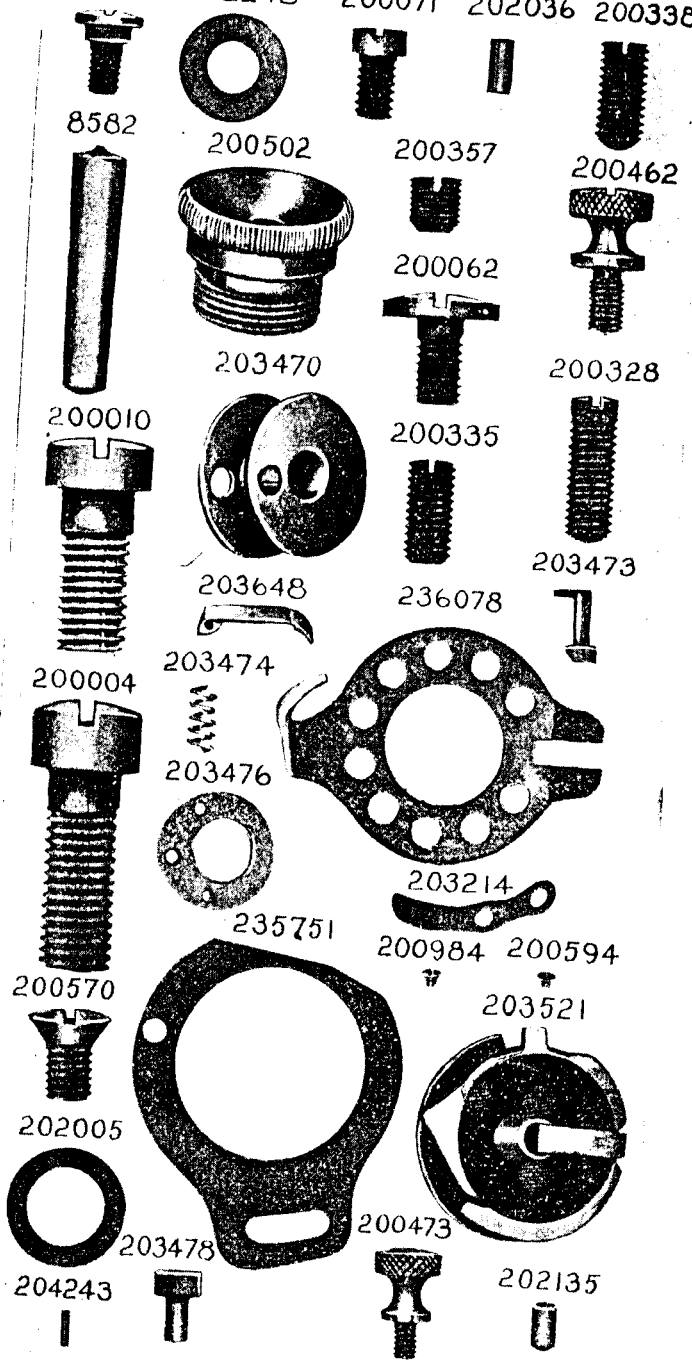


PLATE 14181—FULL SIZE

237726 235527 235756

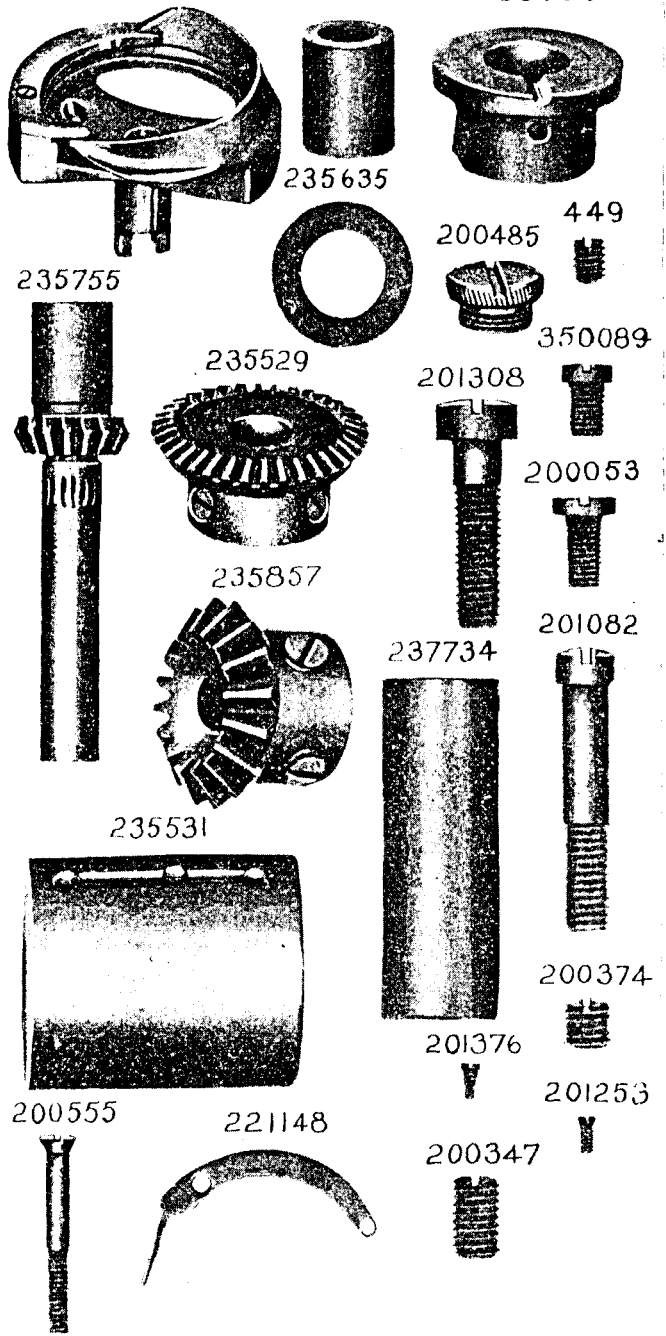


PLATE 14187—FULL SIZE

PLATE 14188—FULL SIZE

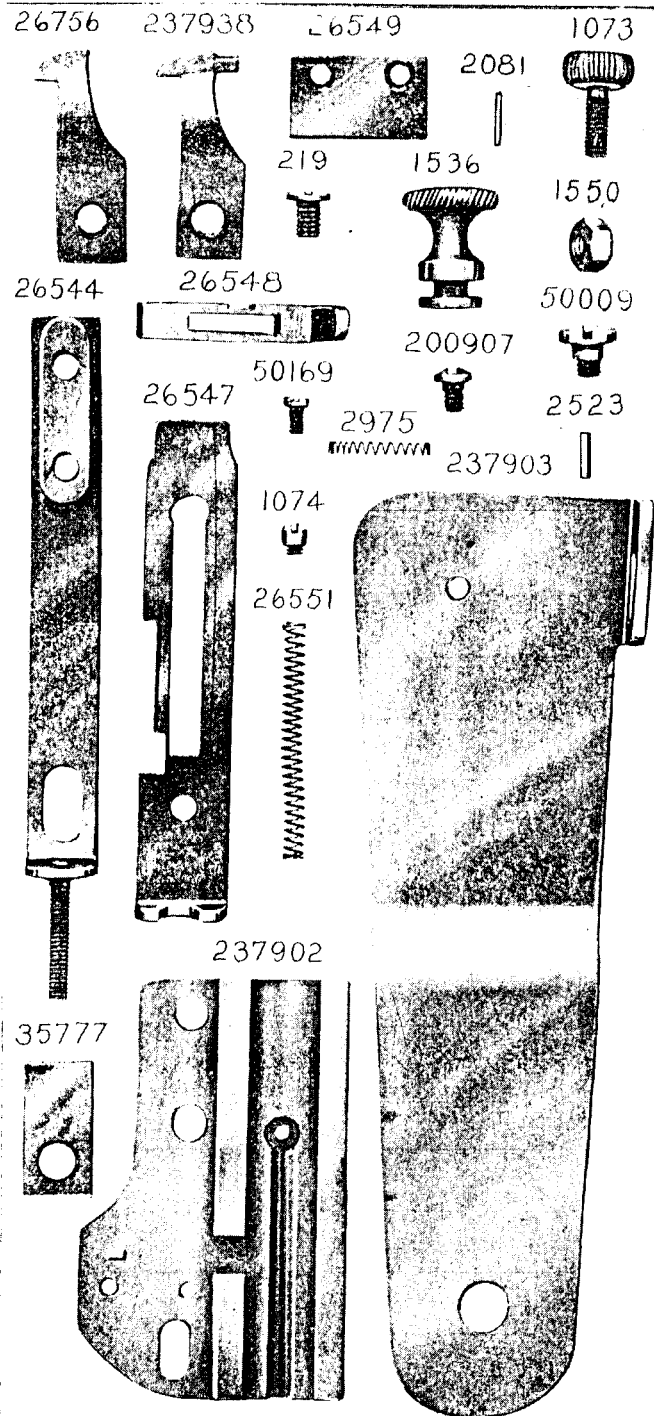
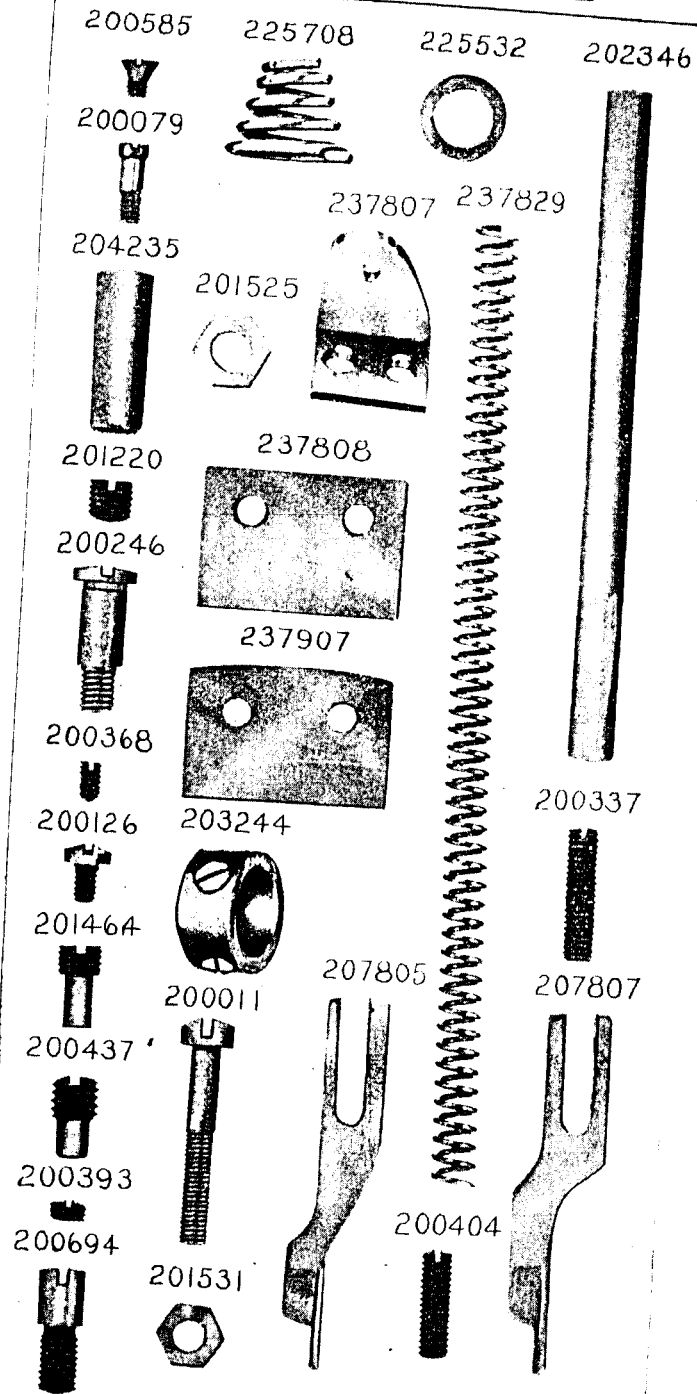
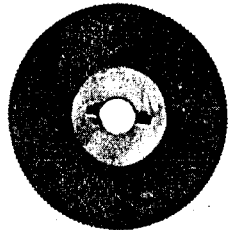


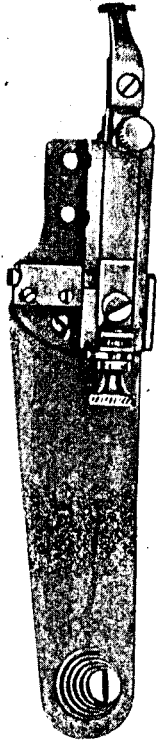
PLATE 14190—ONE-HALF SIZE

237707  
237767 237728

237766



237905



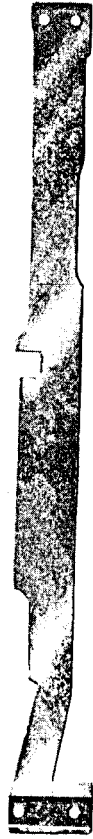
221417



237806



237932



208490



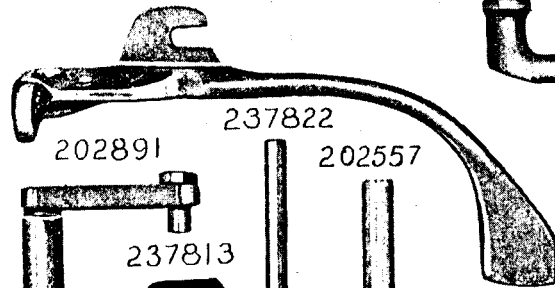
202890



PLATE 14192—ONE-HALF SIZE

237812

202667

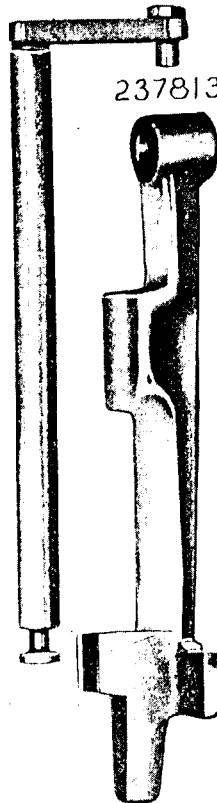


202891

237822

202557

237813



237744

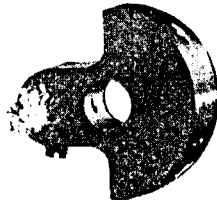
202899



237746



202692



237739

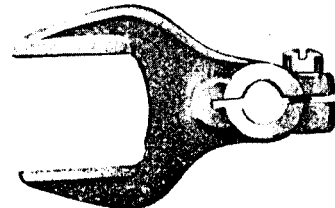


PLATE 14193—FULL SIZE

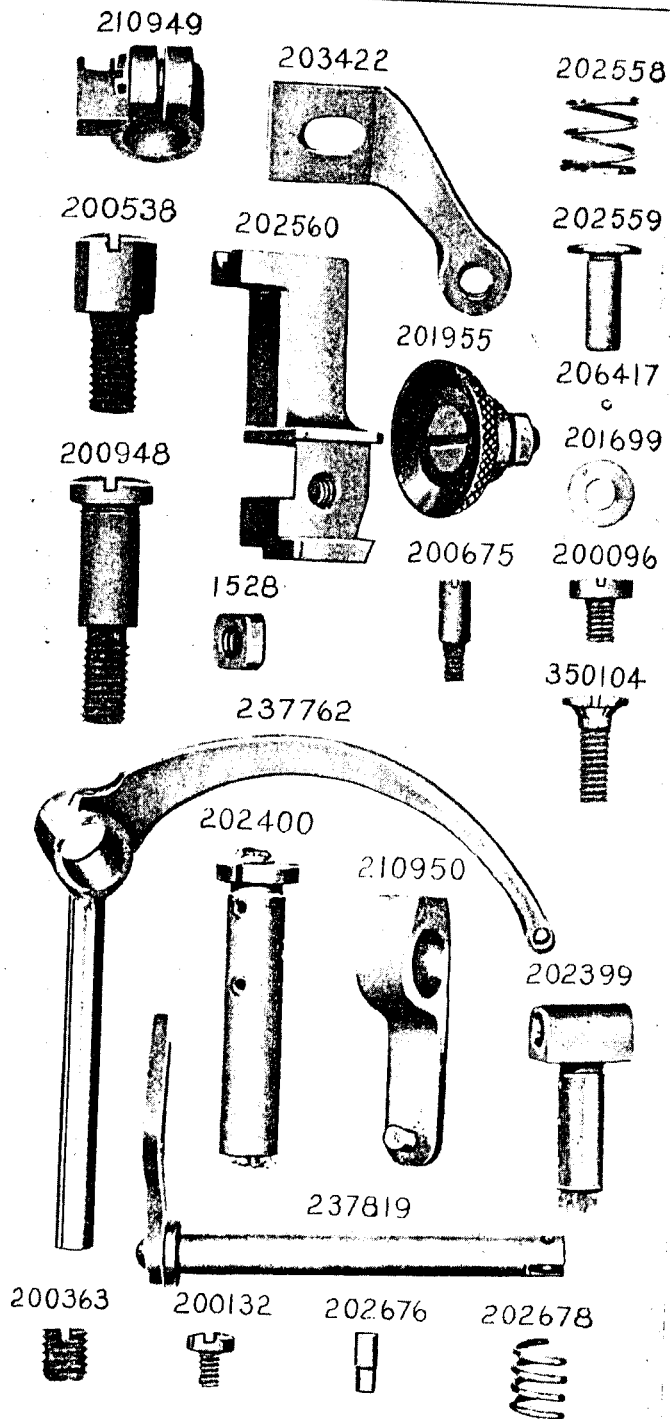


PLATE 14196—ONE-HALF SIZE

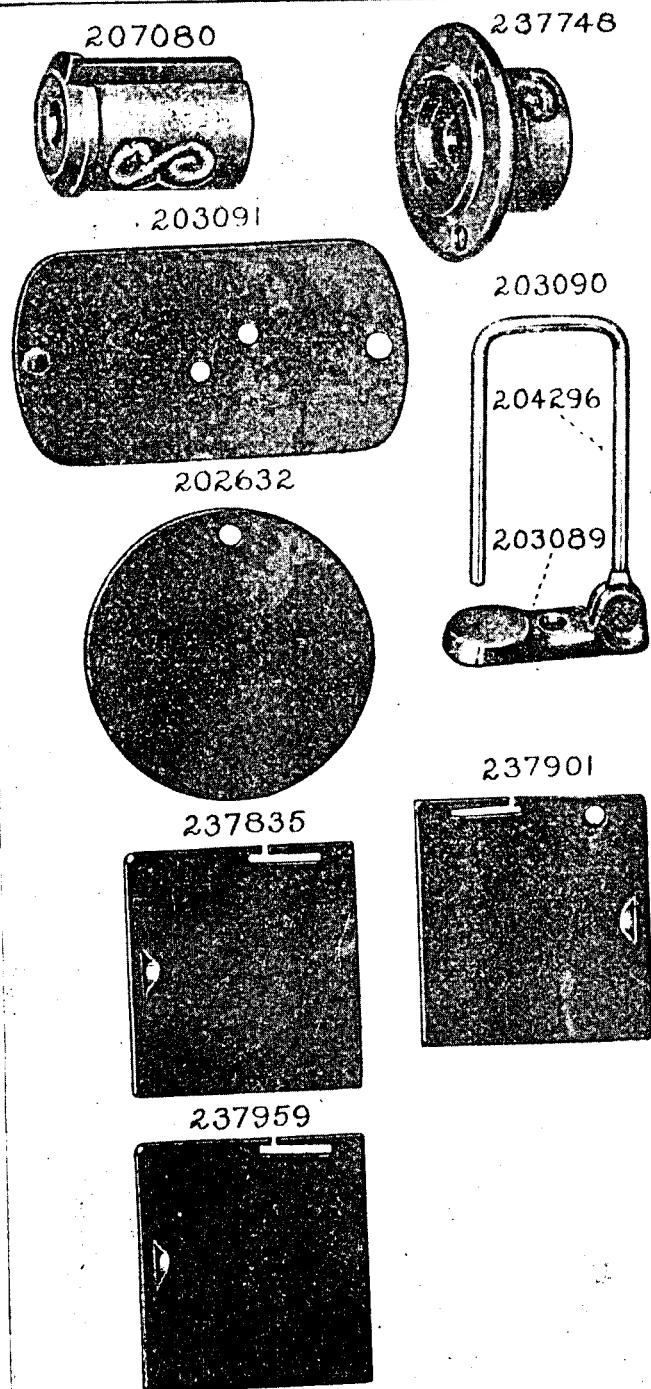




PLATE 14198—FULL SIZE

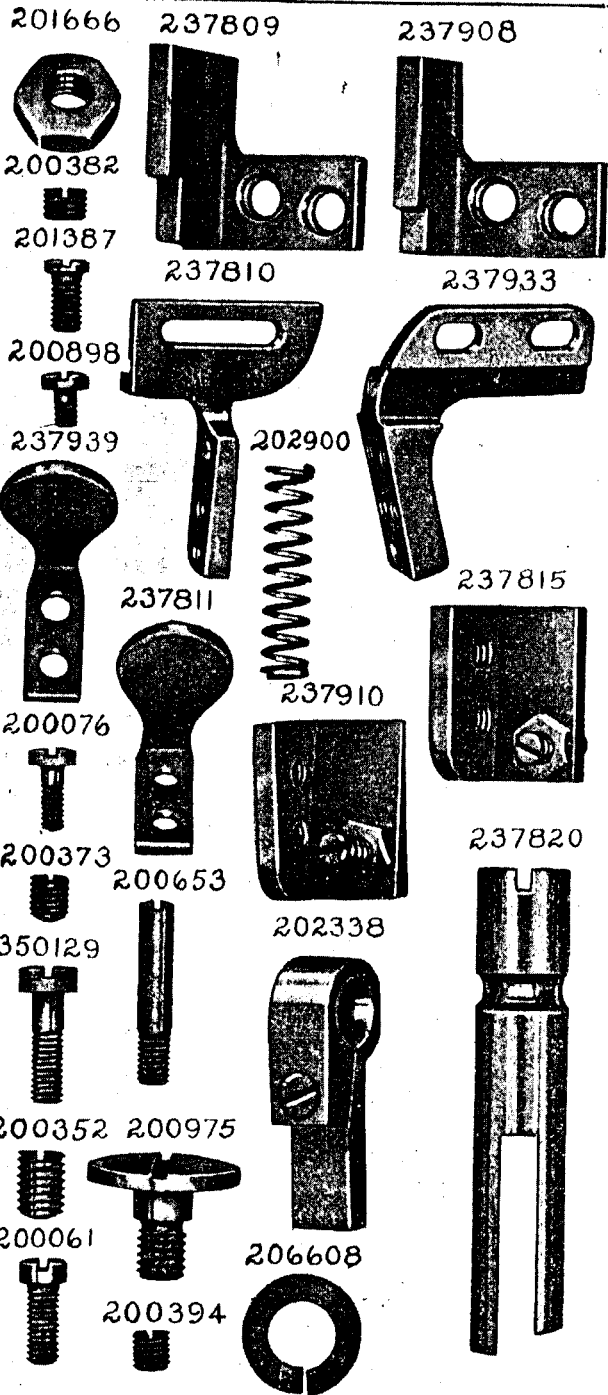


PLATE 14200—FULL SIZE

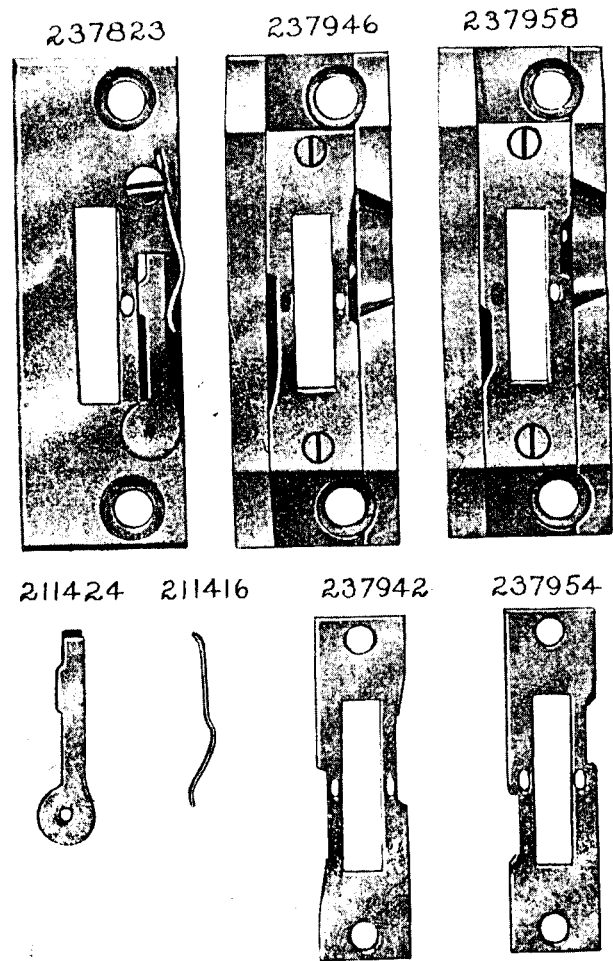
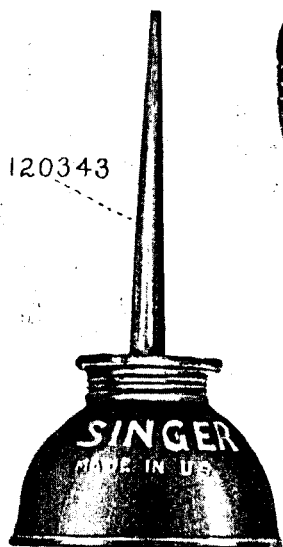


PLATE 14334—ONE-HALF SIZE

120342

225498

225497



225554



12361

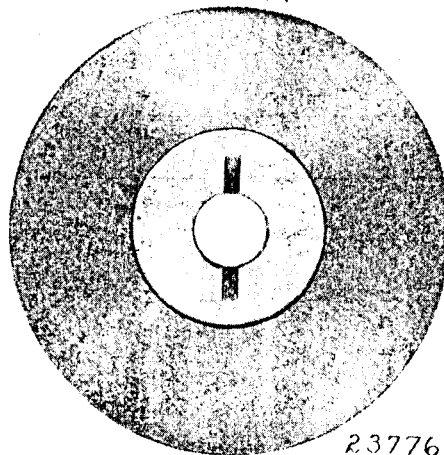


41400

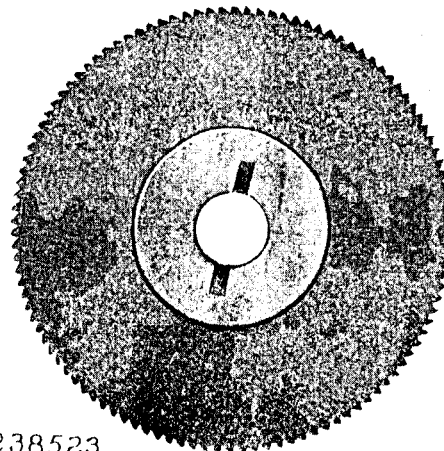


PLATE 14382—FULL SIZE

237771



237767



238523

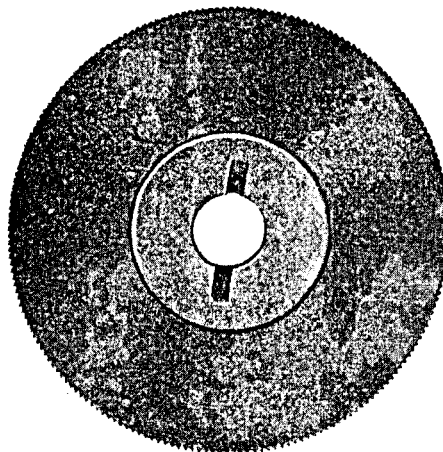
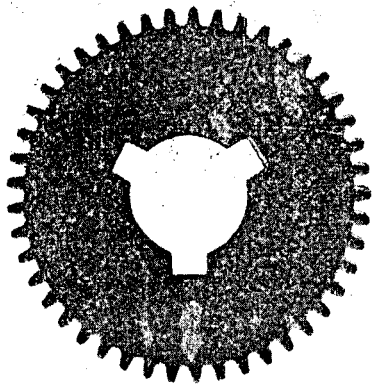
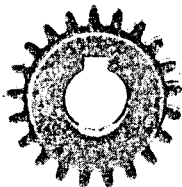


PLATE 14403—FULL SIZE

238609



238622



238632



200522



200526



200529



200157



4822



202452



200861



237740

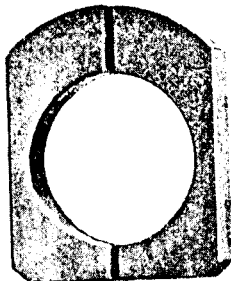
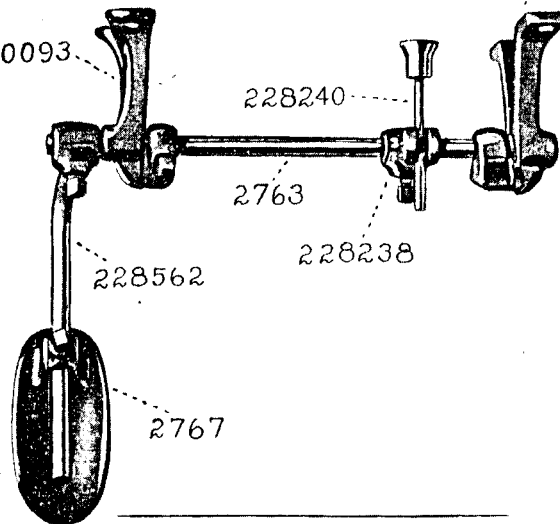


PLATE 14407—ONE-FOURTH SIZE

228243

7539

20093



228240

2763

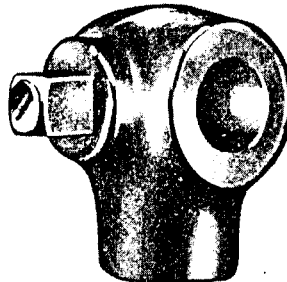
228562

228238

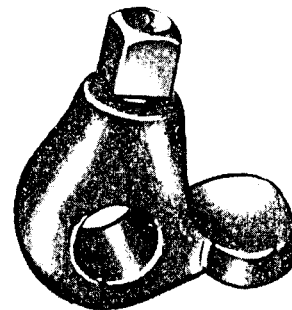
2767

FULL SIZE

2766



2770



200529



228241

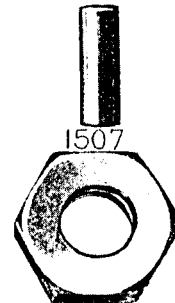


8073

204225



1507



356

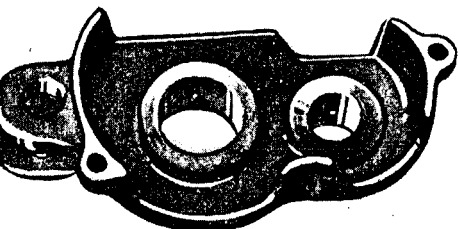


228255



PLATE 14410—ONE-HALF SIZE

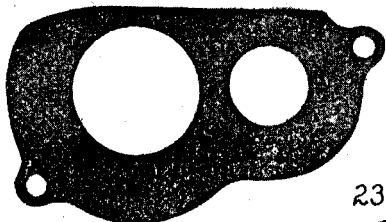
238603



237722



238604

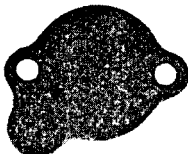


238628

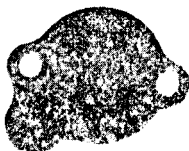
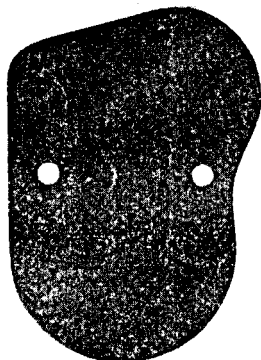


237732

237730

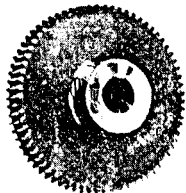


237731



238669

237733



235534

