

SINGER
110W100

INDEX

COPYRIGHT, U.S.A., 1919 and 1922, BY THE SINGER MANUFACTURING CO.
ALL RIGHTS RESERVED FOR ALL COUNTRIES

	PAGE
ACCESSORIES	17
BOBBIN WINDER	17
FEED GEARS	20
KNEE LIFTER	18
MACHINE No. 110w100	7
NUMERICAL LIST OF PARTS	21

Instructions for Ordering

In ordering from this list, use **ONLY** the **PART** number in the **FIRST** column.

The number stamped on a Sewing Machine Part is the number of the Single Part only, except when the part includes Set Screws, Clamping Screws, Studs and Rollers Spun on, Small Wire-riveted, or Parts soldered together, etc., which it is necessary to furnish in combination.

Every combination of parts sent out has its specific number which, although not stamped on Parts (except in above cases) must be used when ordering the combination.

Each number always indicates the **SAME PART** in whatever list it appears, or for whatever Machine.

The letters after some of the numbers indicate the style of finish only, as follows:

- A. Hardened, Polished and Plated.
- B. Polished and Plated.
- C. Hardened only.
- D. Polished only.
- E. Soft, not polished.
- F. Hardened and Polished.
- H. Blued.

These letters **MUST BE USED** when they appear in the list and **AFTER** the number, as in the list.

In this series

- 200001 to 201500 are Screw Numbers.
- 201501 to 201800 are Nut Numbers.
- 201801 to 202000 are Roller Numbers.
- 202001 and upward are numbers of Machine Parts.

The figures in the second column refer only to the plate in which the illustration of the part is shown and are **NOT TO BE USED** in ordering.

Two or more numbers over a cut indicate that the difference between such parts is not visible in an illustration.

Parts marked with an asterisk (*) are furnished only when repairs are made at the factory.

LIST OF PARTS COMPLETE

FOR

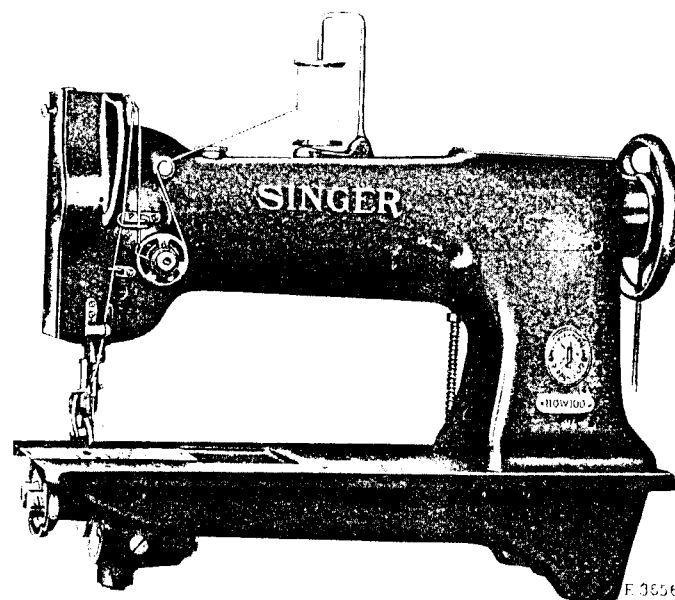

F. 3556

MACHINE No. 110w100

VERTICAL HOOK. ROLLER PRESSER.

CONTINUOUS WHEEL FEED

For Leather Work

No.	Plate	Name
*237701	---	Arm
202247	14177	" Cap
200278H	14176	" " Screw
202248	14176	" " " Washer
8582	14176	" Position Pin (2)
200010E	14176	" Screw (2)
200004E	14176	" "
202005	14176	" " Washer (3)
237702	14178	" Shaft with 200357E and 203100
237748	14177	" " Bushing (back) with
		202299

No.	Plate	Name
202299	—	Arm Shaft Bushing (back) Oil Packing (wick)
200071E	14176	Arm Shaft Bushing (back) Screw (3)
202245	14177	Arm Shaft Bushing (front) with 202036 and 202260
202260	—	Arm Shaft Bushing (front) Oil Packing (wick)
200502B	14176	Arm Shaft Bushing (front) Oil Packing Thumb Screw
202036	14176	Arm Shaft Bushing (front) Position Pin
200338c	14176	Arm Shaft Bushing (front) Set Screw
203100	—	Arm Shaft Oil Packing (wick) ...
200357E	14176	" " " " Stop Screw ..
202632	14177	" Side Plate
200462B	14176	" " " Thumb Screw
223842	14178	Balance Wheel (belt groove 2 $\frac{3}{4}$ in. diam.) with 200328c and 200335c
200062H	14176	Balance Wheel Adjusting Screw ..
200328c	14176	" " Position Screw ...
200335c	14176	" " Set Screw
*237705	—	Bed
202258	12345	" Hinge Connection (2)
200570E	14176	" " " Screw (4)
213750	14177	" Slide (back)
237706	14177	" " (front)
203470	14176	Bobbin
*203520	—	" Case
203648	14176	" " Latch
*202056	—	" " " Pin
203473	14176	" " " Plunger
203474	14176	" " " Spring
236078	14176	" " Lever
203476	14176	" " " Eccentric
204243	14176	" " " Position Pin
235751	14176	" " " Fulcrum
200056D	10882	" " " Screw
203478	14176	" " " Slide Stud
203214	14176	" " Tension Spring
200984c	14176	" " " " Regulat- ing Screw
200594c	14176	Bobbin Case Tension Spring Screw
203216	—	" " Washer (cloth)
203521	14176	Bobbin Case complete, Nos. 200594c, 200984c, 202056, 203214, 203216, 203473, 203474, 203520 and 203648

235751

No.	Plate	Name
210911	14177	Face Plate
202135	14176	" " Position Pin
200473B	14176	" " Thumb Screw
237707	14177	Feed Wheel
350085F	14179	" " Adjusting Screw
237708	14179	" " " " Block
237709	14180	" " Bracket
237710	14179	" " " Spring
237713	14179	" " Driving Gear with 200382c and 201220c (for 16 stitches)
201220c	14179	Feed Wheel Driving Gear Position Screw
200382c	14179	Feed Wheel Driving Gear Set Screw
237718	14179	" " " Pinion with 200382c and 201220c (for 16 stitches)
201220c	14179	Feed Wheel Driving Pinion Posi- tion Screw
200382c	14179	Feed Wheel Driving Pinion Set Screw
237721	14178	Feed Wheel Driving Shaft
237722	14179	" " " " Bushing (back)
237723	14179	Feed Wheel Driving Shaft Bushing (front)
200362c	14179	Feed Wheel Driving Shaft Bushing Set Screw
221743	14179	Feed Wheel Driving Shaft Collar with two 200380c
200380c	14179	Feed Wheel Driving Shaft Collar Set Screw
237724	14179	Feed Wheel Driving Shaft Gear with 200378c and 201220c
201220c	14179	Feed Wheel Driving Shaft Gear Po- sition Screw
200378c	14179	Feed Wheel Driving Shaft Gear Set Screw
237725	14179	Feed Wheel Stud
201697c	14179	" " " Nut
*203482	—	Hook (sewing)
237726	14181	" 203482 with 201253E, 201376E and 221148
237727	—	Hook and Bobbin Case complete, Nos. 200521 and 237726 <i>200521, 200594c</i>
235755	14181	Hook Bevel Gear Socket, 18 teeth
235527	14181	" " " " Bushing (lower) (brass)
200362c	14179	Hook Bevel Gear Socket Bushing (lower) Set Screw

No.	Plate	Name
235756	14181	Hook Bevel Gear Socket Bushing (upper) (brass)
449c	14181	Hook Bevel Gear Socket Bushing (upper) Set Screw
200555H	14181	Hook Bevel Gear Socket Screw ..
235635	14181	" " " " Thrust Washer
235529	14181	Hook Driving Bevel Gear with two 350089c
350089c	14181	Hook Driving Bevel Gear Set Screw
237728	14178	" " Shaft
235857	14181	" " Bevel Gear with 200374c and 200396c
237729	14180	Hook Driving Shaft Bevel Gear Housing with 200346c and three 200362c
237730	14180	Hook Driving Shaft Bevel Gear Housing Cap (bottom)
237731	14180	Hook Driving Shaft Bevel Gear Housing Cap (bottom) Gasket ..
237732	14180	Hook Driving Shaft Bevel Gear Housing Cap (side)
237733	14180	Hook Driving Shaft Bevel Gear Housing Cap (side) Gasket
200053c	14181	Hook Driving Shaft Bevel Gear Housing Cap Screw (4)
200485E	14181	Hook Driving Shaft Bevel Gear Housing Oil Stop Screw
201082E	14181	Hook Driving Shaft Bevel Gear Housing Screw (long)
201308E	14181	Hook Driving Shaft Bevel Gear Housing Screw (short)
200396c	11607	Hook Driving Shaft Bevel Gear Position Screw
200374c	14181	Hook Driving Shaft Bevel Gear Set Screw
237734	14181	Hook Driving Shaft Bushing (back)
200362c	14179	" " " " " " Set Screw
235531	14181	Hook Driving Shaft Bushing (front)
200347c	14181	" " " " " " Set Screw
221743	14179	Hook Driving Shaft Collar with two 200380c
200380c	14179	Hook Driving Shaft Collar Set Screw
221148	14181	Hook Gib
201376F	14181	" " Hinge Screw
201253F	14181	" " Screw

No.	Plate	Name
237735	14180	Hook Saddle with 449c, 200347c and three 200362c
235534	14182	Hook Saddle Oil Cover
201185D	14182	" " " " Screw (2) ..
201318E	14182	" " " " Stop Screw (2) ..
235535	-----	" " Oiling Felt
202260	-----	" " " Wick
235649	14182	" " " " Cover
200169H	14182	" " " " " Screw
201308E	14181	" " Screw (2)
213018	-----	" Washer
203507	14182	" " 213018 with 203476 and two 204243
202987	11616	Knee Lifter Connection Lever with 202446
200224H	14182	Knee Lifter Connection Lever Hinge Screw
202447	11616	Knee Lifter Connection Lever Lifting Rod with 202302
202302	14182	Knee Lifter Connection Lever Lifting Rod Cotter Pin
202446	14182	Knee Lifter Connection Lever Pin
202687	11616	" " Lifting Lever
200262H	14182	" " " " Hinge Screw
237736	14182	Needle Bar with 200141F
202552	11607	" " Connecting Link
202663	11607	" " " " Oil Guard
200161D	11607	Needle Bar Connecting Link Oil Guard Screw
202333	11607	Needle Bar Connecting Link Stud with 202254
202254	-----	Needle Bar Connecting Link Stud Oil Packing (wick)
200374c	14181	Needle Bar Connecting Link Stud Set Screw
200383c	14182	Needle Bar Connecting Link Stud Set Screw
*206891	-----	Needle Bar Connecting Stud
202329	11607	" " " " 206891 with 200086c and 202330
202330	-----	Needle Bar Connecting Stud Oil Packing (wick)
200086c	11607	Needle Bar Connecting Stud Pinch Screw
202692	14183	Needle Bar Crank with 200335c, 200374c, 200383c, 200428c and 202333

No.	Plate	Name
237737	—	Needle Bar Crank 202692 with 202329, 202398 to 202400 and 202552
203172	11607	Needle Bar Crank Friction Washer
200428c	11607	" " " Position Screw..
200335c	14176	" " " Set Screw
202664	14183	" " Rock Frame
237738	—	" " " " 202664 with 237736
*38127	—	Needle Bar Rock Frame Driving Eccentric
*237749	—	Needle Bar Rock Frame Driving Eccentric Body
350107c	—	Needle Bar Rock Frame Driving Eccentric Body Position Screw..
443c	14182	Needle Bar Rock Frame Driving Eccentric Body Set Screw
21331	14182	Needle Bar Rock Frame Driving Eccentric Pressure Spring
21332	14182	Needle Bar Rock Frame Driving Eccentric Pressure Spring Cap..
934b	14182	Needle Bar Rock Frame Driving Eccentric Pressure Spring Cap Screw
1103c	14182	Needle Bar Rock Frame Driving Eccentric Regulating Screw ...
196F	14182	Needle Bar Rock Frame Driving Eccentric Set Screw
227750	—	Needle Bar Rock Frame Driving Eccentric complete, Nos. 196F, 443c, 934b, 1103c, 21331, 21332, 38127, 237749 and 350107c
237739	14183	Needle Bar Rock Frame Driving Fork Lever with 200029c
200029c	14182	Needle Bar Rock Frame Driving Fork Lever Pinch Screw
237740	14182	Needle Bar Rock Frame Driving Fork Lever Slide Block (2)
210910	11607	Needle Bar Rock Frame Hinge Stud with 202277
202277	—	Needle Bar Rock Frame Hinge Stud Oil Packing (wick)
200347c	14181	Needle Bar Rock Frame Hinge Stud Set Screw
202666	11607	Needle Bar Rock Frame Position Bracket
200098F	11607	Needle Bar Rock Frame Position Bracket Screw
202667	11616	Needle Bar Rock Frame Rock Shaft

No.	Plate	Name
210978	—	Needle Bar Rock Frame Rock Shaft 202667 with 200386c and 210920
202668	11607	Needle Bar Rock Frame Slide Block
210920	—	Needle Bar Rock Frame Slide Block 202668 with 201141c
201141c	14182	Needle Bar Rock Frame Slide Block Screw Stud
200386c	11607	Needle Bar Rock Frame Slide Block Screw Stud Set Screw ..
200141F	11607	Needle Set Screw
207072	11607	Presser Bar Bushing (2)
200352c	14182	" " " Set Screw (2)
202671	14182	" " Lifter
200653c	14182	" " " Hinge Screw ..
202672	14184	" " Lifting Releasing Lever Bracket
200975F	14184	Presser Bar Lifting Releasing Lever Bracket Guide Screw
202342	14184	Presser Bar Lifting Releasing Lever Bracket Spring (spiral)
202337	14184	Presser Bar Position Guide
202338	14184	" " " " Lever with 200086c
200086c	11607	Presser Bar Position Guide Lever Pinch Screw
200352c	14182	Presser Bar Position Guide Set Screw
210948	11616	Presser Bar Spring (flat)
210949	14184	" " " Bracket with 200086c
200086c	11607	Presser Bar Spring Bracket Pinch Screw
200538c	14184	Presser Bar Spring Regulating Screw
200948F	14184	Presser Bar Spring Support Screw
201910	14184	Roller Presser, $\frac{3}{8}$ in. diam., $\frac{1}{4}$ in. face (coarse), with 200551F and 201534H
204328	14184	Roller Presser Arm
204570	—	" " " 204328 with 201910
202560	14184	Roller Presser Arm Bracket (swing)
204575	—	Roller Presser Arm Bracket 202560 with 200096D and 204570
200675c	14184	Roller Presser Arm Bracket Position Screw Stud

No.	Plate	Name
202558	14184	Roller Presser Arm Bracket Spring
202559	14184	" " " " "
		Stop
200141F	11607	Roller Presser Arm Bracket Spring Stop Screw
200096D	14184	Roller Presser Arm Screw
202557	14183	" " Bar
200551F	14184	" " Hinge Screw
201534H	14184	" " " " Nut
237753	—	Roller Presser and Bar complete, Nos. 200675c, 202557 to 202559, 204575 and two 200141F
202068	14183	Spool Holder Base
200575H	14184	" " " Screw
204296	14183	" " Wire
200079H	14184	" " " Hinge Screw ...
204297	14183	Spool Holder complete, Nos. 200079H, 202068 and 204296
202398	11609	Take-up Lever
202399	11609	" " Driving Stud with 202277
202277	—	Take-up Lever Driving Stud Oil Packing (wick)
202400	11609	Take-up Lever Hinge Stud with 202423
202423	—	Take-up Lever Hinge Stud Oil Packing (wick)
200363C	14184	Take up Lever Hinge Stud Set Screw
202401	—	Take up Lever Oiling Felt
200132E	11609	" " " " Screw...
202402	11610	Tension Disc (back)
210967	11610	" " (front)
210950	11609	" Release Driving Lever with 200394c and 202676
202676	11609	Tension Release Driving Lever Pin
202677	11609	" " " " "
		Slide Bar
210966	—	Tension Release Driving Lever Pin Slide Bar 202677 with 200167F and 210952
202678	11609	Tension Release Driving Lever Pin Slide Bar Spring
200394C	11609	Tension Release Driving Lever Set Screw
210951	11610	Tension Release Washer
202407	10881	" Spring
200625F	11610	" Stud with 204925
200084F	14184	" " Set Screw

No.	Plate	Name
204925	11610	Tension Stud Washer
201572B	10881	" Thumb Nut
210953	11610	Tension complete, Nos. 200625F, 201572B, 202402, 202407, 202682, 210951 and 210967
202682	11610	Thread Controller Spring
210952	11610	" " " Stop
200167E	11610	" " " " Screw
210954	11610	" Guide (lower)
210955	11610	" " (upper)
200582H	11610	" " Screw (3)
210956	11610	" Retainer Bracket with 200397H
200582H	11610	Thread Retainer Bracket Screw (2)
210960	11610	" " Disc
210961	11610	" " Plunger
210962	11610	" " " Spring
210993	11610	" " Sleeve
210963	11610	" " Socket
200368H	14184	" " " Set Screw ..
223844	14184	" " Spring
210957	11610	" " Stud
210958	11610	" " " Collar
200397D	11610	" " " Set Screw
210959	11610	Thread Retainer (lower) complete, Nos. 210956 to 210958, 210993 and 223844
237741	14184	Throat Plate, 53 elongated needle hole, for needle sizes 14 and 15
200161D	11607	Throat Plate Clamp Screw
202062	14184	" " Position Pin
	691F	14184 " " Screw
237744	14183	Vertical Shaft
237745	14185	" " Bevel Gear (lower)
205508	14185	" " " " "
		Position Pin
235857	14181	Vertical Shaft Bevel Gear (upper) with 200374c and 200396c
200396C	11607	Vertical Shaft Bevel Gear (upper) Position Screw
200374C	14181	Vertical Shaft Bevel Gear (upper) Set Screw
237734	14181	Vertical Shaft Bushing (lower) ...
200346C	14185	" " " " " Set Screw
237746	14185	Vertical Shaft Bushing (upper) ..
200382C	14179	" " " " " Set Screw

No.	Plate	Name
237747	14185	Vertical Shaft Driving Gear with 200374c and 200396c
200396c	11607	Vertical Shaft Driving Gear Position Screw
200374c	14181	Vertical Shaft Driving Gear Set Screw
237754	---	Vertical Shaft Oil Leader (lower) (brass)
237755	---	Vertical Shaft Oil Leader (upper) (brass)

ACCESSORIES

No.	Plate	Name
200157B	14185	Attachment Screw
203470	14176	Bobbin (5)
*225482	---	" Case Screw Driver Blade ..
*225483	---	" " " " Handle ..
225497	12345	Bobbin Case Screw Driver complete, Nos. 225482 and 225483 ..
237714	---	Feed Wheel Driving Gear with 200382c and 201220c (for 17½ stitches)
237715	---	Feed Wheel Driving Gear with 200382c and 201220c (for 19 stitches)
237719	---	Feed Wheel Driving Pinion with 200382c and 201220c (for 17½ stitches)
237720	---	Feed Wheel Driving Pinion with 200382c and 201220c (for 19 stitches)
225487	14185	Roller Presser Hinge Screw Nut
16 x 4	---	Wrench
237756	---	Needles, six, two each, sizes 12, 14 and 16
41400	12345	Drip Pan with four wood screws ½ in., No. 5
36578	12345	Machine Rest Pin (wood)
36579	12345	Oiler with 36579
120117	---	" Spout, 3½ in. long, with 120117
*225484	---	" " Washer (leather)
*225485	---	" " Screw Driver Blade
225498	12345	" " Handle
225554	12345	Screw Driver complete (7½ in. long), Nos. 225484 and 225485 ..
		Wrench (steel)

BOBBIN WINDER

Swing Automatic, Right Hand

*225.51	---	Bobbin Holder
225453	10882	Frame with 202277 and 225438 ..
225454	10882	" Hinge Pin
202277	---	" Oil Packing (wick)
225438	10882	" " Well Cap
225455	10882	" Spring
225456	10882	" " Plunger

No.	Plate	Name
202473	10883	Pulley with 200105c
200105c	14185	" Set Screw
*225443	-----	Spindle
225452	10882	" 225443 with 225451
225444	10882	Stop Latch
200056E	10882	" " Screw
225458	10882	" " Thumb Lever
225459	10882	" " " " Hinge Stud
225460	10882	" " " " Joint Stud
202478	10882	" " Trip Lever
200299H	10882	" " " " Hinge Screw
225461	10881	Tension Bracket with 201499B
200082D	10881	" " Screw
228026	14185	" " " Washer
2102	10881	" Disc
202407	10881	" Spring
201499B	10881	" Stud
201572B	10881	" " Thumb Nut
225462	10881	Bobbin Winder Tension Bracket complete, Nos. 201572B, 202407, 225461 and two 2102
225433	10883	Bobbin Winder and Tension Bracket Base
225436	10883	Universal Bobbin Winder complete, Nos. 200056E, 200082D, 200299H, 202473, 202478, 225433, 225444, 225452 to 225456, 225458 to 225460, 225462, 228026 and two wood screws $\frac{3}{4}$ in., No. 13, R.H.B. ...

KNEE LIFTER

227781	11616	Knee Lifter Rock Lever with 200522c and 200529c
227782	-----	Knee Lifter Rock Lever 227781 with two each 202451 and 202452
227787	-----	Knee Lifter Rock Lever 227782 with 202203 and 227784
202453	11616	Knee Lifter Rock Lever Knee Plate with 200526c
202203	-----	Knee Lifter Rock Lever Knee Plate 202453 with 202454
202454	11616	Knee Lifter Rock Lever Knee Plate Arm
200522c	14185	Knee Lifter Rock Lever Knee Plate Arm Set Screw
200526c	14185	Knee Lifter Rock Lever Knee Plate Set Screw

No.	Plate	Name
202451	11616	Knee Lifter Rock Lever Lug with two wood screws $\frac{3}{4}$ in., No. 13...
202452	14185	Knee Lifter Rock Lever Lug Hinge Pin
227784	11616	Knee Lifter Rock Lever Rod, 3 in. long, with 227785
*227785	-----	Knee Lifter Rock Lever Rod Cap or Oil Guard
200529c	14185	Knee Lifter Rock Lever Rod Set Screw

(Other Knee Lifter parts are listed with
parts of machine head.)

FEED GEARS

No.	Plate	Name
237711	—	Feed Wheel Driving Gear with 200382c and 201220c (for 14 stitches)
237712	—	Feed Wheel Driving Gear with 200382c and 201220c (for 15 stitches)
237713	14179	Feed Wheel Driving Gear with 200382c and 201220c (for 16 stitches)
237714	—	Feed Wheel Driving Gear with 200382c and 201220c (for 17½ stitches)
237715	—	Feed Wheel Driving Gear with 200382c and 201220c (for 19 stitches)
237751	—	Feed Wheel Driving Gear with 200382c and 201220c (for 23 stitches)
237716	—	Feed Wheel Driving Pinion with 200382c and 201220c (for 14 stitches)
237717	—	Feed Wheel Driving Pinion with 200382c and 201220c (for 15 stitches)
237718	14179	Feed Wheel Driving Pinion with 200382c and 201220c (for 16 stitches)
237719	—	Feed Wheel Driving Pinion with 200382c and 201220c (for 17½ stitches)
237720	—	Feed Wheel Driving Pinion with 200382c and 201220c (for 19 stitches)
237752	—	Feed Wheel Driving Pinion with 200382c and 201220c (for 23 stitches)

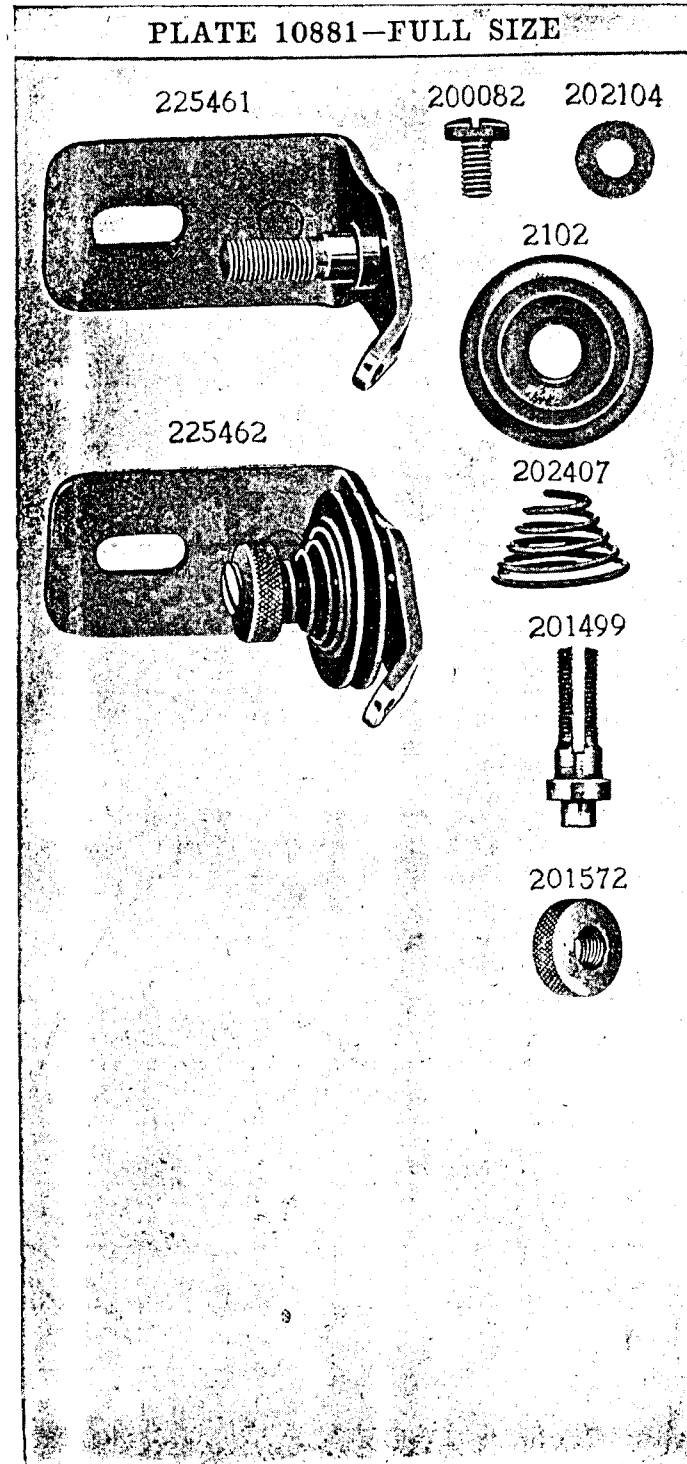

PLATE 10882—FULL SIZE

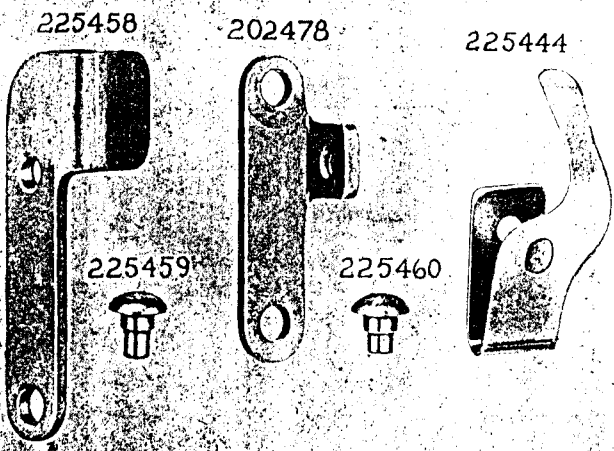
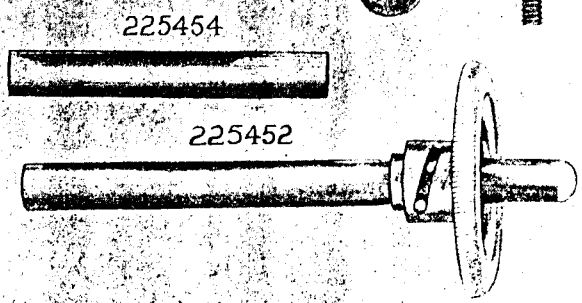
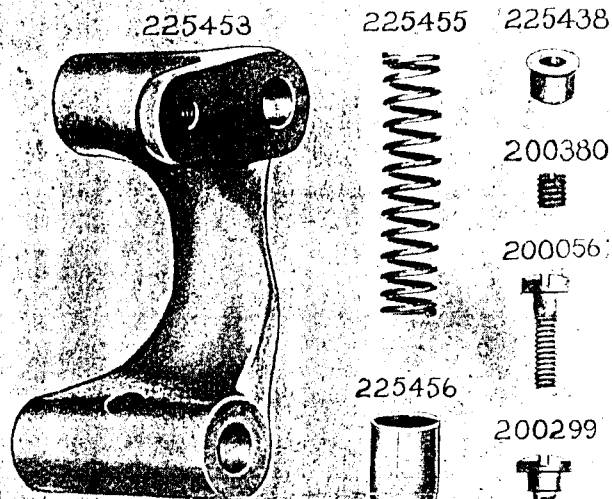

PLATE 10883 ONE-FOURTH SIZE

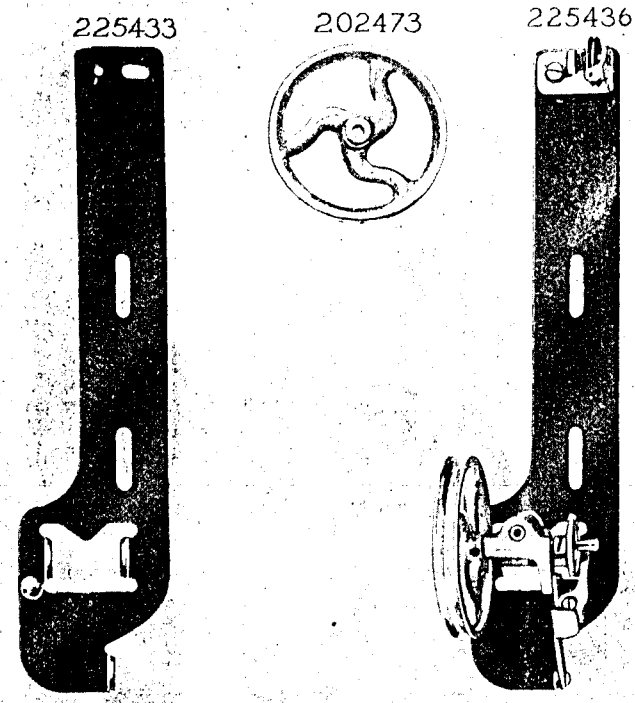

PLATE 11607 - FULL SIZE

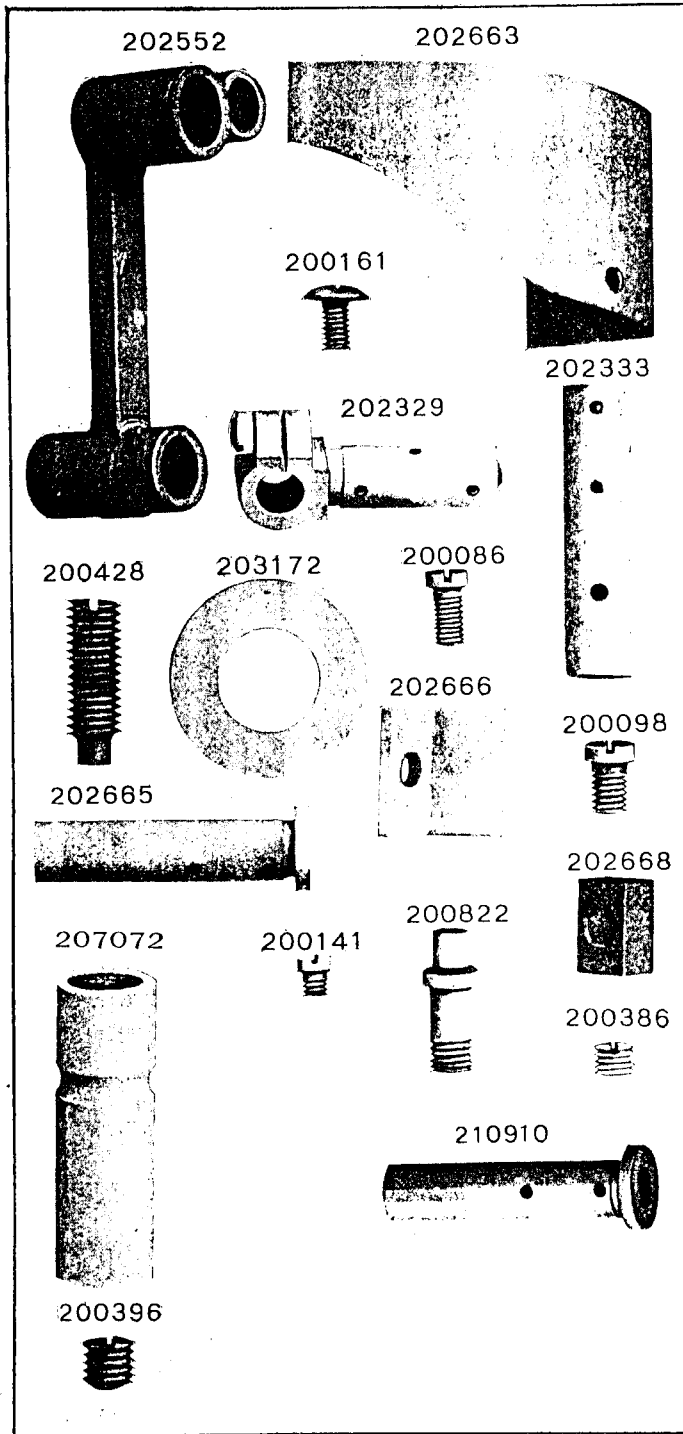

PLATE 11609 - FULL SIZE

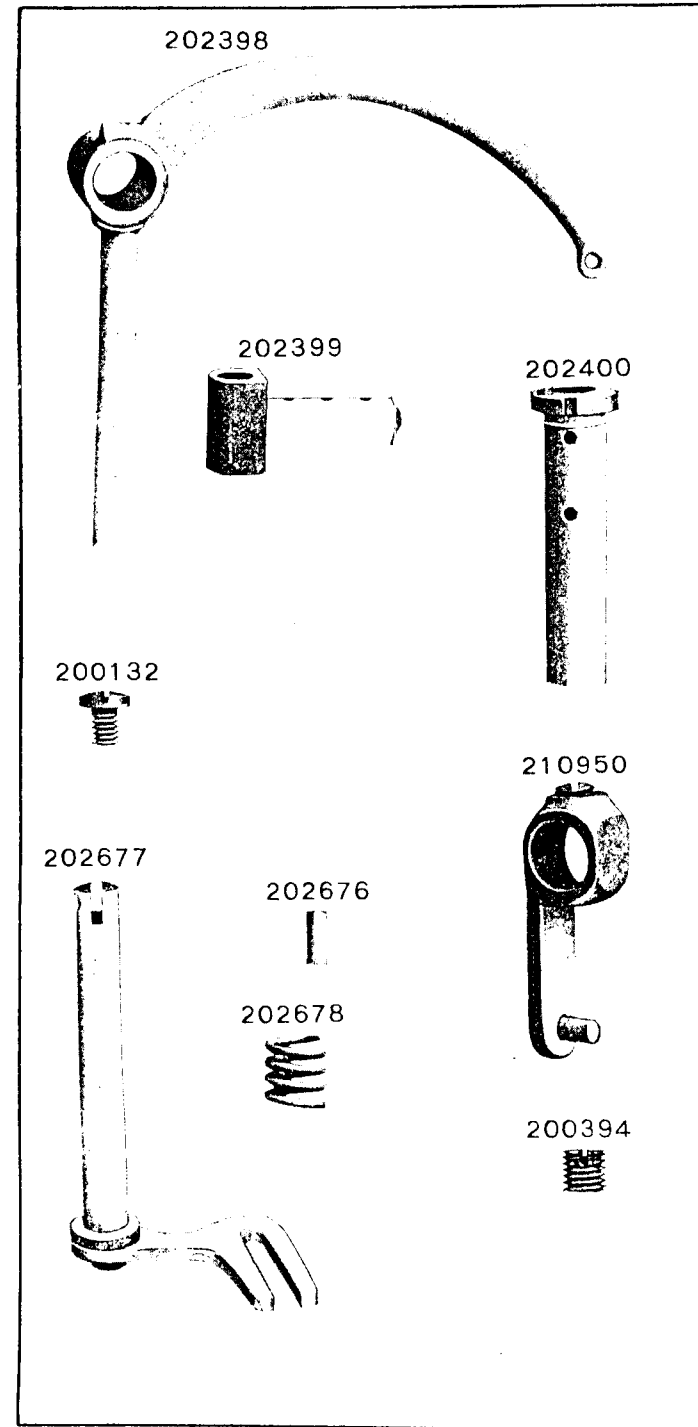

PLATE 11610 - FULL SIZE

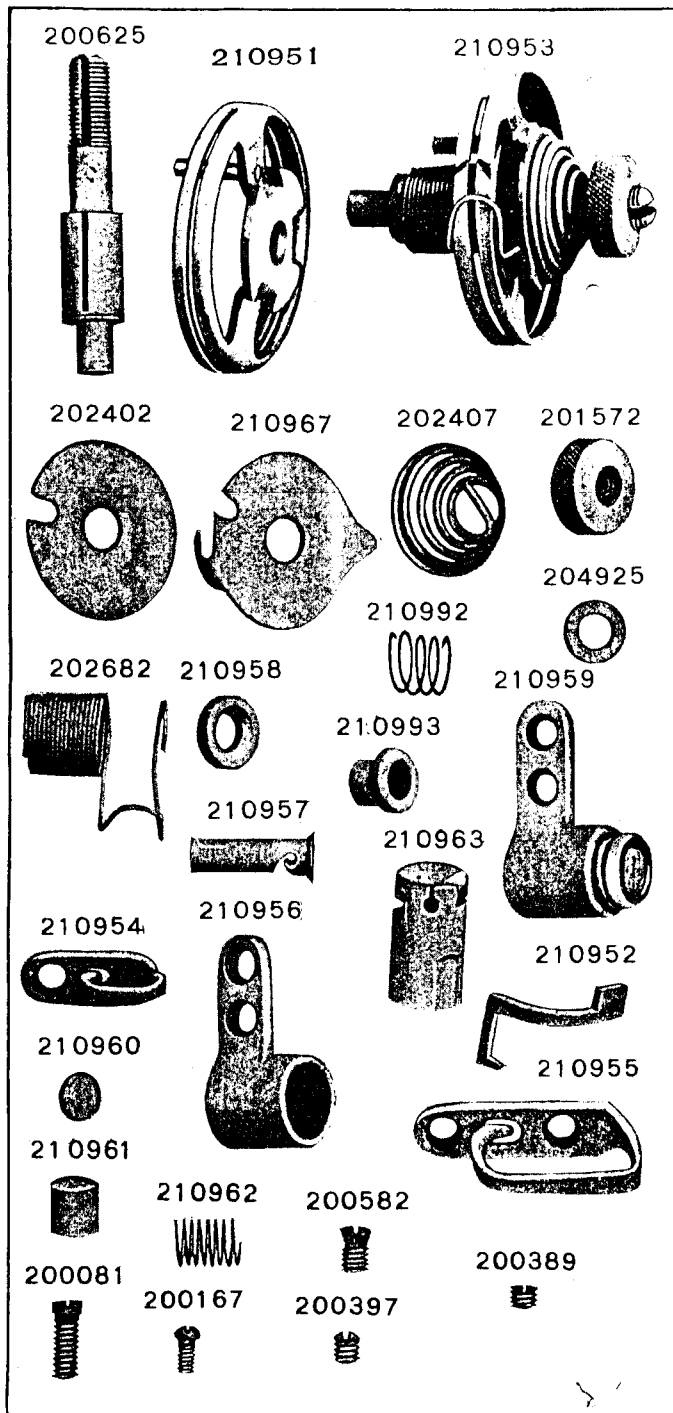

PLATE 11616 - ONE-FOURTH SIZE

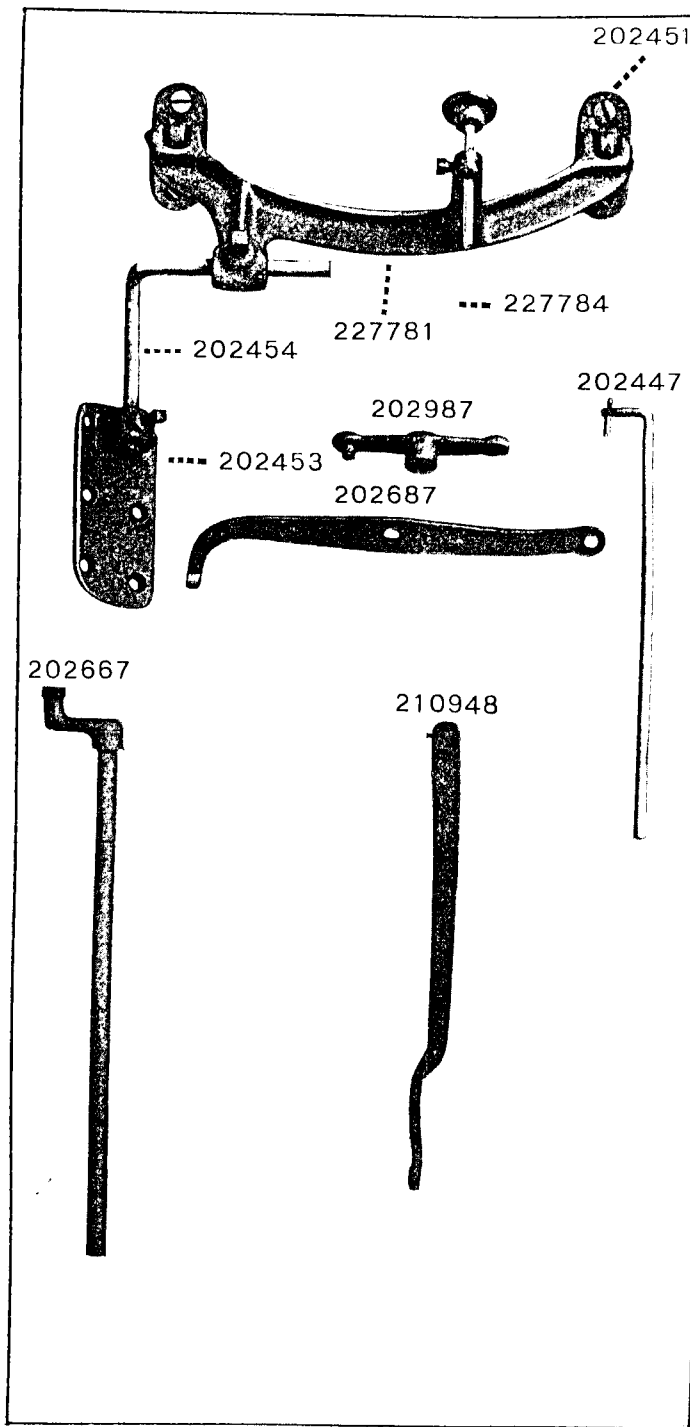

PLATE 12345—ONE-HALF SIZE

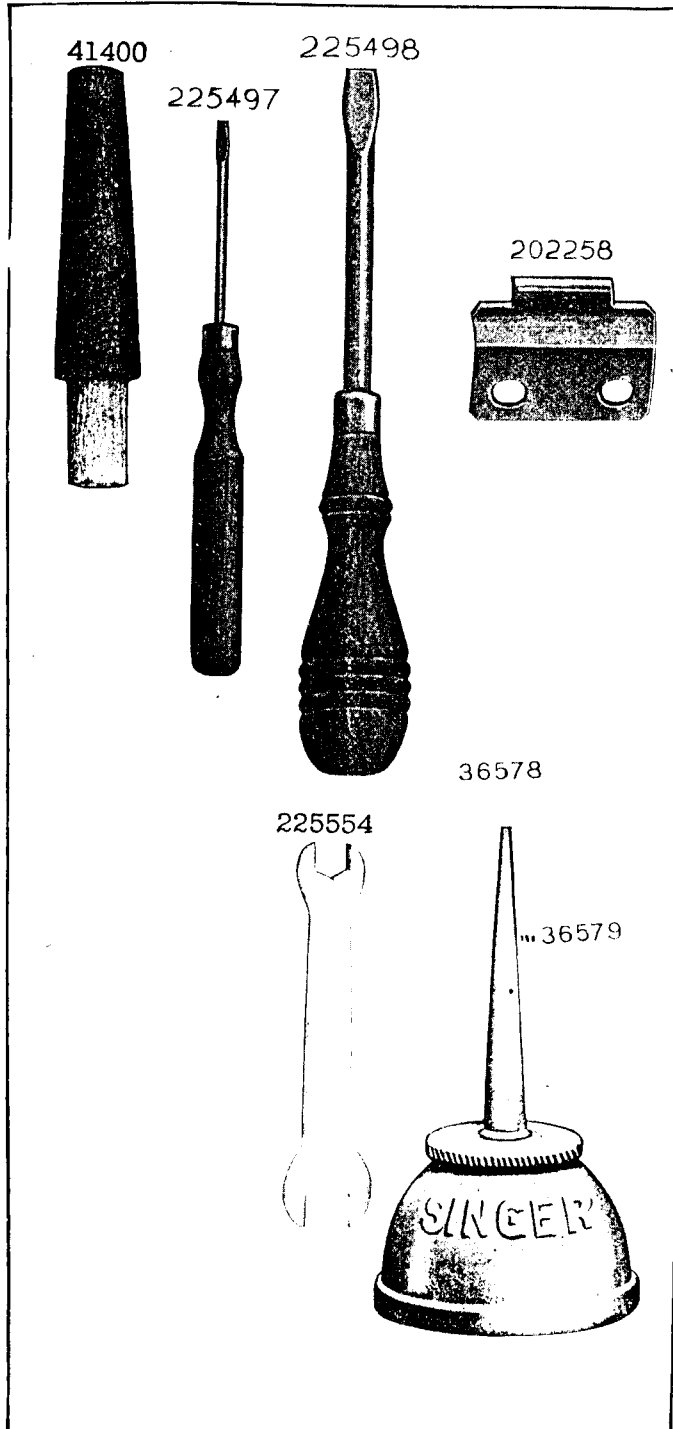

PLATE 14176—FULL SIZE

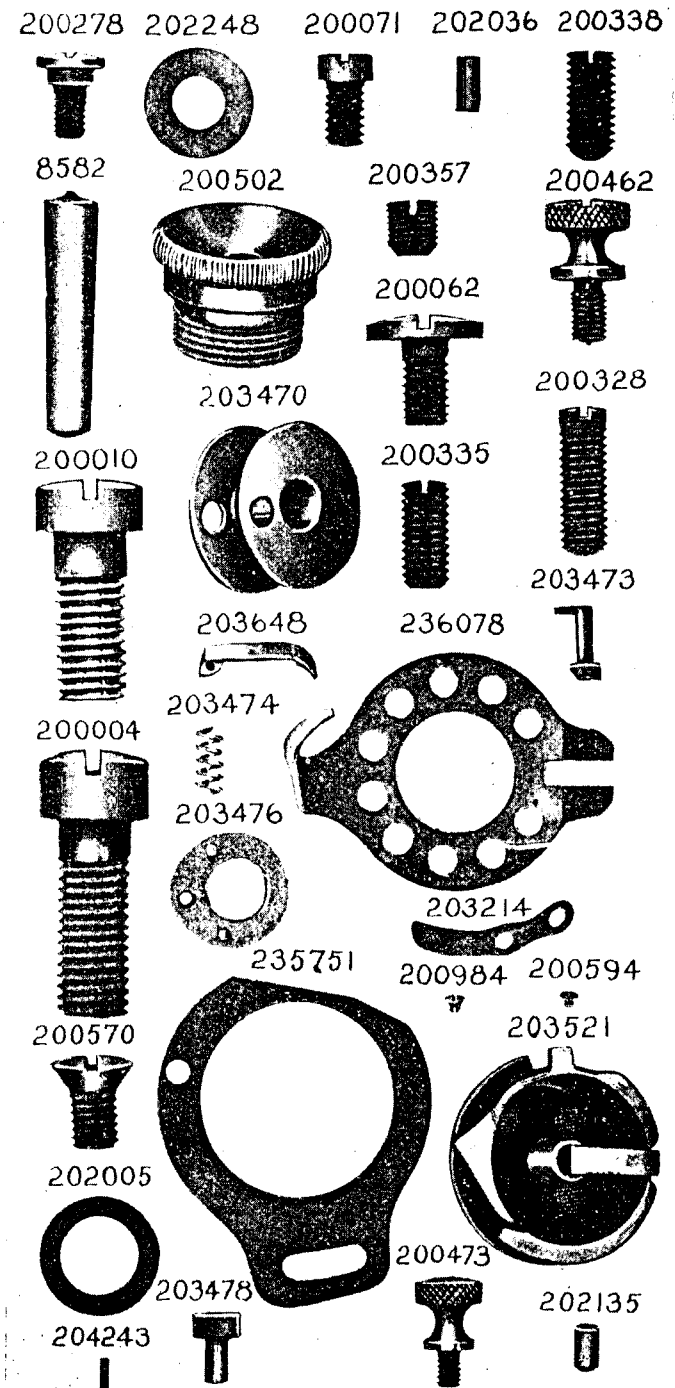

PLATE 14177—ONE-HALF SIZE

202247



237706



237748

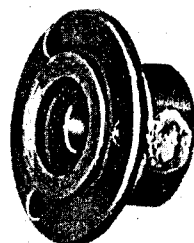

213750

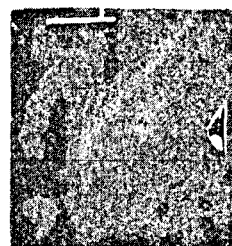

202245



210911



202632

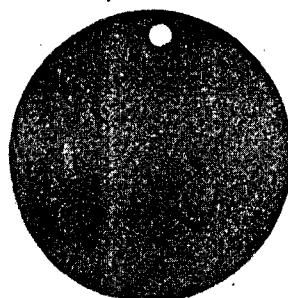

237707

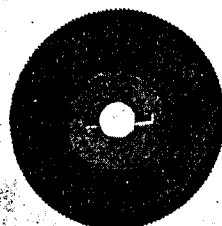

PLATE 14178—ONE-FOURTH SIZE

237721 237702 237728 223842

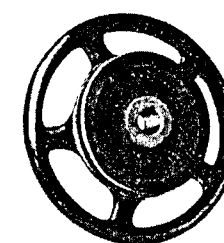
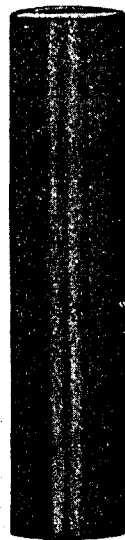

PLATE 14179—FULL SIZE

237723



237722



237724

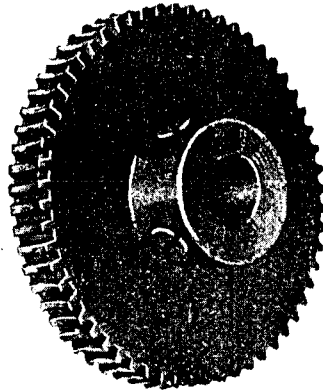

237713

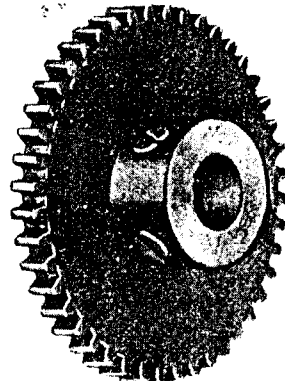

237718

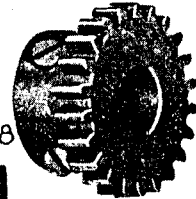

237708



201697



237710



350085



200378



200382



201220



200362



200380



221743



237725

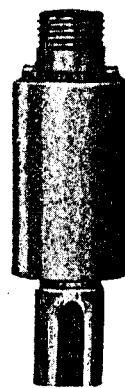
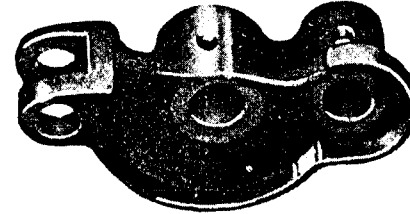
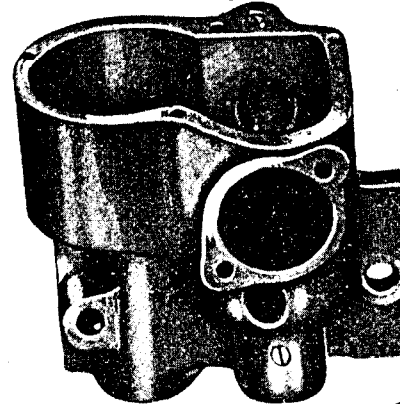

PLATE 14180—ONE-HALF SIZE

237709



237729



237733

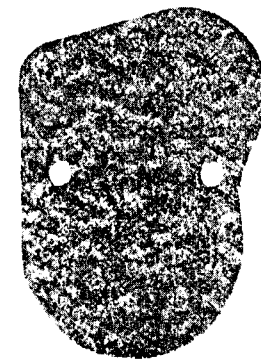

237732

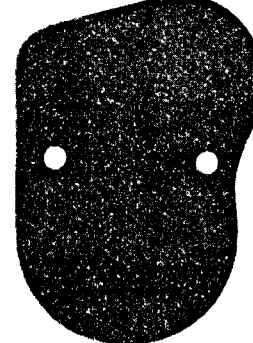

237735

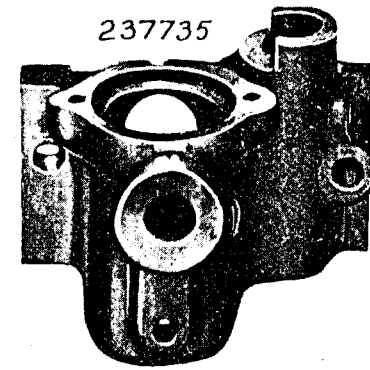

237730



237731



PLATE 14181—FULL SIZE

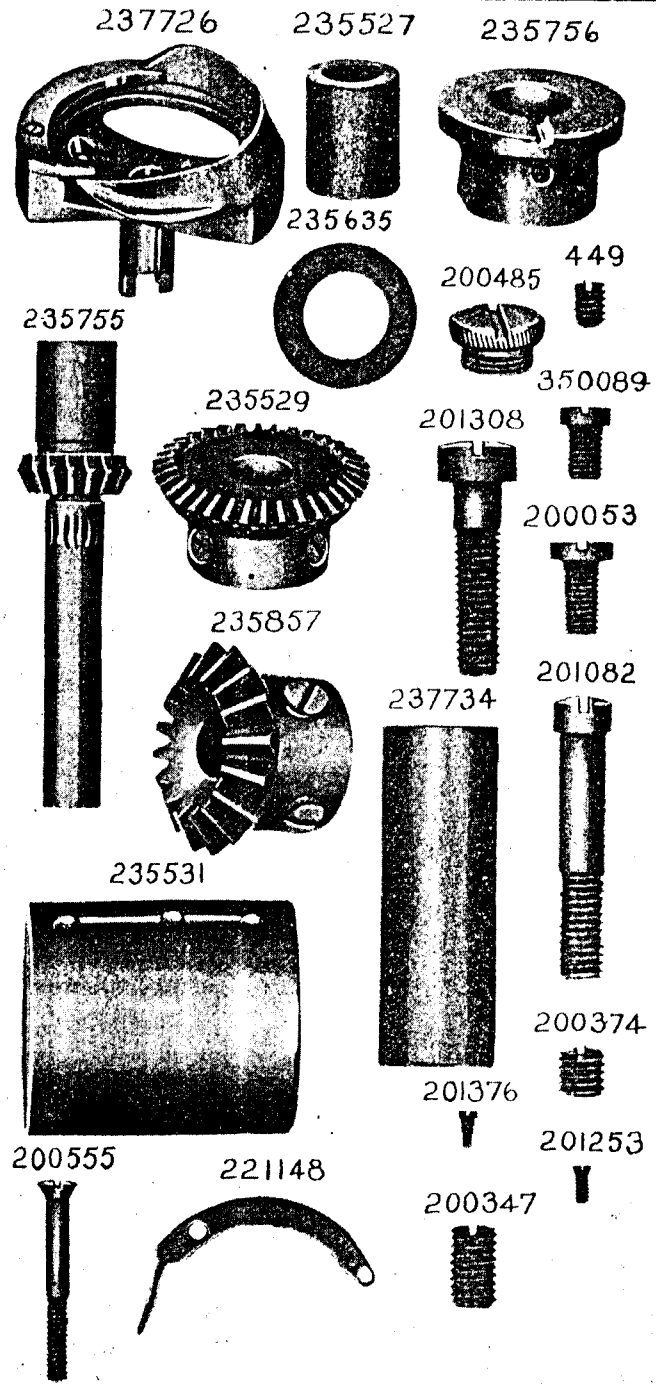

PLATE 14182—FULL SIZE

737937

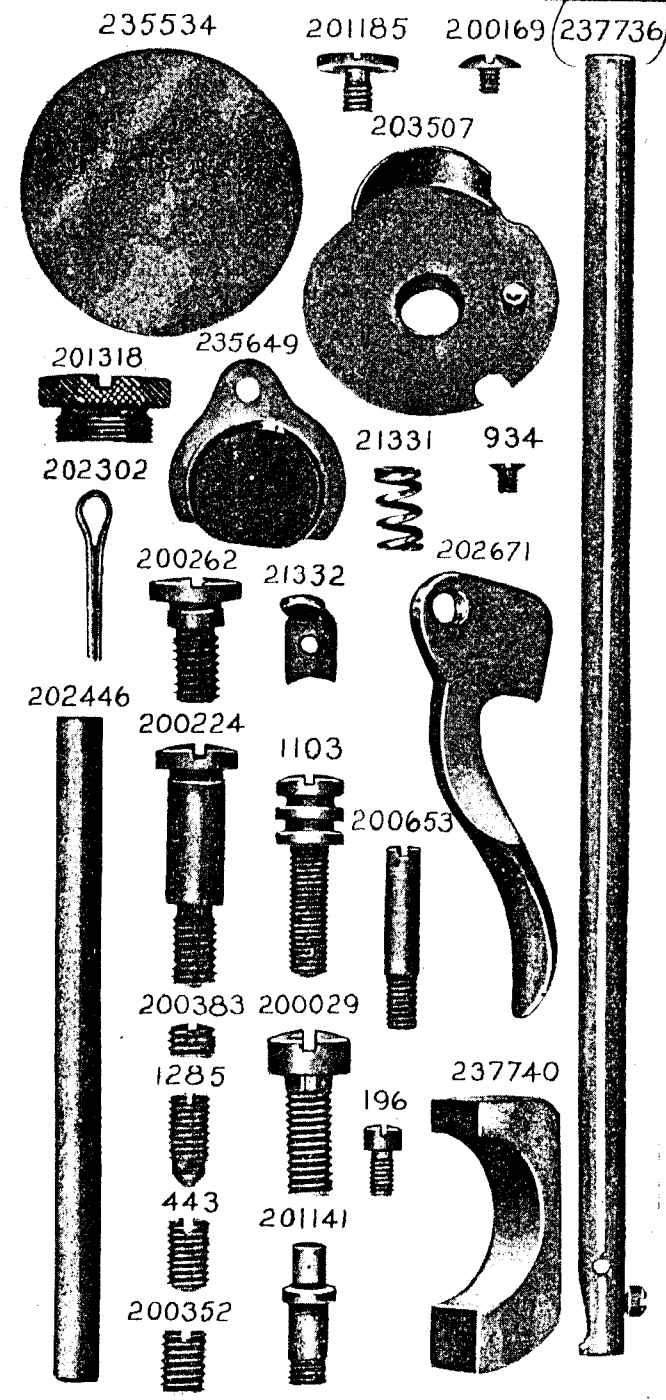

PLATE 14183—ONE-HALF SIZE

202692 202664 237744 202557

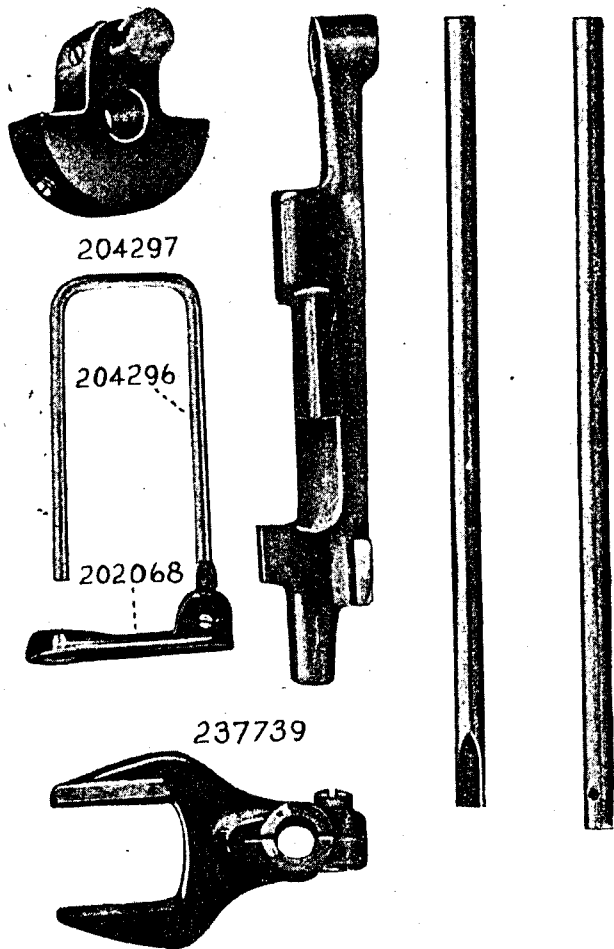

PLATE 14184—FULL SIZE

202337 210949 200975 202672

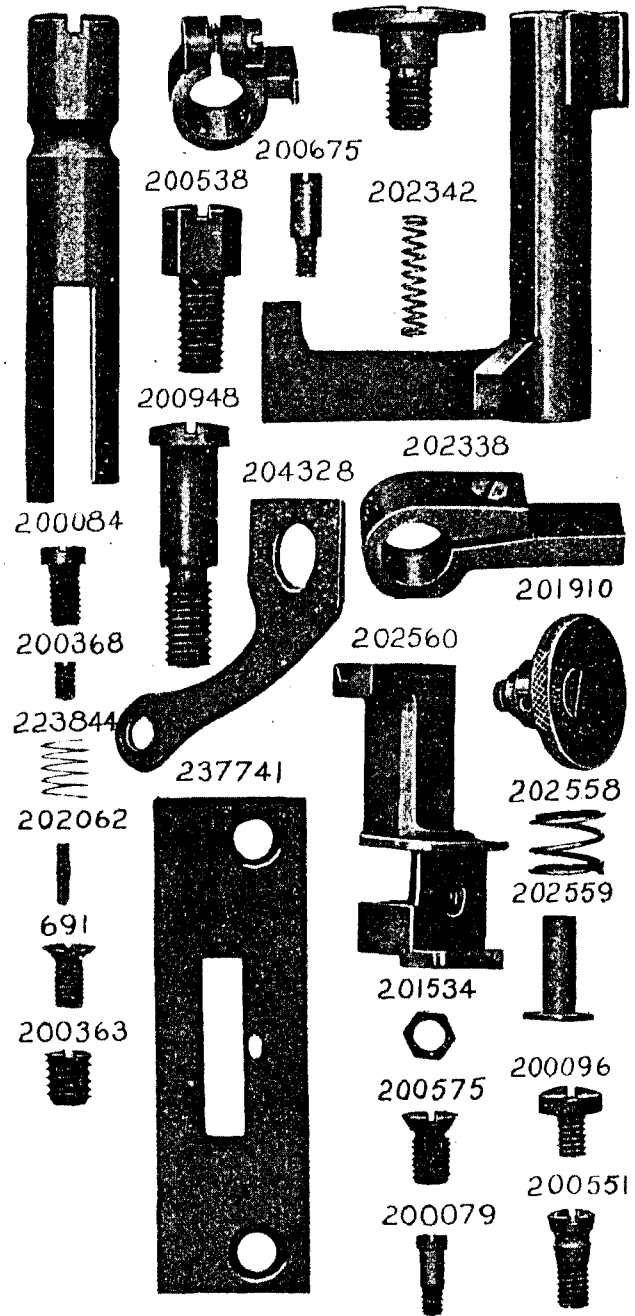
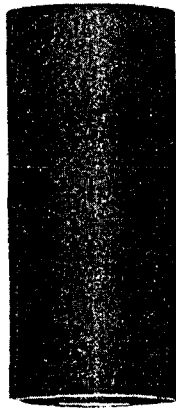
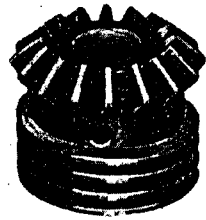

PLATE 14185-FULL SIZE

237745 205508 200346 237746



237747

225487

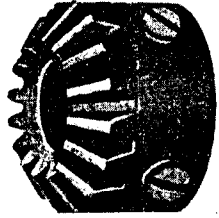

200105



228026



200157



200522



200526



200529



202452

