

FORM 18954
(1235)
PRINTED IN U. S. A.

LIST OF PARTS



SINGER** MACHINES

Nos. 81-53 and 81-56

THE SINGER MANUFACTURING COMPANY

**A Trade Mark of THE SINGER MANUFACTURING COMPANY

INSTRUCTIONS FOR OILING

To ensure easy running and prevent unnecessary wear of the parts which are in movable contact, the machine requires oiling and when in continuous use, "TYPE B" or "TYPE D" OIL, sold by Singer Sewing Machine Company, should be applied at least twice each day to all oil holes marked "OIL", as instructed in Form 18594.

"TYPE D" OIL should be used when an oil is desired which will produce a minimum of stain on fabrics, even after a long period of storage.

Fill reservoir in base to "high" mark, and inspect often enough to keep oil level from going below "low" mark in base.

Copyright, U. S. A. 1932, 1933 and 1935
by the Singer Manufacturing Co.
All Rights Reserved for all Countries

INDEX

	Page
Accessories.....	22
Bench Stands.....	22
Fittings Chart for No. 81-53 Machine.....	15
Fittings for No. 81-53 Machine.....	16
Fittings for No. 81-56 Machine.....	21
Foot Lifter Parts.....	23
Knee Lifter Parts.....	24
Knife Grinders.....	25
Machine Bases.....	26
Machine Base Oil Drain Jars.....	27
Machine No. 81-53.....	5
Machine No. 81-56.....	19
Numerical List of Parts.....	31
Obsolete Parts.....	29
Thread Unwinder.....	28

INSTRUCTIONS FOR ORDERING

In ordering from this list, use ONLY the part NUMBER in the FIRST column.

The number stamped on a Sewing Machine Part is in every case the number of the single part only.

Every combination of parts sent out as such has its specific number, which, although not stamped on the parts, must be used when ordering the combination.

Each number always indicates the SAME PART in whatever list it appears, or for whatever machine.

The letters after some of the numbers indicate the style of finish only, as follows:

A-Hardened, Polished, Nickel Plated and Buffed

B-Polished, Nickel Plated and Buffed

C-Hardened Only

D-Polished Only

E-Soft, Not Polished

F-Hardened and Polished

G-Bright Rumbled and Nickel Plated

H-Blued

J-Nickel Plated Only

K-Hardened and Nickel Plated

L-Brass Plated

M-Oxidized

N-Japanned, Dull

P-Japanned, Bright

R-Merlized

T-Copper Plated

T.A-Hardened, Polished, Copper and Nickel Plated and Buffed

T.B-Copper and Nickel Plated and Polished

T.J-Copper and Nickel Plated Only

T.K-Hardened, Copper and Nickel Plated

T.M-Copper Plated and Oxidized

T.L-Copper and Brass Plated

U-Zinc Plated

V-Silver Plated

W-Polished and Nickel Plated

Y-Black Nickel Plated Only

Z-Chromium Plated

Z.B-Polished, Nickel Plated, Buffed and Chromium Plated

Z.J-Nickel and Chromium Plated

These letters MUST BE USED when they appear in the list; and AFTER the number as in the list.

In this series:

1 to 1500, 50001 to 51500 and 140001 to 142000 are Screw Numbers

1501 to 1800 and 51501 to 51800 are Nut Numbers

1801 to 2000 and 51801 to 52000 are Roller Numbers

2001 to 50000 and 52001 to 140000 and 142001 to

190000 are Sewing Machine Parts, 190001 and upward

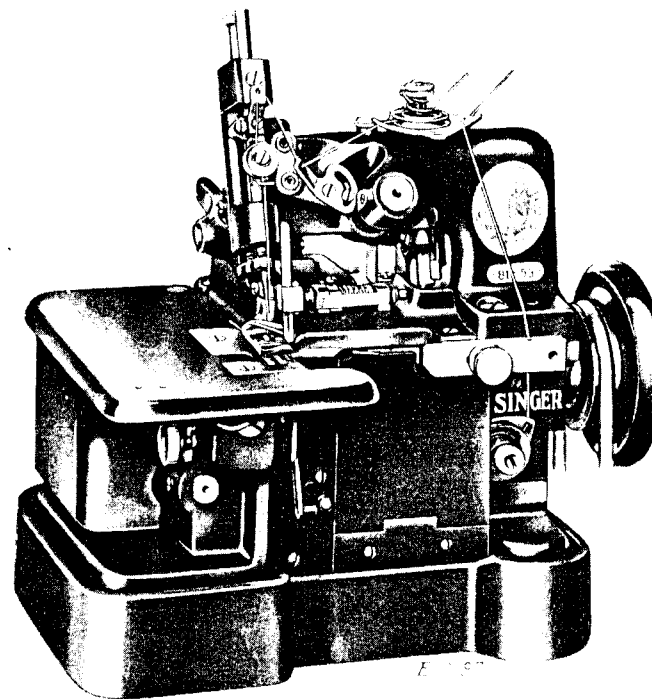
are numbers of Electrical Parts.

The figures in the second column refer only to the plates, illustrating the parts, and are NOT TO BE USED in ordering.

Parts marked with an asterisk (*) are furnished only when repairs are made at factory.

LIST OF PARTS COMPLETE

FOR



MACHINE No. 81-53

For Trimming, Overedging and Closing Seams in Light and Medium Weight Knit Material and Rayon. Three-thread stitch. Foot Lifter. Gathering feed. The front and rear feed dogs rise and fall simultaneously and can be adjusted to regulate the fullness of the gathering in sweater material or for Rayon material where gathering is not required. Speed up to 5000 R. P. M. on short runs, depending on the material being stitched.

No.	Plate	Name
*132522	-----	Arm with 15404, 42253, 132580 and two each 462C, 624C, 15405 and 132589....
4389	20821	Arm Dowel Pin.....
68350	20821	" Oil Cup.....
949E	20806	" Screw.....
132632	20827	Balance Wheel, 1 7/8 in. pulley, with 446C and 1285C.....
1285C	20807	Balance Wheel Position Screw.....
446C	7409	" " Set Screw.....

No.	Plate	Name
132654	20827	Chip Guard.....
132524	20808	Cloth Plate with 132525.....
132801	20808	" " Extension (lower).....
233E	20809	" " " " Screw....
42108	20821	" " " (upper).....
233E	20809	" " " " Screw....
*132525	-----	" " Hinge Bracket.....
132526	20821	" " " Stud.....
50150C	20821	" " " " Set Screw.....
42005	20821	" " Lock Spring.....
236C	20821	" " " " Screw.....
132527	-----	Cloth Plate complete, Nos. 42005, 42108, 132524, 132801, two 236C and five 233E.....
132665	20819	Feed (back) Bar.....
1132C	20819	" " " Hinge Screw.....
132666	20819	" " " Pin (hollow).....
132667	20819	" " Connecting Link.....
132668	20809	" " Dog, 10 teeth (16 teeth to the inch).....
Note: No. 132668 is sent with this Machine, unless otherwise specified on order.		
203E	20824	Feed (back) Dog Screw.....
132670	20819	" " Regulator.....
51360W	20819	" " " Position Screw....
132671	20819	" (front) Bar with 1253C.....
*132672	-----	" " " 132671 with 1132C, 51360W 132528, 132539, 132665 to 132667, 132670 and 132676 (For factory use only).....
132528	7406	Feed (front) Bar Hinge Pin.....
1253C	7406	" " " " " Set Screw....
132529	7407	" " Connecting Rod with 171C, 1695J and two 1057E.....
132643	-----	Feed (front) Connecting Rod 132529 with 132644.....
1057E	20804	Feed (front) Connecting Rod Cap Screw...
51292C	7407	" " " " Hinge Screw.
171C	7413	" " " " " " "
		Clamping Screw.....
1695J	7407	Feed (front) Connecting Rod Hinge Screw Clamping Screw Nut.....
1520J	5569	Feed (front) Connecting Rod Hinge Screw Nut.....
132673	20809	Feed (front) Dog, 11 teeth (16 teeth to the inch).....
Note: No. 132673 is sent with this Machine, unless otherwise specified on order.		

No.	Plate	Name
190E	7406	Feed (front) Dog Screw.....
*132531	-----	" " Eccentric.....
*132532	-----	" " " " Body.....
1036C	5569	" " " " Set Screw...
19047	7407	" " " " Clamping Washer..
201J	7407	" " " " " "
		Screw.....
132533	7407	Feed (front) Eccentric Oil Tube.....
132644	20822	Feed (front) Eccentric (adjustable) com- plete, Nos. 201J, 19047, 51145C, 132531 to 132533 and two 1036C....
132651	7407	Feed (front) Eccentric Cover.....
50253J	7407	" " " " Screw.....
132712	20822	" " " " Lint Cover (spring).....
132785	20803	Feed (front) Eccentric Lubricator with 132537.....
132537	20803	Feed (front) Eccentric Lubricator Oil Wick (braided cotton).....
132649	20803	Feed (front) Lifting Eccentric with two 462C.....
132539	20803	Feed (front) Lifting Eccentric Connec- tion.....
462C	20803	Feed (front) Lifting Eccentric Set Screw
51145C	7407	" " Regulating Screw.....
132675	20819	" " Rock Shaft.....
132676	-----	Feed (front) Rock Shaft complete, Nos. 42021 and 132675.....
42021	20803	Feed (front) Rock Shaft Crank with 157E.
157E	20803	" " " " " Clamping Screw.....
132542	20803	Feed (front) Rock Shaft Hinge Pin with 132544.....
132543	20803	Feed (front) Rock Shaft Hinge Pin Bush- ing.....
132816	20823	Feed (front) Rock Shaft Hinge Pin Bush- ing Oil Wick (wick).....
1036C	20803	Feed (front) Rock Shaft Hinge Pin Bush- ing Set Screw.....
132544	20803	Feed (front) Rock Shaft Hinge Pin Oil Wick (braided cotton).....
*132545	-----	Frame.....
132546	20808	" Bottom Cover with 132594.....
132547	20808	" " " Gasket.....
190E	7406	" " " Screw.....
132548	20821	" Oil Cup.....
132549	20827	" Rotary Shaft with 132558 and 132559.....

No.	Plate	Name
132616	-----	Frame Rotary Shaft 132549 with 132585 and 132695.....
•132862	-----	Frame Rotary Shaft Bushing (front).....
132863	20817	" " " " 132862 with 132835, 132864 and two 132715..
132864	20823	Frame Rotary Shaft Bushing (front) Oil Pad (braided cotton).....
132715	20817	Frame Rotary Shaft Bushing (front) Oil Pad Retainer.....
132817	20823	Frame Rotary Shaft Bushing (front) Oil Wick (wick).....
51332C	20821	Frame Rotary Shaft Bushing (front) Set Screw.....
132769	20817	Frame Rotary Shaft Crank with 1036C, 1375C and 132773.....
132770	20817	Frame Rotary Shaft Crank Ball Sleeve....
132771	20817	" " " " " Bushing.....
1664E	20817	Frame Rotary Shaft Crank Ball Sleeve Bushing Nut.....
132772	20817	Frame Rotary Shaft Crank Ball Sleeve Bushing Nut Washer.....
132773	-----	Frame Rotary Shaft Crank Ball Sleeve Bushing Position Pin.....
132774	20817	Frame Rotary Shaft Crank Ball Sleeve Guide.....
1375C	20817	Frame Rotary Shaft Crank Position Screw.
1036C	20817	" " " " Set Screw.....
132775	-----	Frame Rotary Shaft Crank complete, Nos. 1664E and 132769 to 132772.....
132835	20817	Frame Rotary Shaft Crank Oil Sling Cover
•132865	-----	" " " Flanged Bushing (back).....
132866	20827	Frame Rotary Shaft Flanged Bushing (back) 132865 with 132692, 132867, 132868 and two 132803.....
132867	20823	Frame Rotary Shaft Flanged Bushing (back) Oil Pad (large) braided cotton.....
132868	20823	Frame Rotary Shaft Flanged Bushing (back) Oil Pad (small) braided cotton.....
132603	20827	Frame Rotary Shaft Flanged Bushing (back) Oil Pad Retainer.....
132817	20823	Frame Rotary Shaft Flanged Bushing (back) Oil Wick (wick).....
51332C	20821	Frame Rotary Shaft Flanged Bushing (back) Set Screw.....

No.	Plate	Name
132558	20823	Frame Rotary Shaft Oil Pad (braided cotton).....
132559	20823	Frame Rotary Shaft Oil Pad Retainer.....
•132692	20827	" " " " Sling Cover.....
132560	20827	" Side Cover (left) with 132701.....
132701	20821	" " " " Handle.....
330W	20821	" " " " Screw.....
42028	20827	" " " (right) Hinged.....
42101	20821	" " " " Lock Spring....
330W	20821	" " " " Screw.....
132780	20808	" Top Cover.....
132781	-----	" " " 132780 with 132782 to 132784 and two 197J.....
132650	7409	Frame Top Cover Extension.....
42102	7409	" " " " Holder.....
132600	-----	" " " " " 42102 with 42101, 132650, 132651 and two each 176J and 50253J.....
283W	7409	Frame Top Cover Extension Holder Thumb Screw.....
19044	7409	Frame Top Cover Extension Holder Thumb Screw Washer.....
176J	20806	Frame Top Cover Extension Screw.....
132782	20821	" " " " Oil Reservoir Cover....
197J	7414	" " " " " Screw
132783	20821	" " " " Tube.....
132784	20821	" " " " Wick.....
583F	20806	" " " " Screw (large).....
742F	20806	" " " " (small).....
42305	20818	Knife (movable).....
Note: Two No. 42305 are sent with this Machine.		
42306	20818	Knife (movable) Gib.....
42307	20818	" " " Holder.....
42308	-----	" " " 42307 with 133F, 42040 and 42306.....
42038	20818	Knife (movable) Holder Guide with 336F..
42039	20818	" " " " " Plate.....
621E	20818	" " " " " Screw.
336F	20818	" " " " " Set Screw..
133F	20818	" " " " " Screw.....
42040	20818	" " " " " Extension Pin.....
42041	20818	Knife (movable) Holder Spring.....
132562	20804	" " " Lever with 175E.....
132563	20804	" " " " Connection with two 1057E.....
132620	-----	Knife (movable) Lever Connection 132563 with 132649.....

No.	Plate	Name
1057E	20804	Knife (movable) Lever Connection Cap Screw.....
132565	20804	Knife (movable) Lever Connection Hinge Stud.....
175E	20804	Knife (movable) Lever Connection Hinge Stud Set Screw.....
42045	20804	Knife (movable) Lever Hinge Stud.....
1229C	20804	" " " " " Set Screw.....
42309	20818	Knife (stationary) with 42049.....
Note: Two No. 42309 are sent with this Machine.		
42310	20818	Knife (stationary) Clamping Stud.....
1534D	20818	" " " " Thumb Nut
132767	20818	" " " Holder.....
1376C	20818	" " " Regulating Thumb Screw.....
1101C	20818	Knife (stationary) Holder Screw.....
440C	20818	" " " Stop Screw....
1547J	20818	" " " " Nut
42049	20818	" " " Stud.....
42050	20822	Looper (left hand).....
50117C	20822	" " " Clamping Screw.....
132566	20820	" " " Lever with 50117C and two 1253C.....
*132717	-----	Looper (left hand) Lever Connecting Stud
132718	20822	" " " " " " "
		132717 with 68497, 132719 and 132721
132719	20822	Looper (left hand) Lever Connecting Stud Cap.....
132720	20822	Looper (left hand) Lever Connecting Stud Hinge Pin.....
1253C	7406	Looper (left hand) Lever Connecting Stud Hinge Pin Set Screw.....
68497	20822	Looper (left hand) Lever Connecting Stud Oil Pad (wick).....
132721	20822	Looper (left hand) Lever Connecting Stud Oil Pad Retainer.....
132569	20822	Looper (left hand) Lever Hinge Stud with 132552.....
132552	20822	Looper (left hand) Lever Hinge Stud Oil Pad (braided cotton).....
132816	20823	Looper (left hand) Lever Hinge Stud Oil Wick (wick).....
1036C	5569	Looper (left hand) Lever Hinge Stud Set Screw.....
132630	20820	Looper (right hand).....
132698	20820	" " " and Spreader Lever with 233E, 241E and 50200C.....

No.	Plate	Name
132703	-----	Looper (right hand) and Spreader Lever 132698 with 132699.....
*132606	-----	Looper (right hand) and Spreader Lever 132703 with 132566, 132569, 132629, 132718 and 132720 (For factory use only).....
132802	20817	Looper (right hand) and Spreader Lever Ball Stud.....
50200C	7413	Looper (right hand) and Spreader Lever Ball Stud Set Screw.....
132777	20817	Looper (right hand) and Spreader Lever Connection with four 896E.....
132779	-----	Looper (right hand) and Spreader Lever Connection 132777 with 132774, 132775 and 132802.....
896E	20817	Looper (right hand) and Spreader Lever Connection Cap Screw.....
132699	20805	Looper (right hand) and Spreader Lever Hinge Pin with 125056.....
132543	20803	Looper (right hand) and Spreader Lever Hinge Pin Bushing.....
132816	20823	Looper (right hand) and Spreader Lever Hinge Pin Bushing Oil Wick (wick)..
1036C	5569	Looper (right hand) and Spreader Lever Hinge Pin Bushing Set Screw.....
125056	20805	Looper (right hand) and Spreader Lever Hinge Pin Oil Pad (braided cotton).
1036C	5569	Looper (right hand) and Spreader Lever Hinge Pin Set Screw.....
241E	20820	Looper (right hand) and Spreader Lever Oil Plug Screw.....
197J	7414	Looper (right hand) Screw.....
42054	20805	Needle Bar.....
42253	20805	" " Bushing (lower).....
132580	20805	" " " (upper).....
132581	20805	" " " Oil Pad (braided cotton).....
132621	20805	Needle Bar Bushing (upper) Oil Pad Cover
217J	20805	" " " " " " "
		Screw.....
462C	20803	Needle Bar Bushing Set Screw.....
132598	20805	" " Connecting Bracket with 187E and 223F.....
187E	20805	Needle Bar Connecting Bracket Clamping Screw.....
132562	20805	Needle Bar Connecting Link.....
132583	20805	" " " " Hinge Pin with 132584.....

No.	Plate	Name
132584	20805	Needle Bar Connecting Link Hinge Pin Oil Pad (wick).....
223F	20805	Needle Bar Connecting Link Hinge Pin Set Screw for 132598.....
620C	7413	Needle Bar Connecting Link Hinge Pin Set Screw for 132597.....
132585	7413	Needle Bar Connecting Rod with four 1057E.....
1057E	20804	Needle Bar Connecting Rod Cap Screw....
132577	20805	" " " " Guide.....
196F	20805	" " " " " Screw...
132588	7413	" " Crank (back) with 132590 and two 1259C.....
*132573	-----	Needle Bar Crank (back) Ball Stud.....
132695	20805	" " " " " " 132573 with 132696.....
132696	20805	Needle Bar Crank (back) Ball Stud Oil Pad (felt).....
1259C	7413	Needle Bar Crank (back) Ball Stud Set Screw.....
132589	7413	Needle Bar Crank (back) Bushing.....
624C	7413	" " " " " " Set Screw.....
132590	7413	Needle Bar Crank (back) Oil Pad (wick)..
1259C	7413	" " " " " Set Screw.....
132597	7413	" " " " (front) with 620C, 1259C and 50200C.....
132615	-----	Needle Bar Crank (front) 132597 with 132582, 132598 and two 132583.....
1259C	7413	Needle Bar Crank (front) Position Screw.
50200C	7413	" " " " " Set Screw.....
42115	7413	" " Thread Retainer Bracket.....
42483	7413	" " " " " Disc.....
93C	7413	" " " " " Screw.....
10107	7413	" " " " " Spring.....
1728C	20805	" Clamping Nut.....
42066	7413	" Guard.....
171F	7413	" " Screw.....
132679	-----	Presser Foot Body with 735C.....
132680	20809	" " Chaining-off Finger.....
233J	20809	" " " " " Screw..
132609	-----	" " " " " Plate.....
132610	20809	" " " " " Collar with 240C.....
132611	20809	Presser Foot Chaining-off Plate Collar Guide Pin.....
735C	20809	Presser Foot Chaining-off Plate Collar Guide Pin Set Screw.....

No.	Plate	Name
240C	20809	Presser Foot Chaining-off Plate Collar Set Screw.....
14058	20809	Presser Foot Chaining-off Plate Spring..
132681	20809	Presser Foot (solid) complete, for knit goods, Nos. 233J, 14058, 132609 to 132611, 132679 and 132680.....
Note: No. 132681 is sent with this Machine, unless otherwise specified on order.		
1324C	20824	Presser Foot Screw.....
39541	20824	" " " Washer.....
42069	20827	" Lever.....
42045	20804	" " Hinge Stud.....
1120C	20806	" " " " Set Screw.....
42070	7414	" " Lifter.....
85D	7414	" " " Hinge Screw.....
1377C	20807	" " Screw Stud (eccentric)....
1547J	7409	" " " " Nut.....
42071	7414	" " Spring.....
1378D	7414	Pressure Regulating Thumb Screw.....
132631	20820	Spreader.....
197J	7414	" Screw.....
2102	7414	Tension (looper, left hand) Disc.....
1560C	7414	" " " " " " Regulating Thumb Nut.....
50148C	7414	Tension (looper, left hand) Screw Stud..
124687	-----	" " " " " " " " 50148C with 1560C.....
54883	7414	Tension (looper, left hand) Spring.....
132599	7414	" " " " " Thread Guide
2102	7414	" " right hand) Disc.....
1560C	7414	" " " " " Regulating Thumb Nut.....
828C	7414	Tension (looper, right hand) Screw Stud.
42418	-----	" " " " " " " " 828C with 1560C.....
10148	7414	Tension (looper, right hand) Spring.....
2102	7414	" (needle thread) Disc.....
1560C	7414	" " " " " Regulating Thumb Nut.....
916C	7414	Tension (needle thread) Screw Stud.....
44209	-----	" " " " " " " " 916C with 1560C.....
10148	7414	Tension (needle thread) Spring.....
42082	7414	" " " " " Thread Guide....
132629	20806	Thread (looper, left hand) Eyelet.....
233E	20809	" " " " " " Screw.
42122	20806	" " " " " " Nipper Spring (lower).....

No.	Plate	Name
42123	20806	Thread (looper, left hand) Nipper Spring (upper).....
176J	20806	Thread (looper, left hand) Nipper Spring Screw.....
42084	20806	Thread (looper, left hand) Tube.....
462C	20803	" " " " " Set Screw
42128	20806	" " " " " Pull-off.....
132652	20820	" " " " " right hand) Controller..
132653	20820	" " " " " " "
		Eyelet.....
132591	20806	Thread (looper, right hand) Pull-off....
42244	20806	" " " " " " Eye-let.....
207J	20806	Thread (looper, right hand) Pull-off Eyelet Screw.....
132664	20806	Thread (looper, right hand) Staple.....
176J	20806	" " " " " " Screw
7071	20821	" " " " " " " Washer.....
42127	20806	Thread (looper, right hand) Take-up.....
197J	7414	" " " " " " Screw
132622	20806	" (needle) Eyelet.....
223J	20805	" " " " " Screw.....
132623	20806	" " " " " Take-up.....
197J	7414	" " " " " Screw.....
132688	20809	Throat Plate, for 1/8 in. to 3/16 in. bight, for 132668 and 132673.....

Note: No. 132688 is sent with this Machine, unless otherwise specified on order.

742F	20806	Throat Plate Screw.....
*15404	-----	Trade Mark.....
15405	-----	" " Rivet.....

SINGER Needles should be used in SINGER Machines. These Needles and their Containers are marked with the Company's Trade Mark "SIMANCO.**" 1

Needles in Containers marked "FOR SINGER MACHINES" are NOT SINGER made needles. 2

FITTINGS

FOR MACHINE NO. 81-53

	For Knit Goods 1/8" to 3/16" Bight	For Knit Goods 3/16" to 1/4" Bight	For Rayon 3/32" to 5/32" Bight	For Knit Goods with elastic tape inserted in seam 1/8" to 3/16" Bight
Feed (back) Dog.....	132668	132668	132669	132761
Feed (front) Dog.....	132673	132673	132674	132762
Presser Foot (solid).....	132681	132681	-----	132768
Presser Foot (hinged).....	132686	132686	132687	-----
Throat Plate.....	132688	132689	132690	132765
Feed (back) Dog.....	132668	132669	-----	-----
Feed (front) Dog.....	132706	132722	-----	-----
Presser Foot (solid).....	-----	-----	-----	-----
Presser Foot (hinged).....	132708	132708	-----	-----
Throat Plate.....	132709	132723	-----	-----

FITTINGS FOR No. 81-53 MACHINE

FOR KNIT GOODS
FOR 1/8 IN. TO 3/16 IN. BIGHT

No.	Plate	Name
132668	20809	Feed (back) Dog, 10 teeth (16 teeth to the inch).....
132673	20809	Feed (front) Dog, 11 teeth (16 teeth to the inch).....
132679	-----	Presser Foot Body with 735C.....
132680	20809	" " Chaining-off Finger.....
233J	20809	" " " " Screw..
132609	-----	" " " " Plate.....
132610	20809	" " " " Collar with 240C.....
132611	20809	Presser Foot Chaining-off Plate Collar Guide Pin.....
735C	20809	Presser Foot Chaining-off Plate Collar Guide Pin Set Screw.....
240C	20809	Presser Foot Chaining-off Plate Collar Set Screw.....
14058	20809	Presser Foot Chaining-off Plate Spring..
132681	20809	Presser Foot (solid) complete, Nos. 233J 14058,132609 to 132611,132679 and 132680.....
42461	20809	Presser Foot Hinge Pin.....
132683	-----	" " Plate.....
132685	-----	" " Shank with 735C.....
132686	20809	Presser Foot (hinged) complete, Nos.233J 14058,42461,132609 to 132611,132680 132683 and 132685.....
132688	20809	Throat Plate.....

FOR KNIT GOODS
FOR 3/16 IN. TO 1/4 IN. BIGHT

No.	Plate	Name
132668	20810	Feed (back) Dog, 10 teeth (16 teeth to the inch).....
132673	20810	Feed (front) Dog, 11 teeth (16 teeth to the inch).....
132681	20810	Presser Foot (solid) complete, Nos. 233J 14058,132609 to 132611,132679 and 132680.....
132686	20810	Presser Foot (hinged) complete, Nos.233J 14058,42461,132609 to 132611,132680 132683 and 132685.....
132689	20810	Throat Plate.....

FOR RAYON
FOR 3/32 IN. TO 5/32 IN. BIGHT

No.	Plate	Name
132669	20811	Feed (back) Dog, 14 teeth (22 teeth to the inch).....
132674	20811	Feed (front) Dog, 15 teeth (22 teeth to the inch).....
132682	20811	Presser Foot Chaining-off Finger.....
132687	20811	Presser Foot (hinged) complete, Nos.233J 14058,42461,132609 to 132611,132682 132683 and 132685.....
132690	20811	Throat Plate.....

FOR STITCHING COLLARS TO BODIES OF
HEAVY SWEATERS
FOR 3/16 IN. TO 1/4 IN. BIGHT

No.	Plate	Name
132761	20812	Feed (back) Dog, 7 teeth (12 teeth to the inch).....
132762	20812	Feed (front) Dog, 8 teeth (12 teeth to the inch).....
132763	-----	Presser Foot Body with 735C.....
132764	20812	Presser Foot (solid) complete, Nos. 233J 14058,132609 to 132611,132682 and 132763.....
132765	20812	Throat Plate.....

FOR KNIT GOODS WITH ELASTIC TAPE
INSERTED IN THE SEAM
FOR 1/8 IN. TO 3/16 IN. BIGHT

No.	Plate	Name
132761	20813	Feed (back) Dog, 7 teeth (12 teeth to the inch).....
132762	20813	Feed (front) Dog, 8 teeth (12 teeth to the inch).....
132768	20813	Presser Foot (solid) complete, Nos. 233J 14058,132609 to 132611,132679 and 132682.....
132765	20813	Throat Plate.....

FOR BLIND STITCHING
FOR KNIT GOODS

No.	Plate	Name
132669	20814	Feed (back) Dog, 10 teeth (16 teeth to the inch).....
132706	20814	Feed (front) Dog, 11 teeth (16 teeth to the inch).....
132707	-----	Presser Foot Plate.....
132708	20814	Presser Foot (hinged) complete, Nos.233J 14058,42461,132609 to 132611,132682 132685 and 132707.....
132709	20814	Throat Plate.....

FOR BLIND STITCHING
FOR RAYON

No.	Plate	Name
132669	20815	Feed (back) Dog, 14 teeth (22 teeth to the inch).....
132722	20815	Feed (front) Dog, 16 teeth (22 teeth to the inch).....
132708	20815	Presser Foot (hinged) complete, Nos.233J 14058,42461,132609 to 132611,132682 132685 and 132707.....
132723	20815	Throat Plate.....

SINGER Needles should be used
in SINGER Machines
These Needles and their Containers
are marked with the
Company's Trade Mark "SIMANCO.**" 1

Needles in Containers marked
"FOR SINGER MACHINES"
are NOT SINGER made needles. 2

MACHINE No. 81-56

For Trimming, Overedging and Blind Stitch Hemming or Welting in Knit Underwear. Three-thread stitch. Foot Lifter. Gathering feed. Speed up to 5000 R. P. M. on short runs, depending on the material being stitched.

NOTE: THIS MACHINE IS THE SAME AS THE 81-53 MACHINE WITH THE FOLLOWING EXCEPTIONS.

No.	Plate	Name
42147	7406	Feed (back) Bar, in place of 132665.....
61C	7406	" " " Hinge Screw, in place of 1132C.....
42148	7406	Feed (back) Connecting Link, in place of 132667.....
1132C	7406	Feed (back) Connecting Link Hinge Screw.
42149	20816	" " Dog, 3 teeth (16 teeth to the inch) in place of 132668.....
42150	7406	Feed (back) Regulator, in place of 132670.....
1132C	7406	Feed (back) Regulator Hinge Screw.....
190J	7406	" " " Set Screw.....
1444C	7406	" " " Thumb Screw.....
42151	7406	" (front) Bar with 1253C, in place of 132671.....
*132624	-----	Feed (front) Bar 42151 with 61C, 42147, 42148, 42150, 132528, 132539, 132541 and two 1132C, in place of 132672 (For factory use only).....
132619	-----	Feed (front) Connecting Rod 132529 with 132534, in place of 132643.....
42182	20816	Feed (front) Dog, 17 teeth (16 teeth to the inch) in place of 132673.....
*132702	-----	Feed (front) Eccentric Body, in place of 132532.....
132534	7407	Feed (front) Eccentric complete, Nos. 201J, 19047, 51145C, 132531, 132533, 132702 and two 1036C, in place of 132644.....
132540	7406	Feed (front) Rock Shaft, in place of 132675.....
132541	-----	Feed (front) Rock Shaft complete, Nos. 1444C, 42021 and 132540, in place of 132676.....

No.	Plate	Name
42213	7409	Knife (movable) in place of 42305.....
Note: Two No. 42213 are sent with this Machine.		
42214	7409	Knife (movable) Gib, in place of 42306..
42035	7409	" " Holder, in place of 42307.....
132827	-----	Knife (movable) Holder 42035 with 133F, 42037, 42040, 42214 and two 404E, in place of 42308.....
42037	7409	Knife (movable) Holder Cap.....
404E	7409	" " " " Screw.....
42046	20804	" (stationary) with 42049, in place of 42309.....
Note: Two No. 42046 are sent with this Machine.		
42048	20804	Knife (stationary) Clamping Stud, in place of 42310.....
132766	20804	Knife (stationary) Holder, in place of 132767.....
*132639	-----	Looper (right hand) and Spreader Lever 132703 with 42242, 132566, 132569, 132718 and 132720 (For factory use only) in place of 132606.....
42183	-----	Presser Foot Body.....
42184	20816	" " Chaining-off Finger.....
233J	20816	" " " " Screw..
9320	20816	" " Hinge Pin.....
42159	-----	" " Plate.....
14058	20816	" " Spring.....
42160	20816	" " " Adjusting Pin.....
464C	20816	" " " " " Set Screw.....
42185	20816	Presser Foot (spring hinged) complete, Nos. 233J, 464C, 9320, 14058, 42159, 42160, 42183 and 42184, in place of 132681.....
42242	20820	Thread (looper, left hand) Eyelet, in place of 132629.....
42452	20816	Throat Plate for 42149 and 42182, in place of 132688.....

WELT GUIDE

No.	Plate	Name
42473	20825	Welt Guide.....
42475	20825	" " Hinge (female half).....
42476	20825	" " " (male half).....
42474	20825	" " " Pin.....
42477	20825	" " " Rivet.....
132710	20825	" " Holder.....
*132758	-----	" " " 132710 with 190J, 1117J 1209C and 22436 (For factory use only).....
1209C	20825	Welt Guide Holder Screw.....
22436	20825	" " " " Washer.....
1117J	20825	" " Regulating Thumb Screw.....
190J	20825	" " Screw.....
42478	20825	" " Spring.....
132869	-----	" " " 42478 with 42475 and two 42477.....
42188	20825	Welt Guide (hinged) complete, Nos. 42473 42474, 42476, 132869 and two 42477...

SINGER Needles should be used
in SINGER Machines
These Needles and their Containers
are marked with the
Company's Trade Mark "SIMANCO.**" ¹

Needles in Containers marked
"FOR SINGER MACHINES"
are NOT SINGER made needles. ²

ACCESSORIES

No.	Plate	Name
1408J	20826	Machine Base Thumb Screw, for 1 5/8 in. tables and Individual Stands, for use when machine is mounted on top of table.....
474J	20826	Machine Base Thumb Screw, for use when machine is mounted 1 1/2 in. lower than standard.....
14063	20807	Machine Base Thumb Screw Spring, for Thumb Screw No. 1408, when machine is mounted on Individual Stand.....
27498	20826	Machine Base Thumb Screw Spring, for Thumb Screw No.1408 on 1 5/8 in. Tables and Thumb Screw No. 474 when machine is mounted 1 1/2 in. lower than standard.....
9842	7419	Machine Base Thumb Screw Spring Washer..
132802	20807	" " " " Washer.....
120344	5566	Oiler (copper plated) with 120345.....
120345	5566	" Spout, 5 in. long.....
120440	5566	Screw Driver.....
42090	5566	Threading Wire.....
120341	5566	Tweezers (curved).....
42089	5566	Wrench for 1324.....
8908	5566	" " 1520.....
4822	5566	" " 1547.....

BENCH STANDS

BENCH STAND NO. 79768

FOR MACHINE BASE NO. 132592

WHEN MACHINE IS MOUNTED ON TOP

OF TABLE

No.	Plate	Name
79768	-----	Bench Stand with 27998, two each 28291, 46548, wood screws 1 1/2 in. No. 12 F.H. and eight wood screws 5/8 in. No.5 F.H.....
28291	20807	Cover Hinge with two each wood screws 1/2 in.No.5 F.H. and 5/8 in.No.5 F.H

No.	Plate	Name
27998	20807	Cover Hook and Eye (brass) with wood screw 1/2 in. No. 5 F.H.....
46548	20807	Cover Rest (felt).....

BENCH STAND NO. 79790

FOR MACHINE BASE NO. 132656

WHEN MACHINE IS MOUNTED 1 1/2 IN. LOWER THAN STANDARD
FOR FRONT PLANKS NOS. 123882 TO 123885

No.	Plate	Name
79790	-----	Bench Stand with 27998,60820, two each 28291,46548,150244, three each wood screws 1 1/4 in. No. 12 F.H., 1 1/2 in. No. 14 F.H. and eight wood screws 1/2 in. No. 5 F.H.....
60820	-----	Cover Chain, 9 1/4 in. long with two 56865.....
56865	20807	Cover Chain Hook.....
150244	20826	" " " Screw Eye.....
28291	20807	" Hinge with two each wood screws 1/2 in. No. 5 F.H. and 5/8 in. No.5 F.H.....
27998	20807	Cover Hook and Eye (brass) with wood screw 1/2 in. No. 5 F.H.....
46548	20807	Cover Rest (felt).....

FOOT LIFTER PARTS

No.	Plate	Name
6439	-----	Chain, 38 in. to 45 in., with 56864 and 56865.....
Note: When ordering No. 6439, state length required		
4879	5566	Chain Connecting Link.....
56864	5566	" Hook (large).....
56865	20807	" " (small).....
42130	20824	Lifting Lever.....
42131	20824	" " Bracket.....
1229C	20804	" " Screw.....
1301D	20824	" " Hinge Screw.....
42132	20824	" " Spring.....
1148F	20824	" " Stop Screw.....

FOOT LIFTER PARTS

No.	Plate	Name
1547J	7409	Lifting Lever Stop Screw Nut.....
4881	20808	Treadle.....
4882	5566	" Shaft.....
4883	5566	" Spring.....
4884	20808	" Stand.....
4885	20808	Treadle complete, Nos. 4879,4881 to 4884 and two wood screws 1 in. No. 16...
42133	-----	Foot Lifter complete, Nos. 1301D,4885, 6439,42130 to 42132 and two each 1148F,1229C and 1547J.....

KNEE LIFTER PARTS

No.	Plate	Name
42130	20824	Lifting Lever.....
42131	20824	" " Bracket.....
1229C	20804	" " " Screw.....
42142	20808	" " Connecting Rod.....
1301D	20824	" " Hinge Screw.....
42132	20824	" " Spring.....
1148F	20824	" " Stop Screw.....
1547J	7409	" " " Nut.....
2763	20808	Rock Shaft.....
12242	20808	" " Hanger with two wood screws 1 in. No. 10.....
2765	20808	Rock Shaft Knee Arm.....
2766	20808	" " " " Hub with 356C.....
356C	20807	" " " " " Set Screw.....
2768	-----	Rock Shaft Knee Arm complete, Nos. 2765 to 2767.....
2767	20808	Rock Shaft Knee Plate with 356C.....
356C	20807	" " " " " Set Screw.....
6337	20808	" " Lifting Bracket with two 356C
7125	20808	" " " " Hook.....
356C	20807	" " " " " Set Screw
356C	20807	" " " " " Set Screw...
2770	20808	" " Stop Dog with 356C.....
356C	20807	" " " " " Set Screw.....
42143	20808	Rock Shaft complete, Nos. 2763,2768,6337 7125 and two each 2770 and 12242...
42144	-----	Knee Lifter complete, Nos. 1301D,42130 to 42132,42142,42143 and two each 1148F,1229C and 1547J.....

KNIFE GRINDERS

KNIFE GRINDER NO. 41819

FOR KNIVES NOS. 42305 AND 42309

FOR MACHINE NO. 81-53

No.	Plate	Name
41326	20829	Emery Wheel.....
1508C	5569	" " Clamping Nut.....
41327	20829	" " Shaft.....
41328	20829	" " " Pulley with 1036C.....
1036C	5569	" " " " Set Screw.....
41513	5569	" " Washer.....
41329	20830	Frame with 1036C.....
878D	5569	" Oil Hole Stop Screw.....
41818	20829	Knife Holder with two 14222.....
150210	-----	" " 41818 with 970D,41331,41332 and two each 313C,771D,1519J,41333 and 41334.....
41331	20829	Knife Holder Bracket with 157E.....
157E	5569	" " " Clamping Screw....
42065	5569	" " " Hinge Stud.....
1036C	5569	" " " " " Set Screw
717C	5569	" " " Stop Screw.....
1520J	5569	" " " " Nut....
41333	5569	" " Clamp.....
41334	5569	" " " Spring.....
14222	5569	" " " Steady Pin.....
771D	5569	" " " Thumb Screw.....
970D	5569	" " Regulating Thumb Screw....
313C	5569	" " Screw Center.....
1519J	5569	" " " " Nut.....
41332	5569	" " Spring.....
41819	-----	Knife Grinder complete, Nos. 717C,1508C, 1520J,41326 to 41329,42065,150210, two each 878D,41513 and three wood screws 1 1/4 in. No. 12.....

KNIFE GRINDER NO. 41335
 FOR KNIVES NOS. 42046 AND 42213
 FOR MACHINE NO. 81-56
 THIS KNIFE GRINDER IS THE SAME AS NO. 41819
 WITH THE FOLLOWING EXCEPTIONS

No.	Plate	Name
41330	20829	Knife Holder with two 14222, in place of 41818.....
150209	-----	Knife Holder 41330 with 970D,41331,41332 and two each 313C,771D,1519J,41333 and 41334, in place of 150210.....
41335	-----	Knife Grinder complete, Nos. 717C,1508C, 1520J,41326 to 41329,42065,150209, two each 878D,41513 and three wood screws 1 1/4 in. No. 12.....

MACHINE BASES

MACHINE BASE NO. 132592
 WHEN MACHINE IS MOUNTED ON TOP
 OF TABLE
 FOR USE WITH BENCH STAND NO. 79768

No.	Plate	Name
132647	20808	Machine Base.....
132595	7419	" " Cushion (large) felt.....
42088	7419	" " (small) felt.....
132618	7419	" " " " " for 474 or 1408.....
935E	7419	Machine Base Cushion (small) Screw.....
132596	7419	" " " (leather).....
132593	7419	" " Oil Drain Strainer.....
54477	7419	" " Screw Stud.....
51576E	7419	" " " Nut.....
9842	7419	" " " Washer.....
132594	7419	" " Thumb Screw Bushing.....

No.	Plate	Name
132592	-----	Machine Base complete, Nos.132593,132596 132618,132647, three each 9842, 51576E,54477 and four each 935E, 42088 and 132595.....
132704	-----	Machine Base and Oil Drain Jar complete, Nos.131268 and 132592.....

MACHINE BASE NO. 132656

WHEN MACHINE IS MOUNTED 1/2 IN.
 LOWER THAN STANDARD
 FOR USE WITH BENCH STAND NO. 79790

No.	Plate	Name
132655	20830	Machine Base.....
	1204E	" " Position Stud.....
131022	20824	" " " " Bushing (rub-ber).....
132656	-----	Machine Base complete, Nos.132593,132596 132618,132655, three each 1204E, 131022 and four each 935E,42088 and 132595.....
132705	-----	Machine Base and Oil Drain Jar complete, Nos.132656 and 132697.....

MACHINE BASE OIL DRAIN JARS

MACHINE BASE OIL DRAIN JAR
 SWINGING TYPE
OIL DRAIN JAR NO. 131268
 FOR MACHINE BASE NO. 132592
 FOR BENCH STAND NO. 79768

No.	Plate	Name
131185	20828	Jar (glass).....
131191	20828	" Cap.....
131188	20828	" Clamp.....
131217	-----	" " 131188 with 131189.....
131189	20828	" " Lever.....
1247C	20824	" " " Hinge Screw.....

No.	Plate	Name
131265	20828	Nipple (long).....
131266	20828	" (short).....
131267	20828	" Elbow.....
131268	-----	Machine Base Oil Drain Jar (swinging type) complete, Nos. 131185,131191, 131217,131266 and two each 1247C, 131265 and 131267.....

MACHINE BASE OIL DRAIN JAR

SWINGING TYPE

OIL DRAIN JAR NO. 132697

FOR MACHINE BASE NO. 132656

FOR BENCH STAND NO. 79790

No.	Plate	Name
132697	-----	Machine Base Oil Drain Jar (swinging type) complete, Nos. 131185,131191, 131217,131265 and two each 1247C, 131266 and 131267.....

THREAD UNWINDER

FOR THREE SPOOLS

No.	Plate	Name
225259	20778	Spool Rest (for one spool) with 201018C.
225257	20778	" " " two spools) with 201018C
150203	20778	" " Cushion (felt).....
225388	20778	" " Rod.....
200383C	20807	" " Set Screw.....
201018C	20807	" " Set Screw.....
202490	20778	" Stand with 200383C.....
225391	20778	Thread Guide.....
201696J	20807	" " Lock Nut.....
225326	20807	" " Position Cup.....
225324	20778	" " Rod with 208E and 225322....
208E	7409	" " Screw.....
225322	20807	" " Washer.....
*150057	-----	" Separator.....
150058	20778	" " 150057 with 150059.....
*150059	-----	" " Bracket.....

No.	Plate	Name
150060	20778	Thread Separator Bracket Arm with 164J and 9525.....
164J	20807	Thread Separator Bracket Arm Clamping Screw.....
9525	20807	Thread Separator Bracket Arm Clamping Screw Washer.....
164J	20807	Thread Separator Bracket Screw.....
9525	20807	" " " " Washer...
150061	-----	Thread Separator complete, Nos. 164J, 9525,150058 and 150060.....
150178	20778	Thread Unwinder complete, Nos. 150061, 201696J,202490,225257,225259,225324 225326,225388 and three each 150203 225391 and wood screws 7/8 in. No. 12.....
27739	20778	Thread Cone (wood) for large cones.....
225390	20778	" " Holder, for inverted cones..

Note: Nos. 27739 and 225390 are used with, but not included in 150178.

OBSOLETE PARTS

No.	Plate	Name
*132713	-----	Frame Rotary Shaft Bushing (front) use 132862.....
132714	20802	Frame Rotary Shaft Bushing (front) 132713 with 132552,132715 and 132716, use 132863.....
132552	20822	Frame Rotary Shaft Bushing (front) Oil Pad (braided cotton).....
132553	20803	Frame Rotary Shaft Crank with 1036C and 1375C, superseded by 132775, not interchangeable.....
132716	20802	Frame Rotary Shaft Crank Oil Sling Cover, superseded by 132835, not interchangeable.....
*132554	-----	Frame Rotary Shaft Flanged Bushing (back) use 132965.....
132694	20802	Frame Rotary Shaft Flanged Bushing (back) 132554 with 132555,132556, 132603 and 132692, use 132866.....
132555	20802	Frame Rotary Shaft Flanged Bushing (back) Oil Pad (large) braided cotton, superseded by 132867, not interchangeable.....

No.	Plate	Name
132556	20802	Frame Rotary Shaft Flanged Bushing (back) Oil Pad (small) braided cotton, superseded by 132868, not interchangeable.....
*132573	-----	Looper (right hand) and Spreader Lever Ball Stud.....
132695	20805	Looper (right hand) and Spreader Lever Ball Stud 132573 with 132696.....
132696	20805	Looper (right hand) and Spreader Lever Ball Stud Oil Pad (felt).....
132574	20805	Looper (right hand) and Spreader Lever Connection with four 1057E, superseded by 132777, not interchangeable.....
132617	-----	Looper (right hand) and Spreader Lever Connection 132574 with 132553 and 132695, use 132779.....
1057E	20804	Looper (right hand) and Spreader Lever Connection Cap Screw.....
132577	20805	Looper (right hand) and Spreader Lever Connection Guide.....
196F	20805	Looper (right hand) and Spreader Lever Connection Guide Screw.....

**SINGER Needles should be used
in SINGER Machines
These Needles and their Containers
are marked with the
Company's Trade Mark "SIMANCO.**" 1**

**Needles in Containers marked
"FOR SINGER MACHINES"
are NOT SINGER made needles. 2**

NUMERICAL LIST OF PARTS

No.	Plate	Name
61C	7406	Feed (back) Bar Hinge Screw for 132624..
85D	7414	Presser Lever Lifter Hinge Screw.....
93C	7413	Needle Bar Thread Retainer Screw.....
133F	20818	Knife (movable) Holder Screw for 42308 and 132627.....
157E	20803	Feed (front) Rock Shaft Crank Clamping Screw for 42021.....
157E	5569	Knife Grinder Knife Holder Bracket Clamping Screw for 41331.....
164J	20807	Thread Unwinder Thread Separator Bracket Arm Clamping Screw for 150060.....
164J	20807	Thread Unwinder Thread Separator Bracket Screw for 150061.....
171C	7413	Feed (front) Connecting Rod Hinge Screw Clamping Screw for 132529.....
171F	7413	Needle Guard Screw.....
175E	20804	Knife (movable) Lever Connection Hinge Stud Set Screw for 132562.....
176J	20806	Frame Top Cover Extension Screw for 132600.....
176J	20806	Thread (looper, left hand) Nipper Spring Screw.....
176J	20806	Thread (looper, right hand) Staple Screw
187E	20805	Needle Bar Connecting Bracket Clamping Screw for 132598.....
190E	7406	Feed (front) Dog Screw.....
190E	7406	Frame Bottom Cover Screw.....
190J	7406	Feed (back) Regulator Set Screw for 81-56 Machine.....
190J	20825	Welt Guide Screw for 132758.....
198F	20805	Looper (right hand) and Spreader Lever Connection Guide Screw, obsolete...
196F	20805	Needle Bar Connecting Rod Guide Screw...
197J	7414	Frame Top Cover Oil Reservoir Cover Screw for 132781.....
197J	7414	Looper (right hand) Screw.....
197J	7414	Spreader Screw.....
197J	7414	Thread (looper, right hand) Take-up Screw.....
197J	7414	Thread Needle Take-up Screw.....
201J	7407	Feed (front) Eccentric Clamping Washer Screw for 132534 and 132644.....
203E	20824	Feed (back) Dog Screw.....

No.	Plate	Name
207J	20806	Thread (looper, right hand) Pull-off Eyelet Screw.....
208E	7409	Thread Unwinder Thread Guide Rod Screw for 225324.....
217J	20805	Needle Bar Bushing (upper) Oil Pad Cover Screw.....
223F	20805	Needle Bar Connecting Link Hinge Pin Set Screw for 132598.....
223J	20805	Thread (needle) Eyelet Screw.....
233E	20809	Cloth Plate Extension (lower) Screw for 132527.....
233E	20809	Cloth Plate Extension (upper) Screw for 132527.....
233E	20809	Thread (looper, left hand) Eyelet Screw for 132698.....
233J	20809	Presser Foot Chaining-off Finger Screw for 42185, 132681, 132686, 132687, 132708, 132764 and 132768.....
236C	20821	Cloth Plate Lock Spring Screw for 132527
240C	20809	Presser Foot Chaining-off Plate Collar Set Screw for 132610.....
241E	20820	Looper (right hand) and Spreader Lever Oil Plug Screw for 132698.....
283W	7409	Frame Top Cover Extension Holder Thumb Screw.....
313C	5569	Knife Grinder Knife Holder Screw Center for 150209 and 150210.....
330W	20821	Frame Side Cover (left) Screw.....
330W	20821	" " " (right) Screw.....
336F	20818	Knife (movable) Holder Guide Set Screw for 42038.....
356C	20807	Rock Shaft Knee Arm Hub Set Screw for 2766.....
356C	20807	Rock Shaft Knee Plate Set Screw for 2767
356C	20807	" " Lifting Bracket Hook Set Screw for 6337.....
356C	20807	Rock Shaft Lifting Bracket Set Screw for 6337.....
356C	20807	Rock Shaft Stop Dog Set Screw for 2770..
404E	7409	Knife (movable) Holder Cap Screw for 132627.....
440C	20818	Knife (stationary) Holder Stop Screw....
446C	7409	Balance Wheel Set Screw for 132632.....
462C	20803	Feed (front) Lifting Eccentric Set Screw for 132649.....
462C	20803	Needle Bar Bushing Set Screw for 132522.
462C	20803	Thread (looper, left hand) Tube Set Screw.....

No.	Plate	Name
464C	20816	Presser Foot Spring Adjusting Pin Set Screw for 42185.....
474J	20826	Machine Base Thumb Screw, for use when machine is mounted 1 1/2 inch lower than standard (Accessories).....
583F	20806	Frame Top Cover Screw (large).....
620C	7413	Needle Bar Connecting Link Hinge Pin Set Screw for 132597.....
621E	20818	Knife (movable) Holder Guide Plate Screw
624C	7413	Needle Bar Crank (back) Bushing Set Screw for 132522.....
717C	5569	Knife Grinder Knife Holder Bracket Stop Screw for 41335 and 41819.....
735C	20809	Presser Foot Chaining-off Plate Collar Guide Pin Set Screw for 132679 and 132685.....
742F	20806	Frame Top Cover Screw (small).....
742F	20806	Throat Plate Screw.....
771D	5569	Knife Grinder Knife Holder Clamp Thumb Screw for 150209 and 150210.....
828C	7414	Tension (looper, right hand) Screw Stud for 42418.....
879D	5569	Knife Grinder Frame Oil Hole Stop Screw for 41335 and 41319.....
896E	20817	Looper (right hand) and Spreader Lever Connection Cap Screw for 132777....
916C	7414	Tension (needle thread) Screw Stud for 44209.....
935E	7413	Machine Base Cushion (small) Screw for 132592 and 132656.....
949E	20806	Arm Screw.....
970D	5569	Knife Grinder Knife Holder Regulating Thumb Screw for 150209 and 150210..
1036C	5569	Feed (front) Eccentric Body Set Screw for 132534 and 132644.....
1036C	20803	Feed (front) Rock Shaft Hinge Pin Bushing Set Screw.....
1036C	20817	Frame Rotary Shaft Crank Set Screw for 132553 and 132769.....
1036C	5569	Looper (left hand) Lever Hinge Stud Set Screw.....
1036C	5569	Looper (right hand) and Spreader Lever Hinge Pin Bushing Set Screw.....
1036C	5569	Looper (right hand) and Spreader Lever Hinge Pin Set Screw.....
1036C	5569	Knife Grinder Emery Wheel Shaft Pulley Set Screw for 41325.....
1036C	5569	Knife Grinder Knife Holder Bracket Hinge Stud Set Screw for 41329.....

No.	Plate	Name
1057E	20804	Feed (front) Connecting Rod Cap Screw for 132529.....
1057E	20804	Knife (movable) Lever Connection Cap Screw for 132563.....
1057E	20804	Looper (right hand) and Spreader Lever Connection Cap Screw for 132574, obsolete.....
1057E	20804	Needle Bar Connecting Rod Cap Screw for 132585.....
1101C	20818	Knife (stationary) Holder Screw.....
1117J	20825	Welt Guide Regulating Thumb Screw for 132758.....
1120C	20806	Presser Lever Hinge Stud Set Screw.....
1132C	20819	Feed (back) Bar Hinge Screw for 132672..
1132C	7406	" " Connecting Link Hinge Screw for 132624.....
1132C	7406	Feed (back) Regulator Hinge Screw for 132624.....
1148F	20824	Lifting Lever Stop Screw for 42133 and 42144.....
1204E	20824	Machine Base Position Stud for 132656...
1209C	20825	Welt Guide Holder Screw for 132758.....
1229C	20804	Knife (movable) Lever Hinge Stud Set Screw.....
1229C	20804	Lifting Lever Bracket Screw for 42133 and 42144.....
1247C	20824	Machine Base Oil Drain Jar Clamp Lever Hinge Screw for 131268 and 132697..
1253C	7406	Feed (front) Bar Hinge Pin Set Screw for 42151 and 132671.....
1253C	7406	Looper (left hand) Lever Connecting Stud Hinge Pin Set Screw for 132566.....
1259C	7413	Needle Bar Crank (back) Ball Stud Set Screw for 132588.....
1259C	7413	Needle Bar Crank (back) Set Screw for 132588.....
1259C	7413	Needle Bar Crank (front) Position Screw for 132597.....
1255C	20807	Balance Wheel Position Screw for 132632.
1301D	20824	Lifting Lever Hinge Screw for 42133 and 42144.....
1324C	20324	Presser Foot Screw.....
1375C	20317	Frame Rotary Shaft Crank Position Screw for 132553 and 132769.....
1376C	20318	Knife (stationary) Holder Regulating Thumb Screw.....
1377C	20807	Presser Lever Screw Stud (eccentric)....
1378D	7414	Pressure Regulating Thumb Screw.....

No.	Plate	Name
1408J	20826	Machine Base Thumb Screw for 1 5/8 in. tables and Individual Stands, for use when machine is mounted on top of table (Accessories).....
1444C	7406	Feed (back) Regulator Thumb Screw for 132541.....
1508C	5569	Knife Grinder Emery Wheel Clamping Nut for 41335 and 41819.....
1519J	5569	Knife Grinder Knife Holder Screw Center Nut for 150209 and 150210.....
1520J	5569	Feed (front) Connecting Rod Hinge Screw Nut.....
1520J	5569	Knife Grinder Knife Holder Bracket Stop Screw Nut for 41335 and 41819.....
1534D	20818	Knife (stationary) Clamping Stud Thumb Nut.....
1547J	20818	Knife (stationary) Holder Stop Screw Nut
1547J	7409	Lifting Lever Stop Screw Nut for 42133 and 42144.....
1547J	7409	Presser Lever Screw Stud Nut.....
1560C	7414	Tension (looper, left hand) Regulating Thumb Nut for 124687.....
1560C	7414	Tension (looper, right hand) Regulating Thumb Nut for 42418.....
1560C	7414	Tension (needle thread) Regulating Thumb Nut for 44209.....
1664E	20817	Frame Rotary Shaft Crank Ball Sleeve Bushing Nut for 132775.....
1695J	7407	Feed (front) Connecting Rod Hinge Screw Clamping Screw Nut for 132529.....
1728C	20805	Needle Clamping Nut.....
2102	7414	Tension (looper, left hand) Disc.....
2102	7414	" " right hand) Disc.....
2102	7414	" (needle thread) Disc.....
2763	20808	Rock Shaft for 42143.....
2765	20808	" " Knee Arm, for 2768.....
2766	20808	" " " " Hub with 356C, for 2768.....
2767	20808	Rock Shaft Knee Plate with 356C, for 2768.....
2768	-----	Rock Shaft Knee Arm complete, for 42143, Nos. 2765 to 2767.....
2770	20808	Rock Shaft Stop Dog with 356C, for 42143
4389	20821	Arm Dowel Pin.....
4822	5566	Wrench for 1547 (Accessories).....
4879	5566	Chain Connecting Link for 4885.....
4881	20808	Treadle for 4885.....
4882	5566	" Shaft for 4885.....

No.	Plate	Name
4883	5566	Treadle Spring for 4885.....
4884	20808	" Stand for 4885.....
4885	20808	Treadle complete for 42133, Nos. 4879, 4881 to 4884 and two wood screws 1 in. No.16.....
6337	20808	Rock Shaft Lifting Bracket with two 356C for 42143.....
6439	-----	Chain, 36 in. to 45 in. with 56864 and 56865, for 42133.....
7071	20821	Thread (looper, right hand) Staple Screw Washer.....
7125	20808	Rock Shaft Lifting Bracket Hook for 42143.....
8908	5566	Wrench for 1520 (Accessories).....
9320	20816	Presser Foot Hinge Pin for 42185.....
9525	20807	Thread Unwinder Thread Separator Bracket Arm Clamping Screw Washer for 150080.....
9525	20807	Thread Unwinder Thread Separator Bracket Screw Washer for 150061.....
9842	7419	Machine Base Screw Stud Nut Washer for 132592.....
9842	7419	Machine Base Thumb Screw Spring Washer (Accessories).....
10107	7413	Needle Bar Thread Retainer Spring.....
10148	7414	Tension (looper, right hand) Spring.....
10148	7414	" (needle thread) Spring.....
12242	20808	Rock Shaft Hanger with two wood screws 1 in. No. 10 for 42143.....
14058	20809	Presser Foot Chaining-off Plate Spring for 132681, 132686, 132687, 132708, 132764 and 132768.....
14058	20809	Presser Foot Spring for 42185.....
14063	20807	Machine Base Thumb Screw Spring, for Thumb Screw No. 1408, when machine is mounted on individual stand (Accessories).....
14222	5569	Knife Grinder Knife Holder Clamp Steady Pin for 41330 and 41818.....
•15404	-----	Trade Mark for 132522.....
15405	-----	" " Rivet for 132522.....
19044	7409	Frame Top Cover Extension Holder Thumb Screw Washer.....
19047	7407	Feed (front) Eccentric Clamping Washer for 132534 and 132644.....
22436	20825	Welt Guide Holder Screw Washer for 132758.....

No.	Plate	Name
27498	20826	Machine Base Thumb Screw Spring, for Thumb Screw No. 1408 on 1 5/8 inch tables and Thumb Screw No. 474 when machine is mounted 1 1/2 inch lower than standard (Accessories).
27739	20778	Thread Unwinder Thread Cone (wood) for large cones, for 150178.....
27998	20807	Bench Stand Cover Hook and Eye (brass) with wood screw 1/2 in. No. 5 F.H. for 79768 and 79790.....
28291	20807	Bench Stand Cover Hinge with two each wood screws 1/2 in. No. 5 F.H. and 5/8 in. No. 5 F.H., for 79768 and 79790.....
39541	20824	Presser Foot Screw Washer.....
41326	20829	Knife Grinder Emery Wheel for 41335 and 41819.....
41327	20829	Knife Grinder Emery Wheel Shaft for 41335 and 41819.....
41328	20829	Knife Grinder Emery Wheel Shaft Pulley with 1036C, for 41335 and 41819...
41329	20830	Knife Grinder Frame with 1036C for 41335 and 41819.....
41330	20829	Knife Grinder Knife Holder with two 14222, for 150209.....
41331	20829	Knife Grinder Knife Holder Bracket with 157E, for 150209 and 150210.....
41332	5569	Knife Grinder Knife Holder Spring for 150209 and 150210.....
41333	5569	Knife Grinder Knife Holder Clamp for 150209 and 150210.....
41334	5569	Knife Grinder Knife Holder Clamp Spring for 150209 and 150210.....
41335	-----	Knife Grinder complete, for Knives, Nos. 42046 and 42213, for 81-56 Machine Nos. 717C, 1508C, 1520J, 41326 to 41329, 42065, 150209, two each 878D, 41513 and three wood screws 1 1/4 in. No. 12.....
41513	5569	Knife Grinder Emery Wheel Washer for 41335 and 41819.....
41818	20829	Knife Grinder Knife Holder with two 14222, for 150210.....
41819	-----	Knife Grinder complete for Knives, Nos. 42305 and 42309, for 81-53 Machine Nos. 717C, 1508C, 1520J, 41326 to 41329, 42065, 150210, two each 878D, 41513 and three wood screws 1 1/4 in. No. 12.....

No.	Plate	Name
42005	20821	Cloth Plate Lock Spring for 132527.....
42021	20803	Feed (front) Rock Shaft Crank with 157E, for 132541 and 132676.....
42028	20827	Frame Side Cover (right) Hinged.....
42035	7409	Knife (movable) Holder for 132627.....
42037	7409	" " " Cap for 132627...
42038	20818	" " " Guide with 336F, for 81-53 Machine.....
42039	20818	Knife (movable) Holder Guide Plate for 81-53 Machine.....
42040	20818	Knife (movable) Holder Screw Extension Pin for 42308 and 132627.....
42041	20818	Knife (movable) Holder Spring.....
42045	20804	" " Lever Hinge Stud.....
42045	20804	Presser Lever Hinge Stud.....
42046	20804	Knife (stationary) with 42049, for 81-56 Machine.....
42048	20804	Knife (stationary) Clamping Stud for 81-56 Machine.....
42049	20818	Knife (stationary) Stud for 42046 and 42309.....
42050	20822	Looper (left hand).....
42054	20805	Needle Bar.....
42065	5569	Knife Grinder Knife Holder Bracket Hinge Stud for 41335 and 41819.....
42066	7413	Needle Guard.....
42069	20827	Presser Lever.....
42070	7414	" " Lifter.....
42071	7414	" " Spring.....
42082	7414	Tension (needle thread) Thread Guide....
42084	20806	Thread (looper, left hand) Tube.....
42088	7419	Machine Base Cushion (small) felt, for 132592 and 132656.....
42089	5566	Wrench for 1324 (Accessories).....
42090	5566	Threading Wire (Accessories).....
42101	20821	Frame Side Cover (right) Lock Spring for 132600.....
42102	7409	Frame Top Cover Extension Holder for 132600.....
42108	20821	Cloth Plate Extension (upper) for 132527
42115	7413	Needle Bar Thread Retainer Bracket.....
42122	20806	Thread (looper, left hand) Nipper Spring (lower).....
42123	20806	Thread (looper, left hand) Nipper Spring (upper).....
42126	20806	Thread (looper, left hand) Pull-off.....
42127	20806	" (looper, right hand) Take-up.....
42130	20824	Lifting Lever for 42133 and 42144.....

No.	Plate	Name
42131	20824	Lifting Lever Bracket for 42133 and 42144.....
42132	20824	Lifting Lever Spring for 42133 and 42144.....
42133	-----	Foot Lifter complete, Nos. 1301D,4885, 6439,42130 to 42132 and two each 1148F,1229C and 1547J.....
42142	20808	Lifting Lever Connecting Rod for 42144.
42143	20808	Rock Shaft complete for 42144, Nos.2763, 2768,6337,7125 and two each 2770 and 12242.....
42144	-----	Knee Lifter complete, Nos. 1301D,42130 to 42132,42142,42143 and two each 1148F,1229C and 1547J.....
42147	7406	Feed (back) Bar for 132624.....
42148	7406	Feed (back) Connecting Link for 132624.
42149	20816	" " Dog, 3 teeth (16 teeth to the inch) for 42452, for 81-56 Ma- chine.....
42150	7406	Feed (back) Regulator for 132624.....
42151	7406	" (front) Bar with 1253C, for 132624
42159	-----	Presser Foot Plate for 42185.....
42160	20816	" " Spring Adjusting Pin for 42185.....
42182	20816	Feed (front) Dog, 17 teeth (16 teeth to the inch) for 42452, for 81-56 Ma- chine.....
42183	-----	Presser Foot Body for 42185.....
42184	20816	" " Chaining-off Finger, for 42185.....
42185	20816	Presser Foot (spring hinged) complete, for 81-56 Machine, Nos. 233J,464C, 9320,14058,42159,42160,42183 and 42184.....
42188	20825	Welt Guide (hinged) complete, for blind stitch welting, for 81-56 Machine, Nos. 42473,42474,42476,132869 and two 42477.....
42213	7409	Knife (movable) for 81-56 Machine.....
42214	7409	" " Gib for 132627.....
42242	20820	Thread (looper, left hand) Eyelet for 132639.....
42244	20806	Thread (looper, right hand) Pull-off Eyelet.....
42253	20805	Needle Bar Bushing (lower) for 132522..
42305	20818	Knife (movable).....
42306	20818	" " Gib for 42303.....
42307	20818	" " Holder for 42303.....

No.	Plate	Name
42308	-----	Knife (movable) Holder 42307 with 133F, 42040 and 42306, for 81-53 Machine.
42309	20818	Knife (stationary) with 42049, for 81-53 Machine.....
42310	20818	Knife (stationary) Clamping Stud for 81-53 Machine.....
42418	-----	Tension (looper, right hand) Screw Stud 828C with 1560C.....
42452	20816	Throat Plate, for 42149 and 42182, for Heavy Work for 81-56 Machine.....
42461	20809	Presser Foot Hinge Pin for 132686, 132687 and 132708.....
42473	20825	Welt Guide for 42188.....
42474	20825	" " Hinge Pin for 42188.....
42475	20825	" " " (female half) for 132869.....
42476	20825	Welt Guide Hinge (male half) for 42188..
42477	20825	" " " Rivet for 42188 and 132869.....
42478	20825	Welt Guide Spring for 132869.....
42483	7413	Needle Bar Thumb Retainer Disc.....
44209	-----	Tension (needle thread) Screw Stud 916C with 1560C.....
46548	20807	Bench Stand Cover Rest (felt) for 79768 and 79790.....
50117C	20822	Looper (left hand) Clamping Screw for 132566.....
50148C	7414	Tension (looper, left hand) Screw Stud for 124687.....
50150C	20821	Cloth Plate Hinge Stud Set Screw.....
50200C	7413	Looper (right hand) and Spreader Lever Ball Stud Set Screw for 132698.....
50200C	7413	Needle Bar Crank (front) Set Screw for 132597.....
50253J	7407	Feed (front) Eccentric Cover Screw for 132600.....
51145C	7407	Feed (front) Regulating Screw for 132534 and 132644.....
51292C	7407	Feed (front) Connecting Rod Hinge Screw.
51332C	20821	Frame Rotary Shaft Bushing (front) Set Screw.....
51332C	20821	Frame Rotary Shaft Flanged Bushing (back) Set Screw.....
51360W	20819	Feed (back) Regulator Position Screw for 132672.....
51576E	7419	Machine Base Screw Stud Nut for 132592..
54477	7419	" " " " for 132592.....
54883	7414	Tension (looper, left hand) Spring.....

No.	Plate	Name
56864	5566	Chain Hook (large) for 6439.....
56865	20807	Bench Stand Cover Chain Hook for 60820..
56865	20807	Chain Hook (small) for 6439.....
60820	-----	Bench Stand Cover Chain 9 1/4 in. long with two 56865, for 79790.....
68350	20821	Arm Oil Cup.....
68497	20822	Looper (left hand) Lever Connecting Stud Oil Pad (wick) for 132718.....
79768	-----	Bench Stand with 27998, two each 28291, 46548, wood screws 1 1/2 in. No. 12 F.H. and eight wood screws 5/8 in. No. 5 F.H., for Machine Base No. 132592, for use when machine is mounted on top of table.....
79790	-----	Bench Stand with 27998, 60820, two each 28291, 46548, 150244, three each wood screws 1 1/4 in. No. 12 F.H., 1 1/2 in. No. 14 F.H. and eight wood screws 1/2 in. No. 5 F.H., for Machine Base No. 132656, for use when machine is mounted 1 1/2 in. lower than standard, for Front Planks, Nos. 123882 to 123885.....
120341	5566	Tweezers (curved) Accessories.....
120344	5566	Oiler (copper plated) with 120345 (Accessories).....
120345	5566	Oiler Spout, 5 in. long, for 120344.....
120440	5566	Screw Driver (Accessories).....
124687	-----	Tension (looper, left hand) Screw Stud 50148C with 1560C.....
125056	20805	Looper (right hand) and Spreader Lever Hinge Pin Oil Pad (braided cotton) for 132699.....
131022	20824	Machine Base Position Stud Bushing (rubber) for 132656.....
131185	20828	Machine Base Oil Drain Jar (glass) for 131268 and 132697.....
131188	20828	Machine Base Oil Drain Jar Clamp for 131217.....
131189	20828	Machine Base Oil Drain Jar Clamp Lever for 131217.....
131191	20828	Machine Base Oil Drain Jar Cap for 131268 and 132697.....
131217	-----	Machine Base Oil Drain Jar Clamp 131188 with 131189, for 131268 and 132697.
131265	20828	Machine Base Oil Drain Jar Nipple (long) for 131268 and 132697.....
131266	20828	Machine Base Oil Drain Jar Nipple (short) for 131268 and 132697.....

No.	Plate	Name
131267	20828	Machine Base Oil Drain Jar Nipple Elbow for 131268 and 132697.....
131268	-----	Machine Base Oil Drain Jar (swinging type) complete for 132704, Nos. 131185, 131191, 131217, 131266 and two each 1247C, 131265 and 131267.....
*132522	-----	Arm with 15404, 42253, 132580 and two each 462C, 624C, 15405 and 132589.....
132524	20808	Cloth Plate with 132525, for 132527.....
*132525	-----	" " Hinge Bracket for 132524....
132526	20821	" " Stud.....
132527	-----	Cloth Plate complete, Nos. 42005, 42108, 132524, 132601, two 236C and five 233E.....
132528	7406	Feed (front) Bar Hinge Pin for 132624 and 132672.....
132529	7407	Feed (front) Connecting Rod with 171C, 1695J and two 1057E, for 132619 and 132643.....
*132531	-----	Feed (front) Eccentric for 132534 and 132644.....
*132532	-----	Feed (front) Eccentric Body for 132644..
132533	7407	" " " Oil Tube for 132534 and 132644.....
132534	7407	Feed (front) Eccentric complete for 132619, Nos. 201J, 19047, 51145C, 132531, 132533, 132702 and two 1036C.
132537	20803	Feed (front) Eccentric Lubricator Oil Wick (braided cotton) for 132785...
132539	20803	Feed (front) Lifting Eccentric Connection for 132624 and 132672.....
132540	7406	Feed (front) Rock Shaft for 132541.....
132541	-----	Feed (front) Rock Shaft complete for 132624, Nos. 1444C, 42021 and 132540
132542	20803	Feed (front) Rock Shaft Hinge Pin with 132544.....
132543	20803	Feed (front) Rock Shaft Hinge Pin Bushing.....
132543	20803	Looper (right hand) and Spreader Lever Hinge Pin Bushing.....
132544	20803	Feed (front) Rock Shaft Hinge Pin Oil Wick (braided cotton) for 132542...
*132545	-----	Frame.....
132546	20808	" Bottom Cover with 132594.....
132547	20808	" " " Gasket.....
132548	20821	" Oil Cup.....
132549	20827	" Rotary Shaft with 132558 and 132559, for 132616.....

No.	Plate	Name
132552	20822	Frame Rotary Shaft Bushing (front) Oil Pad (braided cotton) for 132714, obsolete.....
132552	20822	Looper (left hand) Lever Hinge Stud Oil Pad (braided cotton) for 132569....
132553	20803	Frame Rotary Shaft Crank with 1036C and 1375C, for 132617, obsolete, superseded by 132775 not interchangeable
*132554	-----	Frame Rotary Shaft Flanged Bushing (back) for 132694, obsolete, use 132865.....
132555	20802	Frame Rotary Shaft Flanged Bushing (back) Oil Pad (large) braided cotton, for 132694, obsolete, superseded by 132867 not interchangeable
132556	20802	Frame Rotary Shaft Flanged Bushing (back) Oil Pad (small) braided cotton, for 132694, obsolete, superseded by 132868 not interchangeable
132558	20823	Frame Rotary Shaft Oil Pad (braided cotton) for 132549.....
132559	20823	Frame Rotary Shaft Oil Pad Retainer for 132549.....
132560	20827	Frame Side Cover (left) with 132701.....
132562	20804	Knife (movable) Lever with 175E.....
132563	20804	" " " Connection with two 1057E, for 132620.....
132565	20804	Knife (movable) Lever Connection Hinge Stud.....
132566	20820	Looper (left hand) Lever with 50117C and two 1253C, for 132606 and 132639...
132569	20822	Looper (left hand) Lever Hinge Stud with 132552, for 132606 and 132639.....
*132573	-----	Looper (right hand) and Spreader Lever Ball Stud for 132695, obsolete....
*132573	-----	Needle Bar Crank (back) Ball Stud for 132695.....
132574	20805	Looper (right hand) and Spreader Lever Connection with four 1057E, for 132617, obsolete, superseded by 132777, not interchangeable.....
132577	20805	Looper (right hand) and Spreader Lever Connection Guide, obsolete.....
132577	20805	Needle Bar Connecting Rod Guide.....
132580	20805	" " Bushing (upper) for 132522...
132581	20805	" " " " Oil Pad (braided cotton).....
132582	20805	Needle Bar Connecting Link for 132615...

No.	Plate	Name
132583	20805	Needle Bar Connecting Link Hinge Pin with 132584, for 132615.....
132584	20805	Needle Bar Connecting Link Hinge Pin Oil Pad (wick) for 132583.....
132585	7413	Needle Bar Connecting Rod with four 1057E, for 132616.....
132588	7413	Needle Bar Crank (back) with 132590 and two 1259C.....
132589	7413	Needle Bar Crank (back) Bushing for 132522.....
132590	7413	Needle Bar Crank (back) Oil Pad Wick for 132588.....
132591	20806	Thread (looper, right hand) Pull-off....
132592	-----	Machine Base complete, for 132704, Nos. 132593, 132596, 132618, 132647, three each 9842, 51576E, 54477 and four each 935E, 42088 and 132595.....
132593	7419	Machine Base Oil Drain Strainer for 132592 and 132656.....
132594	7419	Machine Base Thumb Screw Bushing for 132546.....
132595	7419	Machine Base Cushion (large) felt, for 132592 and 132656.....
132596	7419	Machine Base Cushion (leather) for 132592 and 132656.....
132597	7413	Needle Bar Crank (front) with 620C, 1259C and 50200C, for 132615.....
132598	20805	Needle Bar Connecting Bracket with 187E and 223F, for 132615.....
132599	7414	Tension (looper, left hand) Thread Guide
132600	-----	Frame Top Cover Extension Holder 42102 with 42101, 132650, 132651 and two each 176J and 50253J.....
132601	20808	Cloth Plate Extension (lower) for 132527
132602	20807	Machine Base Thumb Screw Washer (Accessories).....
132603	20827	Frame Rotary Shaft Flanged Bushing (back) Oil Pad Retainer for 132694 and 132866.....
*132606	-----	Looper (right hand) and Spreader Lever 132703 with 132566, 132569, 132629, 132718 and 132720 (For factory use only).....
132609	-----	Presser Foot Chaining-off Plate for 132681, 132686, 132687, 132708, 132764 and 132768.....
132610	20809	Presser Foot Chaining-off Plate Collar with 240C, for 132681, 132686, 132687 132708, 132764 and 132768.....

No.	Plate	Name
132611	20809	Presser Foot Chaining-off Plate Collar Guide Pin for 132681, 132686, 132687, 132708, 132764 and 132768.....
132615	-----	Needle Bar Crank (front) 132597 with 132582, 132598 and two 132583.....
132616	-----	Frame Rotary Shaft 132549 with 132585 and 132695.....
132617	-----	Looper (right hand) and Spreader Lever Connection 132574 with 132553 and 132695, obsolete, use 132779.....
132618	7419	Machine Base Cushion (small) felt, for 474 or 1408, for 132592 and 132656.
132619	-----	Feed (front) Connecting Rod 132529 with 132534, for 81-56 Machine.....
132620	-----	Knife (movable) Lever Connection 132563 with 132649.....
132621	20805	Needle Bar Bushing (upper) Oil Pad Cover
132622	20806	Thread (needle) Eyelet.....
132623	20806	" " Take-up.....
*132624	-----	Feed (front) Bar 42151 with 61C, 42147, 42148, 42150, 132528, 132539, 132541 and two 1132C, for 81-56 Machine (For factory use only).....
132627	-----	Knife (movable) Holder 42055 with 133F, 42037, 42040, 42214 and two 404E, for 81-56 Machine.....
132629	20806	Thread (looper, left hand) Eyelet for 132606.....
132630	20820	Looper (right hand).....
132631	20820	Spreader.....
132632	20827	Balance Wheel 1 7/8 in. pulley with 446C and 1285C.....
*132639	-----	Looper (right hand) and Spreader Lever 132703 with 42242, 132566, 132569, 132718 and 132720, for 81-56 Machine (For factory use only).....
132643	-----	Feed (front) Connecting Rod 132529 with 132644, for 81-53 Machine.....
132644	20822	Feed (front) Eccentric (adjustable) complete, for 132643, Nos. 201J, 19047, 51145C, 132531 to 132533 and two 1036C.....
132647	20808	Machine Base for 132592.....
132649	20803	Feed (front) Lifting Eccentric with two 462C, for 132620.....
132650	7409	Frame Top Cover Extension for 132600....
132651	7407	Feed (front) Eccentric Cover for 132600.
132652	20820	Thread (looper, right hand) Controller..

No.	Plate	Name
132653	20820	Thread (looper, right hand) Controller Eyelet.....
132654	20827	Chip Guard.....
132655	20830	Machine Base for 132656.....
132656	-----	Machine Base complete for 132705, Nos. 132593, 132596, 132618, 132655, three each 1204E, 131022 and four each 935E, 42088 and 132595.....
132664	20806	Thread (looper, right hand) Staple.....
132665	20819	Feed (back) Bar for 132672.....
132666	20819	" " " Hinge Pin (hollow) for 132672.....
132667	20819	Feed (back) Connecting Link for 132672..
132668	20809	" " Dog, 10 teeth (16 teeth to the inch) for 132688, 132689 and 132709, for Knit Goods, for 1/8 in. to 1/4 in. bight and for Blind Stitching Knit Goods, for 81-53 Machine and for 132709, for Blind Stitch Welting, for 81-56 Machine..
132669	20811	Feed (back) Dog, 14 teeth (22 teeth to the inch) for 132690 and 132723, for Rayon, for 3/32 in. to 5/32 in. bight and also for Blind Stitching Rayon, for 81-53 Machine.....
132670	20819	Feed (back) Regulator for 132672.....
132671	20819	" (front) Bar with 1253C, for 132672.
*132672	-----	" " " 132671 with 1132C, 51360W, 132528, 132539, 132665 to 132667, 132670 and 132676, for 81-53 Machine (For factory use only).....
132673	20809	Feed (front) Dog, 11 teeth (16 teeth to the inch) for 132688 and 132689, for Knit Goods, for 1/8 in. to 1/4 in. bight, for 81-53 Machine.....
132674	20811	Feed (front) Dog, 15 teeth (22 teeth to the inch) for 132690, for Rayon, for 3/32 in. to 5/32 in. bight for 81-53 Machine.....
132675	20819	Feed (front) Rock Shaft for 132676.....
132676	-----	Feed (front) Rock Shaft complete, for 132672, Nos. 42021 and 132675.....
132679	-----	Presser Foot Body with 735C, for 132681 and 132769.....
132680	20809	Presser Foot Chaining-off Finger for 132681 and 132686.....

No.	Plate	Name
132681	20309	Presser Foot (solid) complete, for Knit Goods, for 1/8 in. to 1/4 in. bight, for 81-53 Machine, Nos. 233J, 14058, 132609 to 132611, 132679 and 132680.
132682	20811	Presser Foot Chaining-off Finger for 132697, 132708, 132764 and 132768....
132683	-----	Presser Foot Plate for 132686 and 132687
132685	-----	" " Shank with 735C, for 132686 132687 and 132708.....
132686	20809	Presser Foot (hinged) complete for Knit Goods, for 1/8 in. to 1/4 in. bight for 81-53 Machine, Nos. 233J, 14058, 42461, 132609 to 132611, 132680, 132683 and 132685.....
132687	20811	Presser Foot (hinged) complete, for Rayon, for 3/32 in. to 5/32 in. bight, for 81-53 Machine, Nos. 233J, 14058, 42461, 132609 to 132611, 132682, 132683 and 132685.....
132688	20809	Throat Plate for 1/8 in. to 3/16 in. bight, for 132668 and 132673, for Knit Goods, for 81-53 Machine.....
132689	20810	Throat Plate for 3/16 in. to 1/4 in. bight for 132668 and 132673, for Knit Goods, for 81-53 Machine.....
132690	20811	Throat Plate for 3/32 in. to 5/32 in. bight, for 132669 and 132674, for Rayon, for 81-53 Machine.....
*132692	20827	Frame Rotary Shaft Oil Sling Cover for 132694 and 132866.....
132694	20802	Frame Rotary Shaft Flanged Bushing (back) 132554 with 132555, 132556, 132603 and 132692, obsolete, use 132866.....
132695	20805	Looper (right hand) and Spreader Lever Ball Stud 132573 with 132696, for 132617, obsolete.....
132695	20805	Needle Bar Crank (back) Ball Stud 132573 with 132696, for 132616.....
132696	20805	Looper (right hand) and Spreader Lever Ball Stud Oil Pad (felt) for 132695 obsolete.....
132696	20805	Needle Bar Crank (back) Ball Stud Oil Pad (felt) for 132695.....
132697	-----	Machine Base Oil Drain Jar (swinging type) complete, for 132705, Nos. 131185, 131191, 131217, 131265 and two each 1247C, 131266 and 131267.....

No.	Plate	Name
132698	20820	Looper (right hand) and Spreader Lever with 233E, 241E and 50200C, for 132703.....
132699	20805	Looper (right hand) and Spreader Lever Hinge Pin with 125056, for 132703..
132701	20821	Frame Side Cover (left) Handle for 132560.....
*132702	-----	Feed (front) Eccentric Body for 132534..
132703	-----	Looper (right hand) and Spreader Lever 132698 with 132699, for 132606 and 132639.....
132704	-----	Machine Base and Oil Drain Jar complete, for Machine Base No. 132592, when Machine is mounted on top of table, for use with Bench Stand No. 79768, Nos. 131268 and 132592.....
132705	-----	Machine Base and Oil Drain Jar complete, for Machine Base No. 132656, when Machine is mounted 1 1/2 inch lower than standard, for use with Bench Stand No. 79790, Nos. 132656 and 132697.....
132706	20814	Feed Front Dog, 11 teeth (16 teeth to the inch) for 132709, for Blind Stitching, for Knit Goods, for 81-53 Machine and for 132709, for Blind Stitch Welting, for 81-56 Machine.....
132707	-----	Presser Foot Plate for 132708.....
132708	20814	Presser Foot (hinged) complete, for Blind Stitching, for Knit Goods and Rayon, for 81-53 Machine and for Blind Stitch Welting, for 81-56 Machine, Nos. 233J, 14058, 42461, 132609 to 132611, 132682, 132685 and 132707.
132709	20814	Throat Plate for 132668 and 132706, for Blind Stitching, for Knit Goods, for 81-53 Machine and for Blind Stitch Welting, for 81-56 Machine..
132710	20825	Welt Guide Holder for 132758.....
132712	20822	Feed (front) Eccentric Lint Cover (spring).....
*132713	-----	Frame Rotary Shaft Bushing (front) for 132714, obsolete, use 132862.....
132714	20802	Frame Rotary Shaft Bushing (front) 132713 with 132552, 132715 and 132716, obsolete, use 132863.....

No.	Plate	Name
132715	20817	Frame Rotary Shaft Bushing (front) Oil Pad Retainer for 132714 and 132863.
132716	20802	Frame Rotary Shaft Crank Oil Sling Cover for 132714, obsolete, superseded by 132835, not interchangeable.....
*132717	-----	Looper (left hand) Lever Connecting Stud for 132718.....
132718	20822	Looper (left hand) Lever Connecting Stud 132717 with 68497, 132719 and 132721 for 132606 and 132639.....
132719	20822	Looper (left hand) Lever Connecting Stud Cap for 132718.....
132720	20822	Looper (left hand) Lever Connecting Stud Hinge Pin for 132606 and 132639....
132721	20822	Looper (left hand) Lever Connecting Stud Oil Pad Retainer for 132718.....
132722	20815	Feed (front) Dog, 16 teeth (22 teeth to the inch) for 132723, for Blind Stitching, for Rayon, for 81-53 Machine.....
132723	20815	Throat Plate for 132669 and 132722, for Blind Stitching, for Rayon, for 81-53 Machine.....
*132758	-----	Welt Guide Holder 132710 with 190J, 1117J 1209C and 22436, for 81-56 Machine (For factory use only).....
132761	20812	Feed (back) Dog, 7 teeth (12 teeth to the inch) for 132765, for Stitching Collars to Bodies of Heavy Sweaters for 3/16 in. to 1/4 in. bight and for Knit Goods with Elastic Tape inserted in the seam, for 1/8 in. to 3/16 in. bight, for 81-53 Machine..
132762	20812	Feed (front) Dog, 8 teeth (12 teeth to the inch) for 132765, for Stitching Collars to Bodies of Heavy Sweaters for 3/16 in. to 1/4 in. bight and for Knit Goods with Elastic Tape inserted in the seam, for 1/8 in. to 3/16 in. bight, for 81-53 Machine..
132763	-----	Presser Foot Body with 735C, for 132764.
132764	20812	Presser Foot (solid) complete, for Stitching Collars to Bodies of Heavy Sweaters, for 3/16 in. to 1/4 in. bight, for 81-53 Machine, Nos. 233J, 14058, 132609 to 132611, 132682 and 132763.....

No.	Plate	Name
132765	20812	Throat Plate for 132761 and 132762, for Stitching Collars to Bodies of Heavy Sweaters, for 3/16 in. to 1/4 in. bight and for Knit Goods with Elastic Tape inserted in the seam, for 1/8 in. to 3/16 in. bight, for 81-53 Machine.....
132766	20804	Knife (stationary) Holder for 81-56 Machine.....
132767	20818	Knife (stationary) Holder for 81-53 Machine.....
132768	20813	Presser Foot (solid) complete, for Knit Goods with Elastic Tape inserted in the seam, for 1/8 in. to 3/16 in. bight, for 81-53 Machine, Nos. 233J 14058, 132609 to 132611, 132679 and 132682.....
132769	20817	Frame Rotary Shaft Crank with 1036C, 1375C and 132773, for 132775.....
132770	20817	Frame Rotary Shaft Crank Ball Sleeve for 132775.....
132771	20817	Frame Rotary Shaft Crank Ball Sleeve Bushing for 132775.....
132772	20817	Frame Rotary Shaft Crank Ball Sleeve Bushing Nut Washer for 132775.....
132773	-----	Frame Rotary Shaft Crank Ball Sleeve Bushing Position Pin for 132769....
132774	20817	Frame Rotary Shaft Crank Ball Sleeve Guide for 132779.....
132775	-----	Frame Rotary Shaft Crank complete, for 132779, Nos. 1664E and 132769 to 132772.....
132777	20817	Looper (right hand) and Spreader Lever Connection with four 896E, for 132779.....
132779	-----	Looper (right hand) and Spreader Lever Connection 132777 with 132774, 132775 and 132802.....
132780	20808	Frame Top Cover for 132781.....
132781	-----	" " " 132780 with 132782 to 132784 and two 197J.....
132782	20821	Frame Top Cover Oil Reservoir Cover for 132781.....
132783	20821	Frame Top Cover Oil Tube for 132781.....
132784	20821	" " " " Wick for 132781.....
132785	20803	Feed (front) Eccentric Lubricator with 132537.....
132802	20817	Looper (right hand) and Spreader Lever Ball Stud for 132779.....

No.	Plate	Name
132816	20823	Feed (front) Rock Shaft Hinge Pin Bushing Oil Wick (wick).....
132816	20823	Looper (left hand) Lever Hinge Stud Oil Wick (wick).....
132816	20823	Looper (right hand) and Spreader Lever Hinge Pin Bushing Oil Wick (wick)..
132817	20823	Frame Rotary Shaft Bushing (front) Oil Wick (wick).....
132817	20823	Frame Rotary Shaft Flanged Bushing (back) Oil Wick (wick).....
132835	20817	Frame Rotary Shaft Crank Oil Sling Cover for 132863.....
*132862	-----	Frame Rotary Shaft Bushing (front) for 132863.....
132863	20817	Frame Rotary Shaft Bushing (front) 132862 with 132835, 132864 and two 132715.....
132864	20823	Frame Rotary Shaft Bushing (front) Oil Pad (braided cotton) for 132863....
*132865	-----	Frame Rotary Shaft Flanged Bushing (back) for 132866.....
132866	20827	Frame Rotary Shaft Flanged Bushing (back) 132865 with 132692, 132867, 132868 and two 132603.....
132867	20823	Frame Rotary Shaft Flanged Bushing (back) Oil Pad (large) braided cotton, for 132866.....
132868	20823	Frame Rotary Shaft Flanged Bushing (back) Oil Pad (small) braided cotton, for 132866.....
132869	-----	Welt Guide Spring 42478 with 42475 and two 42477, for 42188.....
*150057	-----	Thread Unwinder Thread Separator, for 150058.....
150058	20778	Thread Unwinder Thread Separator 150057 with 150059, for 150061.....
*150059	-----	Thread Unwinder Thread Separator Bracket for 150058.....
150060	20778	Thread Unwinder Thread Separator Bracket Arm with 164J and 9525, for 150061.
150061	-----	Thread Unwinder Thread Separator complete, for 150173, Nos. 164J, 9525, 150058 and 150060.....
150178	20778	Thread Unwinder complete, for three spools, Nos. 150061, 201696J, 20249C, 225257, 225259, 225324, 225326, 225388 and three each 150203, 225391 and wood screws 7/8 in. No. 12.....

No.	Plate	Name
150203	20778	Thread Unwinder Spool Rest Cushion (felt) for 150178.....
150209	-----	Knife Grinder Knife Holder 41330 with 970D,41331,41332 and two each 313C, 771D,1519J,41333 and 41334, for 41335.....
150210	-----	Knife Grinder Knife Holder 41813 with 970D,41331,41332 and two each 313C, 771D,1519J,41333 and 41334, for 41819.....
150244	20826	Bench Stand Cover Chain Hook Screw Eye for 79790.....
200383C	20807	Thread Unwinder Spool Rest Rod Set Screw for 202490.....
201018C	20907	Thread Unwinder Spool Rest Set Screw for 225257 and 225259.....
201696J	20807	Thread Unwinder Thread Guide Lock Nut for 150178.....
202490	20778	Thread Unwinder Spool Stand with 200383C for 150178.....
225257	20778	Thread Unwinder Spool Rest (for two spools) with 201018C, for 150178....
225259	20778	Thread Unwinder Spool Rest (for one spool) with 201018C, for 150178....
225322	20307	Thread Unwinder Thread Guide Rod Washer for 225324.....
225324	20778	Thread Unwinder Thread Guide Rod with 203E and 225322, for 150178.....
225326	20907	Thread Unwinder Thread Guide Position Cup for 150178.....
225383	20778	Thread Unwinder Spool Rest Rod for 150178.....
225390	20778	Thread Unwinder Thread Cone Holder for inverted cones, for 150178.....
225391	20778	Thread Unwinder Thread Guide for 150178.

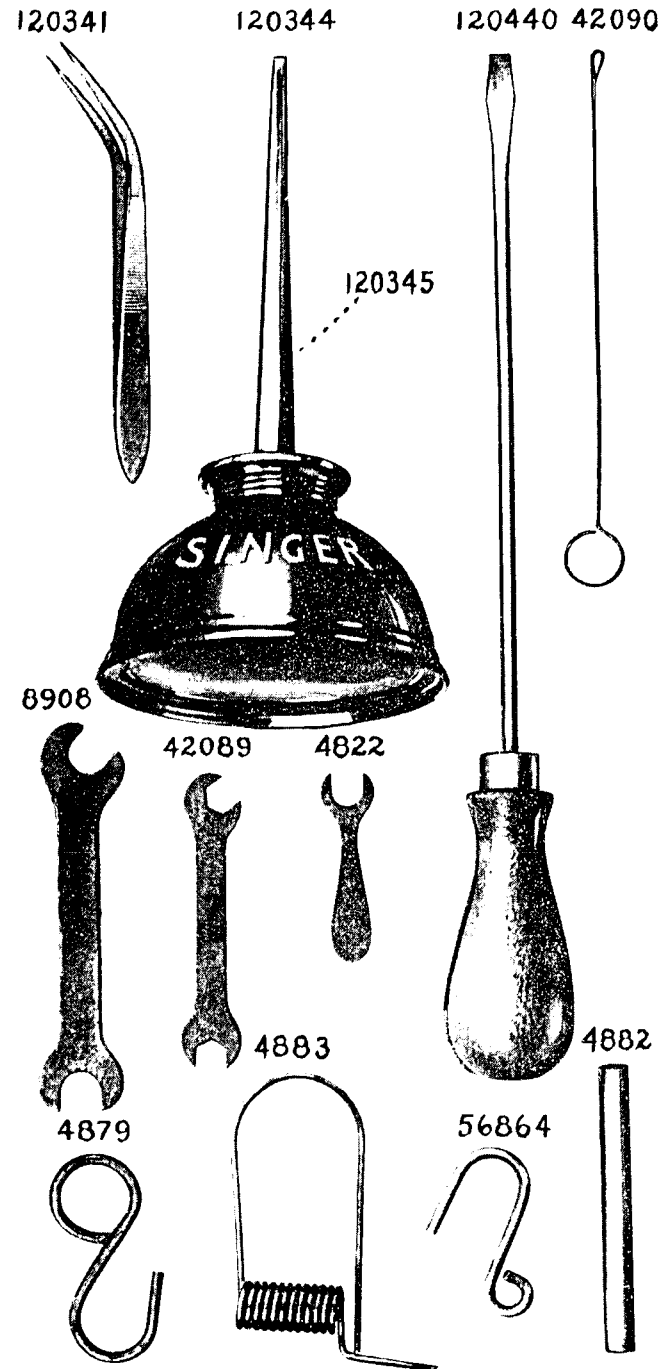


PLATE 5569—FULL SIZE

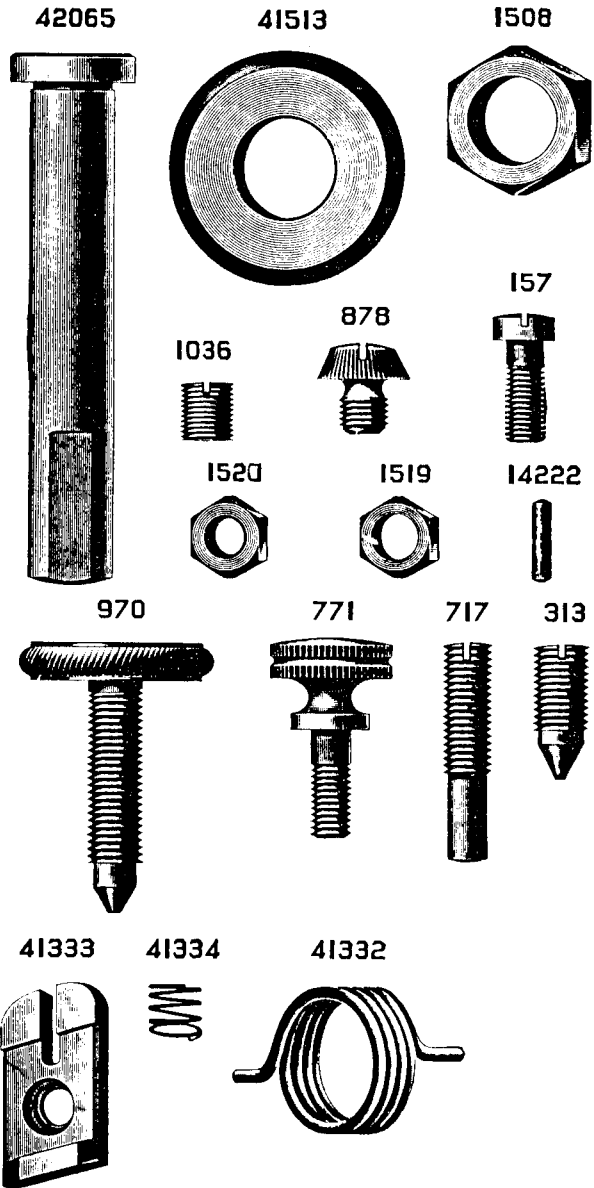


PLATE 7406—FULL SIZE

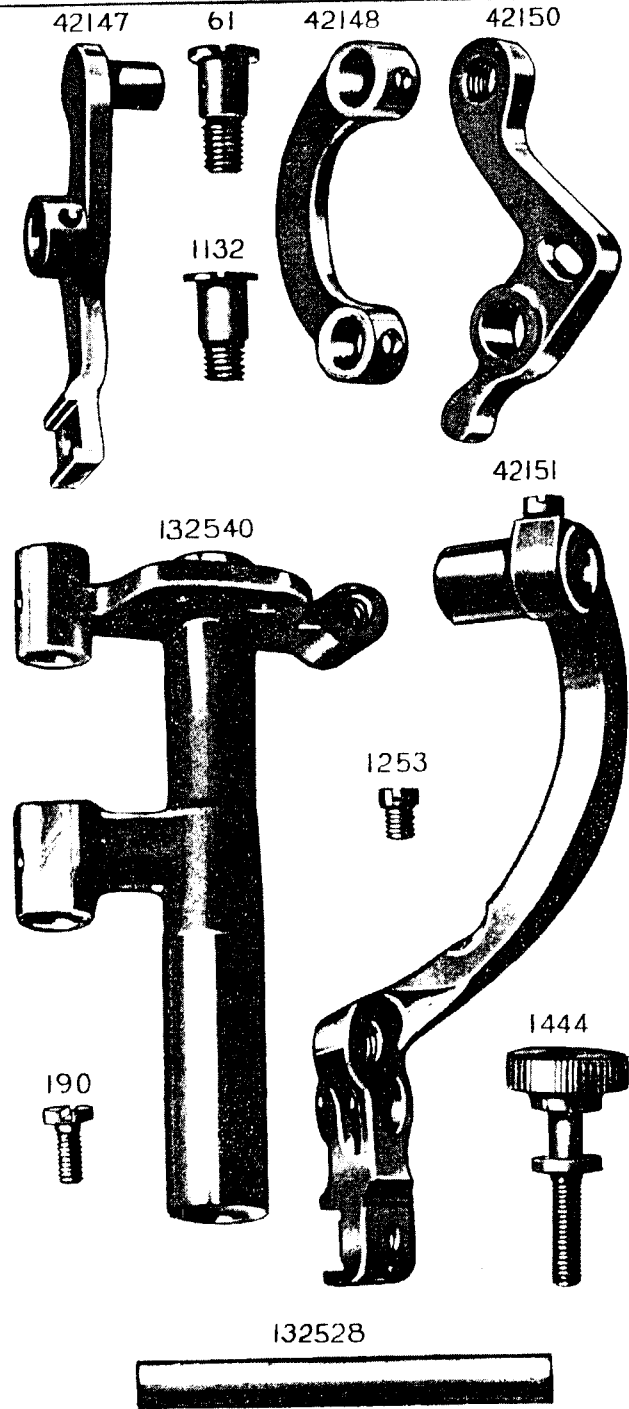


PLATE 7407—FULL SIZE

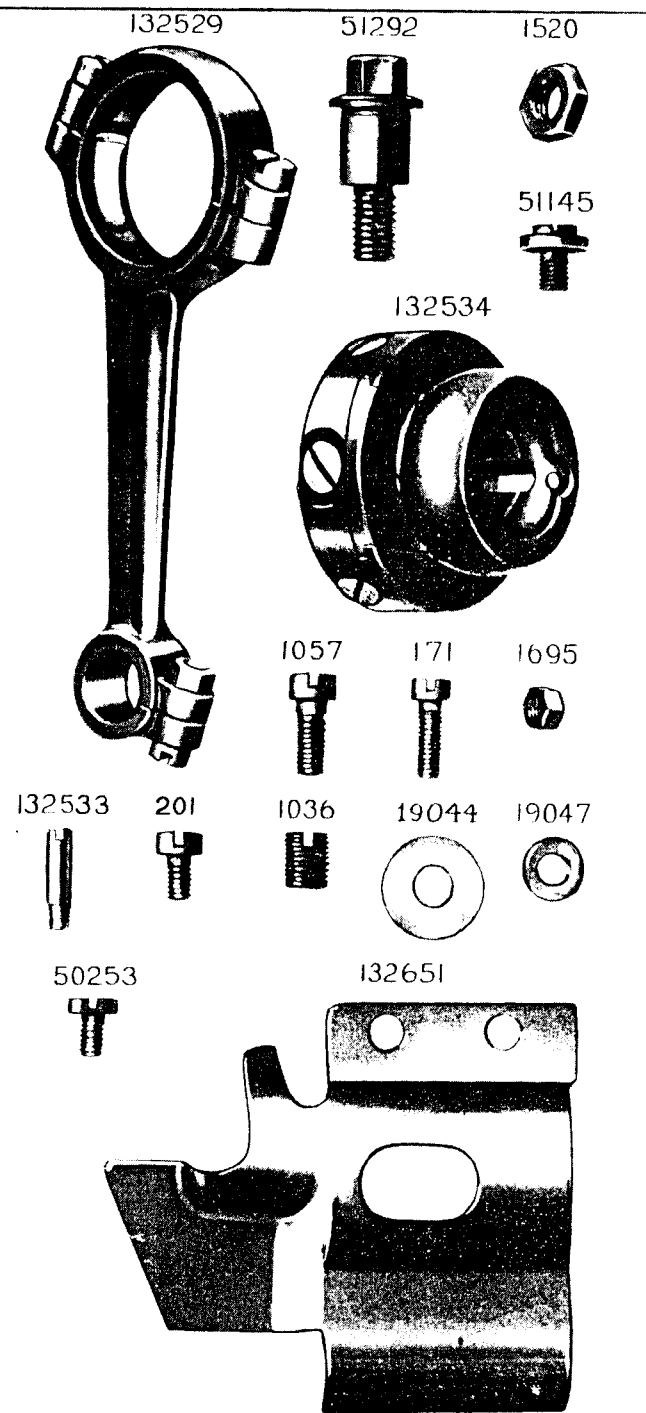


PLATE 7409—FULL SIZE

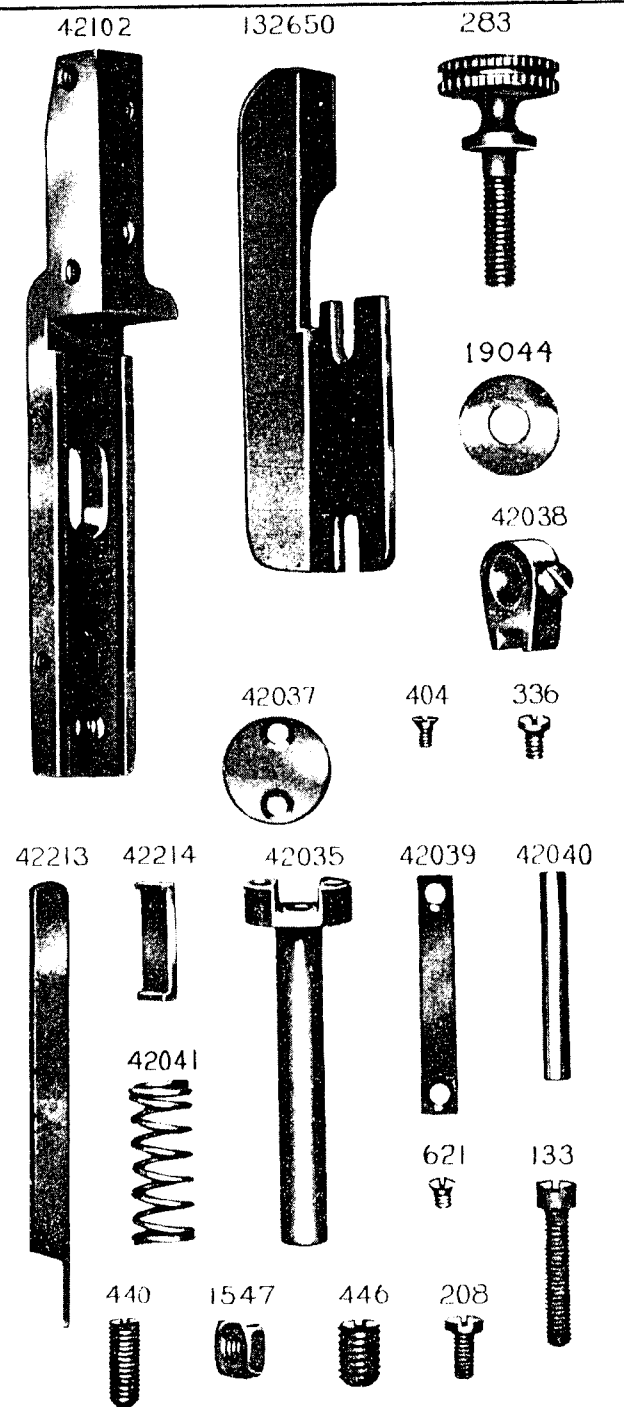


PLATE 7413—FULL SIZE

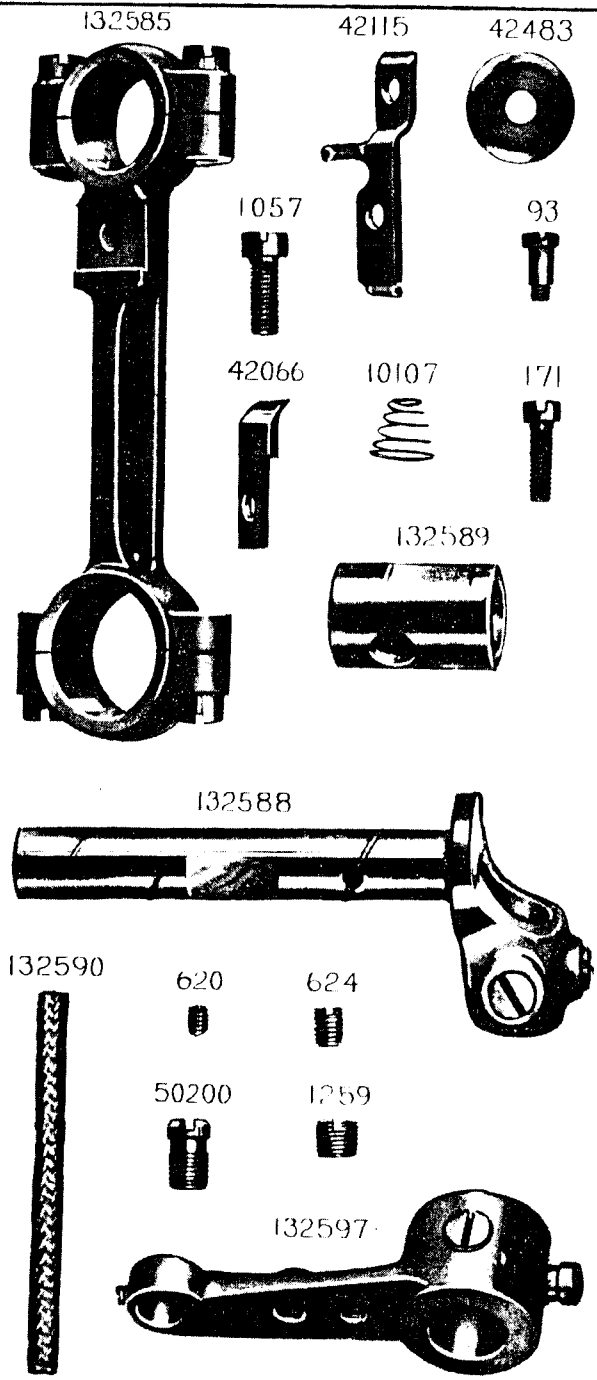


PLATE 7414—FULL SIZE

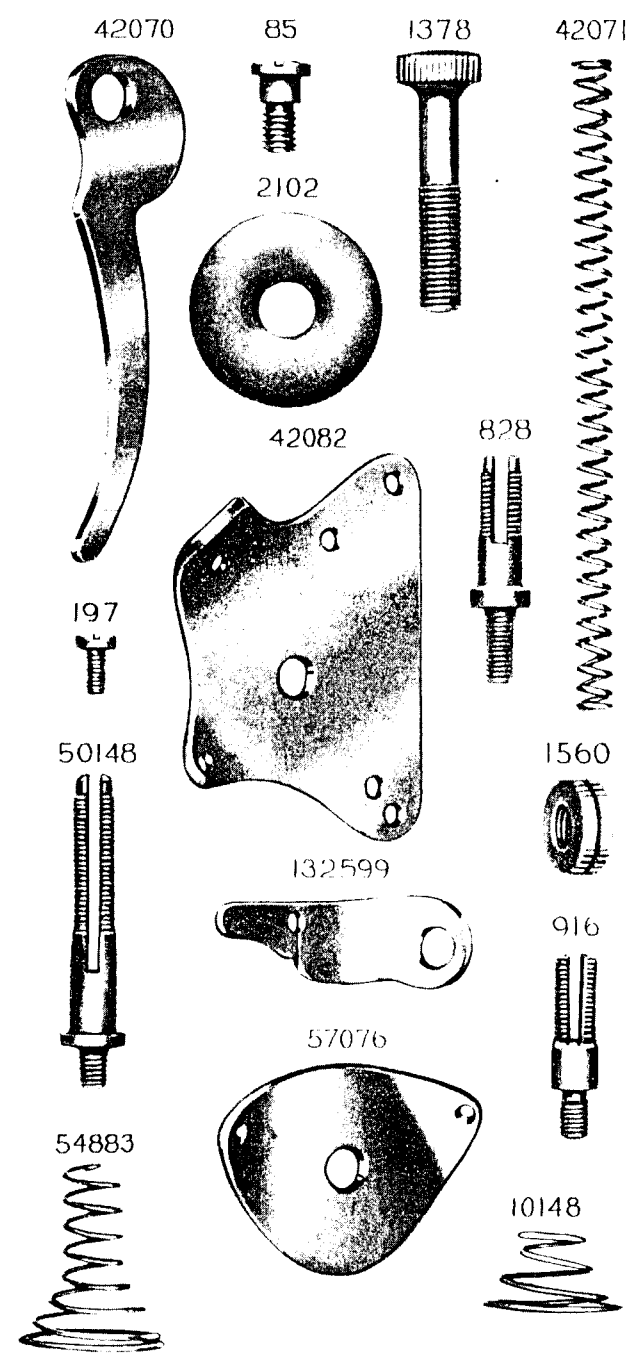


PLATE 7419—FULL SIZE

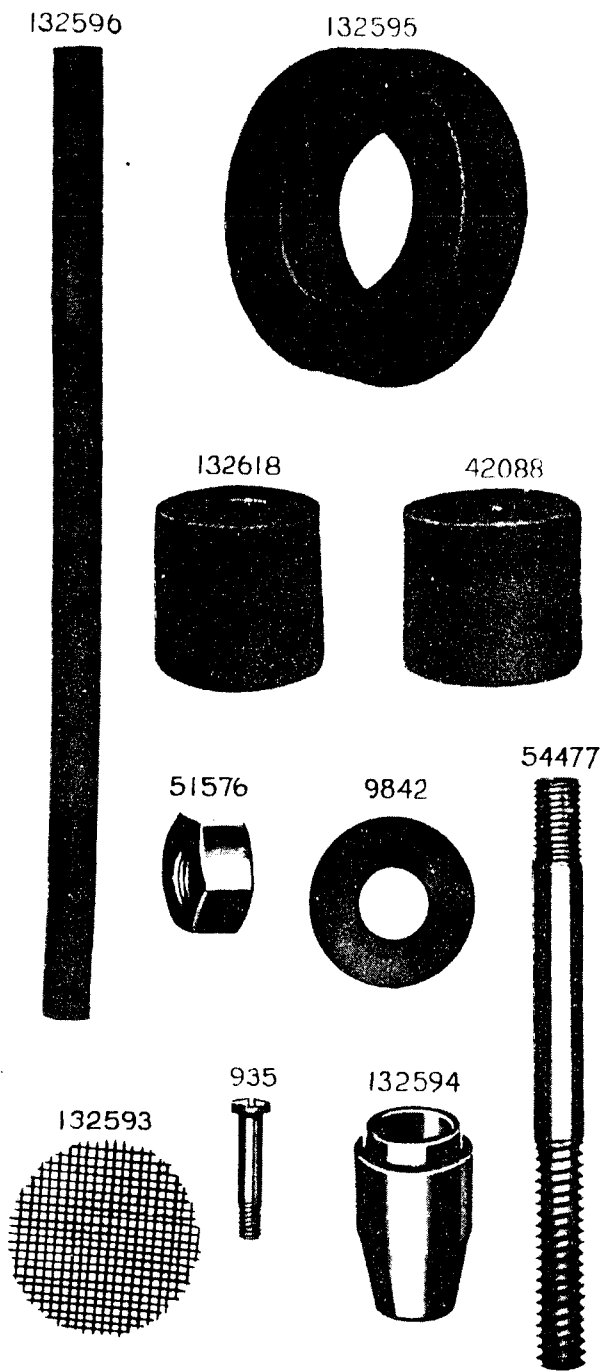


PLATE 20778—ONE-SIXTH SIZE

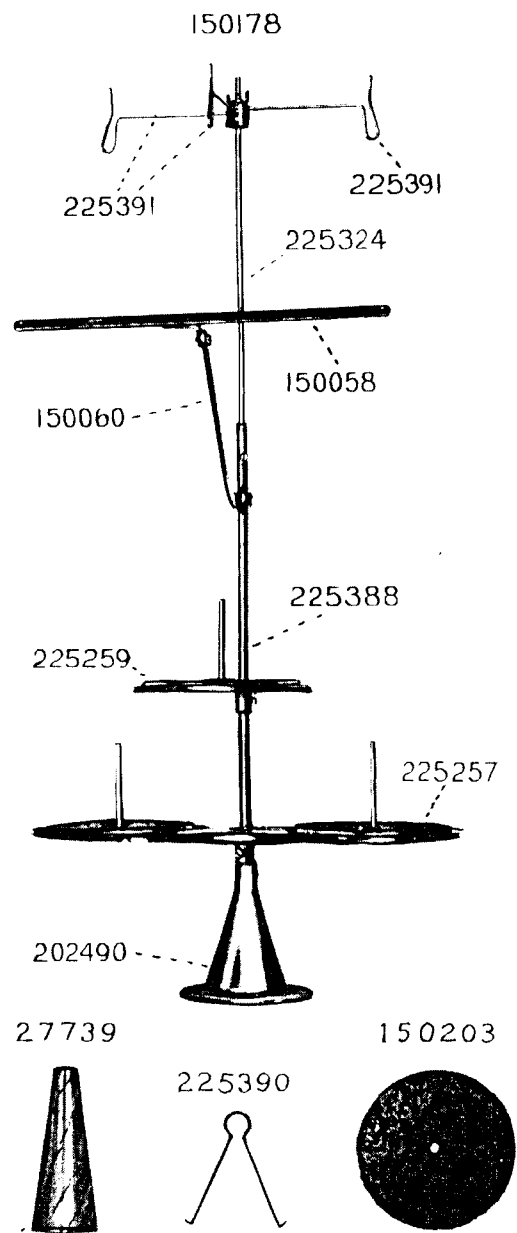
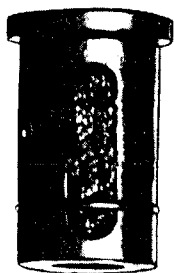


PLATE 20802-FULL SIZE

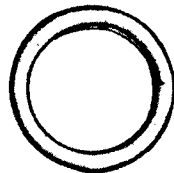
132714



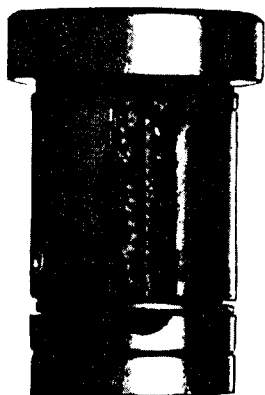
132556



132716



132694



132555



PLATE 20803-FULL SIZE

132542



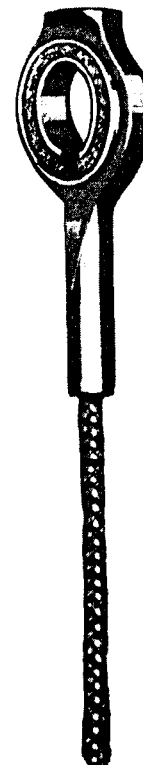
132544



132537



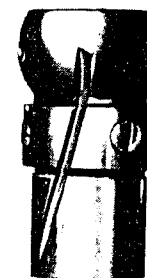
132785



132539



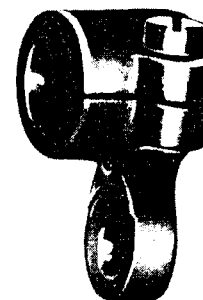
132649



462



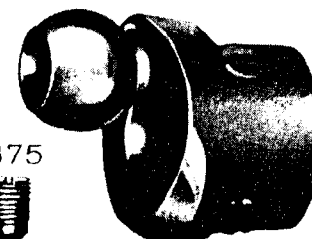
42021



157



132553



132543



1036



1375



PLATE 20804-FULL SIZE

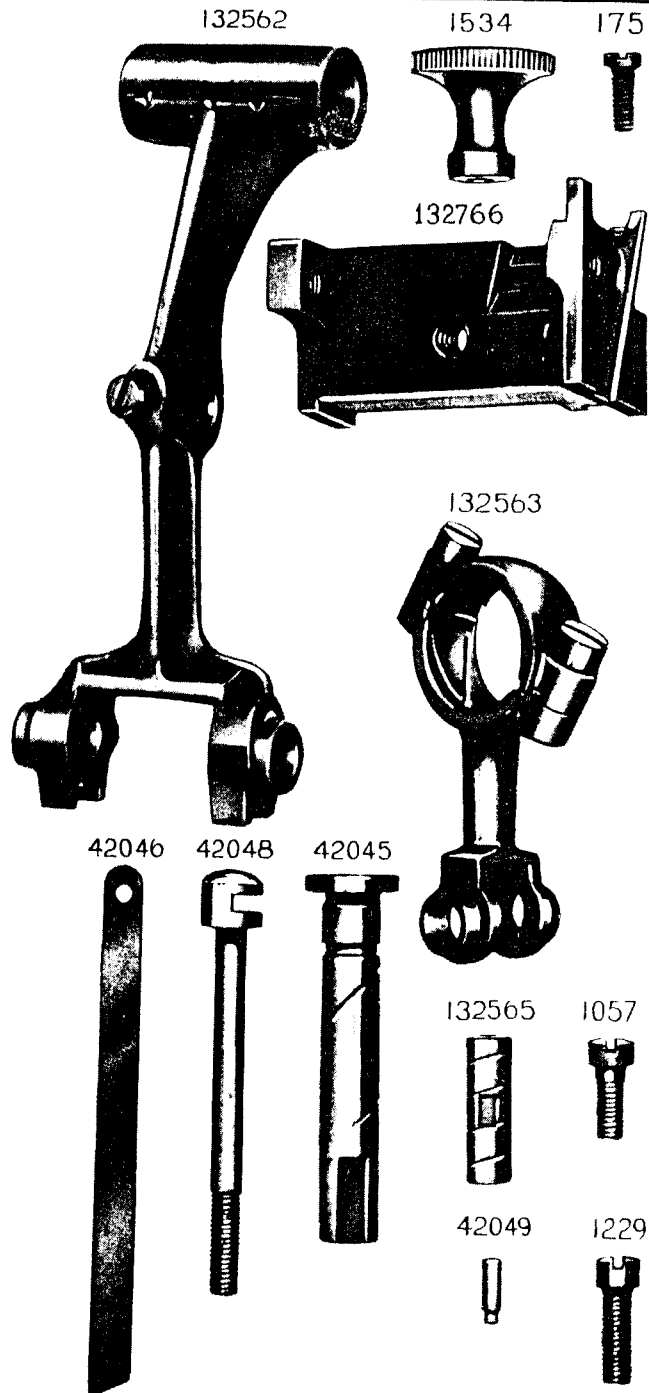


PLATE 20805-FULL SIZE

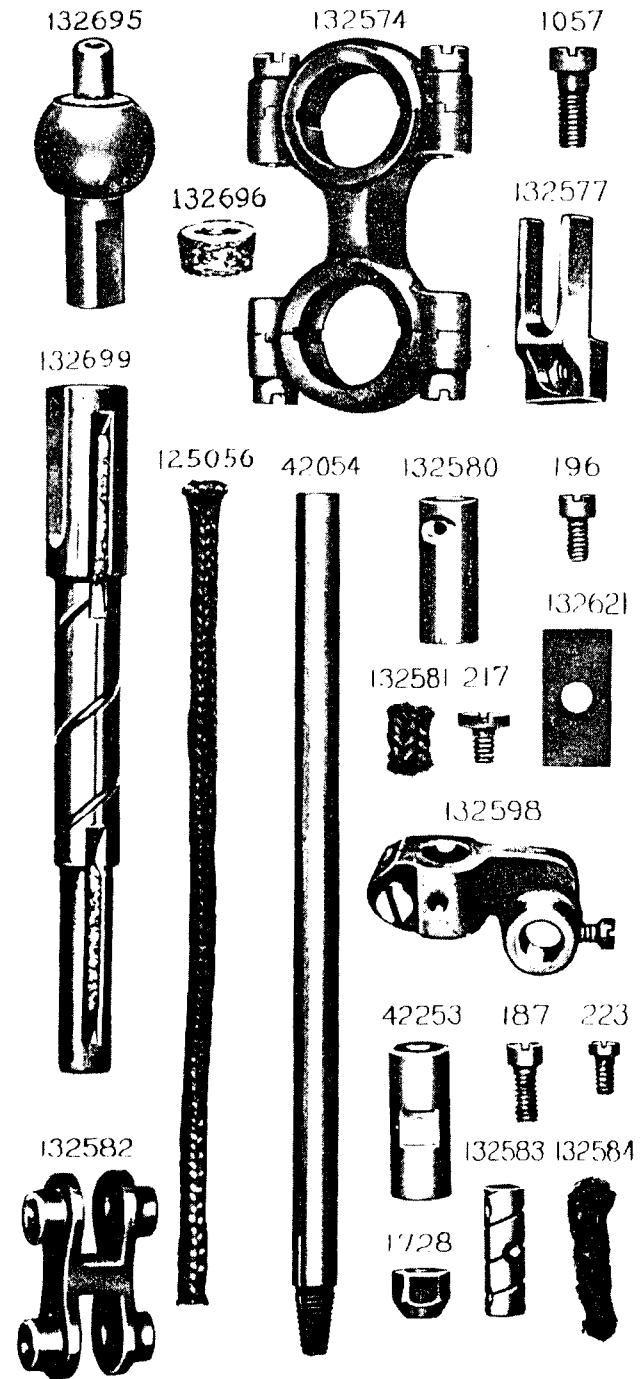


PLATE 20806-FULL SIZE

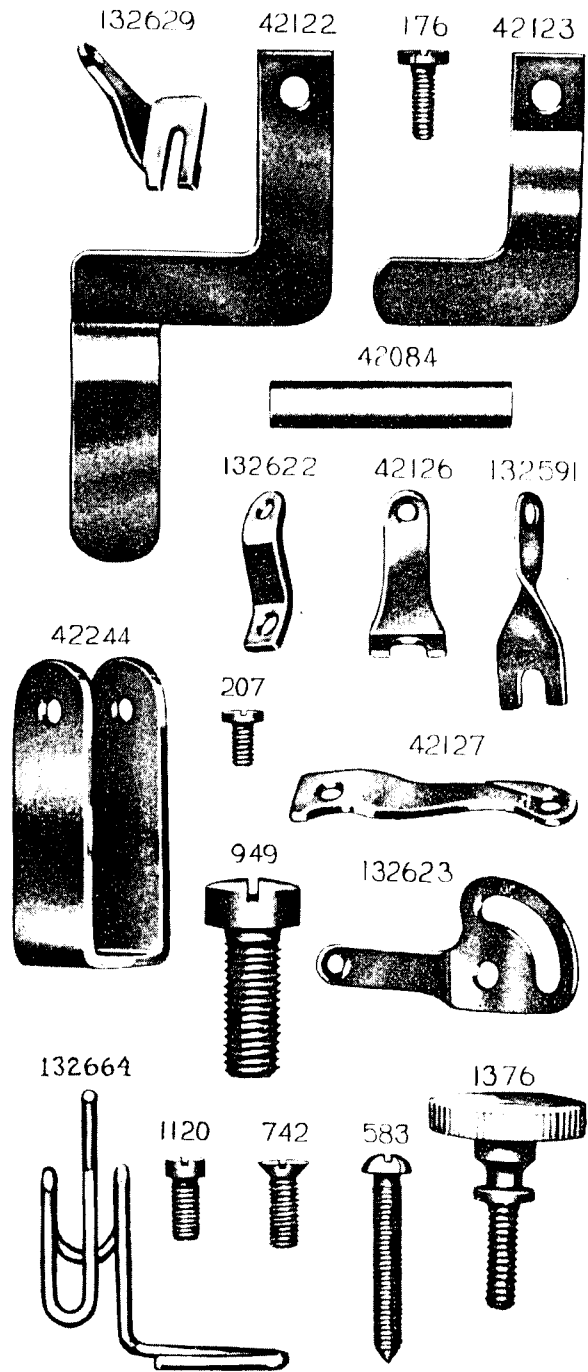


PLATE 20807-FULL SIZE

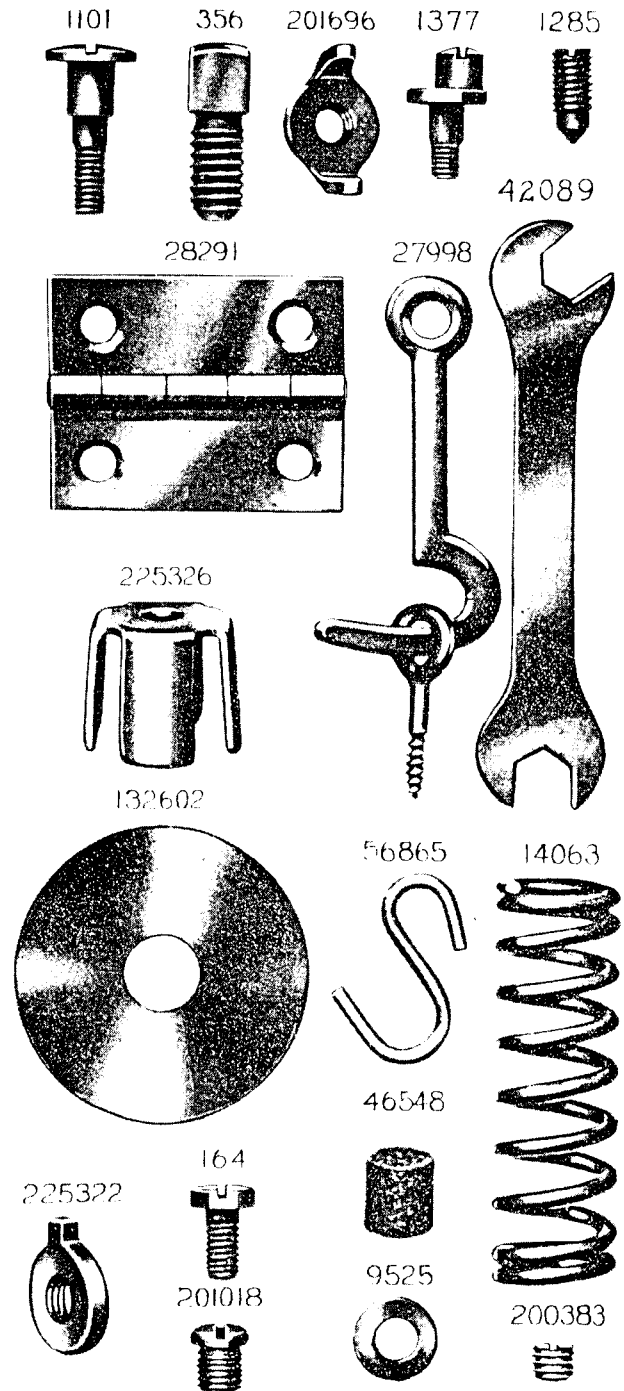


PLATE 20808-ONE-FOURTH SIZE

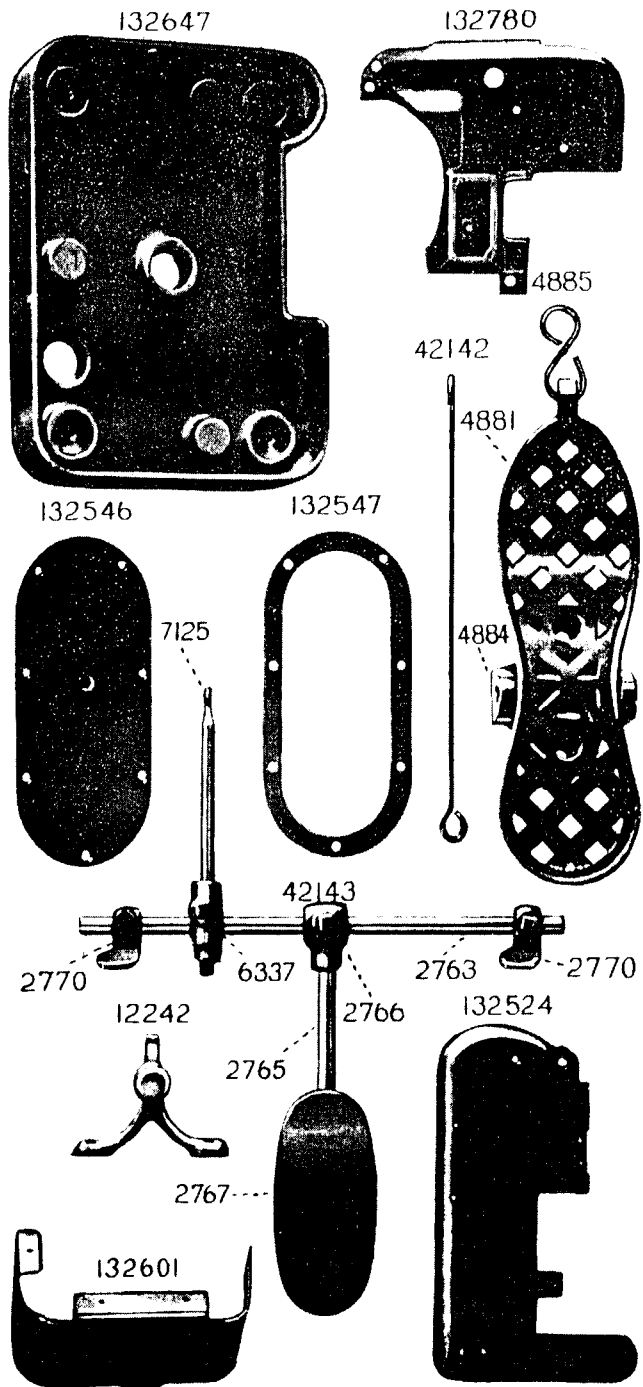


PLATE 20809-FULL SIZE

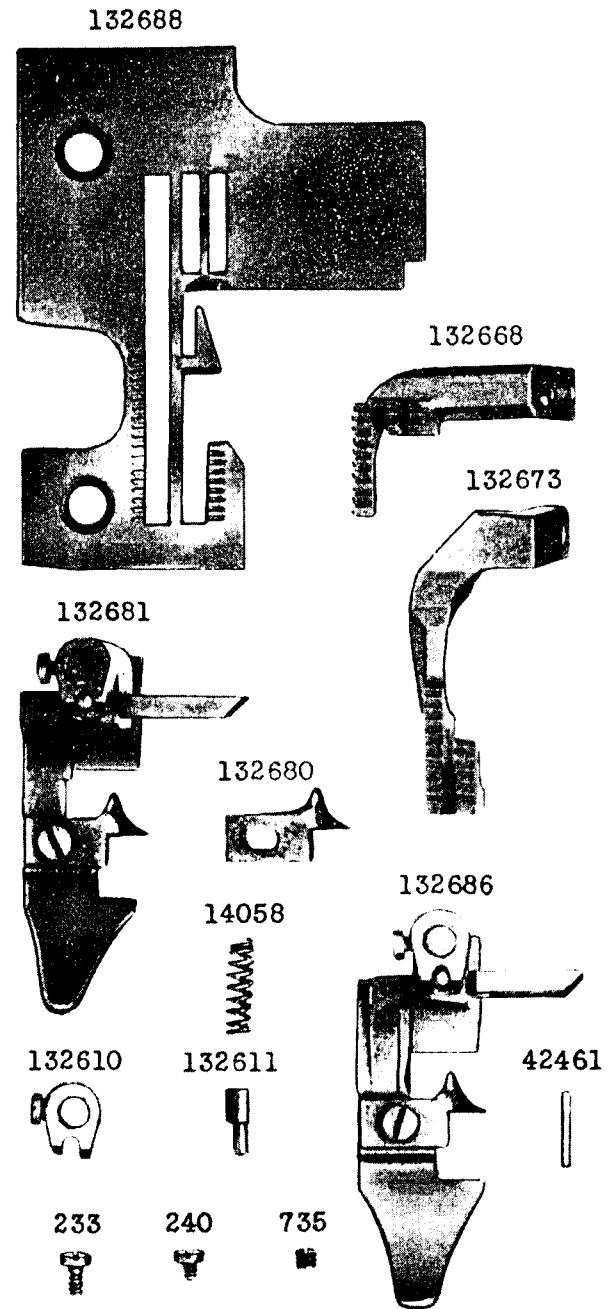
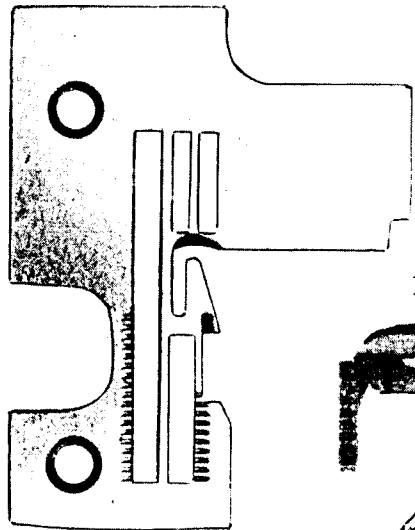
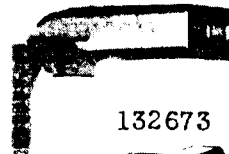


PLATE 20810-FULL SIZE

132689



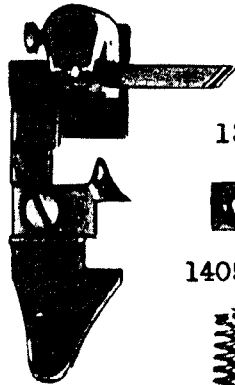
132668



132673



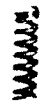
132681



132680



14058



132610



233



240



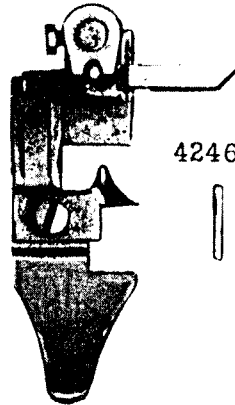
735



132611



132686

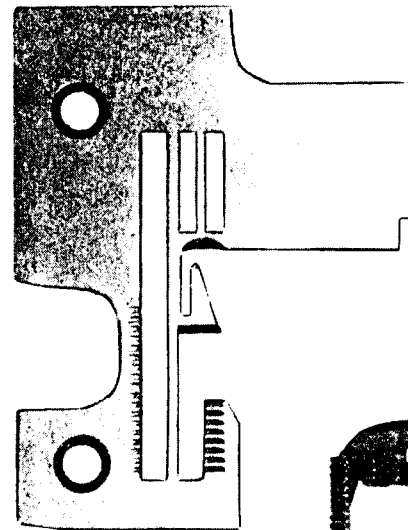


42461



PLATE 20811-FULL SIZE

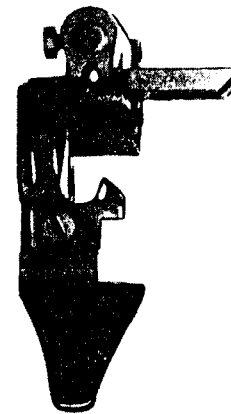
132690



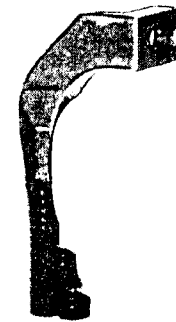
132669



132687



132674

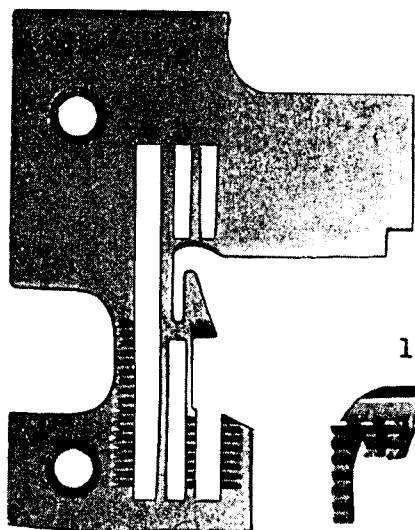


132682



PLATE 20812-FULL SIZE

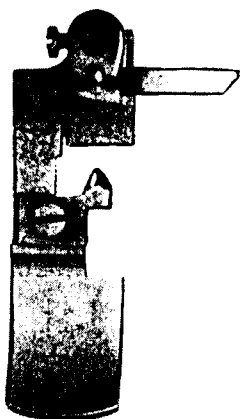
132765



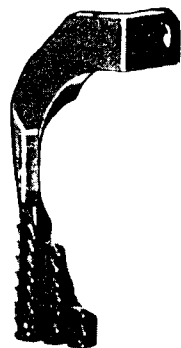
132761



132764



132762

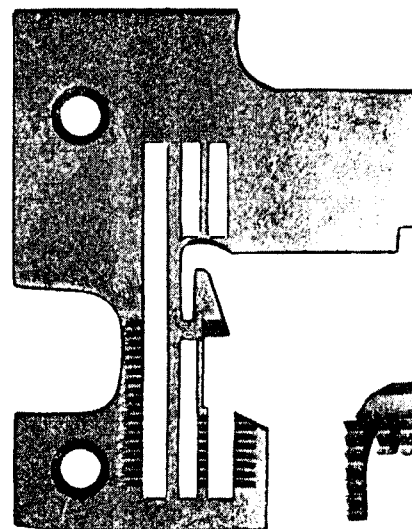


132682



PLATE 20813-FULL SIZE

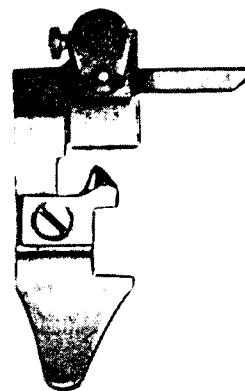
132765



132761



132768



132762

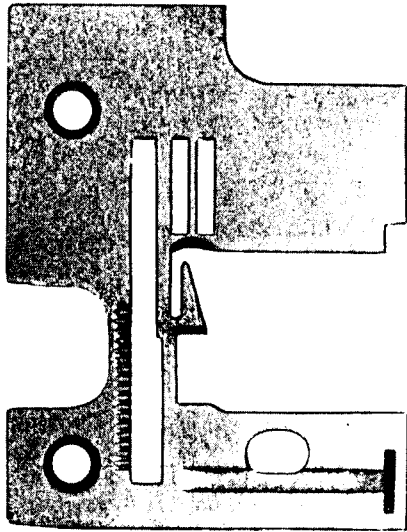


132682

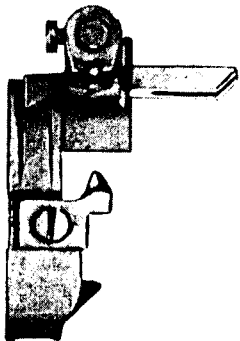


PLATE 20814-FULL SIZE

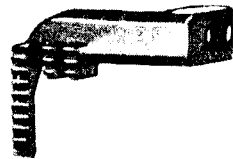
132709



132708



132668



132706

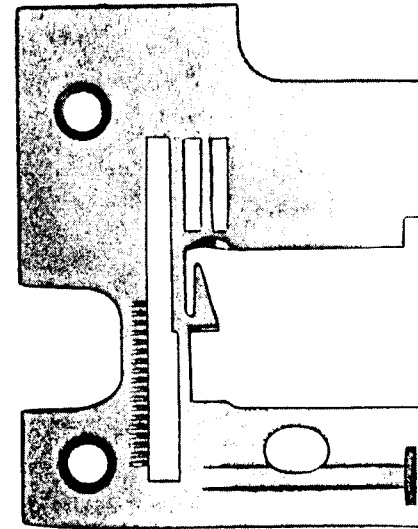


132682

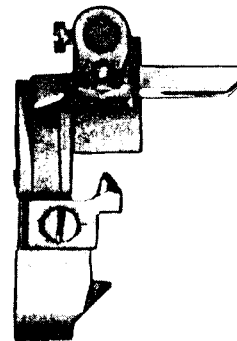


PLATE 20815-FULL SIZE

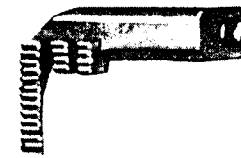
132723



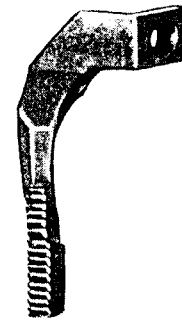
132708



132669



132722

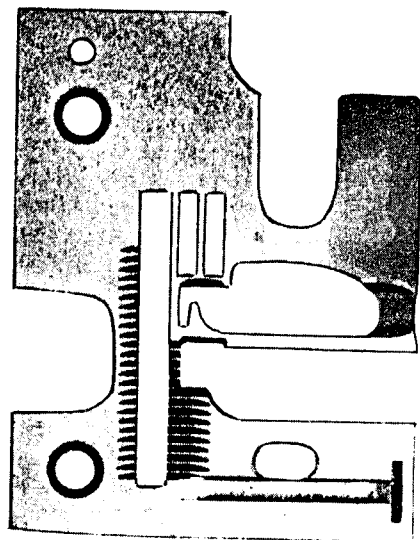


132682

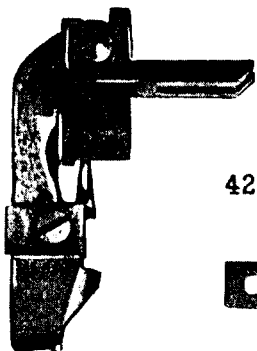


PLATE 20816-FULL SIZE

42452



42185



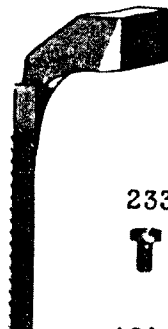
42149



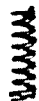
42184



42182



14058



9320



42160



233

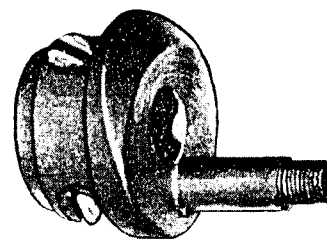


464



PLATE 20817-FULL SIZE

132769



1036



1375



132774



1664



132770



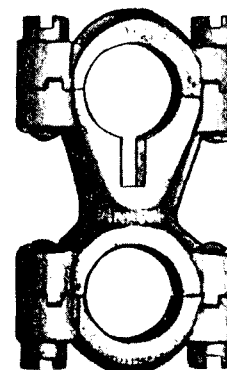
132771



132772



132777



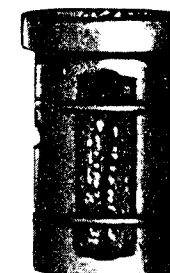
132802



896



132863



132715



132835

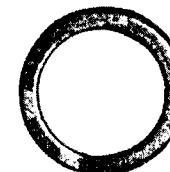


PLATE 20818-FULL SIZE

42305 42307 42040 42041



42306

42310

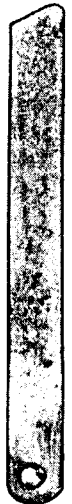


133

1534



42309



42039

42038

1101



440

336

621

42049

1547



1376

132767

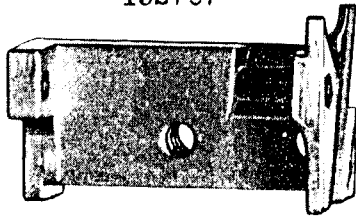
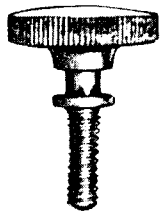
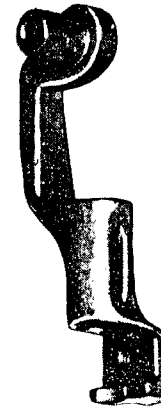


PLATE 20819-FULL SIZE

132665 132667 132666 1132

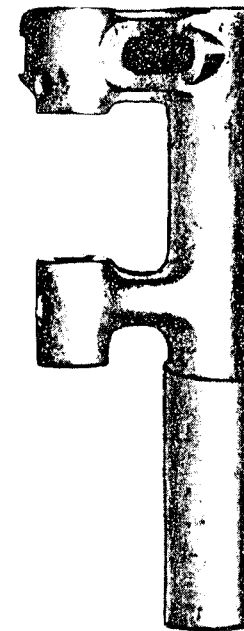


51360



132671

132675



132670

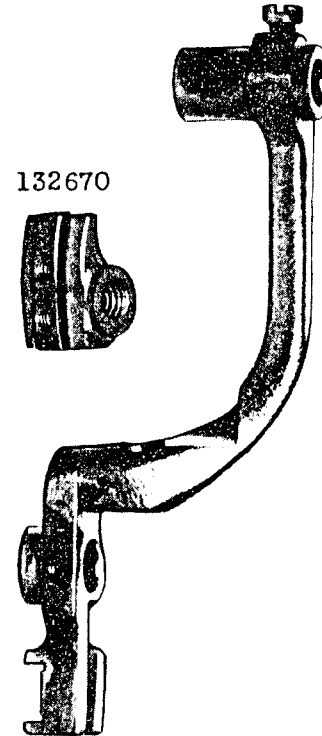
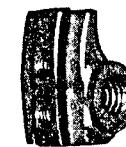


PLATE 20820-FULL SIZE

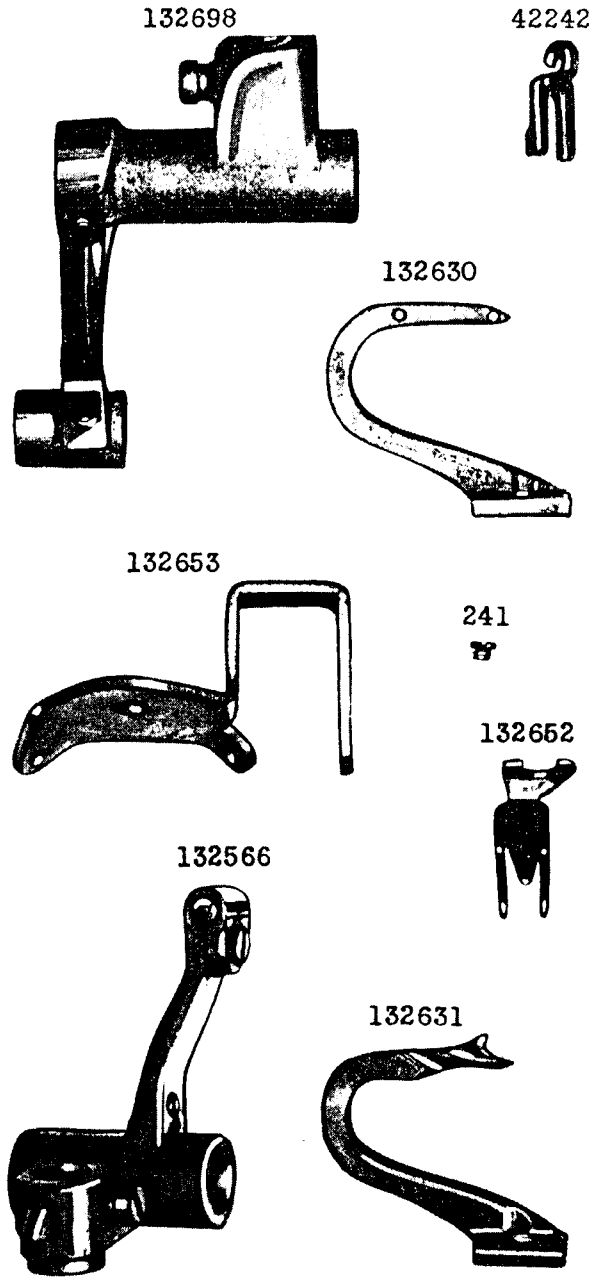


PLATE 20821-FULL SIZE

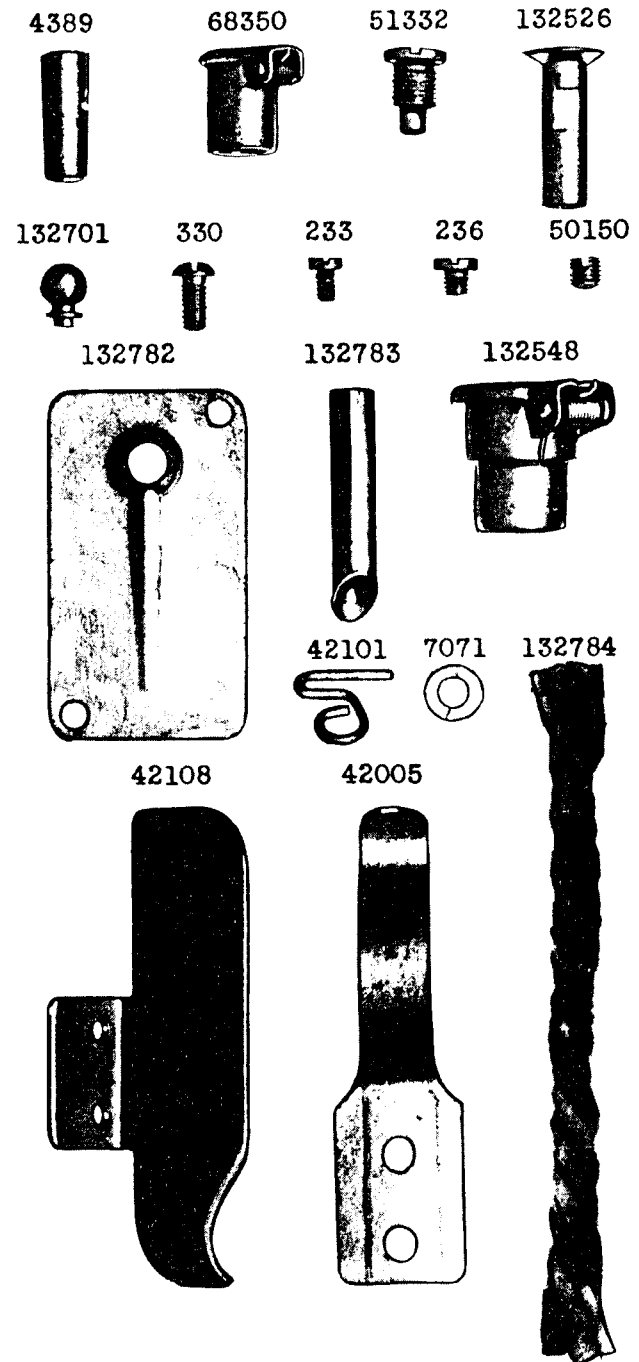
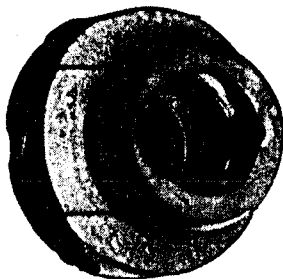


PLATE 20822-FULL SIZE

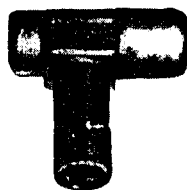
132644



132712



132718



42050



132719



50117 132721



132569



132552



68497



132720



PLATE 20823-FULL SIZE

132816



132817



132864 132868



132867



132558

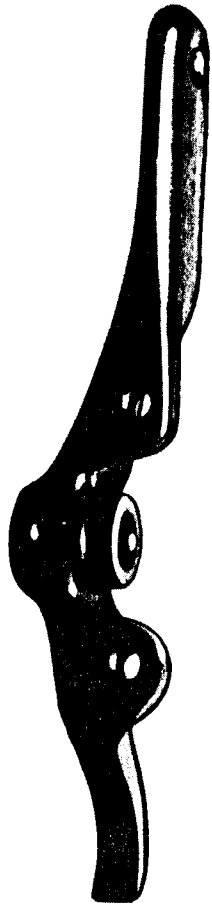


132559

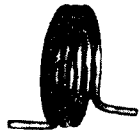


PLATE 20824-FULL SIZE

42130



42132



42131



1247



1301



131022



1148



1204



1324



39541



203



PLATE 20825-FULL SIZE

42188



42473

42478

42476



42475



42477



1117



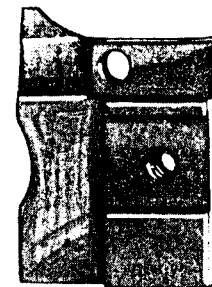
42474



190



132710



1209



22436



PLATE 20826-FULL SIZE

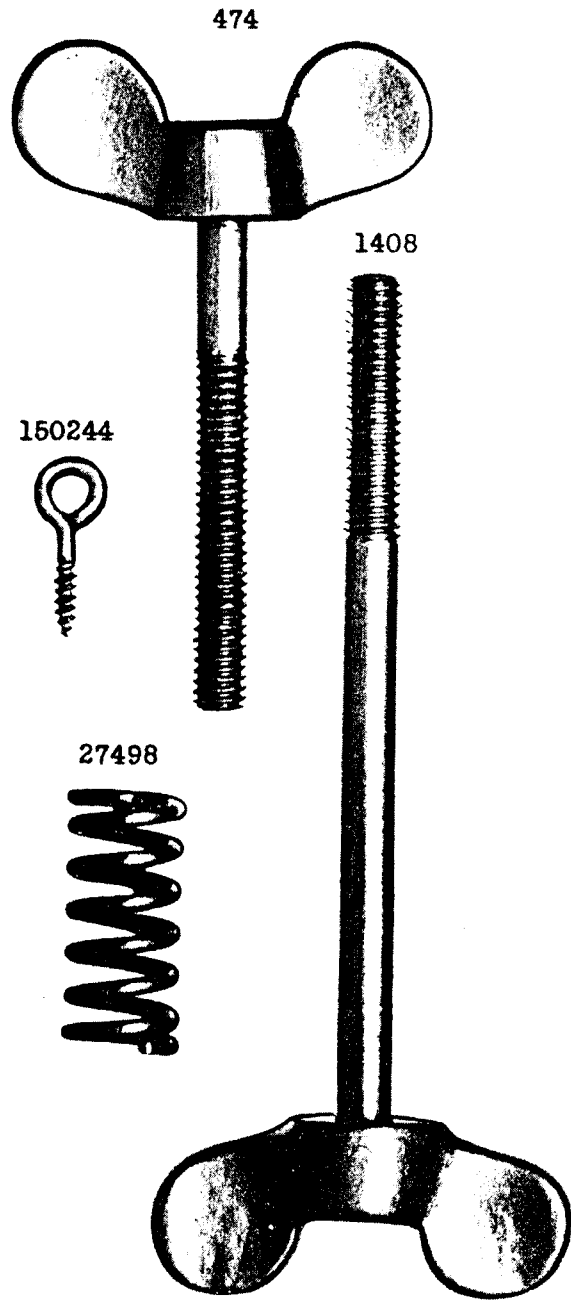


PLATE 20827-ONE-HALF SIZE

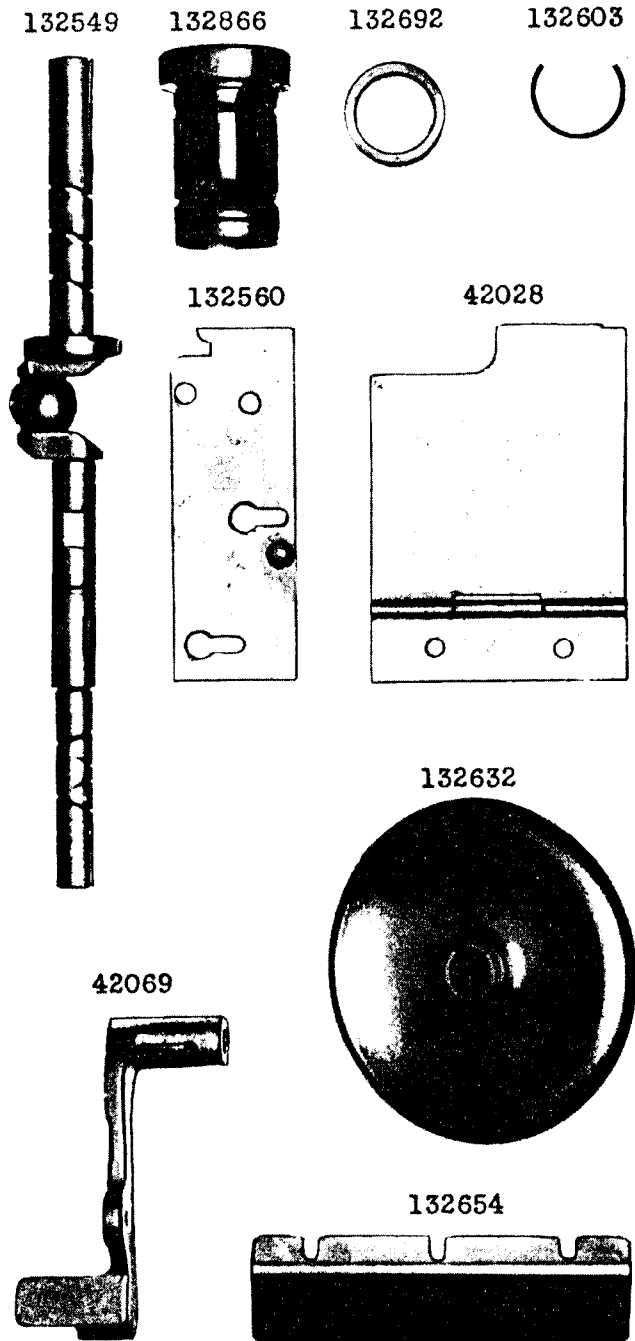
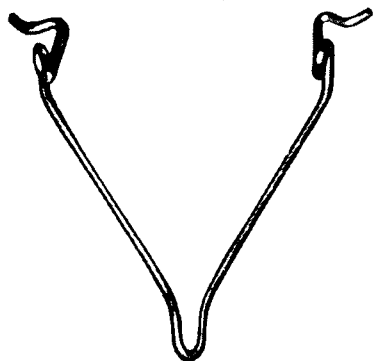


PLATE 20828-ONE-HALF SIZE

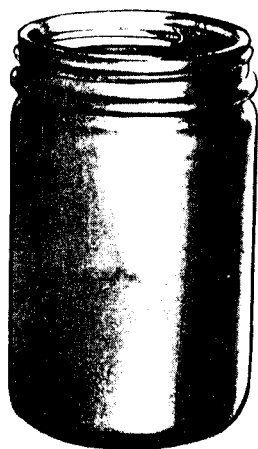
131189



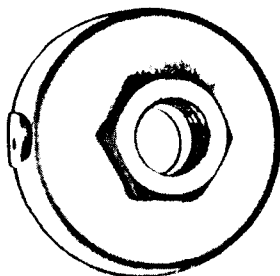
131265



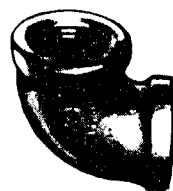
131185



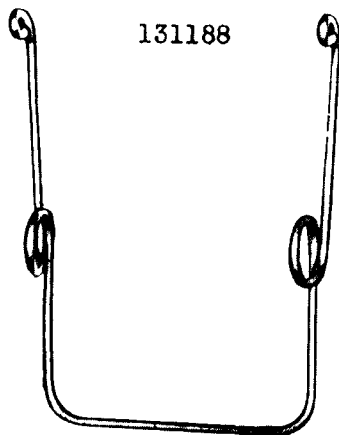
131191



131267



131188



131266



PLATE 20829-ONE-HALF SIZE

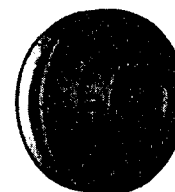
41327



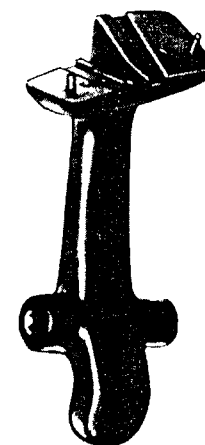
41326



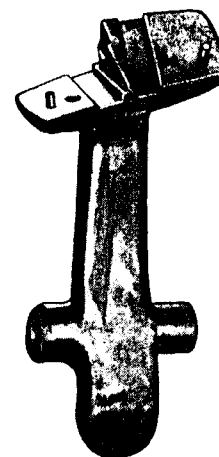
41328



41330



41818



41331

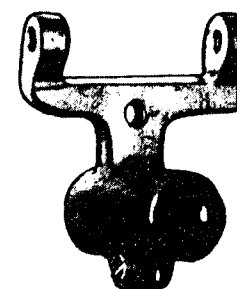
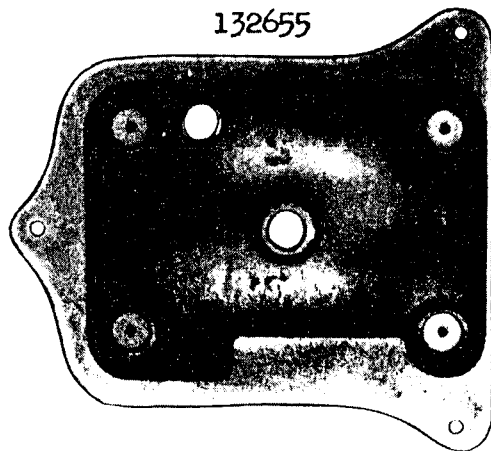


PLATE 20830-ONE-FOURTH SIZE

132655



41329

