

SINGER
61W16,W107

LIST OF PARTS



MACHINES Nos. 61w16 and 61w107

THE SINGER MANUFACTURING COMPANY

INDEX

	PAGE
ACCESSORIES	17
BINDERS	22
BOBBIN WINDER	17
FEED DOGS	20
KNEE LIFTER	18, 19
MACHINE No. 61w16	7
" " 61w107	16
NUMERICAL LIST OF PARTS	27
OBSOLETE PARTS	24
PRESSER FEET	20
RIBBON REELS	23
THROAT PLATES	21

Instructions for Ordering

In ordering from this list, use **ONLY** the **PART** number in the **FIRST** column.

The number stamped on a Sewing Machine Part is the number of the Single Part only, except when the part includes Set Screws, Clamping Screws, Studs and Rollers Spun on, Small Wires riveted, or Parts soldered together, etc., which it is necessary to furnish in combination.

Every combination of parts sent out has its specific number which, although not stamped on Parts (except in above cases) must be used when ordering the combination.

Each number always indicates the **SAME PART** in whatever list it appears, or for whatever Machine.

The letters after some of the numbers indicate the style of finish only, as follows:

- A. Hardened, Polished and Plated.
- B. Polished and Plated.
- C. Hardened only.
- D. Polished only.
- E. Soft, not polished.
- F. Hardened and Polished.
- H. Blued.

These letters **MUST BE USED** when they appear in the list and **AFTER** the number, as in the list.

In this series

200001 to 201500 are Screw Numbers.

201501 to 201800 are Nut Numbers.

201801 to 202000 are Roller Numbers.

202001 and upward are numbers of Machine Parts.

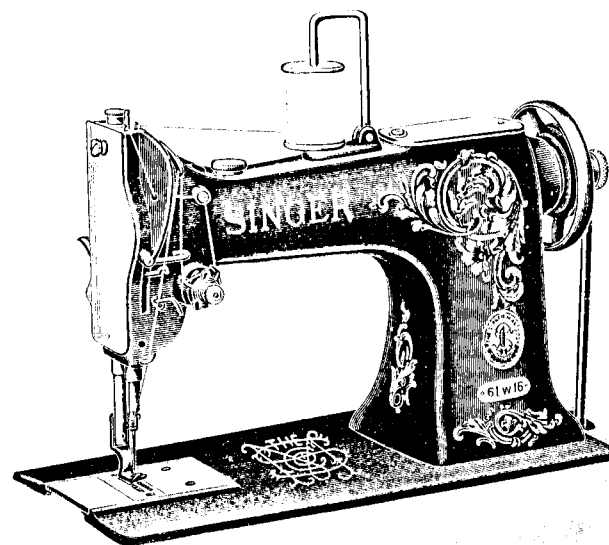
The figures in the second column refer only to the plate in which the illustration of the part is shown and are **NOT TO BE USED** in ordering.

Two or more numbers over a cut indicate that the difference between such parts is not visible in an illustration.

Parts marked with an asterisk (*) are furnished only when repairs are made at the factory.

LIST OF PARTS COMPLETE

FOR



MACHINE No. 61w16

HAS MECHANICAL OPENER

For Tailoring, Overalls, Canvas, Tennis Shoes, Etc.

No.	Plate	Name
*202242	---	Arm
202247	10667	" Cap
200278n	10244	" " Screw
202248	10244	" " " Washer
204235	10668	" Position Pin (2)
200010e	10245	" Screw (3)
202005	10245	" " Washer (3)
202249	13351	" Shaft with 200357e and 203100
202243	13364	" " Bushing (back) with
		202244
202244	---	Arm Shaft Bushing (back) Oil
		Packing (wick)
200338c	10244	Arm Shaft Bushing (back) Set
		Screw
202245	10667	Arm Shaft Bushing (front) with
		202036 and 202260

No.	Plate	Name
202260	—	Arm Shaft Bushing (front) Oil Packing (wick)
200502B	10246	Arm Shaft Bushing (front) Oil Packing Thumb Screw
202036	10668	Arm Shaft Bushing (front) Position Pin
200338c	10244	Arm Shaft Bushing (front) Set Screw
202530	13364	Arm Shaft Connection Belt
202252	10244	" " " " Pulley with 200327c, 200602E and two 202253
200602E	10244	Arm Shaft Connection Belt Pulley Position Screw
200327c	10244	Arm Shaft Connection Belt Pulley Set Screw
202253	10244	Arm Shaft Connection Belt Pulley Spring Flange
203100	—	Arm Shaft Oil Packing (wick)
200357E	10244	" " " " Stop Screw
202255	13364	Balance Wheel (belt groove 2 $\frac{3}{4}$ in. diam.) with 200328c and 200335c
200328c	10244	Balance Wheel Position Screw ...
200335c	10244	" " Set Screw
*202532	—	Bed with 202872
202258	12153	" Hinge Connection (2)
200570E	10245	" " " Screw (4)
206753	13364	" Plate (back)
200577H	10245	" " " Screw
210616	10667	" Slide (front)
202265	11671	Bobbin
207057	13363	" Case Base
206733	—	" " Cap with 200592c, 201016c and 206738
206734	13363	Bobbin Case Cap complete, Nos. 200964c, 206733, 206736 and 210736
206735	13363	Bobbin Case Latch
206736	—	" " " 206735 with 206731 and 206737
206731	13363	Bobbin Case Latch Fulcrum Pin ..
206737	13363	" " " Lever
210736	13363	" " " Spring
200964c	13363	" " " Stop Screw ...
206738	13363	" " Tension Spring
201016c	13363	" " " " Regulating Screw
200592c	13363	Bobbin Case Tension Spring Screw

No.	Plate	Name
207058	13363	Bobbin Case complete, Nos. 206734 and 207057
202500	10273	Bobbin Case Lever
202501	10273	" " " Bushing
200333c	10273	" " " " Set Screw
206764	13363	" " " Driving Eccentric with 200380c and 200444c..
206763	—	Bobbin Case Lever Driving Eccentric 206764 with 200583H and 206761
206728	13363	Bobbin Case Lever Driving Eccentric Connection
206729	—	Bobbin Case Lever Driving Eccentric Connection 206728 with 201194c, 201524c, 206758 and 206763
206730	13363	Bobbin Case Lever Driving Eccentric Connection Lever with 200086c
201194c	13363	Bobbin Case Lever Driving Eccentric Connection Lever Hinge Screw Stud
201524c	13363	Bobbin Case Lever Driving Eccentric Connection Lever Hinge Screw Stud Nut
206758	—	Bobbin Case Lever Driving Eccentric Connection Lever Oil Wick
200086c	10248	Bobbin Case Lever Driving Eccentric Connection Lever Pinch Screw
200380c	10272	Bobbin Case Lever Driving Eccentric Set Screw
200444c	10273	Bobbin Case Lever Driving Eccentric Spot Screw
206761	13363	Bobbin Case Lever Driving Eccentric Washer
200583H	10668	Bobbin Case Lever Driving Eccentric Washer Screw
207059	—	Bobbin Case Outfit complete, Nos. 200333c, 202500, 202501, 206729, 206730 and 207058
200459D	13353	Cloth Guide Thumb Screw
202274	10667	Face Plate
202135	10245	" " Position Pin
200462B	10245	" " Thumb Screw
202275	10667	Feed Bar
200641c	10246	" " Hinge Screw (driving)..
201522E	10246	" " " " Nut
202276	10245	" " Slide Block

No.	Plate	Name
202298	10245	Feed Bar Slide Block Crank with 200038c
203124	---	Feed Bar Slide Block Crank 202298 with 200205E, 201518E and 202276
200038c	10245	Feed Bar Slide Block Crank Pinch Screw
200205E	10245	Feed Bar Slide Block Hinge Screw
201518E	10245	" " " " " "
		Nut
202288	13367	Feed Dog
200106E	10245	" " Screw (2)
202297	10667	" Driving Connection with 200054E and 202277
202298	10245	Feed Driving Connection Crank with 200038c
200038c	10245	Feed Driving Connection Crank Pinch Screw
200545c	10245	Feed Driving Connection Hinge Screw
201518E	10245	Feed Driving Connection Hinge Screw Nut
202277	---	Feed Driving Connection Oil Packing (wick)
200054E	10246	Feed Driving Connection Pinch Screw
202300	10246	Feed Driving Eccentric Regulating Bracket
203134	---	Feed Driving Eccentric Regulating Bracket 202300 with 202252, two each 201014c and 201525E
201014c	10245	Feed Driving Eccentric Regulating Bracket Hinge Screw
201525E	10245	Feed Driving Eccentric Regulating Bracket Hinge Screw Nut
202301	10246	Feed Driving Eccentric Regulating Bracket Plunger
202595	10246	Feed Driving Eccentric Regulating Bracket Plunger Spring
200607c	10246	Feed Driving Eccentric Regulating Bracket Plunger Spring Stop Screw
201014c	10245	Feed Driving Eccentric Regulating Bracket Stop Screw
201525E	10245	Feed Driving Eccentric Regulating Bracket Stop Screw Nut
200429c	10246	Feed Driving Eccentric Regulating Screw
200383c	10246	Feed Driving Eccentric Regulating Screw Check Screw

No.	Plate	Name
202303	13352	Feed Driving Rock Shaft
206860	---	" " " " 202303 with 200641c, 201522E and 202275
202305	10245	Feed Driving Rock Shaft Center (2)
200043c	10246	Feed Driving Rock Shaft Center Set Screw (2)
202306	10667	Feed Lifting Connection with 200054E and 202277
202307	10246	Feed Lifting Connection Eccentric with 200382c and 200437c
200437c	10246	Feed Lifting Connection Eccentric Position Screw
200382c	13366	Feed Lifting Connection Eccentric Set Screw
200545c	10245	Feed Lifting Connection Hinge Screw
201518E	10245	Feed Lifting Connection Hinge Screw Nut
202277	---	Feed Lifting Connection Oil Packing (wick)
200054E	10246	Feed Lifting Connection Pinch Screw
202308	13352	Feed Lifting Rock Shaft
202305	10245	" " " " Center (2)
200043c	10246	" " " " " Set Screw (2)
207070	13352	Feed Regulating Spindle with 202311, 202443, 202619 and 210554
210554	10668	Feed Regulating Spindle Spring (flat)
*202311		Feed Regulating Spindle Head ...
202443	10244	" " " " Pin
202619	10668	" " " " " Position Pin
*206776		Hook (sewing)
206777	13352	" 206776 with 200145H, 200596E, 200614c, 202320, 203101, 206751, 206775 and 206852
207060	13361	Hook and Bobbin Case complete, Nos. 206777 and 207058
206852	13353	Hook Gib
200614c	11671	" " Hinge Screw
200596E	11671	" " Screw
203101	---	" Oil Wick
*202320	---	" Shaft, 11 7/8 in. long
202321	10245	" " Bushing (back)
200346c	10245	" " " " " Set Screw
202322	10245	" " " (front)
200346c	10245	" " " " " Set Screw..

No.	Plate	Name
202323	10244	Hook Shaft Connection Belt Pulley with 202324 and two 201018c ...
201018c	13353	Hook Shaft Connection Belt Pulley Set Screw
202324	10244	Hook Shaft Connection Belt Pulley Spring Flange
202260	—	Hook Shaft Oil Packing (wick) (2)
206775	11671	" " Pin
206751	11671	" Washer
200145H	11671	" " Screw
202445	10936	Knee Lifter Connection Lever with 202446
202786	—	Knee Lifter Connection Lever 202445 with 200224H, 200262H, 202447 and 202449
200224H	10248	Knee Lifter Connection Lever Hinge Screw
202447	10936	Knee Lifter Connection Lever Lifting Rod with 202302
202302	10248	Knee Lifter Connection Lever Lifting Rod Cotter Pin
202446	10246	Knee Lifter Connection Lever Pin
202449	10936	" " Lifting Lever
200262H	10248	" " " " Hinge Screw
202326	10248	Needle Bar with 200141F
202550	10283	" " Bushing
206880	—	" " " 202550 with 202326
200352c	10248	Needle Bar Bushing Set Screw ...
202552	10283	" " Connecting Link
202332	10668	" " " " Oil Guard
200161b	10247	Needle Bar Connecting Link Oil Guard Screw
202333	10248	Needle Bar Connecting Link Stud with 202254
202254	—	Needle Bar Connecting Link Stud Oil Packing (wick)
200374c	10668	Needle Bar Connecting Link Stud Set Screw
200383c	10246	Needle Bar Connecting Link Stud Set Screw
*206891	—	Needle Bar Connecting Stud
202329	10248	" " " " 206891 with 200086c and 202330
202330	—	Needle Bar Connecting Stud Oil Packing (wick)

No.	Plate	Name
200086c	10248	Needle Bar Connecting Stud Pinch Screw
202551	13364	Needle Bar Crank with 200335c, 200374c, 200383c, 200428c and 202333
203771	—	Needle Bar Crank 202551 with 202329, 202398 to 202400 and 202552
203172	10248	Needle Bar Crank Friction Washer
200428c	10248	" " " Position Screw...
200335c	10244	" " " Set Screw
200141F	10248	" Set Screw
202335	10667	Presser Bar (hollow) with 200074F
207072	10249	" " Bushing
200352c	10248	" " " Set Screw
202554	10283	" " Lifter
200653c	10249	" " " Hinge Screw ...
202553	10283	" " Lifting Releasing Lever Bracket
200260b	10249	Presser Bar Lifting Releasing Lever Bracket Guide Screw
202342	10249	Presser Bar Lifting Releasing Lever Bracket Spring (spiral)..
202337	10249	Presser Bar Position Guide
202338	10249	" " " " Lever with 200086F
200086F	10248	Presser Bar Position Guide Lever Pinch Screw
200352c	10248	Presser Bar Position Guide Set Screw
202378	13366	Presser Bar Spring (heavy)
202346	10249	" " " Stop Rod
200492b	10249	" " Thumb Screw (pressure regulating)
200475b	10668	Presser Bar Thumb Screw Thumb Set Screw
202355	10668	Presser Bar Thumb Screw Thumb Set Screw Packing (brass)
202090	13366	Presser Foot Hinge Pin
203011	—	" " Plate
202924	—	" " Shank
229867	13369	Presser Foot (hinged) complete, Nos. 202090, 202924 and 203011 ..
200074F	10249	Presser Foot Screw
226057	13366	Quilter Bracket with 200481b
200118c	13366	" " Screw
200481b	13366	" Thumb Screw
202068	12153	Spool Holder Base
200575H	10668	" " " Screw

No.	Plate	Name
204296	12153	Spool Holder Wire
200079H	10668	" " " Hinge Screw ...
204297	12153	Spool Holder complete, Nos. 200079H, 202068 and 204296
202397	10668	Take-up (auxiliary)
200842E	10668	" " Screw
202398	10247	" Lever
202399	10247	" " Driving Stud with 202277
202277	---	Take-up Lever Driving Stud Oil Packing (wick)
202400	10247	Take-up Lever Hinge Stud with 202423
202423	---	Take-up Lever Hinge Stud Oil Packing (wick)
200383C	10246	Take-up Lever Hinge Stud Set Screw
202401	10247	Take-up Lever Oiling Felt
200132E	10247	" " " " Screw
202402	10247	Tension Disc (back)
202403	10247	" " (front)
202404	10247	" Release Plunger
202405	10247	" " Washer
202407	10881	" Spring
200625F	10247	" Stud with 204925
200084F	---	" " Set Screw
204925	10668	" " Washer
201572B	10881	" Thumb Nut
202409	10252	Tension complete, Nos. 200625F, 201572B, 202402, 202403, 202405, 202407 and 202410
202410	10252	Thread Controller Spring
202411	10252	" " " Stop
200132E	10247	" " " " Screw
202413	10252	" Guide
202414	10252	" "
202415	10252	" "
202417	10252	" "
200582H	10252	" " Screw
200355H	10272	" " Set Screw
200368H	10668	" " " "
202091	10252	" Retainer Sleeve
202092	10252	" " Spring
204058	10252	" " Stud
200368H	10668	" " " Set Screw
204059	10668	Thread Retainer complete, Nos. 202091, 202092 and 204058

No.	Plate	Name
202826	13368	Throat Plate, 46 elongated needle hole, for needle sizes 20 and 22, with 202534, 202619 and two 200583H
202534	10668	Throat Plate Bobbin Case Stop ..
202619	10668	" " " " " Po- sition Pin
200583H	10668	Throat Plate Bobbin Case Stop Screw
202872	10668	Throat Plate Position Pin
200577H	10245	" " Screw (2)

MACHINE No. 61w107

HAS MECHANICAL OPENER

For Tailoring, Overalls, Canvas, Tennis Shoes, Etc.

This Machine is the same as No. 61w16 with the following exceptions:

No.	Plate	Name
*202241	----	Arm, in place of 202242
202250	13365	" Shaft with 200357E and 203100, in place of 202249
*206897	----	Bed with 202872, in place of 202532
202304	13365	Feed Driving Rock Shaft, in place of 202303
203122	----	Feed Driving Rock Shaft 202304 with 200641c, 201522E and 202275, in place of 206860
202654	13365	Feed Lifting Rock Shaft, in place of 202308
206754	13365	Hook 206776 with 200145n, 200596E, 200614c, 202319, 203101, 206751, 206775 and 206852, in place of 206777
207061	13365	Hook and Bobbin Case complete, Nos. 206754 and 207058, in place of 207060
*202319	----	Hook Shaft, 13 $\frac{1}{2}$ in. long, in place of 202320
202732	----	Knee Lifter Connection Lever 202445 with 200224n, 200262n, 202447 and 202448, in place of 202786
202448	10936	Knee Lifter Lifting Lever (long), in place of 202449

ACCESSORIES

No.	Plate	Name
200157E	13353	Attachment Screw
202265	11671	Bobbin (5)
*225482	----	" Case Screw Driver Blade ...
*225483	----	" " " " Handle ...
225497	12153	Bobbin Case Screw Driver complete, Nos. 225482 and 225483 ...
231337	13353	Cloth Guide
226056	13366	Quilter
135 x 5	----	Needles, three each, sizes 16 and 18
225180	----	Drip Pan (short) with four wood screws $\frac{1}{2}$ in., No. 5
41400	12153	Machine Rest Pin (wood)
36578	12153	Oiler with 36579
36579	12153	" Spout, 3 $\frac{1}{2}$ in. long, with 120417
120417	----	" " Washer
*225484	----	Screw Driver Blade
*225485	----	" " Handle
225498	12153	Screw Driver complete (7 $\frac{1}{2}$ in. long), Nos. 225484 and 225485 ...
225554	12153	Wrench (steel)

BOBBIN WINDER

Swing Automatic, Right Hand.

*225451	----	Bobbin Holder
225453	10882	Frame with 202277 and 225438 ...
225454	10882	" Hinge Pin
202277	----	" Oil Packing (wick)
225438	10882	" " Well Cap
225455	10882	" Spring
225456	10882	" " Plunger
202473	10883	Pulley with 200380c
200380c	10272	" Set Screw
*225443	----	Spindle
225452	10882	" 225443 with 225451
225444	10882	Stop Latch
200056E	10882	" " Screw
225458	10882	" " Thumb Lever
225459	10882	" " " " Hinge Stud
225460	10882	" " " " Joint Stud
202478	10882	" " Trip Lever
200299n	10882	" " " " Hinge Screw
225461	10881	Tension Bracket with 201499B ...
200082b	10881	" " Screw

No.	Plate	Name
202104	10881	Tension Bracket Screw Washer ...
2102	10881	" Disc
202407	10881	" Spring
201499B	10881	" Stud
201572B	10881	" " Thumb Nut
225462	10881	Bobbin Winder Tension Bracket complete. Nos. 201572B, 202407, 225461 and two 2102
225463	10883	Bobbin Winder and Tension Bracket Base
225436	10883	Universal Bobbin Winder complete, Nos. 200056F, 200082D, 200299U, 202104, 202473, 202478, 225444, 225452 to 225456, 225458 to 225460, 225462, 225463 and two wood screws $\frac{3}{4}$ in., No. 13, R.H.B.

KNEE LIFTER

227781	10936	Knee Lifter Rock Lever with 200522c and 200529c
227782	---	Knee Lifter Rock Lever 227781 with two each 202451 and 202452
227783	---	Knee Lifter Rock Lever 227782 with 202985 and 227784
202453	10936	Knee Lifter Rock Lever Knee Plate with 200526c
202985	---	Knee Lifter Rock Lever Knee Plate 202453 with 202455
202455	10936	Knee Lifter Rock Lever Knee Plate Arm (short)
200522c	13353	Knee Lifter Rock Lever Knee Plate Arm Set Screw
200526c	13353	Knee Lifter Rock Lever Knee Plate Set Screw
202451	10936	Knee Lifter Rock Lever Lug with two wood screws $\frac{3}{8}$ in., No. 13H
202452	13353	Knee Lifter Rock Lever Lug Hinge Pin
227784	10936	Knee Lifter Rock Lever Rod, 3 in. long, with 227785
*227785	---	Knee Lifter Rock Lever Rod Cap or Oil Guard
200529c	13353	Knee Lifter Rock Lever Rod Set Screw

(Other Knee Lifter Parts are listed with parts of machine head).

FOR MACHINE NO. 61w107

No.	Plate	Name
Same as for No. 61w16 with the following exceptions:		
225191	---	Drip Pan (long) with four wood screws $\frac{1}{2}$ in., No. 5, in place of 225180

KNEE LIFTER

227781	10936	Knee Lifter Rock Lever with 200522c and 200529c
227782	---	Knee Lifter Rock Lever 227781 with two each 202451 and 202452
227787	---	Knee Lifter Rock Lever 227782 with 202203 and 227784
202453	10936	Knee Lifter Rock Lever Knee Plate with 200526c
202203	---	Knee Lifter Rock Lever Knee Plate 202453 with 202454
202454	10936	Knee Lifter Rock Lever Knee Plate Arm (long)
200522c	13353	Knee Lifter Rock Lever Knee Plate Arm Set Screw
200526c	13353	Knee Lifter Rock Lever Knee Plate Set Screw
202451	10936	Knee Lifter Rock Lever Lug with two wood screws $\frac{3}{8}$ in., No. 13H
202452	13353	Knee Lifter Rock Lever Lug Hinge Pin
227784	10936	Knee Lifter Rock Lever Rod, 3 in. long, with 227785
*227785	---	Knee Lifter Rock Lever Rod Cap or Oil Guard
200529c	13353	Knee Lifter Rock Lever Rod Set Screw

(Other Knee Lifter Parts are listed with parts of machine head).

FEED DOGS

No.	Plate	Name
202284	13367	Feed Dog, for 202812
202286	13367	" " " 202821
202288	13367	" " " 202823, 202826 and 203193
226171	13367	Feed Dog, for 226175 and 226190 ..
230598	13367	" " " 203102

PRESSER FEET

203767	10921	Presser Foot with 202108, for clamping tailoring guide
206830	13369	Presser Foot
206832	13369	" "
207024	13369	" " for binding cardigan jackets
202379	10921	Presser Foot Guide
202392	10921	" " " (auxiliary foot)
202393	10921	" " " for thick goods
202394	10921	" " " " tucks
202395	10921	" " "
202396	10921	" " " at left, for tucks
202808	10921	" " " Clamp
202799	10921	" " " " Hinge Pin
202763	10921	" " " " " Spring
202108	10921	" " " " " " "
		Pin
203768	10921	Presser Foot complete, Nos. 202379, 202392 to 202396, 202763, 202799, 202808 and 203767, for tailoring
206998	13369	Presser Foot Holder with 200543H, for Presser Bar 202335 as a sub- stitute for Compound Presser Bar 202514
200543H	13369	Presser Foot Screw
206842	---	" " Cleft Holder, for Hemmers

THROAT PLATES

No.	Plate	Name
202812	13368	Throat Plate, 46 needle hole, for needle sizes 16 and 18, with 202534, 202619 and two 200583H, for 202284
202821	13368	Throat Plate, 50 needle hole, for needle sizes 14 and 15, with 202534, 202619 and two 200582H, for 202286
202823	13368	Throat Plate, 50 needle hole, for needle sizes 14 and 15, with 202534, 202619 and two 200583H, for overall and tailoring work, for 202288
202826	13368	Throat Plate, 46 elongated needle hole, for needle sizes 20 and 22, with 202534, 202619 and two 200583H, for 202288
203102	13368	Throat Plate, 50 needle hole, for needle sizes 14 and 15, with 202534, 202619 and two 200583H, for mattress binding and similar work, for 230598
203193	13368	Throat Plate, 40 needle hole, for needle sizes 20 and 22, with 202534, 202619 and two 200583H, for 202288
226190	13367	Throat Plate, 50 needle hole, for needle sizes 14 and 15, with 202534, 202619 and two 200583H, for 226171 and 226175
200582H	10252	Throat Plate Bobbin Case Stop Screw

BINDERS

BINDER

For Skirts

No.	Plate	Name
225636	13366	Bias Binder on Shank, folds binding of the following widths: $\frac{5}{8}$, $\frac{3}{4}$, $\frac{7}{8}$, $1\frac{1}{8}$, $1\frac{1}{4}$ and 1 inch

Note: Specify width wanted on order.

ENGLISH BINDER

For Binding Cardigan Jackets with Elastic or Bias Braid.

226171	13367	Feed Dog
226172	13366	Binder Head, for tapes or folded strips $\frac{1}{8}$, $\frac{1}{4}$, $\frac{3}{8}$, $\frac{1}{2}$, $\frac{5}{8}$, $\frac{3}{4}$ and $\frac{7}{8}$ inch

Note: State width required, send samples of material to be folded and sufficient material to test Binder.

200896B	13366	Binder Thumb Screw
226173	13370	Binder complete, Nos. 226172, 230650 and two 200896B
230650	13370	Binder Plate with two 226174 and seven 225648
200577H	10245	Binder Plate Screw
225648	13366	" Tape Tension Pin
226174	13366	" " " " (guard) ..
226175	—	Binder complete, Nos. 200577H, 226171, 226173 and 226190
207024	13369	Presser Foot
226190	13367	Throat Plate, 50 needle hole, for needle sizes 14 and 15, with 202534, 202619 and two 200583H

RIBBON REELS

No.	Plate	Name
226200	—	Ribbon Reel (6 in. diam.) with 225666 and three 205520
226211	—	Ribbon Reel (holding projection $6\frac{3}{4}$ in. diam.) with 226212 and 226213
225663	13365	Ribbon Reel (9 in. diam.) with 225666 and three 205520
226212	13366	Ribbon Reel Center Pin
226213	13366	" " " " Washer .
225664	13366	" " Supporting Spindle
225665	—	" " " "
		Base with 225664 and two wood screws $\frac{3}{8}$ in., No. 7
230471	—	Ribbon Reel Supporting Spindle Hub
225666	—	Ribbon Reel Supporting Spindle Hub 230471 with 225980
225980	—	Ribbon Reel Supporting Spindle Hub Base
205520	13366	Ribbon Reel Supporting Spindle Hub Base Rivet
226201	—	Ribbon Reel (6 in. diam.) complete, Nos. 225665 and 226200
225976	—	Ribbon Reel (9 in. diam.) complete, Nos. 225663 and 225665

OBSOLETE PARTS

No.	Plate	Name
*202967	--	Bobbin Case
202267	11671	" " Latch
*202056	----	" " " Pin
202269	11671	" " " Plunger
202270	11671	" " " Spring
202716	11671	" " Tension Spring
202796	10273	Bobbin Case complete, Nos. 200594e, 200984e, 202056, 202267, 202269, 202270, 202716 and 202967
202502	10273	Bobbin Case Lever Driving Cam with 200380c and 200444c
202503	10273	Bobbin Case Lever Driving Cam Lever with 200086c
202504	10273	Bobbin Case Lever Driving Cam Lever Spring (spiral)
206760	13363	Bobbin Case Lever Driving Eccentric Connection
206762	----	Bobbin Case Lever Driving Eccentric Connection 206760 with 206763
206759	13363	Bobbin Case Lever Driving Eccentric Connection Lever with 200086c and 206758
202841	10273	Bobbin Case Lever complete, Nos. 202500 to 202504
202505	----	Bobbin Case Outfit complete, Nos. 200333c, 202796 and 202841
202470	10271	Bobbin Winder Base
202471	10271	" " Frame
202472	10271	" " " Spring
202474	10271	" " Spindle
202475	10272	" " Stop Latch
202477	10272	" " " " Thumb Lever
202479	10271	Bobbin Winder complete, Nos. 200056e, 200161b, 200221b, 201537u, 202470 to 202475, 202477, 202478, three 200299u and two round head wood screws 1 in., No. 13
202480	10271	Bobbin Winder Spool Holder Base with 200355u and 202484
202481	10271	Bobbin Winder Spool Holder Base Spool Pin

No.	Plate	Name
202482	10272	Bobbin Winder Spool Holder Tension Disc (lower or upper)
202483	10272	Bobbin Winder Spool Holder Tension Disc Spring (brass)
202484	10272	Bobbin Winder Spool Holder Tension Disc Thread Guide
202485	10271	Bobbin Winder Spool Holder complete, Nos. 200011e, 202480, 202481, 202483, two 202482 and one wood screw 1 in., No. 13 ..
202064	13363	Hook Shaft Pin
206780	13353	" Washer

PLATE 10244—FULL SIZE

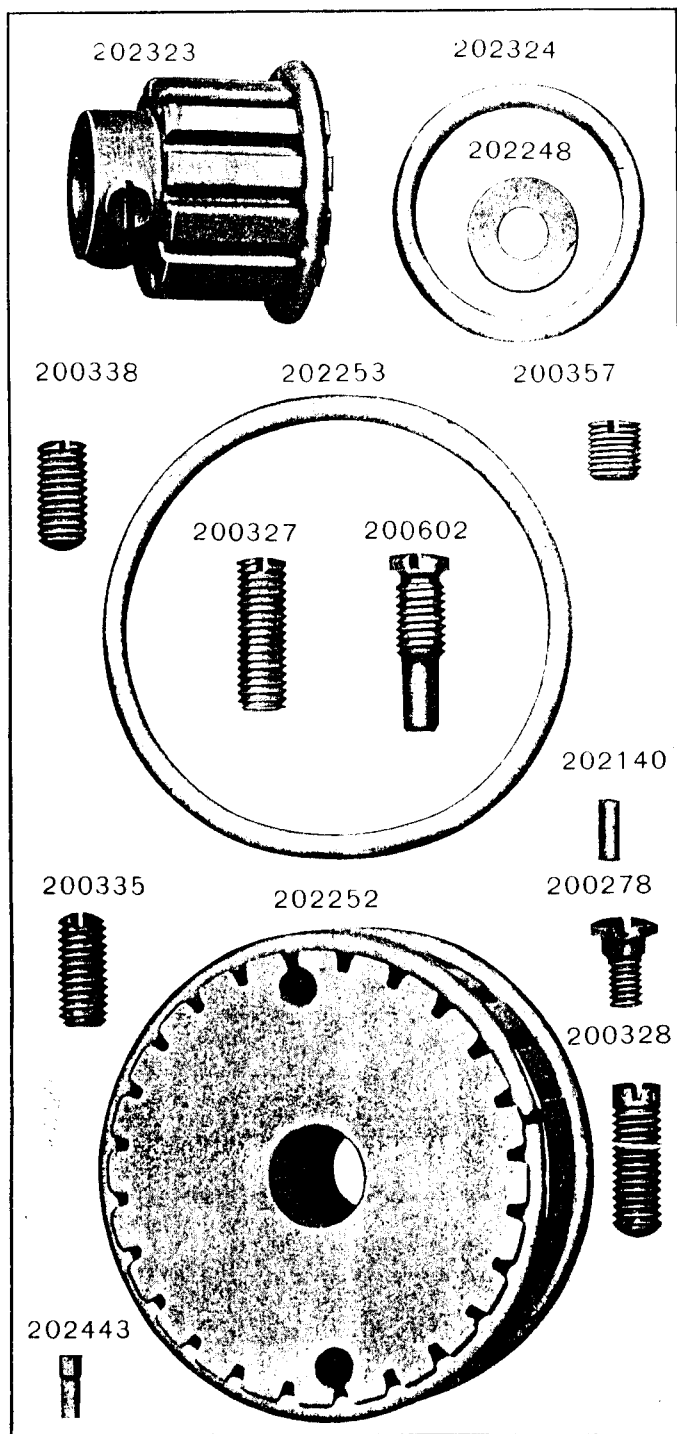


PLATE 10245—FULL SIZE

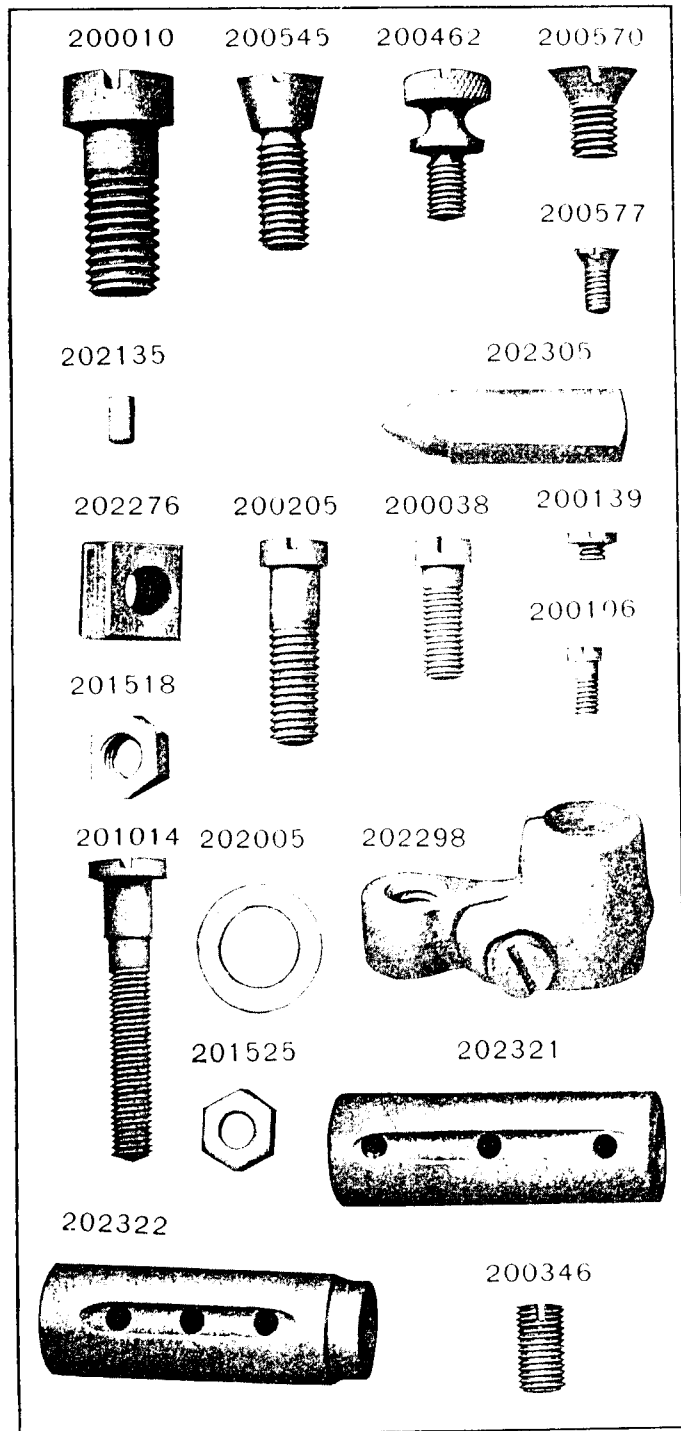


PLATE 10246—FULL SIZE

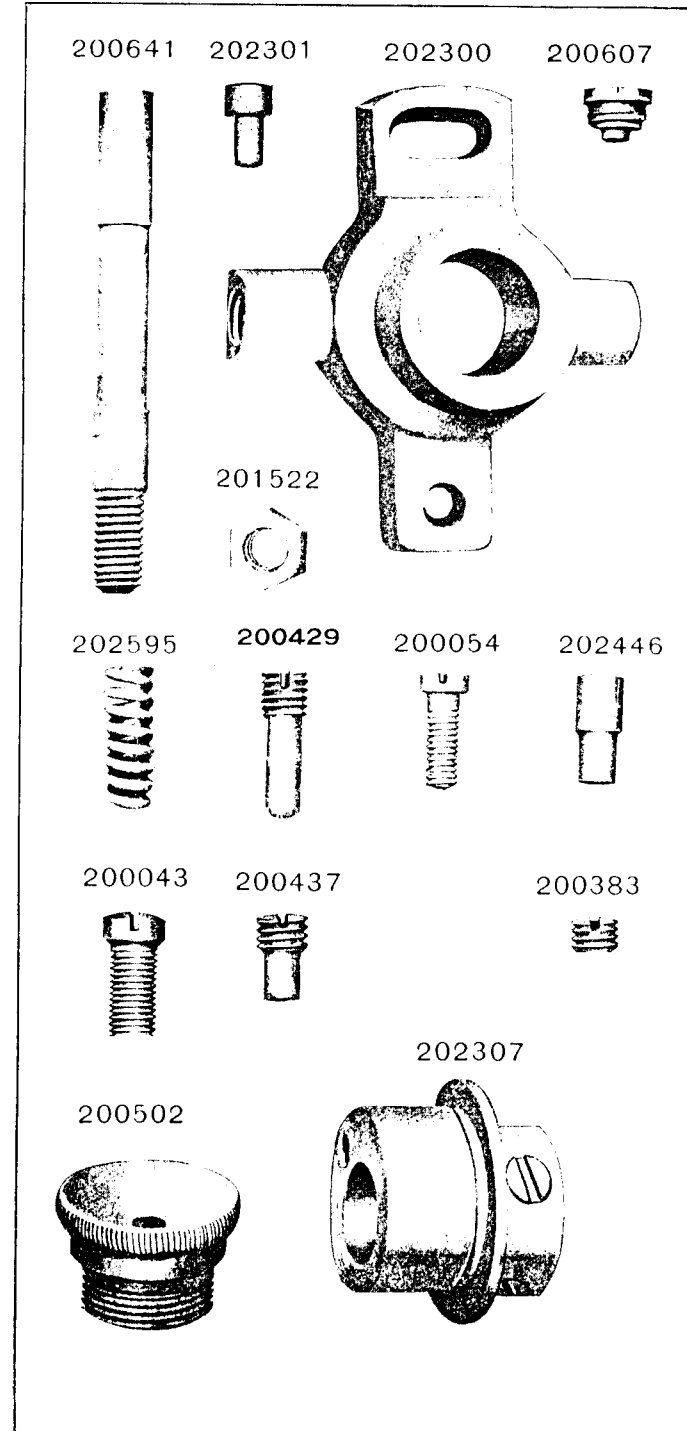


PLATE 10247—FULL SIZE

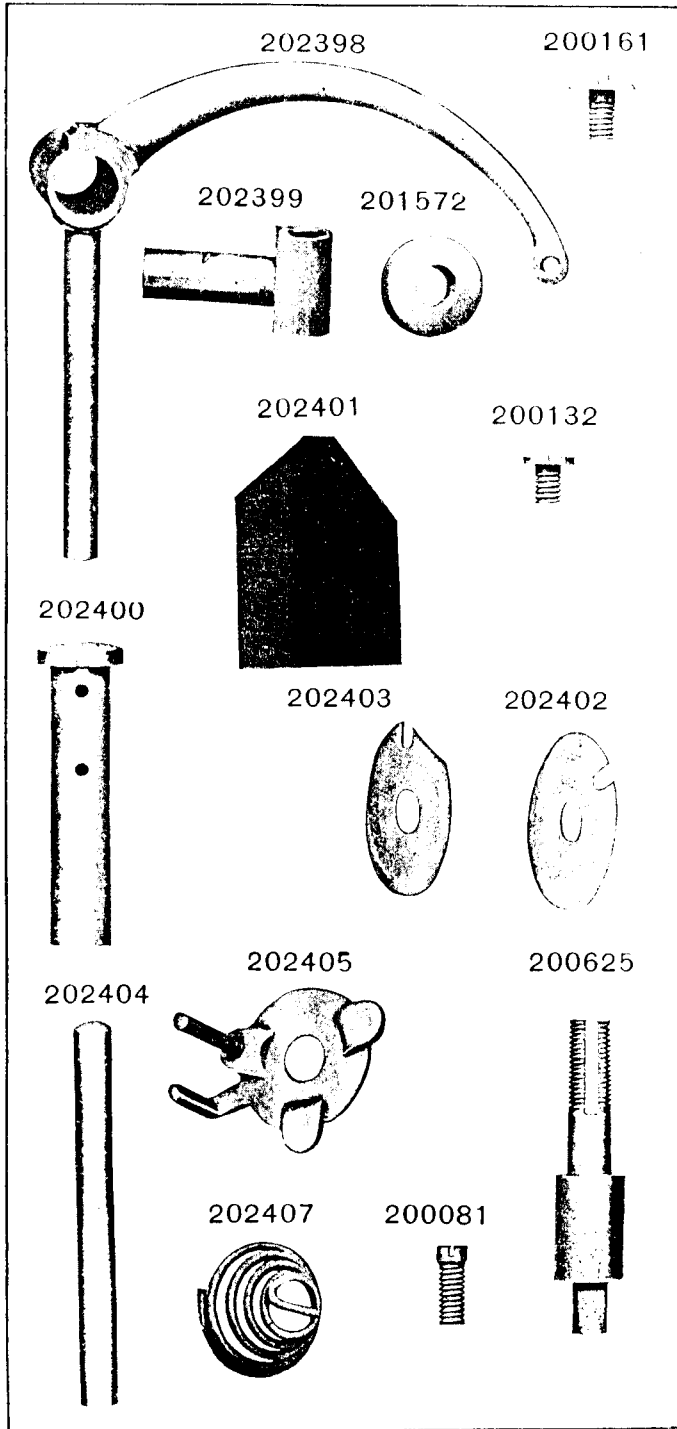


PLATE 10248—FULL SIZE

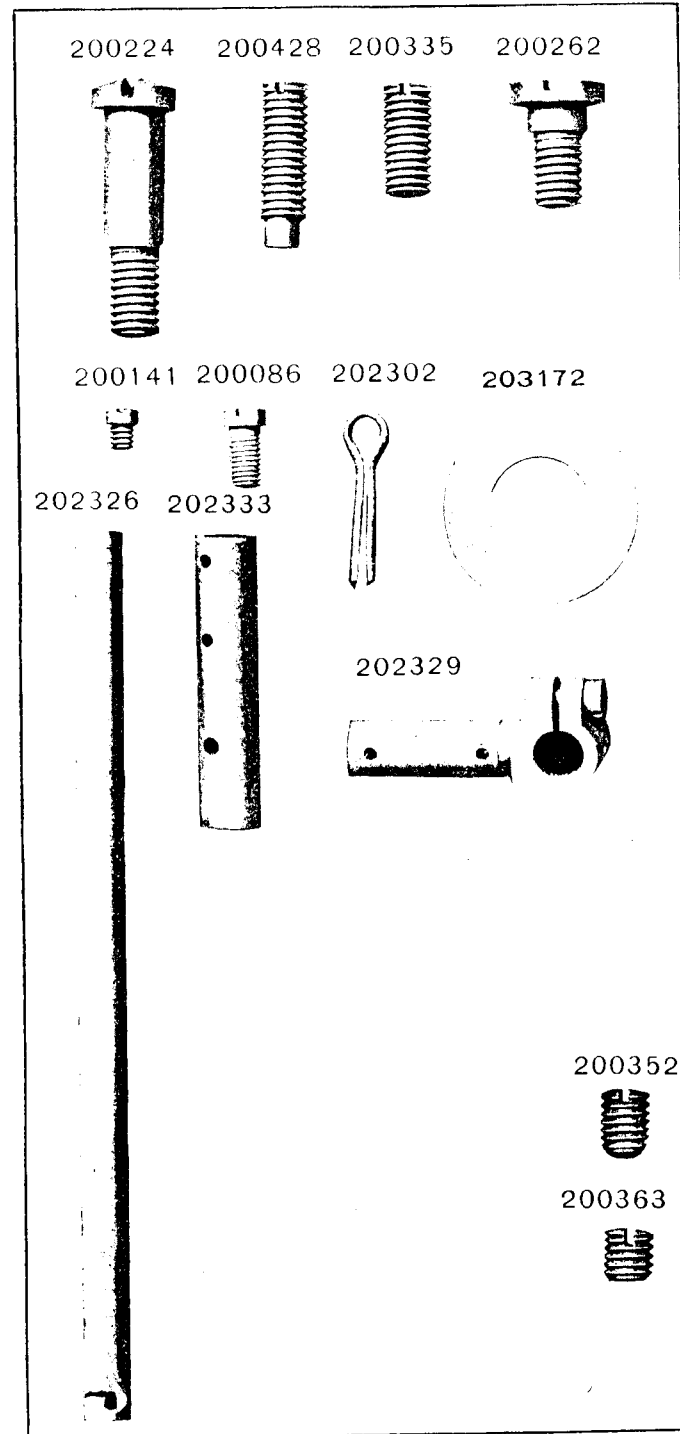


PLATE 10249—FULL SIZE

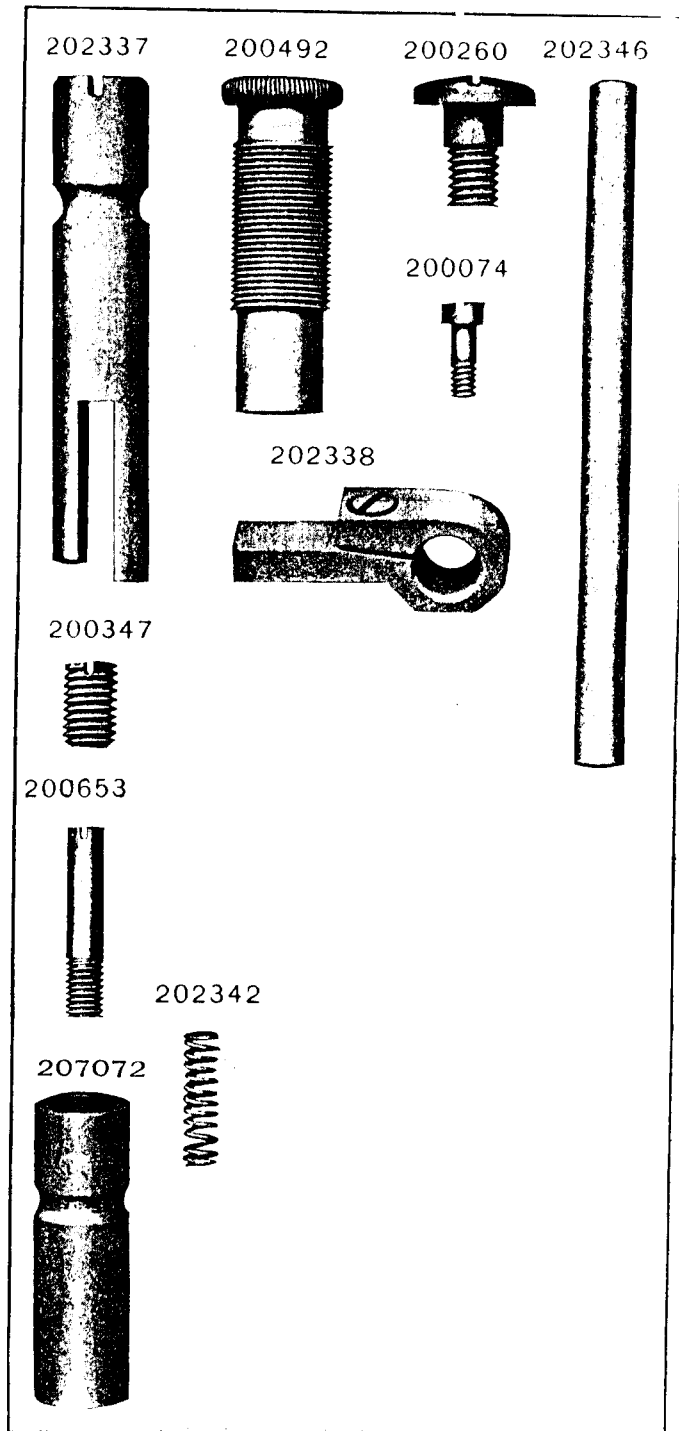


PLATE 10252—FULL SIZE

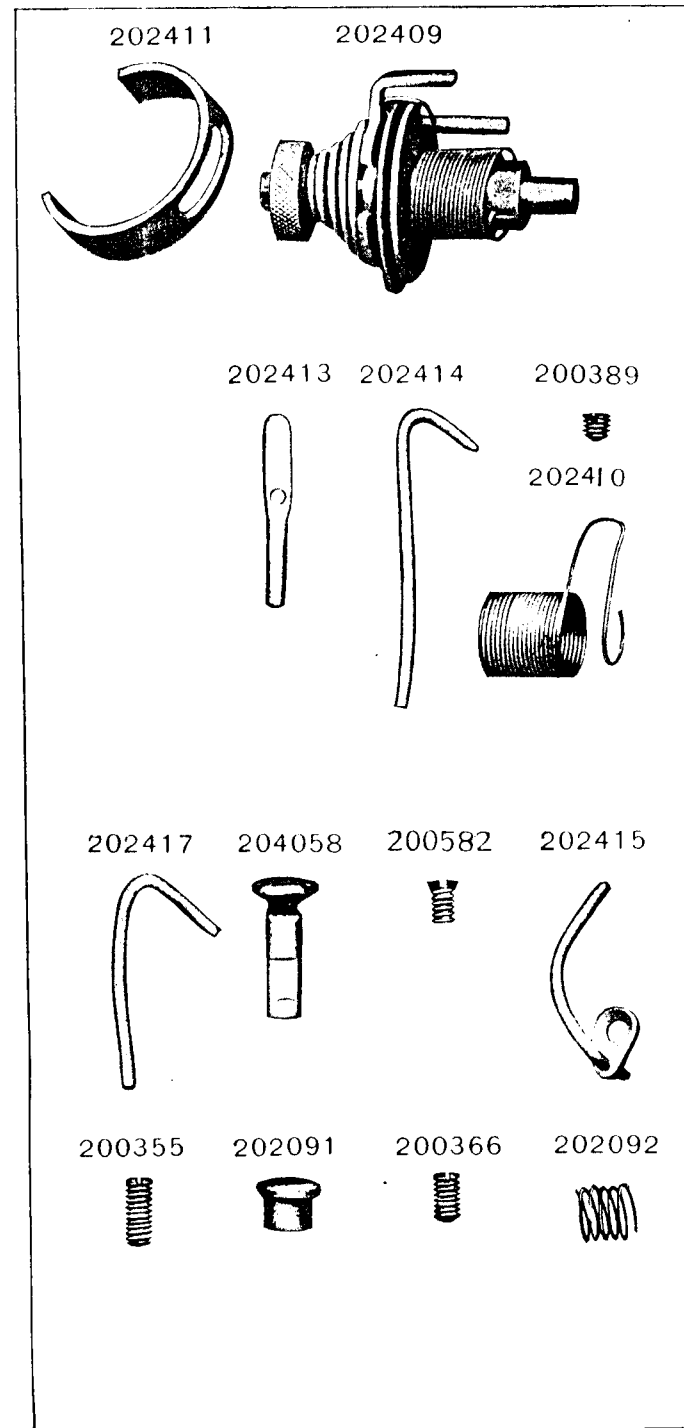


PLATE 10271—ONE-HALF SIZE

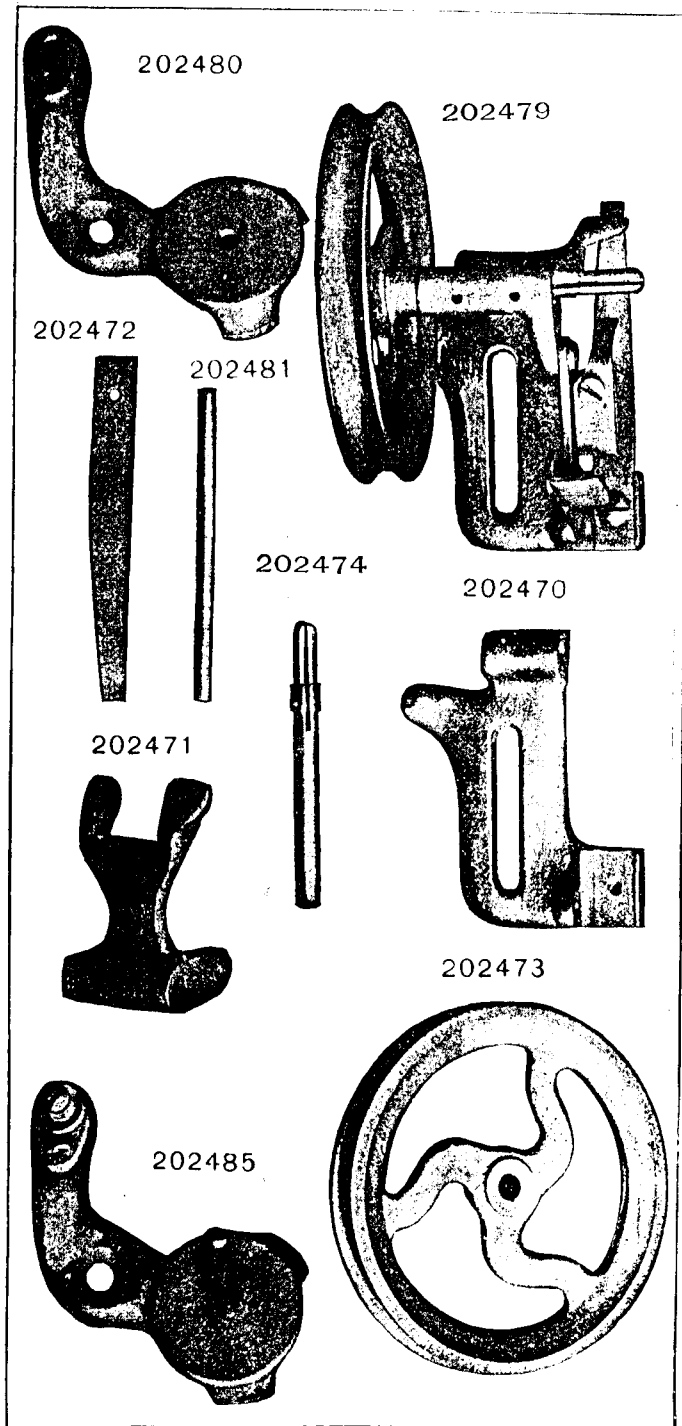


PLATE 10272—FULL SIZE

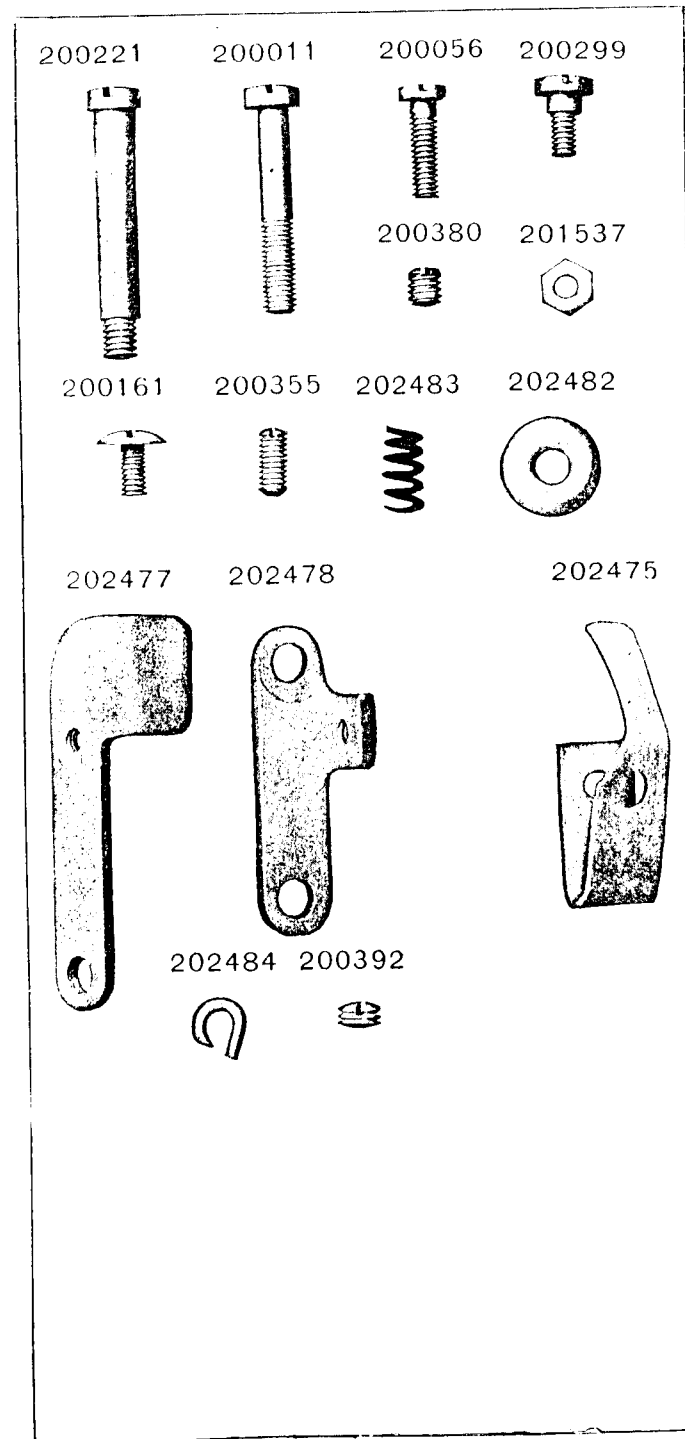
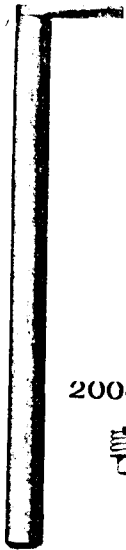


PLATE 10273-FULL SIZE

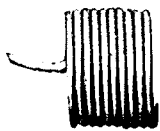
202500



200086



202504



200444



202503



202502



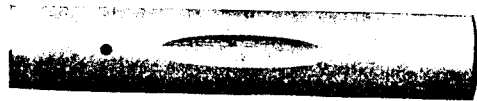
200333



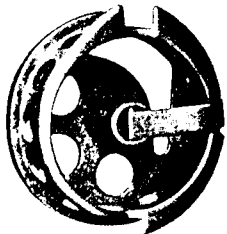
200380



202501



202796



202841

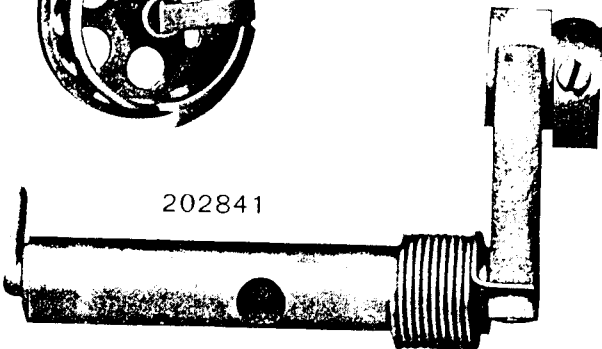
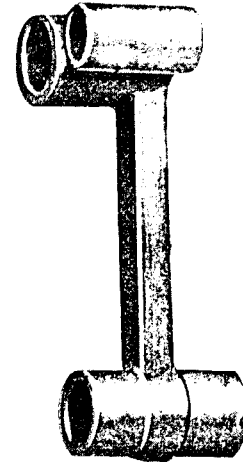


PLATE 10283-FULL SIZE

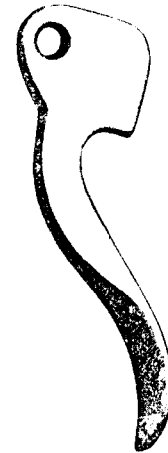
202550



202552



202554



202553

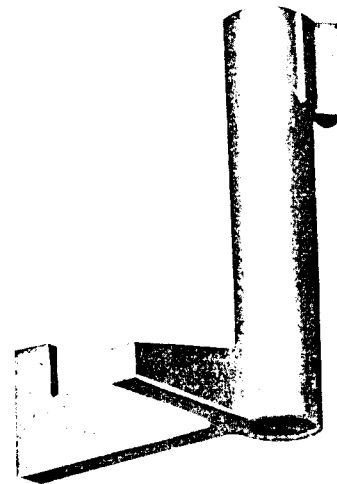


PLATE 10667 - ONE - HALF SIZE

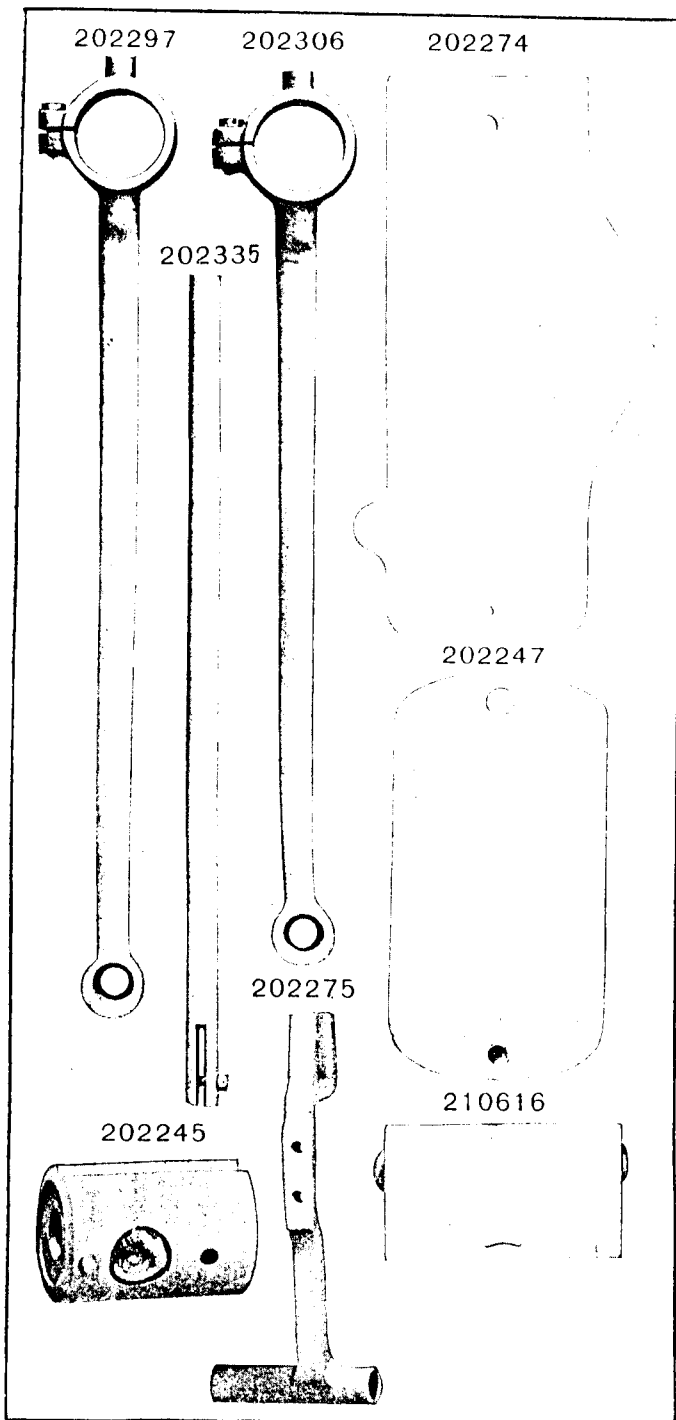


PLATE 10668 - FULL SIZE

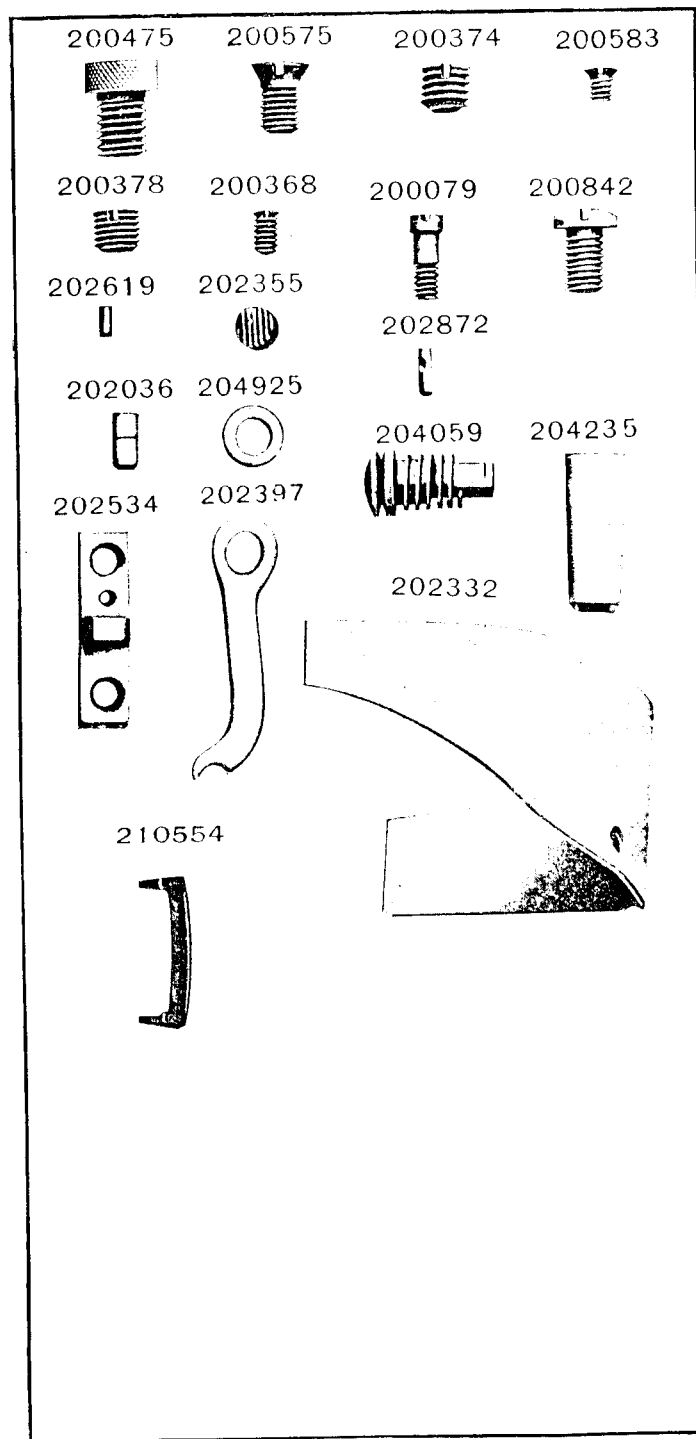
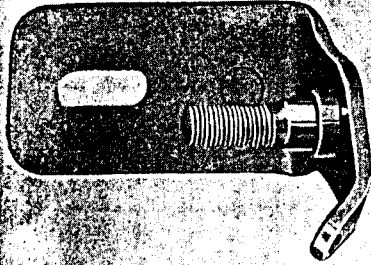


PLATE 10881—FULL SIZE

225461



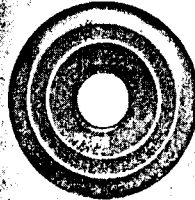
200082



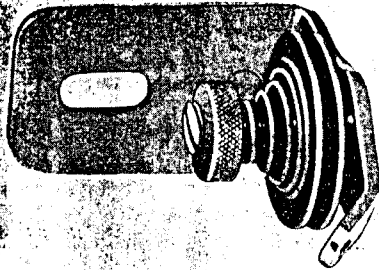
202104



2102



225462



202407



201499



201572



PLATE 10882—FULL SIZE

225453



225455



225438



225457



201052



200056



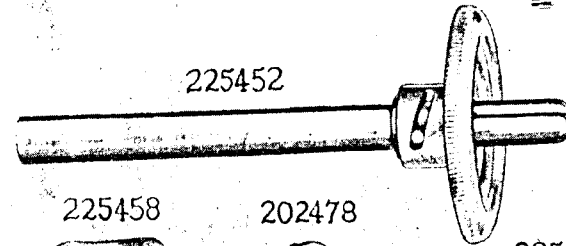
200299



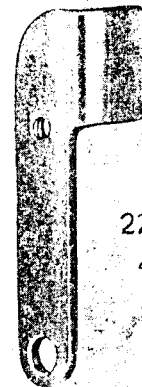
225454



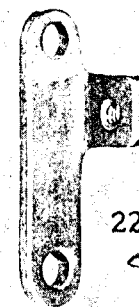
225452



225458



202478



225444



225459



225460

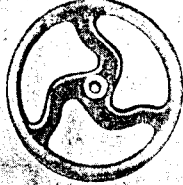


PLATE 10883—ONE-FOURTH SIZE

225463



202473



225436

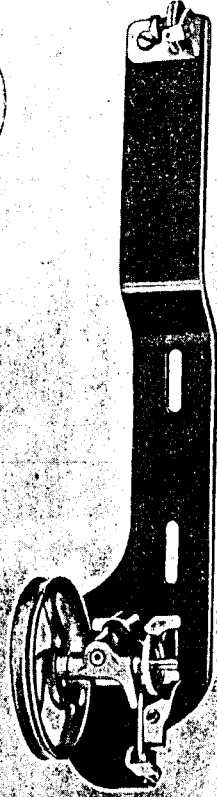
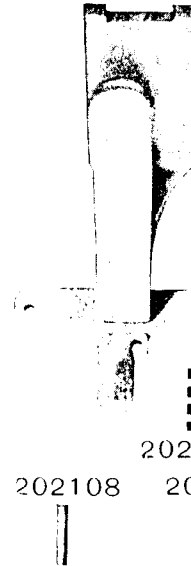
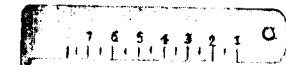


PLATE 10921—FULL SIZE

203768



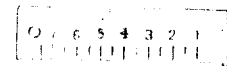
202396



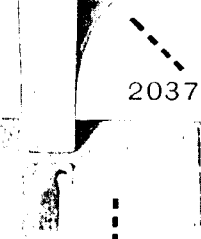
202763



202394



203767



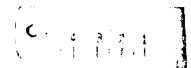
202379



202808



202393



202395

202799

202108



202392



PLATE 10936 - ONE-FOURTH SIZE

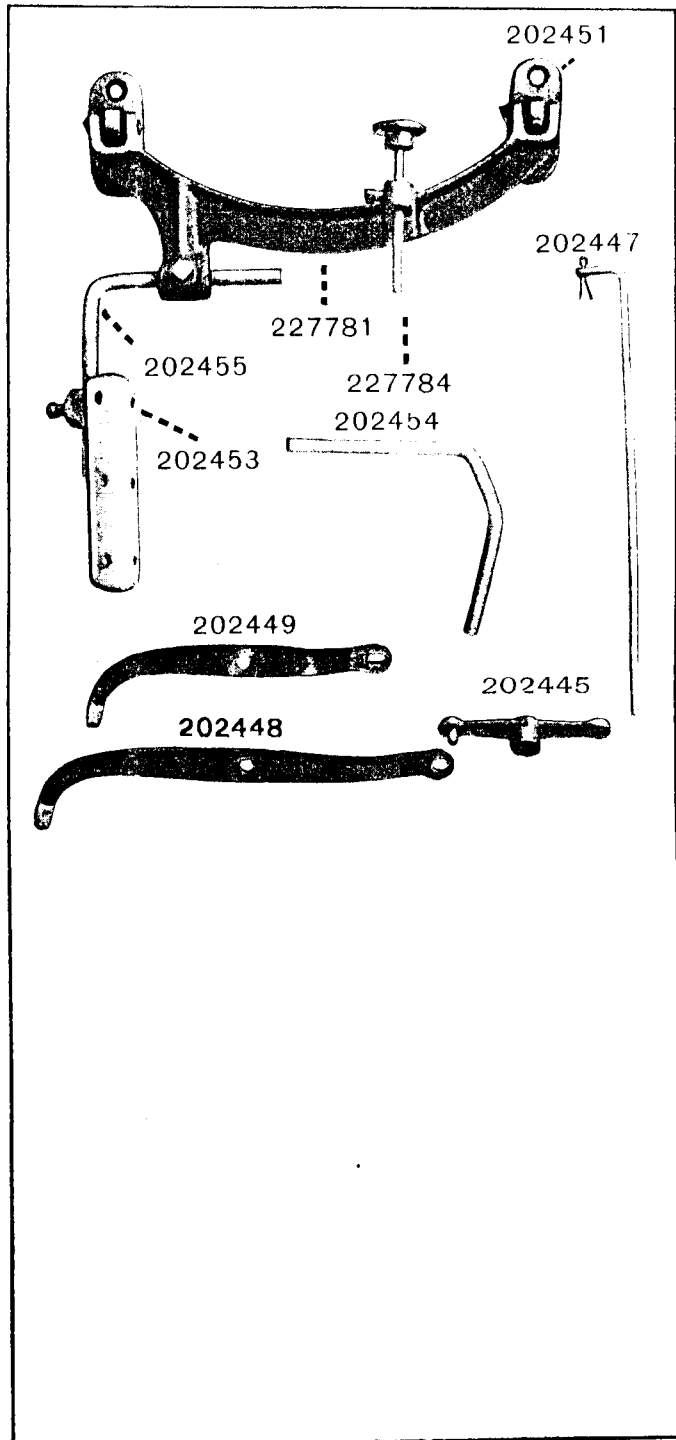
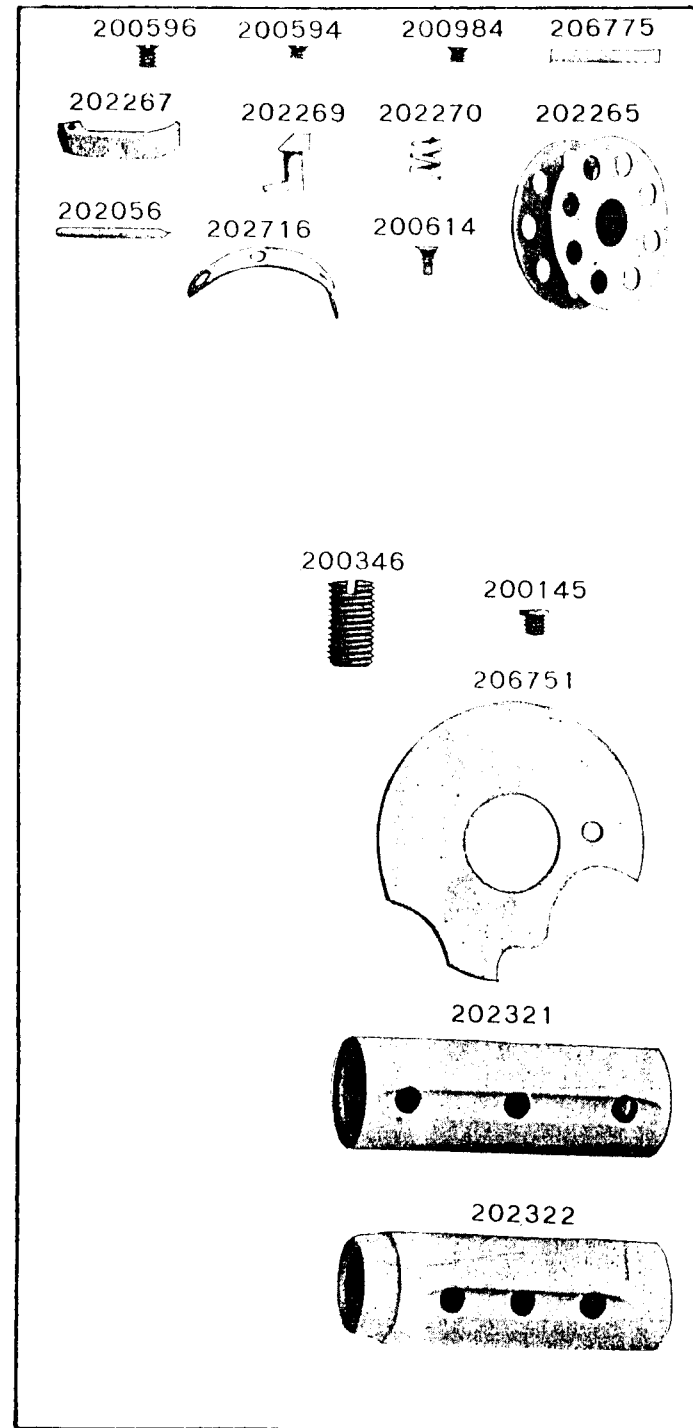


PLATE 11671-FULL SIZE



200596 200594 200984 206775

202267 202269 202270 202265

202056 202716 200614

200346 200145

206751

202321

202322

PLATE 12153-ONE-HALF SIZE

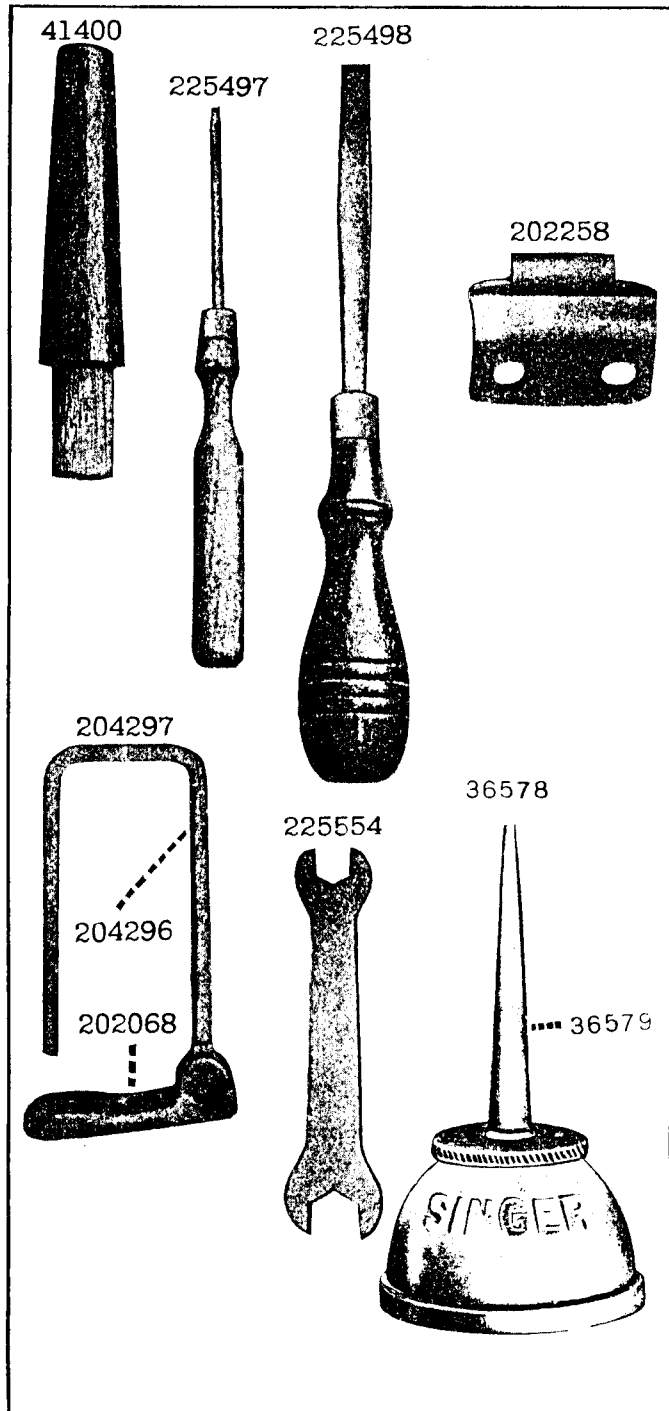


PLATE 13351-ONE-HALF SIZE

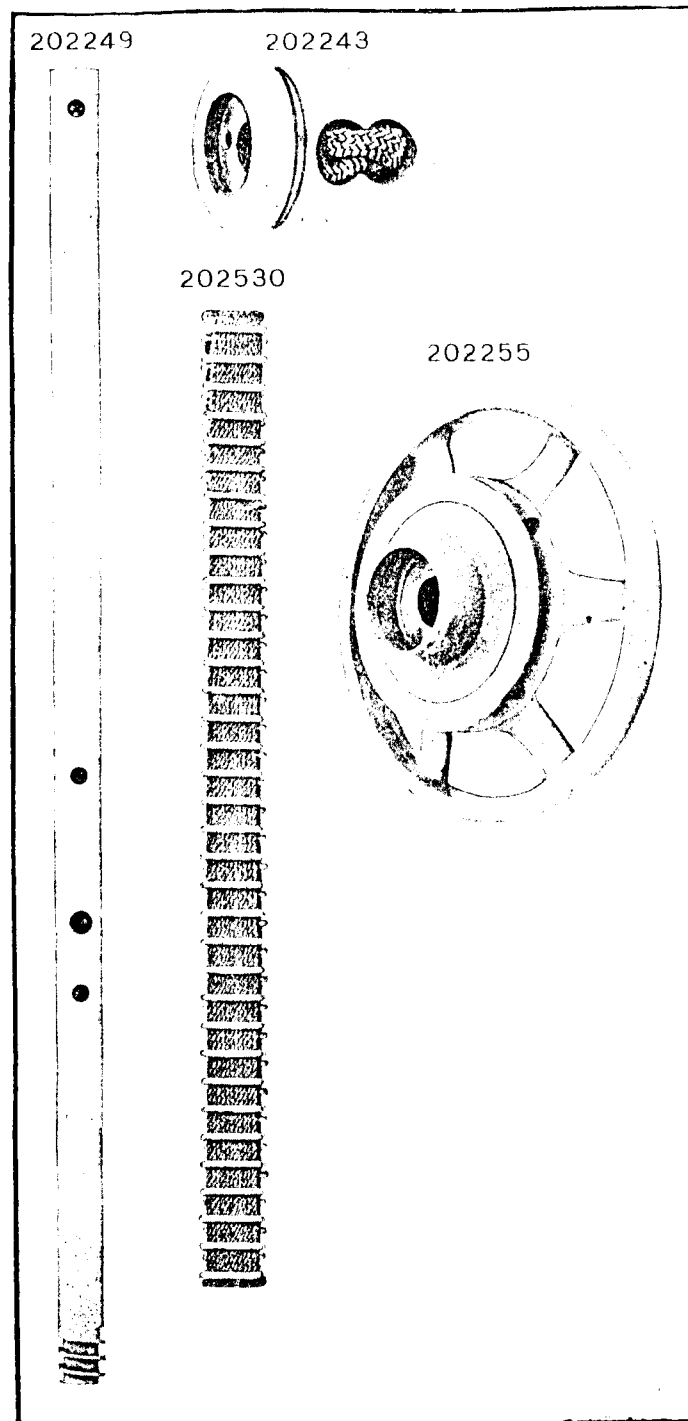


PLATE 13352—ONE-HALF SIZE

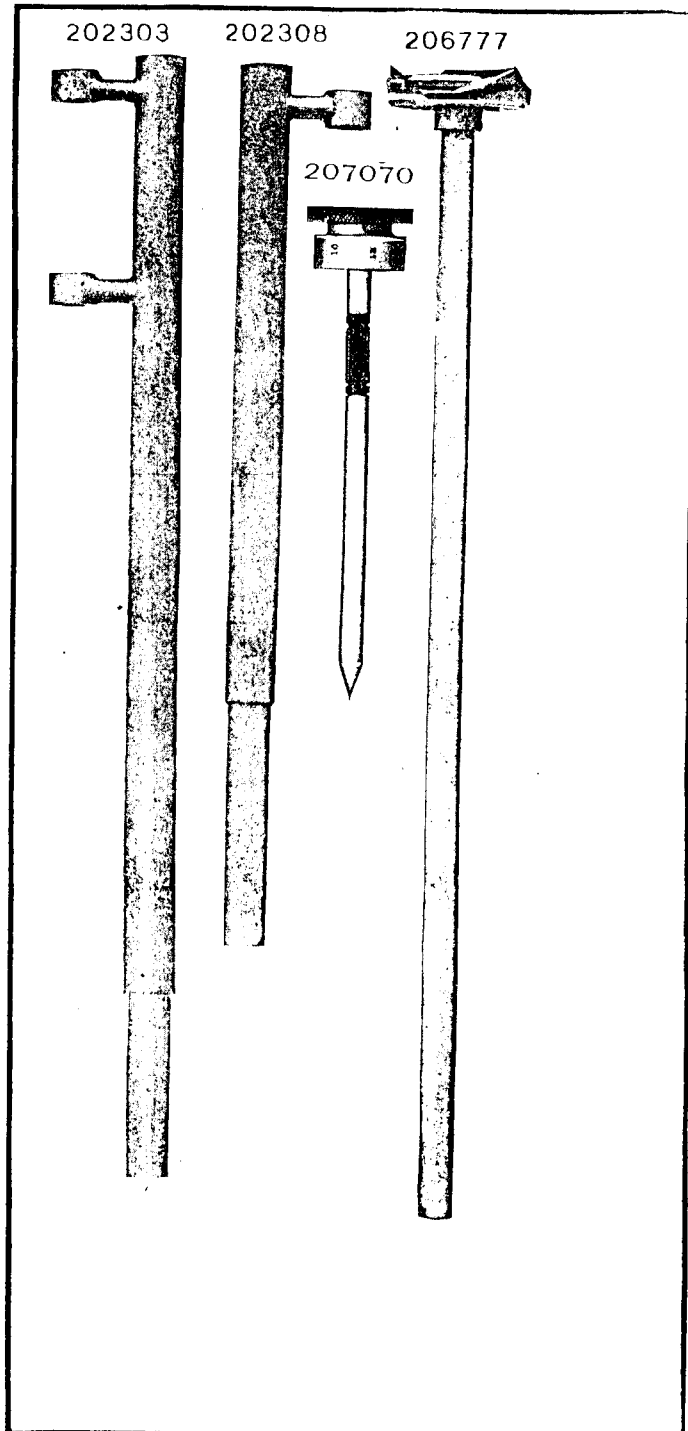


PLATE 13353—FULL SIZE

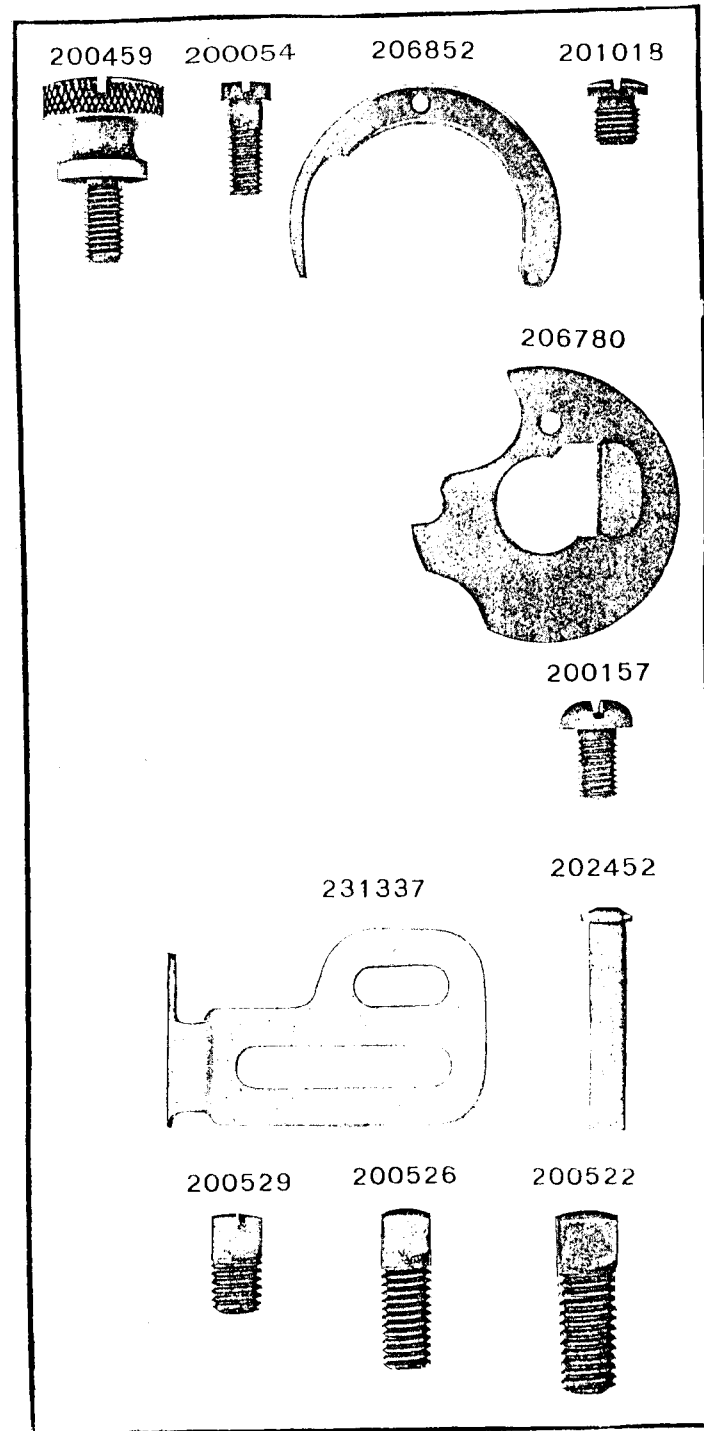


PLATE 13363-FULL SIZE

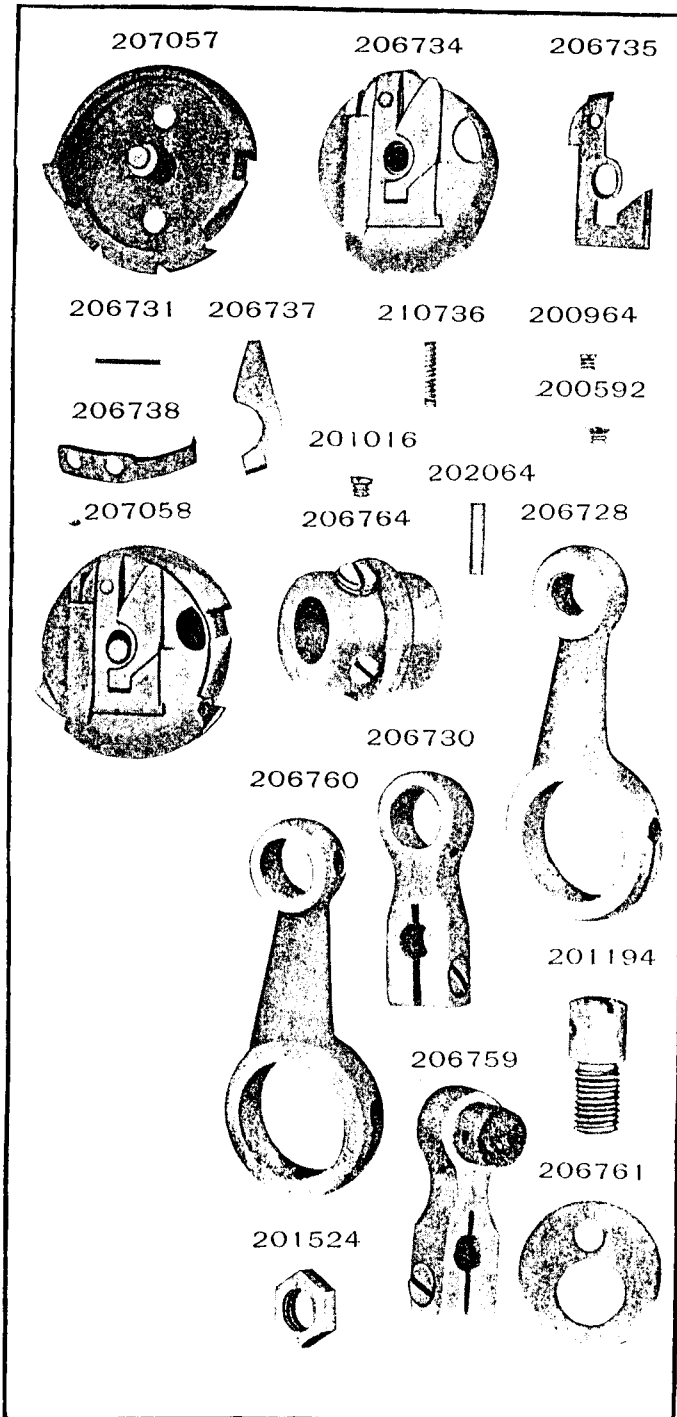


PLATE 13364-ONE-HALF SIZE

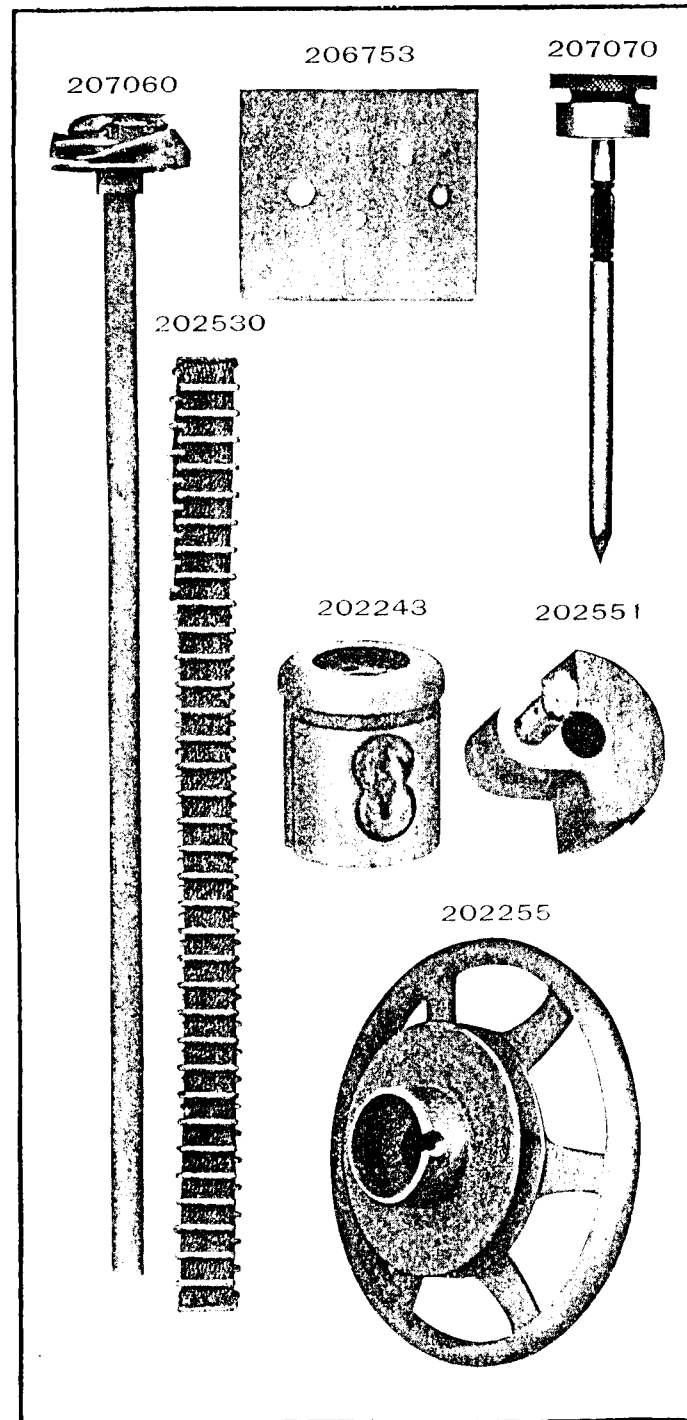
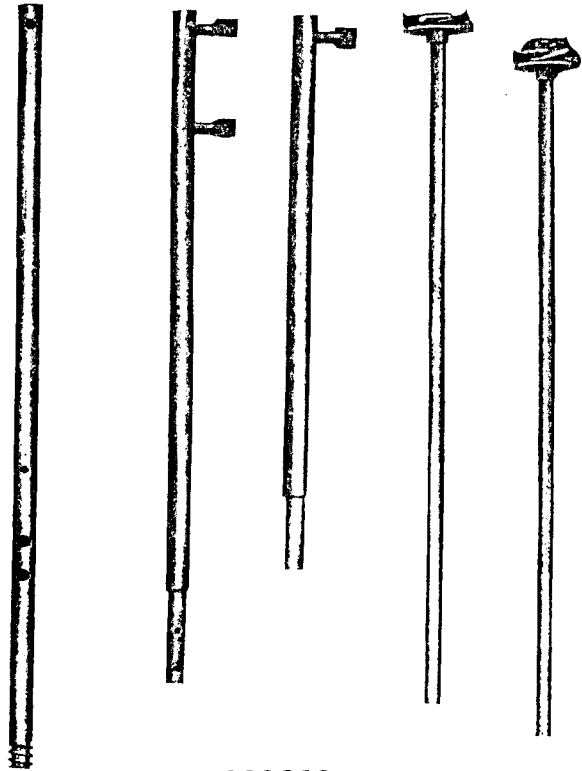


PLATE 13365-ONE-FOURTH SIZE

202250 202304 202654 206754 207061

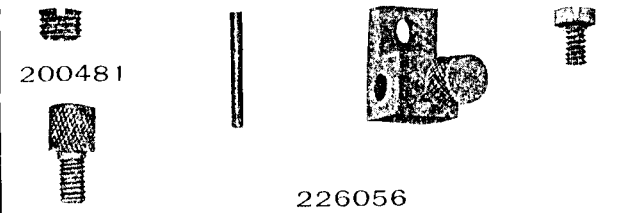


225663

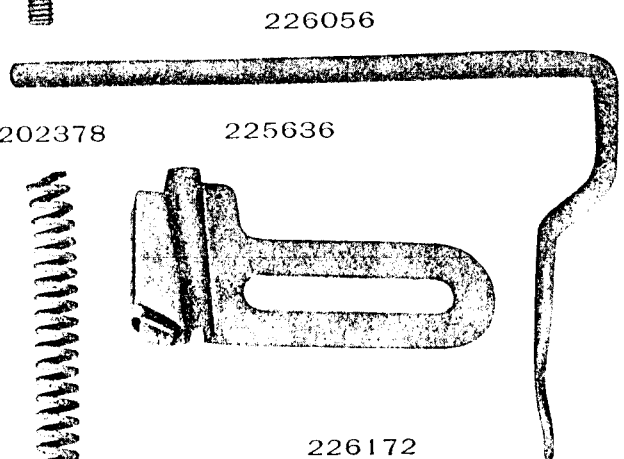


PLATE 13366-FULL SIZE

200382 202090 226057 200118



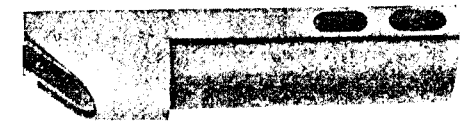
200481



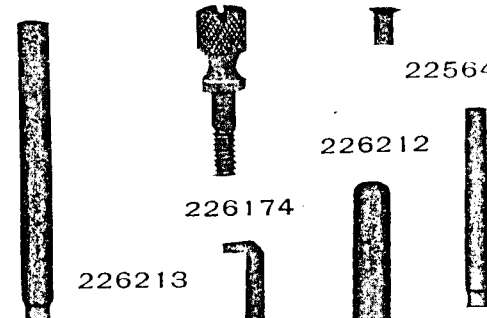
202378



226172



225664 200896 205520



225648

226212

226174

226213

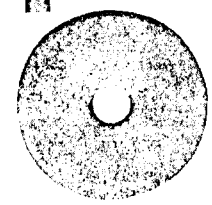
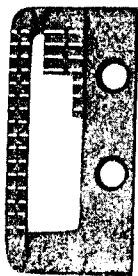
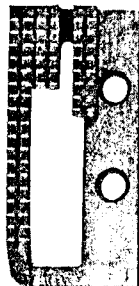


PLATE 13367-FULL SIZE

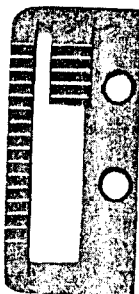
202286



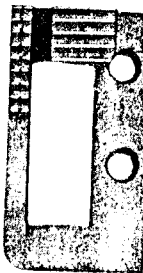
202288



226171



230598



202284



226190

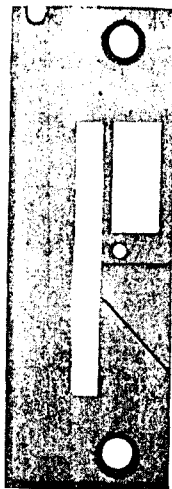
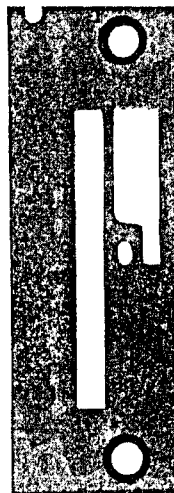
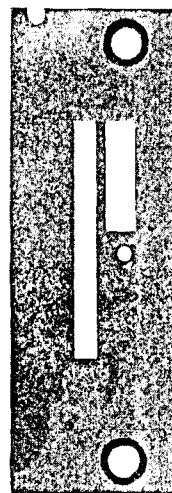


PLATE 13368-FULL SIZE

202826



202812



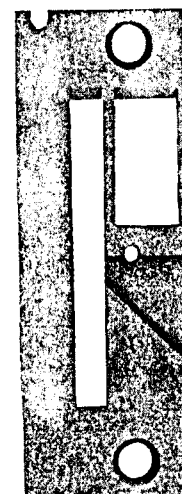
202821



202823



203102



203193



PLATE 13369-FULL SIZE

229867



207024



206830



206832



206998



200543



PLATE 13370-ONE-HALF SIZE

226173



230650

