

**SINGER**  
**46K50,K52**

Form K5696  
(Supersedes K3650)

# Illustrated List of Parts

FOR

## Nos. 46K50 to 46K52 Machines

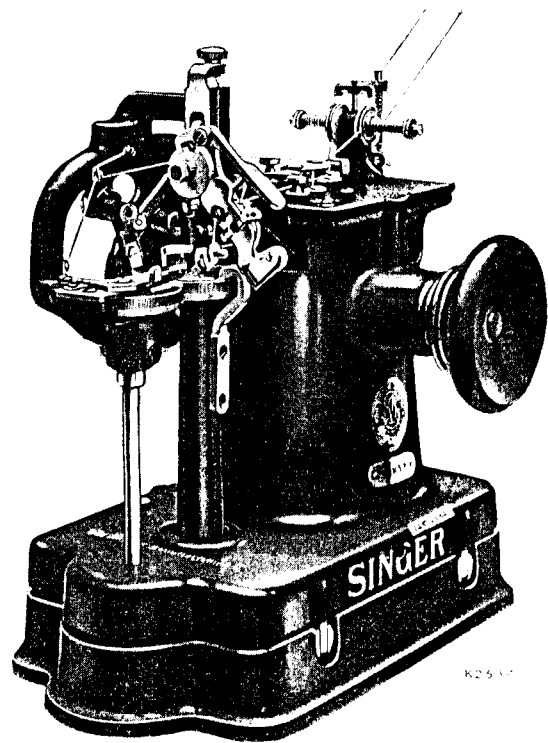

Machine No. 46K52

THE SINGER MANUFACTURING COMPANY

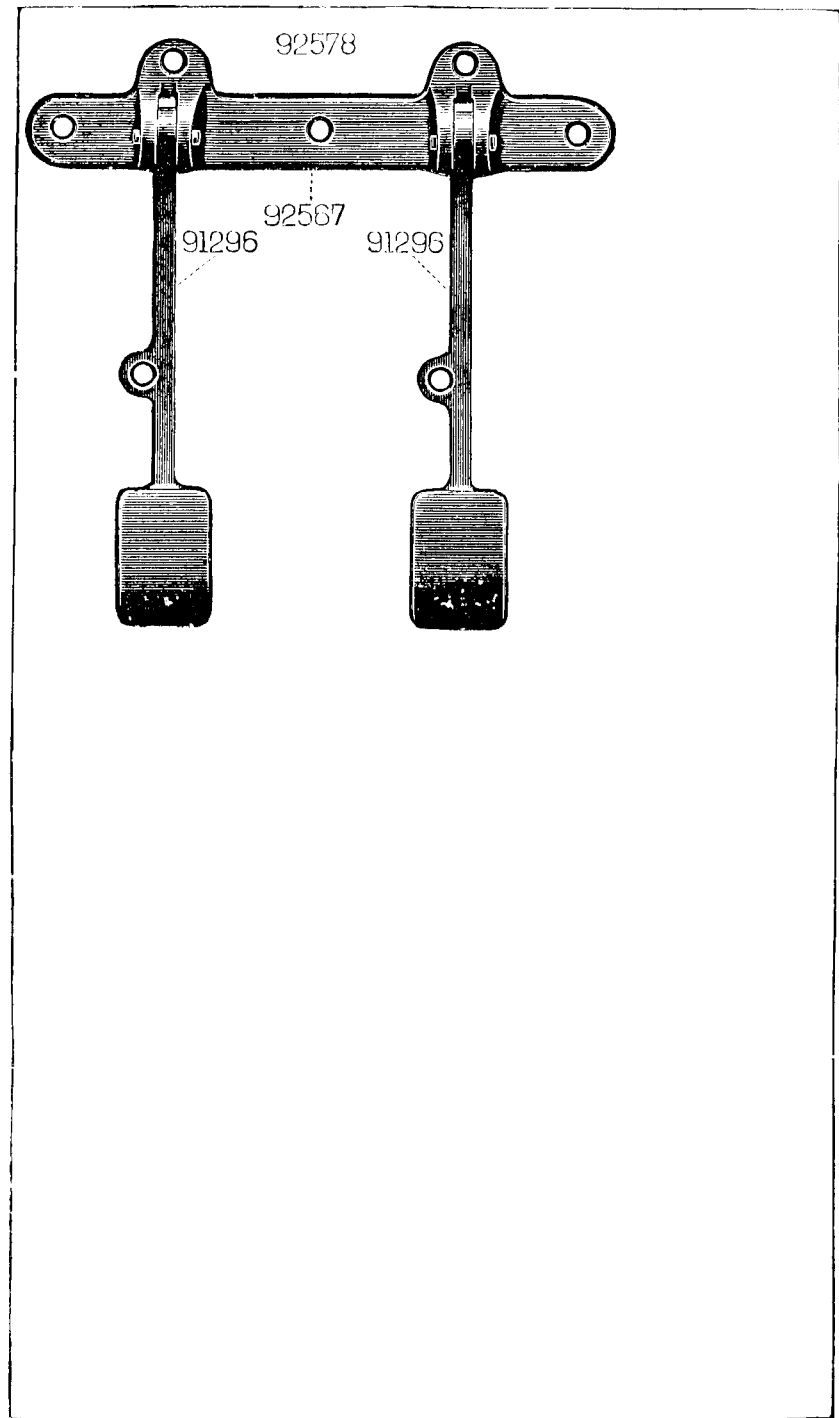

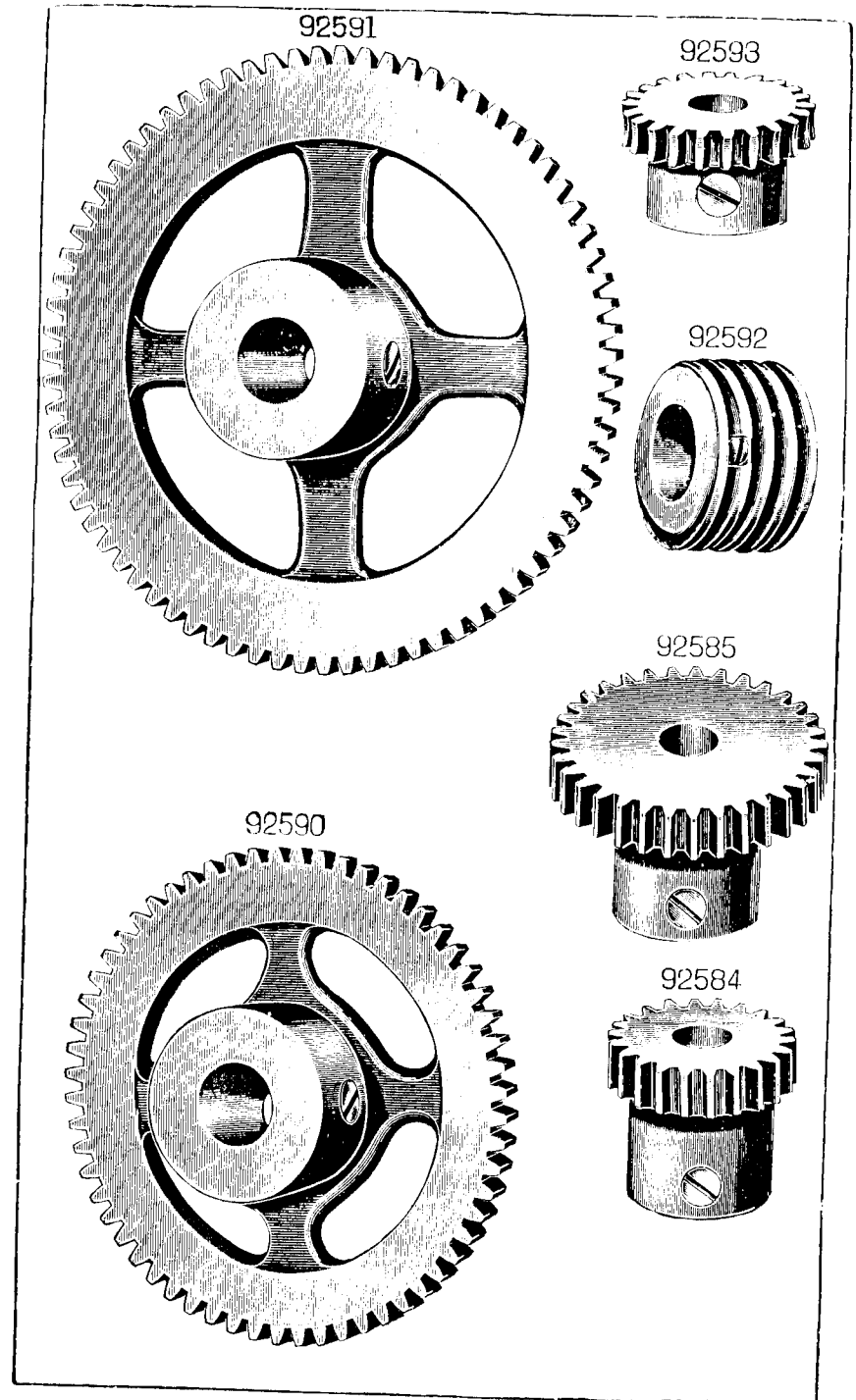
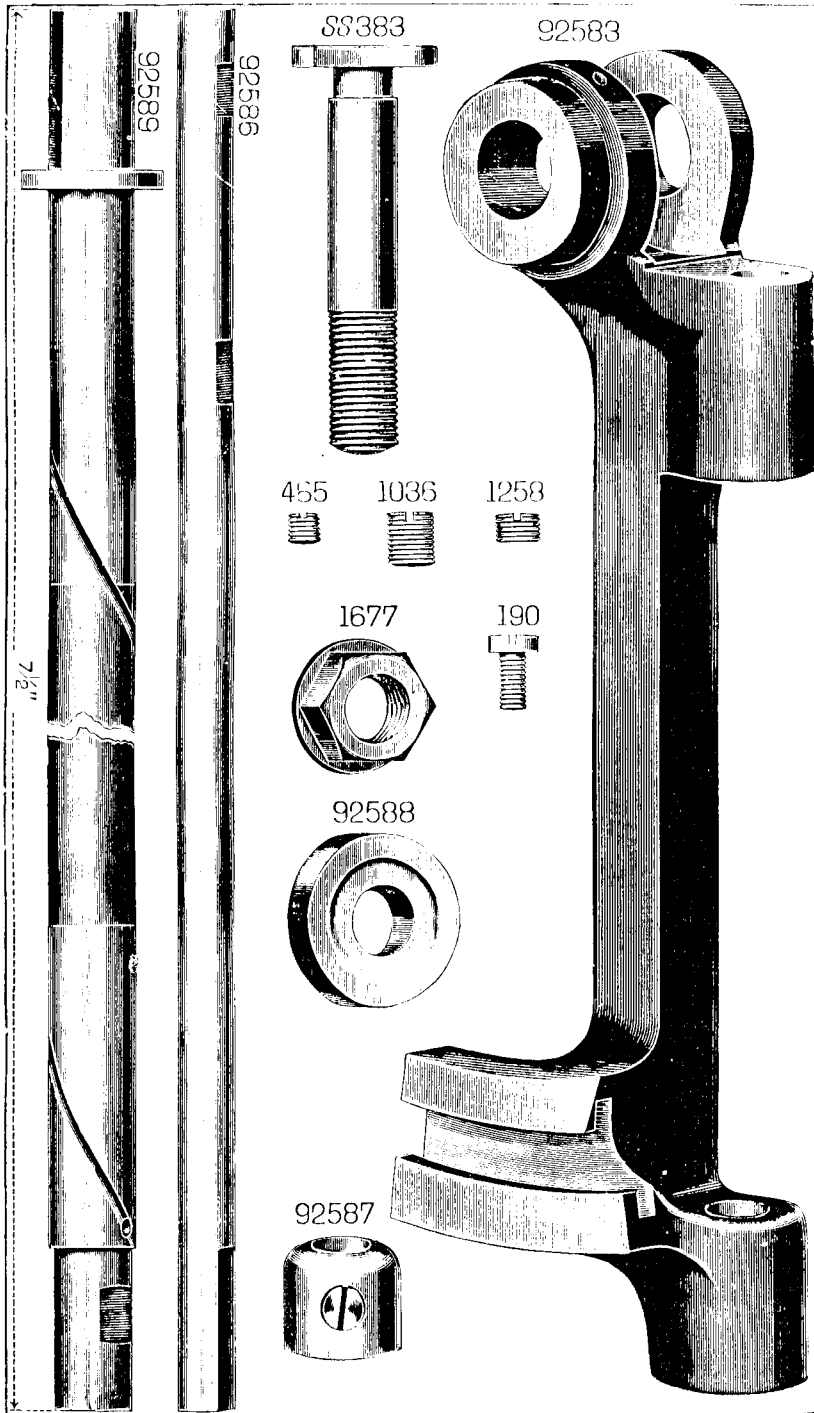

25537

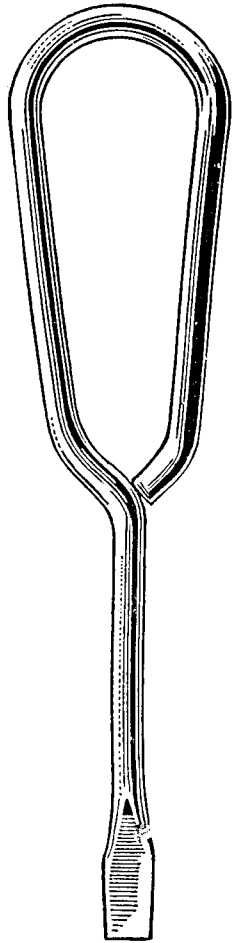

86405



36569

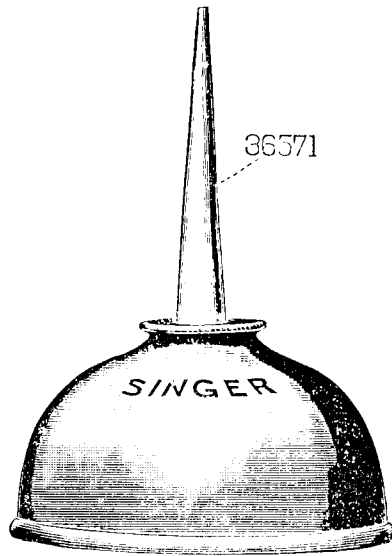

36571

SINGER

95377



92599

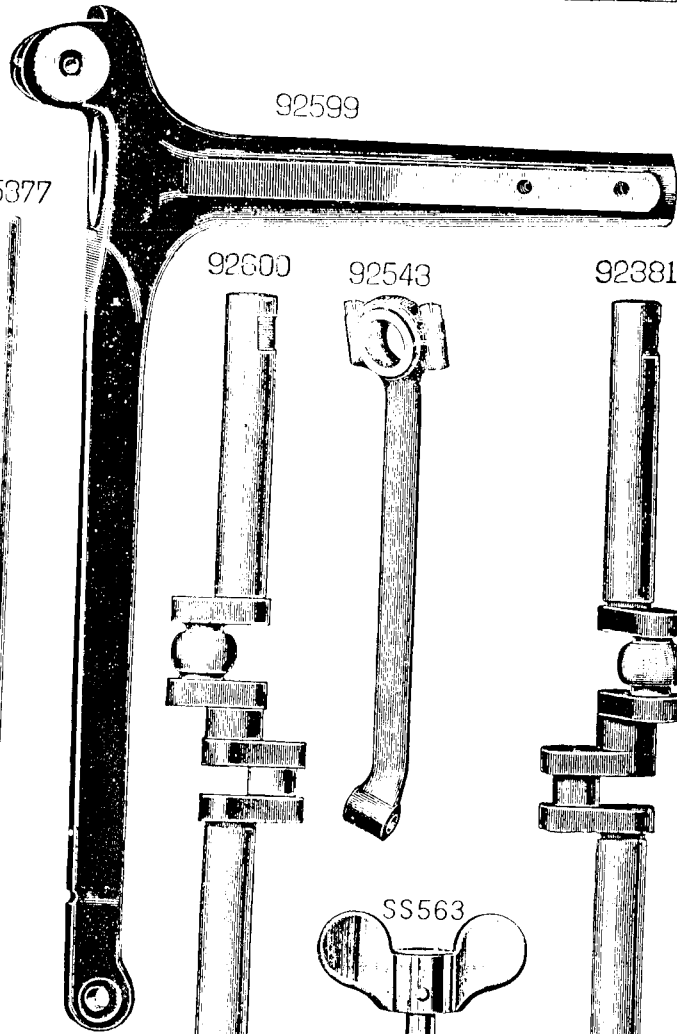

92600

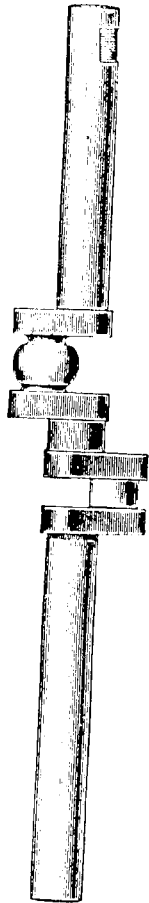

92543

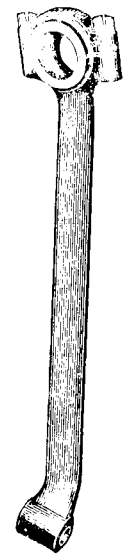

92381

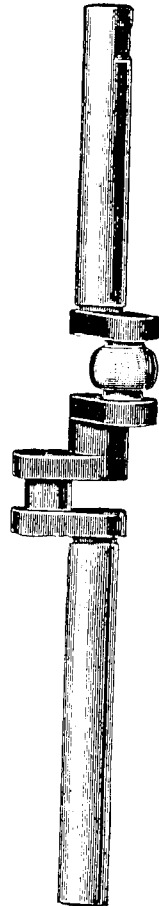

SS563

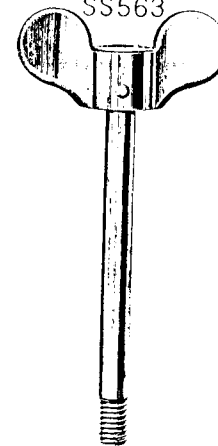

92498

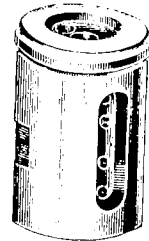

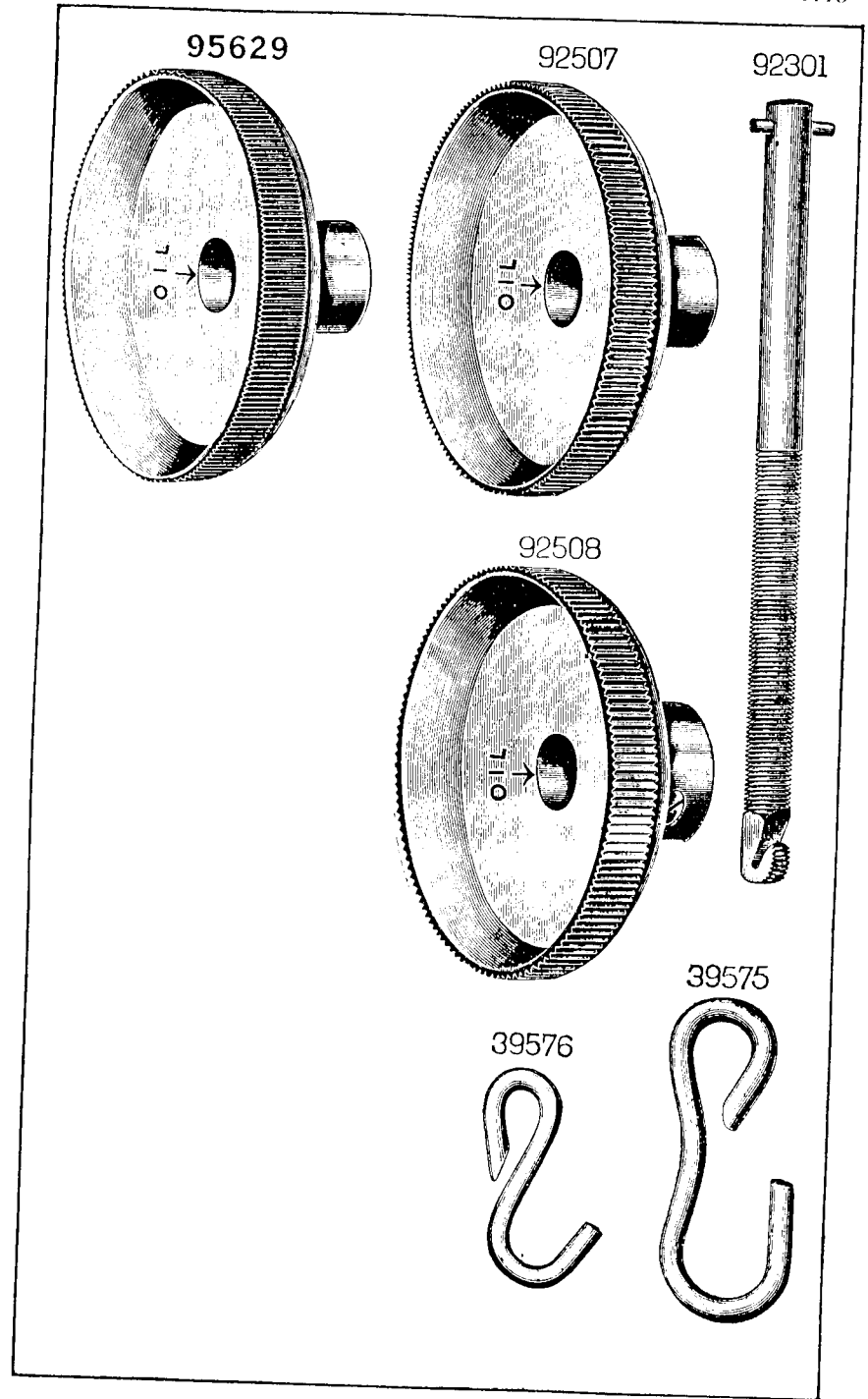
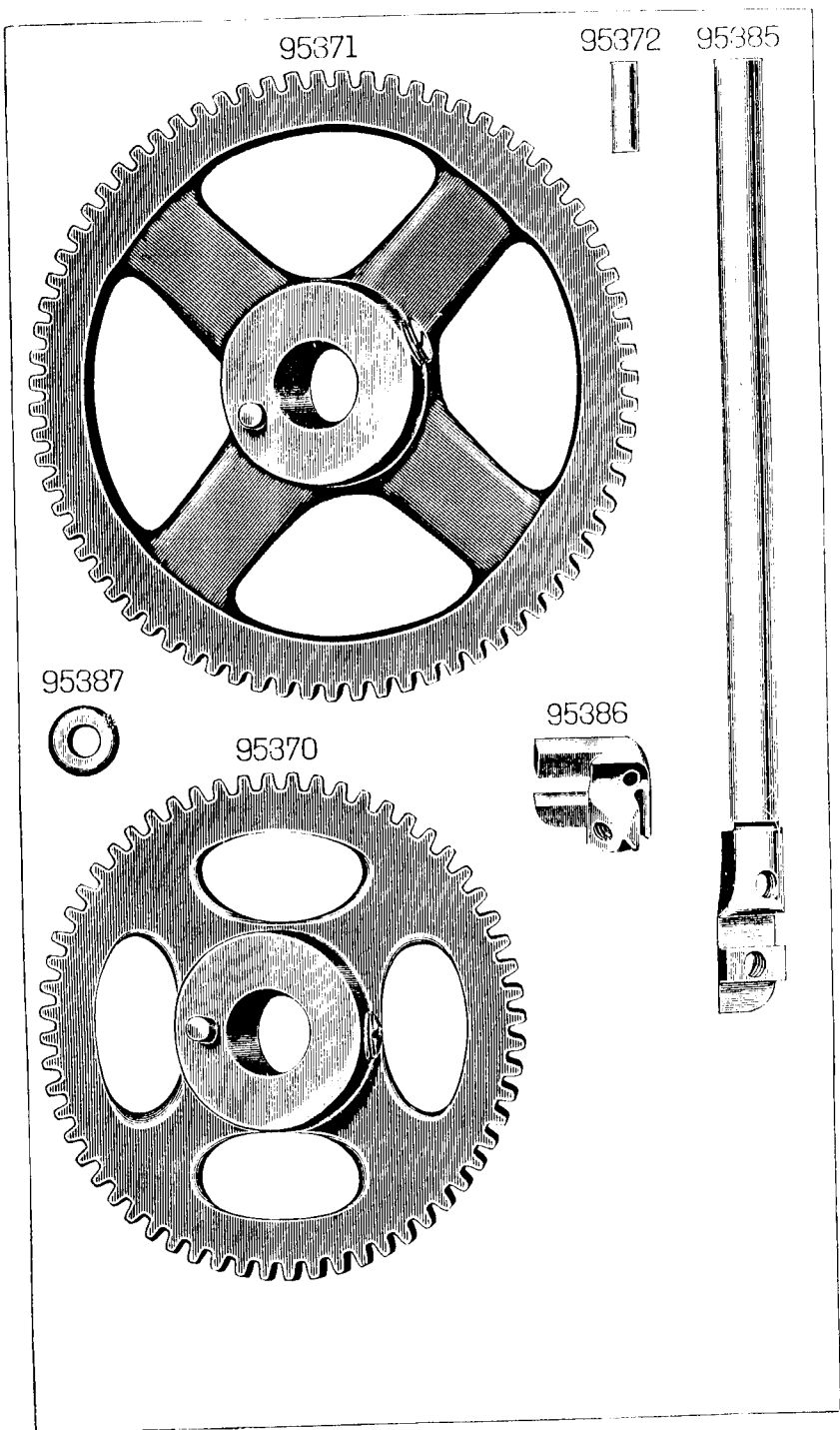

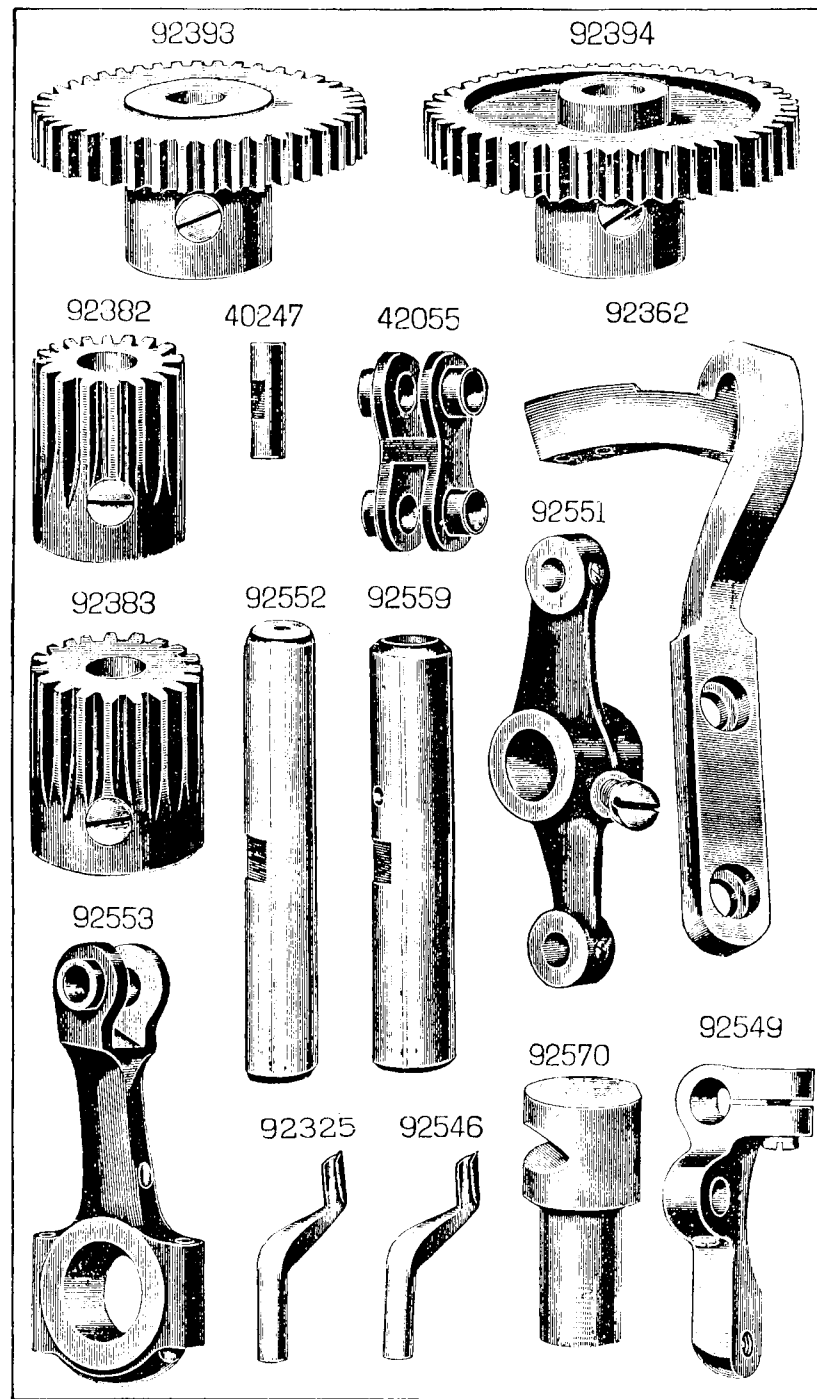
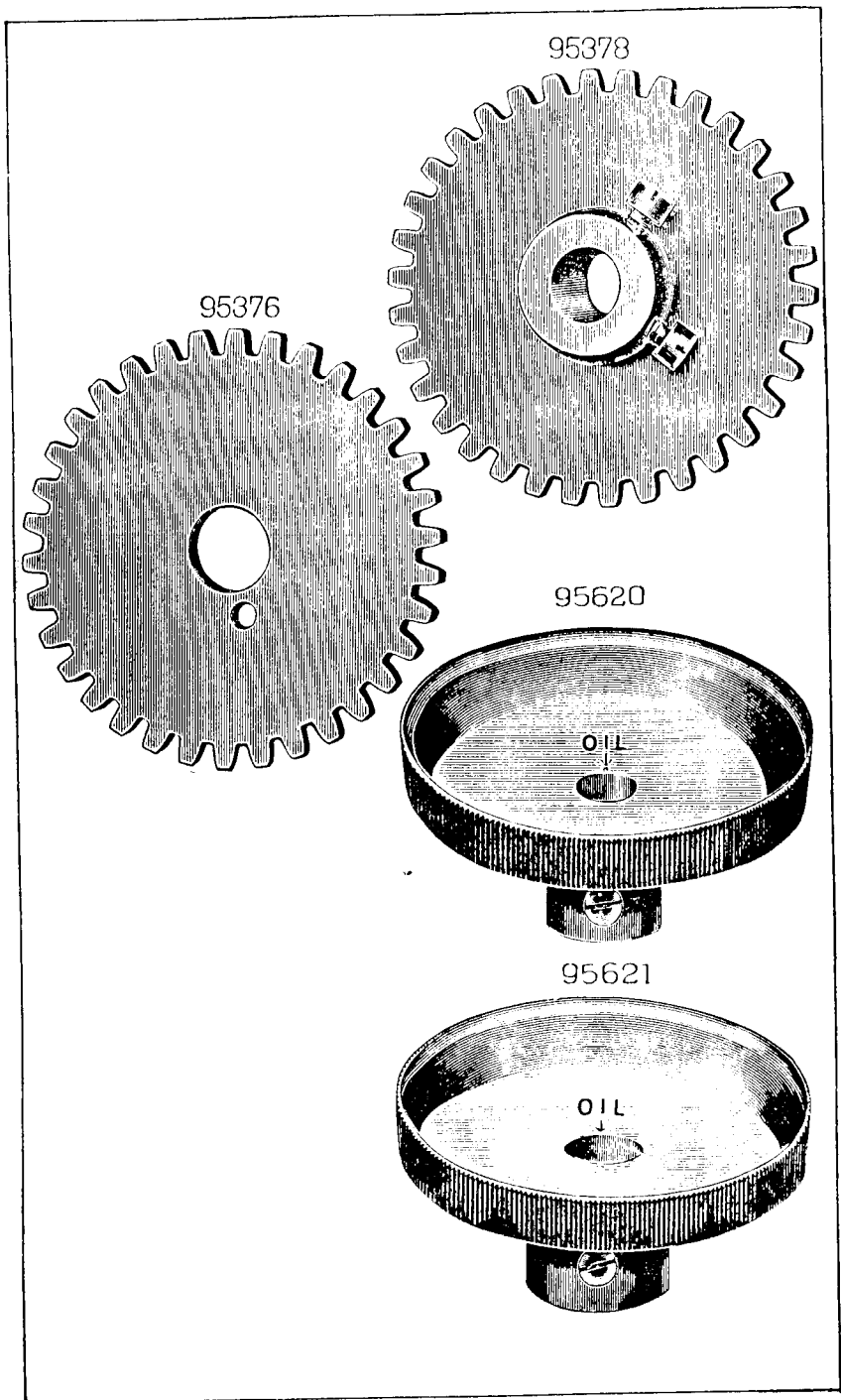

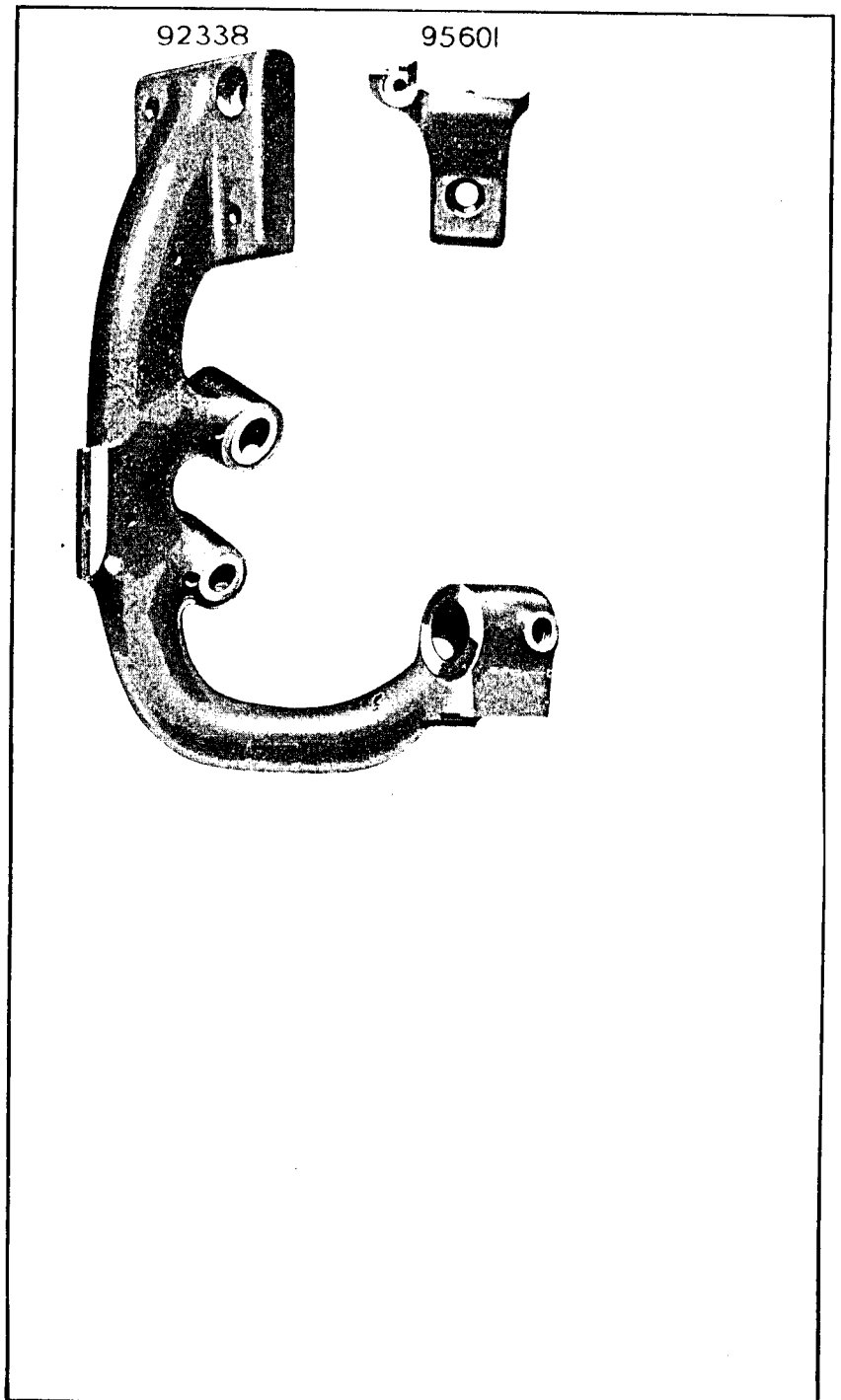
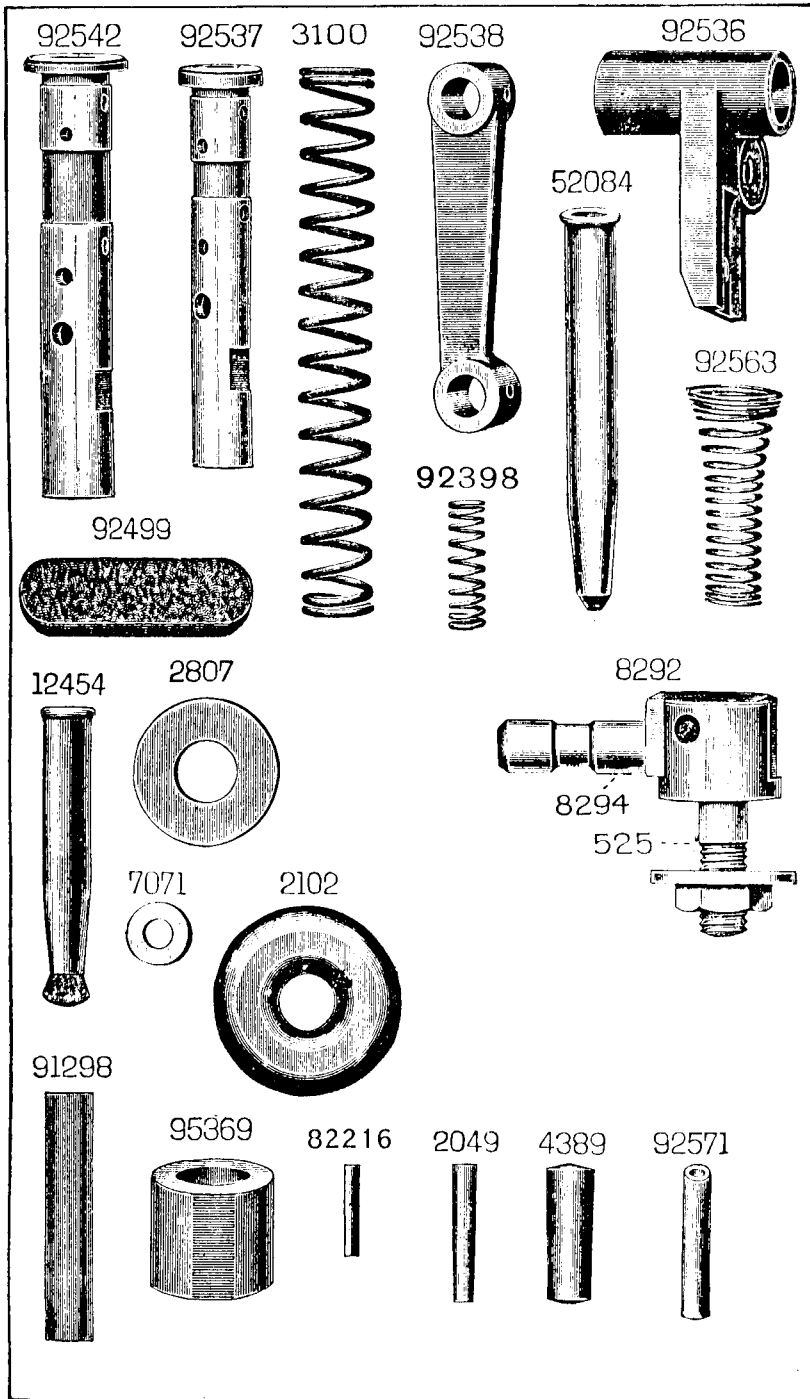



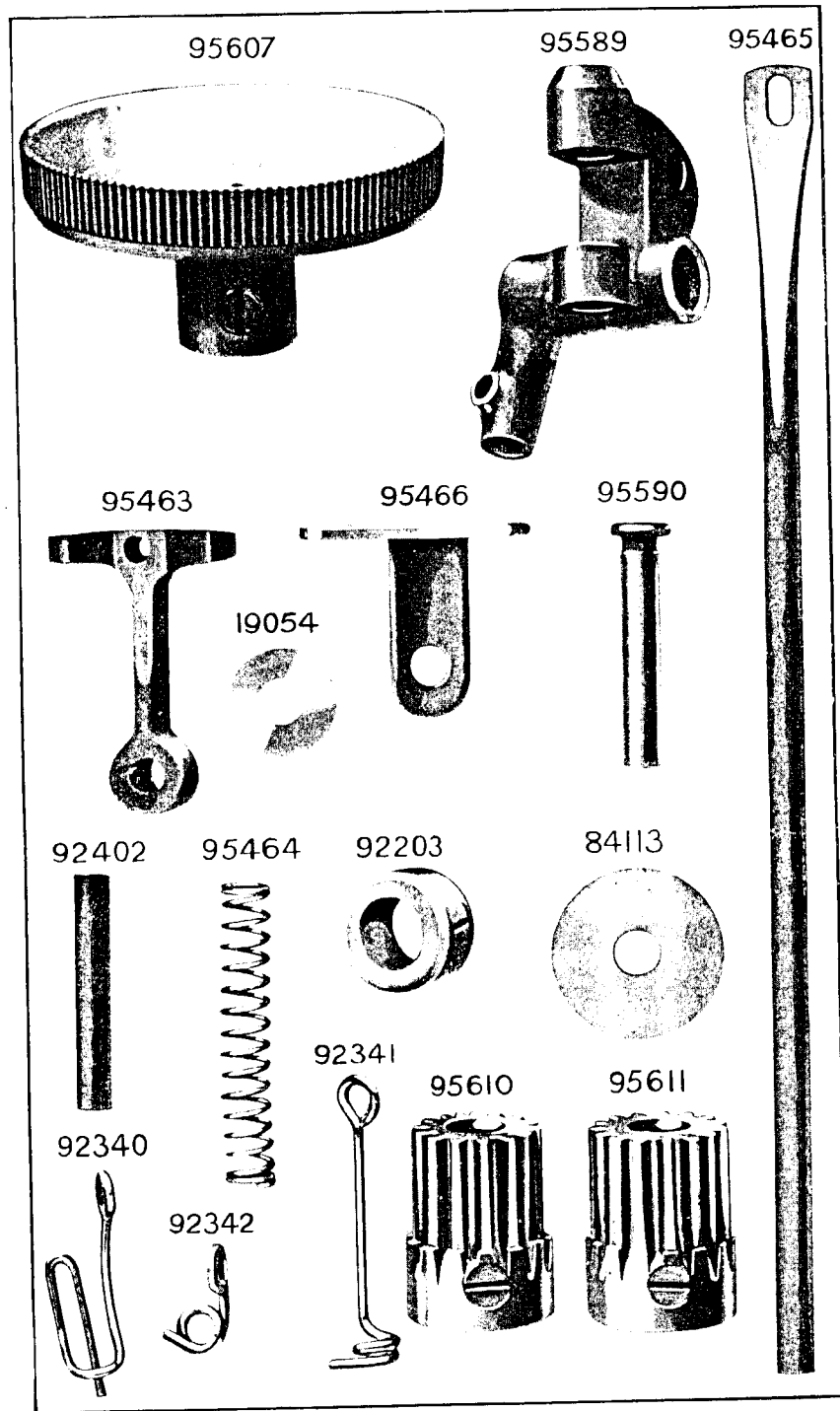
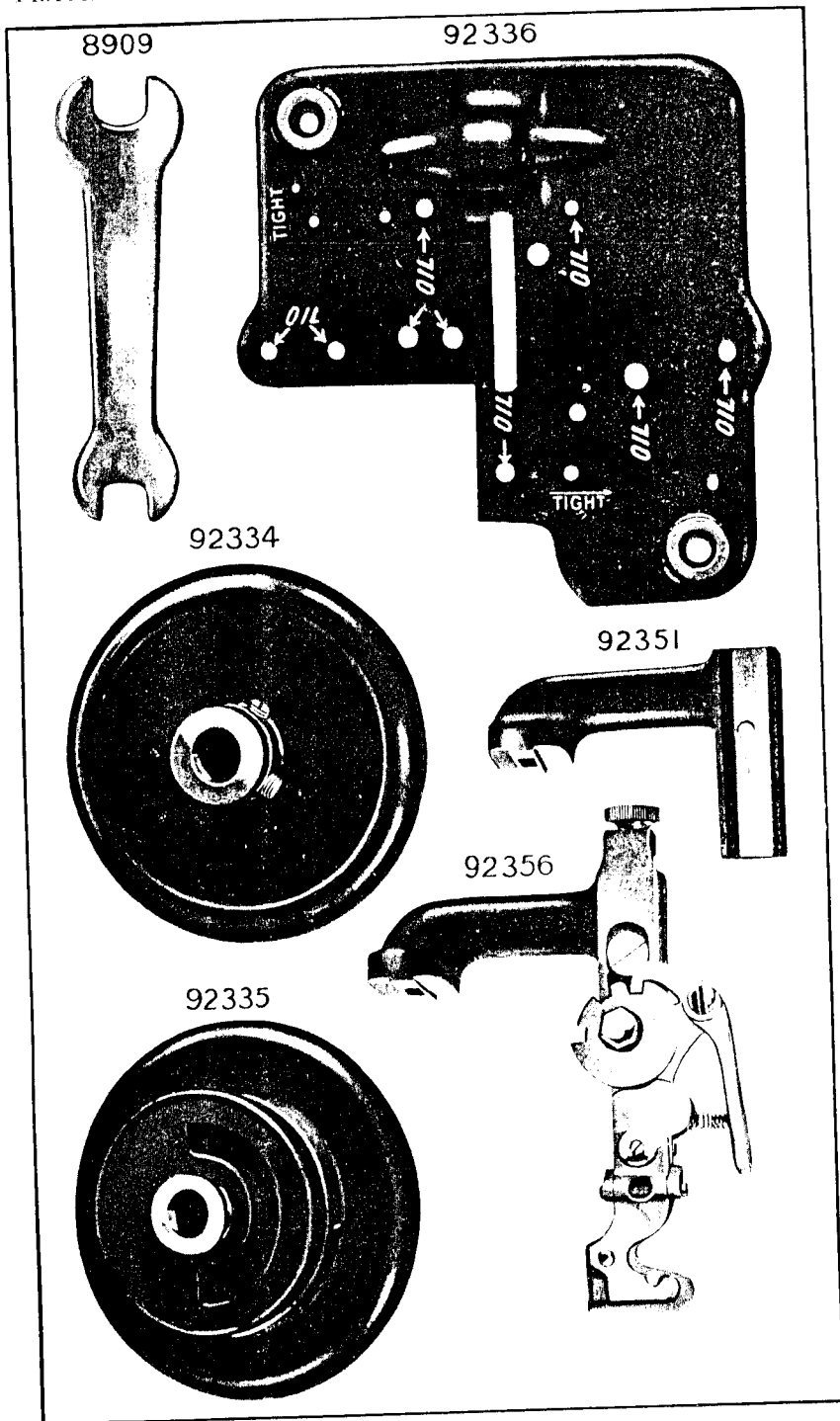

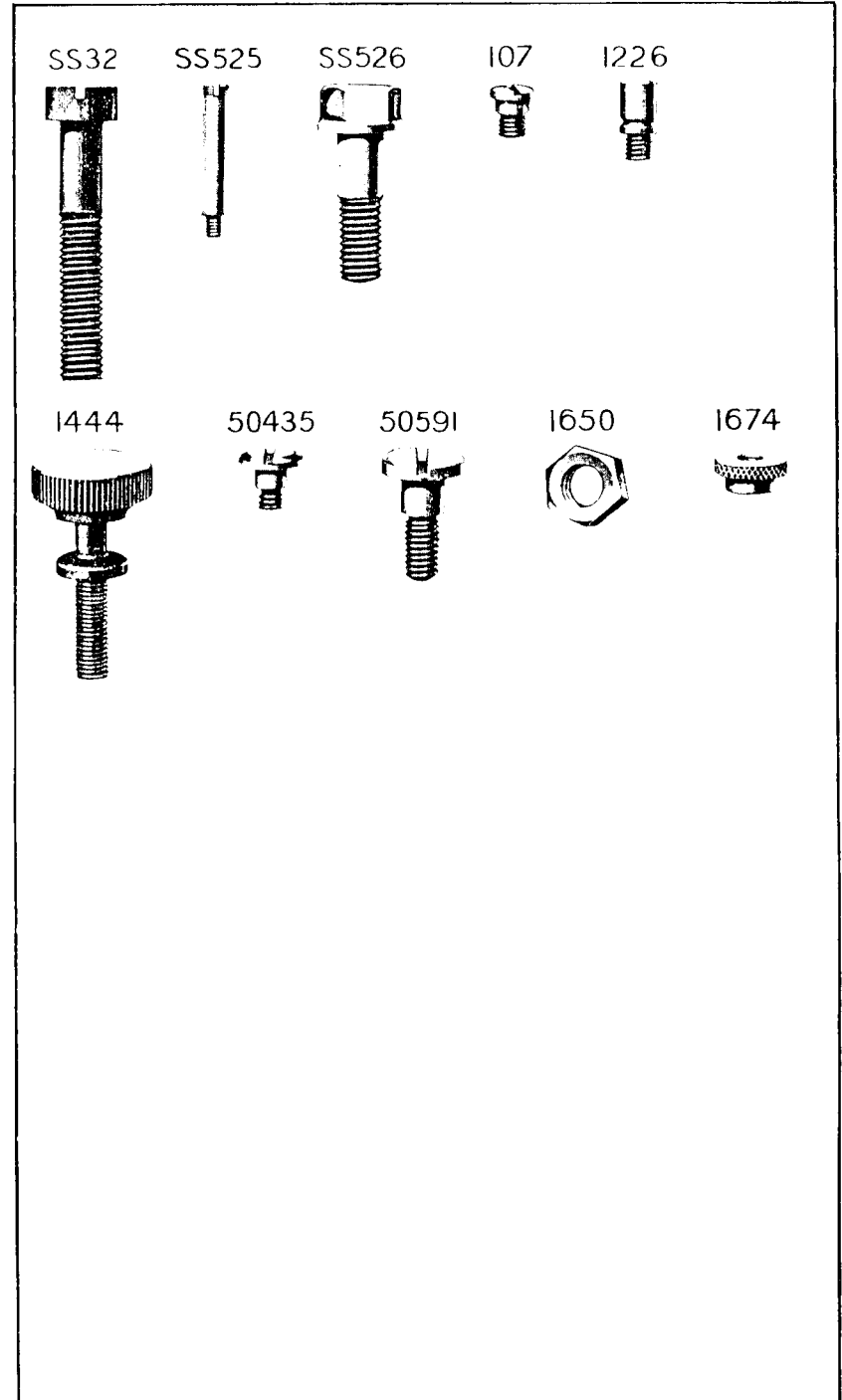
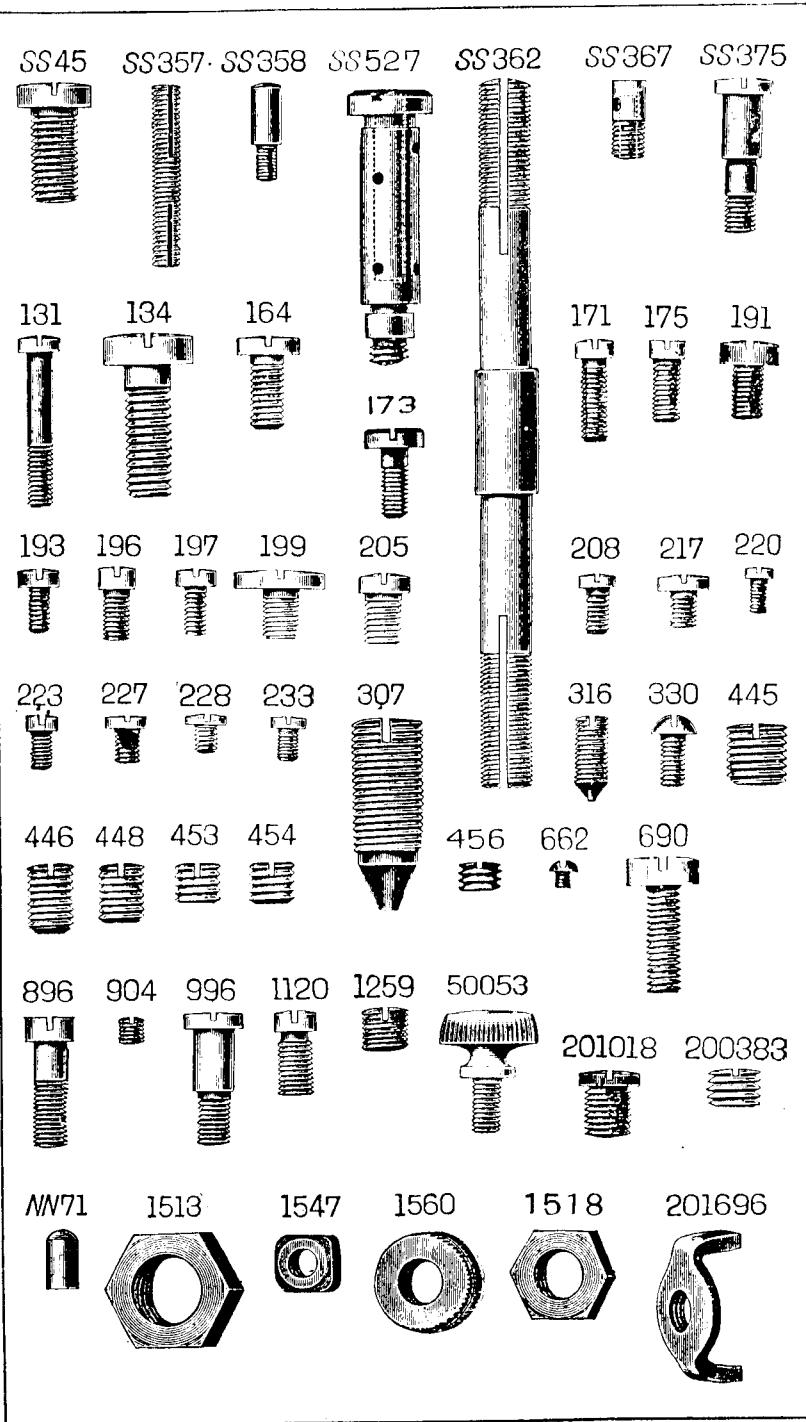

95626

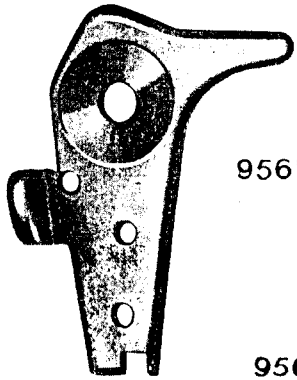

95625

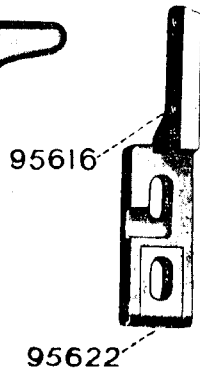

95615

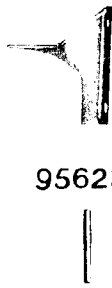

95624



95616

95623

SS 518

95628

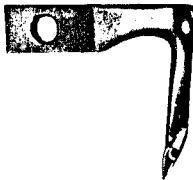

95632



95630



92314

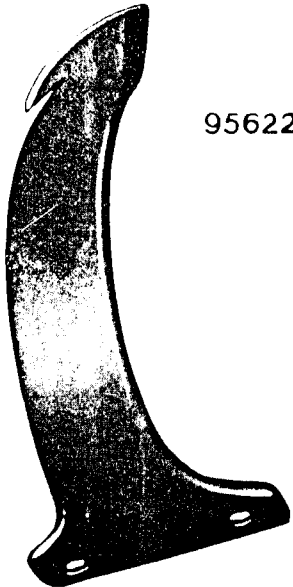

92364

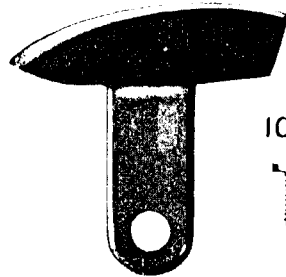

95622

1094



225258

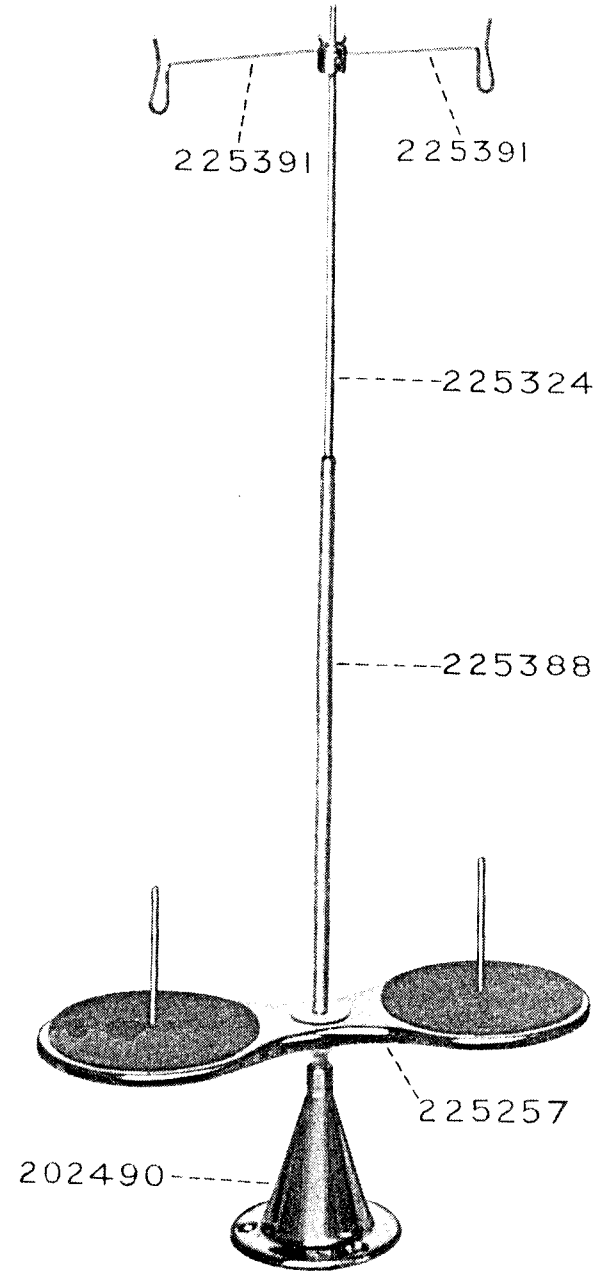

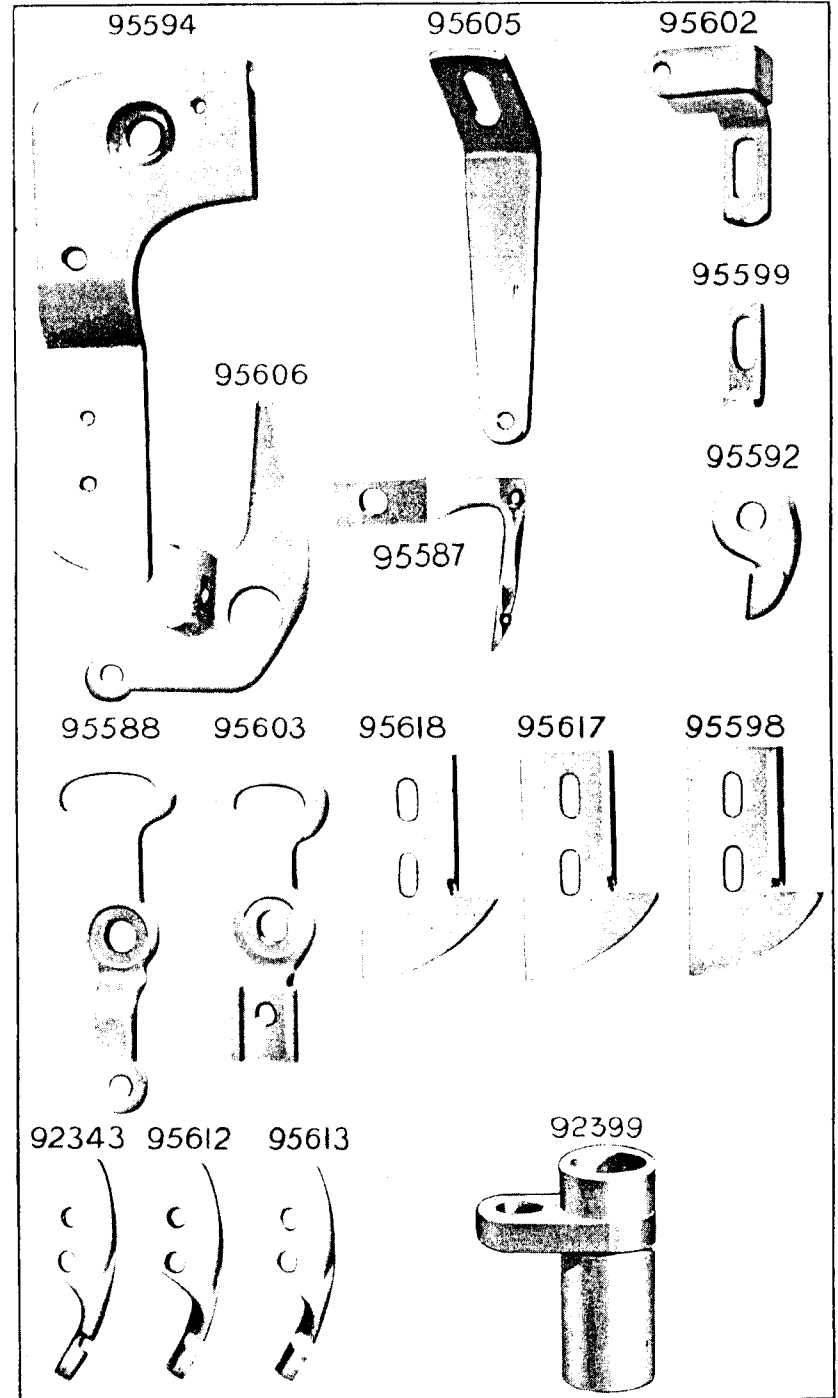
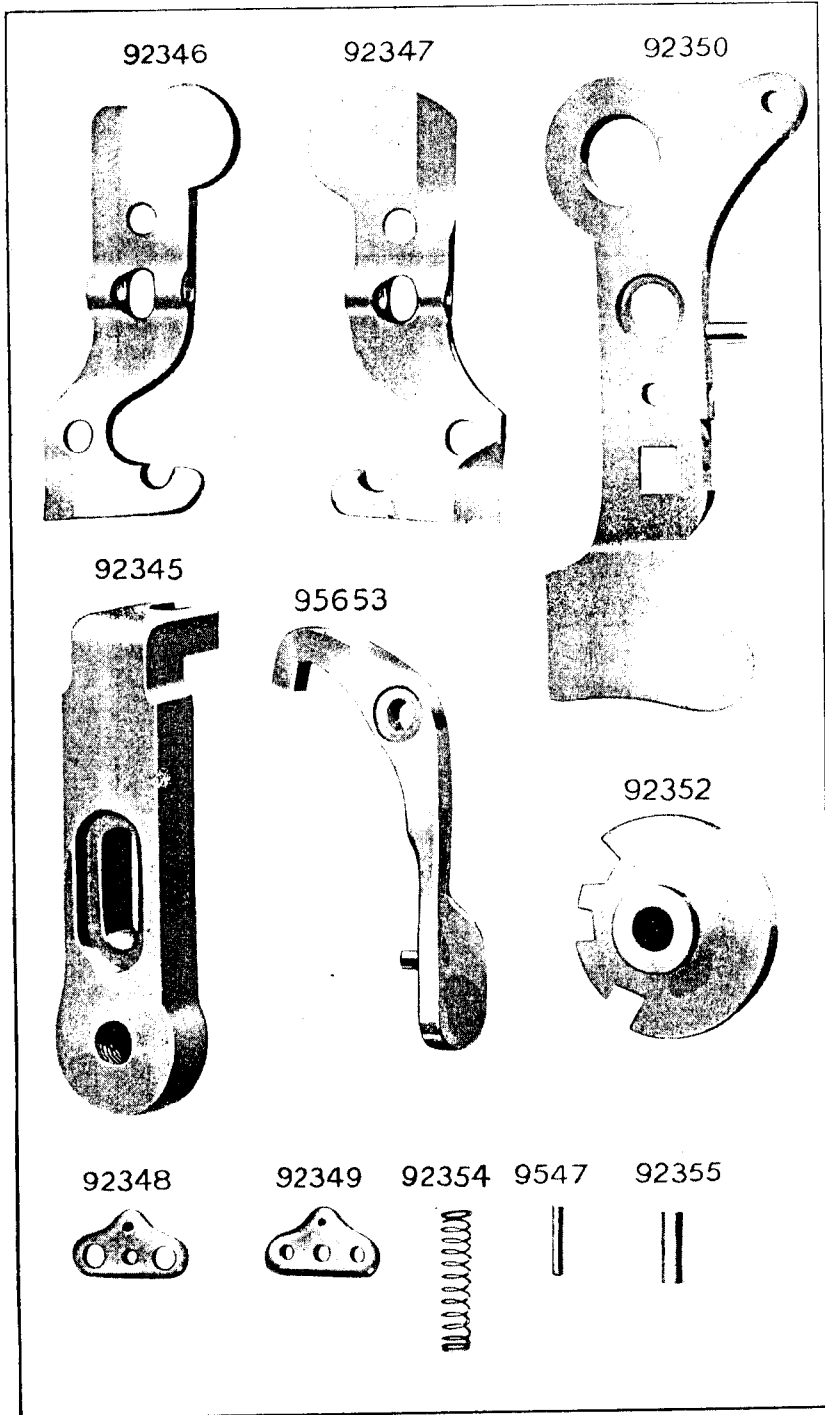

## CONTENTS

	Page
Accessories	39
Foot Lever	40
Mock Seam Swing Guide	39
Parts Complete for No. 46K50 Machine	29
"    Special to No. 46K51 Machine	35
"    "    "    46K52	36
Thread Unwinder	40



No.	Plate						
92382	1777	<b>Feed Bracket Gear</b> (16 teeth) with 1259c	...	...	...	...	...
92383	1777	" " " (19 " ) "	1259c	...	...	...	...
92584	957	" " " (22 " ) "	1259c	...	...	...	...
92585	957	" " " (33 " ) "	1259c	...	...	...	...
92393	1777	" " " (40 " ) "	1259c	...	...	...	...
92394	1777	" " " (44 " ) "	1259c	...	...	...	...
1259c	1784	" " " Set Screw	...	...	...	...	...
<i>NOTE. - Feed Bracket Gears Nos. 92584 and 92585 are sent with this machine unless otherwise specified on order.</i>							
<i>Gears 92394 and 92590 give 1½ stitches per inch.</i>							
"	92393	"	92590	"	5½	"	"
"	92585	"	92590	"	7	"	"
"	92585	"	92591	"	9	"	"
"	92581	"	92590	"	11	"	"
"	92584	"	92591	"	13	"	"
"	92383	"	92591	"	15	"	"
"	92382	"	92591	"	18	"	"
92571	1778	<b>Feed Bracket Oil Tube</b>	...	...	...	...	...
92586	956	" " Shaft	...	...	...	...	...
92587	956	" " Collar with 1258c	...	...	...	...	...
1258c	956	" " Set Screw	...	...	...	...	...
92588	956	" " Washer	...	...	...	...	...
92392	...	<b>Feed Bracket, complete, Nos. 190d, 92583, 92586, 92587, 92592 and 92593</b>	...	...	...	...	...
*92338	1779	<b>Feed Bracket (front)</b>	...	...	...	...	...
4389	1778	" " ( " ) Dowel Pin (2)	...	...	...	...	...
134d	1784	" " ( " ) Screw (2)	...	...	...	...	...
92339	...	<b>Feed Bracket (front), complete, Nos. 690f, 92338, 9560f and two 153c</b>	...	...	...	...	...
92570	1777	" " ( " ) Stud	...	...	...	...	...
199f	1784	" " ( " ) End Position Screw	...	...	...	...	...
316c	1784	" " ( " ) Raising Set Screw	...	...	...	...	...
445c	1784	" " ( " ) Set Screw	...	...	...	...	...
92340	1783	" " ( " ) Thread Guide (front)	...	...	...	...	...
193f	1784	" " ( " ) " " ( " ) Screw	...	...	...	...	...
92341	1783	" " ( " ) " " (centre)	...	...	...	...	...
330d	1784	" " ( " ) " " ( " ) Screw	...	...	...	...	...
92342	1783	" " ( " ) " " (back)	...	...	...	...	...
330d	1784	" " ( " ) " " ( " ) Screw	...	...	...	...	...
92589	956	<b>Feed Shaft (upright)</b>	...	...	...	...	...
92590	957	" " ( " ) Gear (60 teeth) with 1036c	...	...	...	...	...
92591	957	" " ( " ) " (75 " ) " 1036c	...	...	...	...	...
1036c	956	" " ( " ) Set Screw	...	...	...	...	...
92592	957	" Spiral with two 465c	...	...	...	...	...
465c	956	" Set Screw	...	...	...	...	...
92593	957	" Wheel with 1259c	...	...	...	...	...
1259c	1784	" Set Screw	...	...	...	...	...

No.	Plate						
92507	1775	<b>Feeding Disc</b> (front, coarse)	...	...	...	...	...
95629	1775	" " ( " fine)	...	...	...	...	...
92508	1775	" " (back, coarse) with 451c	...	...	...	...	...
95621	1776	" " ( " fine) with 451c	...	...	...	...	...
451c	1784	" " ( " ) Set Screw	...	...	...	...	...
<i>NOTE. Nos. 92507 and 92508 are supplied with this machine, unless fine feeding discs are specified on order.</i>							
92343	2437	<b>Feeding Disc</b> (back) Edge Guide	...	...	...	...	...
92362	1777	" " ( " ) " " Bracket	...	...	...	...	...
205f	1784	" " ( " ) " " Screw (2)	...	...	...	...	...
220d	1784	" " ( " ) " " Screw	...	...	...	...	...
92344	...	<b>Feeding Disc (back) Edge Guide, complete, Nos. 92343, 92362 and two 220d</b>	...	...	...	...	...
92344	1808	<b>Feeding Disc Stripper</b> (for back feeding disc)	...	...	...	...	...
330d	1784	" " " Screw (for back feeding disc) (2)	...	...	...	...	...
*92357	...	<b>Head</b> (of Machine) with 1510f and two 15105	...	...	...	...	...
SS32f	1785	" ( " " ) Binding Screw (4)	...	...	...	...	...
95587	2437	<b>Looper</b>	...	...	...	...	...
193f	1784	" Binding Screw	...	...	...	...	...
92536	1778	" Holder	...	...	...	...	...
92538	1778	" " Connecting Link	...	...	...	...	...
996c	1784	" " " " Hinge Screw	...	...	...	...	...
SS375c	1784	" " " " " " (eccentric)	...	...	...	...	...
901c	1784	" " " " " " Set Screw	...	...	...	...	...
1517c	1784	" " " " " " Nut for SS375c and 996c	...	...	...	...	...
92537	1778	" " Stud	...	...	...	...	...
453c	1784	" " " Set Screw	...	...	...	...	...
95588	2437	" Thread Controller Thread Guide (adjustable)	...	...	...	...	...
107b	1785	" " " " " Hinge Screw	...	...	...	...	...
50053b	1784	" " " " " Thumb Screw	...	...	...	...	...
92325	1777	<b>Loop Spreader</b>	...	...	...	...	...
175f	1784	" " Binding Screw	...	...	...	...	...
95589	1783	" " Holder with 901c	...	...	...	...	...
92543	1773	" " " Crank Connecting Rod with 92544 and two 896d	...	...	...	...	...
*92544	...	" " " " " Cap	...	...	...	...	...
896d	1784	" " " " " " Screw	...	...	...	...	...
95590	1783	" " " " " Stud	...	...	...	...	...
1120c	1784	" " " " " Set Screw	...	...	...	...	...
SS527c	1784	" " " " " Hinge Screw Stud	...	...	...	...	...
1650c	1785	" " " " " Nut	...	...	...	...	...
SS367c	1784	" " " " " Oil Feed Screw	...	...	...	...	...
92399	2437	" " " Rocking Bracket	...	...	...	...	...
92542	1778	" " " " " Stud	...	...	...	...	...
453c	1784	" " " " " Set Screw	...	...	...	...	...

1/50  
1/50

1/50

No.	Plate						
95591	-	<b>Machine Base</b> ... ..					
525b	1778	"	Hinge Bolt	...	...	...	...
1518e	1784	"	"	"	Nut	...	...
2807	1778	"	"	"	"	Washer	...
8294	1778	"	"	"	"	Connection	...
8295		"	"	"	"	Hinge Pin	...
8306b		"	"	"	"	Nos. 525b, 8294 and 8295	...
8292b	1778	<b>Machine Hinge</b> , complete, Nos. 1518e, 2807 and 8306 (2)					...
95385	1774	<b>Needle Bar</b> ... ..					
92559	1777	"	"	Bush	...	...	...
446e	1784	"	"	"	"	Set Screw	...
95386	1774	"	"	"	"	Clamp	...
193f	1784	"	"	"	"	Binding Screw	...
95387	1774	"	"	"	"	"	Washer
92549	1777	"	"	"	"	Connection with 175f and 223e	...
175f	1784	"	"	"	"	Binding Screw	...
42055	1777	"	"	"	"	Link	...
40247	1777	"	"	"	"	"	Stud (2)
223e	1784	"	"	"	"	"	Set Screw
92553	1777	"	"	"	"	Crank Connecting Rod with 92554 and two 171e	...
*92554	-	"	"	"	"	"	Cap
171e	1784	"	"	"	"	"	Screw
40247	1777	"	"	"	"	"	Stud
223e	1784	"	"	"	"	"	Set Screw
197d	1784	"	"	"	"	"	Needle Set Screw
92551	1777	"	"	"	"	Rock Lever with 191e and two 223e	...
191e	1784	"	"	"	"	"	Set Screw
92552	1777	"	"	"	"	"	Stud
95592	2437	"	"	"	"	Thread Guide	...
1226d	1785	"	"	"	"	"	Screw
95593	-	<b>Needle Bar</b> , complete, Nos. 193f, 197d, 1226d, 95385 to 95387 and 95592					...
95594	2437	<b>Needle Guide</b> ... ..					
95630	1808	"	"	"	"	Chaining Finger	...
95631	1808	"	"	"	"	"	Holder (hinged)
208b	1784	"	"	"	"	"	Adjusting Screw
95626	1808	"	"	"	"	"	Bracket (hinged)
50435b	1785	"	"	"	"	"	Hinge Screw
19054	1783	"	"	"	"	"	"
						"	Spring Washer
95633	-	"	"	"	"	"	(hinged) complete, Nos. 228b, 95624, 95626, 95630, 95632, two each 208b and 662b

No.	Plate						
95622	1808	<b>Needle Guide Chaining Finger Holder Hinge Block</b> ... ..					
208b	1784	"	"	"	"	"	"
95623	1808	"	"	"	"	"	"
95624	1808	"	"	"	"	"	"
228b	1784	"	"	"	"	"	"
95632	1808	"	"	"	"	"	"
							(hinged) complete, Nos. 95622, 95623 and 95631
662b	1784	"	"	"	"	"	Screw
95598	2437	"	"	"	"	"	Edge Guide
233b	1784	"	"	"	"	"	Screw (2)
173c	1784	"	"	"	"	"	Position Screw
95599	2437	"	"	"	"	"	Stop
233b	1784	"	"	"	"	"	Screw
95634	-	<b>Needle Guide</b> , complete, Nos. 19054, 50435b, 95594, 95598, 95599, 95633 and three 233b					...
SS518k	1808	<b>Needle Guide Binding Screw</b> ... ..					
95601	1779	"	"	"	"	"	Support Bracket (adjustable)
690f	1784	"	"	"	"	"	Binding Screw
95602	2437	<b>Needle Thread Controller Thread Guide</b> (adjustable)					...
95603	2437	"	"	"	"	"	Carrier
407b	1785	"	"	"	"	"	"
50053b	1784	"	"	"	"	"	"
							Flange
228d	1784	"	"	"	"	"	"
							Screw
95604	-	<b>Needle Thread Controller Thread Guide</b> , complete, Nos. 228d, 95602 and 95603					...
95605	2437	<b>Needle Thread Guide</b> ... ..					
193d	1784	"	"	"	"	"	Screw
707f	1778	"	"	"	"	"	Washer
2102	1778	<b>Tension Disc</b> ... ..					
84113	1783	"	"	"	"	"	Washer (Leather)
95463	1783	"	"	"	"	"	Release
95465	1783	"	"	"	"	"	Rod
227c	1784	"	"	"	"	"	Set Screw
95464	1783	"	"	"	"	"	Spring
SS362e	1784	"	"	"	"	"	Screw Stud
1560d	1784	"	"	"	"	"	Nut
131e	1784	"	"	"	"	"	Set Screw
92563	1778	"	"	"	"	"	Spring



No.	Plate						
95606	2437	<b>Thread Controller</b>	...	...	...	...	...
217f	1784	"	"	Screw	...	...	...
95466	1783	<b>Thread Guide</b> (for Cover Plate)	...	...	...	...	...
217f	1784	"	"	( " " " ) Screw	...	...	...
92345	2436	<b>Uncurling Guide Adjusting Bracket</b>	...	...	...	...	...
1444b	1785	"	"	"	Adjusting Screw	...	...
50591b	1785	"	"	"	Locking Screw	...	...
92346	2436	"	"	"	Plate (front)	...	...
92347	2436	"	"	"	(back)	...	...
SS358b	1784	"	"	"	Guide Screw	...	...
NN71b	1784	"	"	"	"	Nut	...
SS525b	1785	"	"	"	"	Hinge Screw Stud	...
92348	2436	"	"	"	"	"	Bracket (right)
92349	2436	"	"	"	"	"	Bracket (left)
9547	2436	"	"	"	"	"	Bracket Pin
220b	1784	"	"	"	"	"	Bracket Screw
SS357b	1784	"	"	"	"	"	Screw Stud
220b	1784	"	"	"	"	"	Set Screw
1674a	1785	"	"	"	"	"	Thumb Nut
92398	1778	"	"	"	"	"	Spring
SS45f	1784	"	"	"	"	"	Binding Screw
92350	2436	"	"	"	"	"	Body with 92355
92351	1780	"	"	"	"	"	Bracket
92352	2436	"	"	"	"	"	Position Disc
SS526k	1785	"	"	"	"	"	Screw
95653	2436	"	"	"	"	"	Lever with 92355
50435b	1785	"	"	"	"	"	Hinge Screw
92354	2436	"	"	"	"	"	Spring
92355	2436	"	"	"	"	"	Pin
92356	1780	<b>Uncurling Guide</b> (adjustable), complete, Nos. SS45f, NN71b, SS357b, SS358b, SS526k, 1444b, 50435b, 50591b, 92345 to 92352, 92351, 92398, 95653, two each SS525b, 1674a, 9547 and three 220b	...	...	...	...	...
*15404	--	<b>Trade Mark</b>	...	...	...	...	...
15405	--	"	"	Rivet	...	...	...

## Parts Special to No. 46K51 Machine

**High Speed, for Power; Two-Thread Chain Stitch; Positive Feed from right to left, both Feeding Discs positively driven. For Seaming Knit Goods and Hosiery.**

This Machine is the same as No. 46K50, with the following exceptions:

No.	Plate						
95369	1778	<b>Feed Bracket</b> (front) Bush	...	...	...	...	...
445c	1784	"	"	( " " )	"	Set Screw	...

*NOTE: Feed Bracket Gear, Nos. 92581 and 92585 are sent with this machine unless otherwise specified on order.*

*Gears 92391 and 95370 give 1½ stitches per inch.*

"	92393	"	95370	"	5½	"	"	"
"	92585	"	95370	"	7	"	"	"
"	92585	"	95371	"	9	"	"	"
"	92581	"	95370	"	11	"	"	"
"	92581	"	95371	"	13	"	"	"
"	92383	"	95371	"	15	"	"	"
"	92382	"	95371	"	18	"	"	"

95370	1774	<b>Feed Shaft (upright) Gear</b> (60 teeth) with 1036c and 95372	...	...	...	...	...
95371	1774	"	"	( " " )	"	75	"
95372	1774	"	"	( " " )	"	"	1036c
							95372
							Driving Pin

95607	1783	<b>Feeding Disc</b> (front, coarse) with 15K <sup>AL</sup>	...	...	...	...	...	11/32
95620	1776	"	"	( " " )	"	fine	with 45K <sup>AL</sup>	1/20
454c	1784	"	"	( " " )	"	Set Screw	...	...
92508	1775	"	"	(back, coarse) with 15K <sup>AL</sup>	...	...	...	11/32
95621	1776	"	"	( " " )	"	fine	with 15K <sup>AL</sup>	11/32

*NOTE: Nos. 92508 and 95607 are supplied with this machine, unless fine feeding discs are specified on order.*

95376	1776	<b>Feeding Disc Gear</b>	...	...	...	...	...	...
95377	1773	"	"	Shaft	...	...	...	...
92203	1783	"	"	"	Collar with 156 <sup>AL</sup>	...	...	...
456c	1784	"	"	"	"	Set Screw	...	11/32
95378	1776	"	"	"	"	Gear with two 196K <sup>AL</sup>	...	5/32
for 196K <sup>AL</sup>	1784	"	"	"	"	Set Screw	...	...
92364	1808	"	"	"	"	Stripper (for front feeding disc)	...	...
1094d	1808	"	"	"	"	Screw (for front feeding disc)	...	...

*95608		<b>Head</b> (of machine) with 15404 and two 15405	...	...	...	...	...
95609		<b>Machine Base</b>	...	...	...	...	...

## Parts Special to No. 46K52 Machine

High Speed, for Power; Two-Thread Chain Stitch; Positive Feed from right to left, both Feeding Discs positively driven. For Fine Hosiery Seaming and Mock Seaming.

This Machine is the same as No. 46K50, with the following exceptions:

No.	Plate						
92381	1773	<b>Balance Wheel Crank Shaft</b>	...	...	...	...	...
95369	1778	<b>Feed Bracket (front) Bush</b>	...	...	...	...	...
445c	1784	" " ( " ) " Set Screw	...	...	...	...	...
95610	1783	<b>Feed Bracket Gear (14 teeth) with 1259c</b>	...	...	...	...	...
95611	1783	" " " (15 " ) " 1259c	...	...	...	...	...
92382	1777	" " " (16 " ) " 1259c	...	...	...	...	...
92383	1777	" " " (19 " ) " 1259c	...	...	...	...	...
92584	957	" " " (22 " ) " 1259c	...	...	...	...	...
NOTE: Feed Bracket Gears Nos. 92382, 92383 and 92584 are sent with this machine unless other size specified on order.							
<i>Gears 92581 and 95371 give 13 stitches per inch.</i>							
"	92383	"	95371	"	15	"	"
"	92382	"	95371	"	18	"	"
"	95611	"	95371	"	20	"	"
"	95610	"	95371	"	22	"	"
95371	1774	<b>Feed Shaft (upright) Gear (75 teeth) with 1036c and 95372...</b>	...	...	...	...	...
95372	1774	" " ( " ) " Driving Pin	...	...	...	...	...
95620	1776	<b>Feeding Disc (front, fine) with 156<sup>AL</sup></b>	...	...	...	...	...
454c	1784	" " ( " ) Set Screw	...	...	...	...	...
95621	1776	" " (back, fine) with 156 <sup>AL</sup>	...	...	...	...	...
95612	2437	" " ( " ) Edge Guide (.04" thick)	...	...	...	...	...
95613	2437	" " ( " ) " " (.05" thick)	...	...	...	...	...
95614	---	<b>Feeding Disc (back) Edge Guide, complete, Nos. 92362, 95613 and two 220d</b>	...	...	...	...	...
95376	1776	<b>Feeding Disc Gear</b>	...	...	...	...	...
95377	1773	" " Shaft	...	...	...	...	...
92203	1783	" " " Collar with 156 <sup>AL</sup>	...	...	...	...	...
456 <sup>AL</sup>	1784	" " " " Set Screw	...	...	...	...	...
95378	1776	" " " Gear with two 196f	...	...	...	...	...
196f	1784	" " " " Set Screw	...	...	...	...	...
92364	1808	" " Stripper (for front feeding disc)	...	...	...	...	...
1094d	1808	" " " Screw (for front feeding disc)	...	...	...	...	...

## PARTS SPECIAL TO No. 46K52 MACHINE

No.	Plate						
*95608		<b>Head (of machine) with 15404 and two 15405</b>	...	...	...	...	...
95628	1808	<b>Looper</b>	...	...	...	...	...
92546	1777	<b>Loop Spreader</b>	...	...	...	...	...
95609		<b>Machine Base</b>	...	...	...	...	...
95615	1808	<b>Needle Guide Chaining Finger</b>	...	...	...	...	...
95616	1808	" " " " Holder (hinged)	...	...	...	...	...
95627		" " " " Bracket (hinged), complete, Nos. 228b, 95615, 95624 to 95626, two each 208b and 662b	...	...	...	...	...
95625	1808	" " " " Holder (hinged), complete, Nos. 95616, 95622 and 95623	...	...	...	...	...
95617	2437	" " Edge Guide (.04" thick)	...	...	...	...	...
95618	2437	" " " " (.05" thick)	...	...	...	...	...
95619		<b>Needle Guide, complete, Nos. 19054, 50135b, 95594, 95599, 95618, 95627 and three 233b</b>	...	...	...	...	...
95635		<b>Needle Thread Guide (adjustable)</b>	...	...	...	...	...

n/s

n/s

n/s

1/32

## Accessories

No.	Plate	
SS563	1773	Bench Screw $3\frac{21}{32}$ " long, for $1\frac{1}{8}$ " Table (2) ... ..
95655		" " Spring (2) ... ..
9842		" " Washer (2) ... ..
95654		Machine Base Pad (felt) $11\frac{1}{8}$ " x $1\frac{1}{4}$ " x $\frac{3}{4}$ " (2) ... ..
165-21		Needles (6), two each sizes 19, 21 and 22, for 46K50 and 46K51 Machines
215-21		Needles (6), three each sizes 11 and 14, for 46K52 Machine ...
36569	1355	Oiler ... ..
25537	1355	Screw Driver ... ..
86405	1355	Tweezers ... ..
8009	1780	Wrench for 1677 ... ..

## Mock Seam Swing Guide

FOR LADIES' STOCKINGS

for use with No. 46K52 Machine.

No.	Plate	
86528		Base ... ..
		" Screw (Wood) 1" No. 12 ... ..
86529		Blade (broad) ... ..
86530		" (narrow) ... ..
86531		" Bracket with two each 423c, 1520r and 86533 ... ..
1535d		" " Height Adjusting Thumb Nut ... ..
86532		" " Spindle ... ..
92587	956	" " " Collar ... ..
458AL		" " " Set Screw ... ..
423c		" " Swing Adjusting Screw ... ..
1520r		" " " " " Nut ... ..
86533		" Position Pin ... ..
SS192d		" Thumb Screw ... ..
86534		Hinge Bracket with SS367d and two 458AL ... ..
86535		" " Spindle ... ..
50145c		" " " Position Screw ... ..
86536		" " Spring ... ..
SS367d	1784	" " " Stop Screw ... ..
86573		Stop ... ..
86527		<b>Mock Seam Swing Guide</b> , complete, Nos. 1535d, 50145c, 86528 to 86532, 86534 to 86536, 86573, 92587, two SS192d, and four Wood Screws 1" No. 12 ... ..

## Thread Unwinder

For Two Spools of Thread.

No.	Plate						
225257	2213	<b>Spool Rest</b> with 201018c	...	...	...	...	...
150203		" " Cushion (felt)	...	...	...	...	...
225388	2213	" " Rod	...	...	...	...	...
200383c	1784	" " " Set Screw	...	...	...	...	...
201018c	1784	" " Set Screw	...	...	...	...	...
202490	2213	" Stand with 200383c	...	...	...	...	...
225391	2213	<b>Thread Guide</b>	...	...	...	...	...
201696j	1784	" " Lock Nut	...	...	...	...	...
225326	-	" " Position Cup	...	...	...	...	...
225324	2213	" " Rod with 208c and 225322	...	...	...	...	...
208c	1784	" " " Screw	...	...	...	...	...
225322	-	" " " Washer	...	...	...	...	...
225258	2213	<b>Thread Unwinder</b> , complete, Nos. 201696j, 202490, 225257, 225324, 225326, 225388, two each 150203, 225391 and three Wood Screws $\frac{3}{4}$ " No. 12	...	...	...	...	...
27739	...	<b>Thread Cone</b> (woody) for large cones	...	...	...	...	...
225390	-	" " Holder for inverted cones	...	...	...	...	...

*NOTE: Nos. 27739 and 225390 are used with, but not included in 225258.*

## Foot Lever

The undernoted parts are included in the equipment of each Machine.

No.	Plate						
91296	915	<b>Foot Lever</b>	...	...	...	...	...
92567	915	" " Bracket	...	...	...	...	...
91298	1778	" " " Hinge Pin	...	...	...	...	...
		" " " Screw (Wood) $1\frac{1}{4}$ " No. 15	...	...	...	...	...
92578	915	<b>Foot Lever</b> , complete, Nos. 92567, two each 91296, 91298 and five Wood Screws $1\frac{1}{4}$ " No. 15	...	...	...	...	...
39569	-	" " Chain, 45" long, with 39575 and 39576	...	...	...	...	...
39575	1775	" " " Hook (lower)	...	...	...	...	...
39576	1775	" " " " (upper)	...	...	...	...	...
92568	-	<b>Combination Feeding Disc Opener and Driving Foot Levers</b> , complete, Nos. 92578 and two 39569	...	...	...	...	...