

SINGER
44-40 & 44-84

LIST OF PARTS



MACHINES Nos. 44-40 and 44-84

THE SINGER MANUFACTURING COMPANY

INDEX

	PAGE
ATTACHMENTS AND ACCESSORIES.....	27
BOBBIN WINDER No. 27588.....	28
" " " 225436.....	29
GUIDE.....	27
KNEE LIFTER PARTS.....	30
MACHINE No. 44-40.....	7
" " 44-84.....	17
NUMERICAL LIST OF PARTS.....	33
TAPE GUIDE.....	27
" HOLDER.....	28
THREAD UNWINDER.....	31

INSTRUCTIONS FOR ORDERING

In ordering from this list, use **ONLY** the PART number in the **FIRST** column.

The number stamped on a Sewing Machine part is in every case the number of the single part only.

Every combination of parts sent out as such has its specific number, which, although not stamped on the parts, must be used when ordering the combination.

Each number always indicates the **SAME PART** in whatever list it appears, or for whatever machine.

The letters after some of the numbers indicate the style of finish only, as follows:

- A. Hardened, Polished and Plated.
- B. Polished and Plated.
- C. Hardened only.
- D. Polished only.
- E. Soft, not Polished.
- F. Hardened and Polished.
- G.
- H. Blued.
- J. Plated only.
- K. Hardened and Plated.
- L. Brass or Gilt
- M. Oxidized.
- P. Japanned.
- R. Parkerized.

These letters **MUST BE USED** when they appear in the list, and **AFTER** the number as in the list.

In this series

- 1 to 1500 and 50001 to 51500 are Screw Numbers.
- 1501 to 1800 are Nut Numbers.
- 1801 to 2000 are Roller Numbers.
- 2001 to 50000 and 52001 and upward are numbers of Machine Parts.

The figures in the second column refer only to the plates illustrating the parts, and are **NOT TO BE USED** in ordering

Parts marked with an asterisk (*) are furnished only when repairs are made at factory.

When ordering parts which differ as to GAUGE (the distance between seams) the GAUGE as well as the NUMBER MUST BE GIVEN on order.

NO.	PLATE	NAME
20197	2578	Crank Connecting Rod with 20198 and two 896E.....
*20198	—	Crank Connecting Rod Cap.....
	896E 1221	" " " " Screw.....
	908c 1221	" " " " Hinge Screw.....
	1619E 2591	" " " " " Nut
24918	—	Face Plate.....
24919	2579	Face Plate complete, Nos. 185c, 9544, 9545, 19327, 19337, 24918 and two 9543
19327	1220	Face Plate Thread Guard with 12152....
12152	1220	" " " " Rivet.....
	286D 783	" " Thumb Screw.....
19111	1208	Feed Bar.....
	313c 783	" " Screw Centre.....
56843	—	" " " " 313c with 1519J....
	1519J 783	" " " " Nut.....
12197	2583	" Cam and Feed Lifting Eccentric with 446c.....
	446c 783	Feed Cam and Feed Lifting Eccentric Set Screw.....
3033	1145	Feed Connecting Link.....
	375c 782	" " " " Hinge Screw.....
	1518E 783	" " " " " Nut.
24592	2586	" Dog with 19118, for $\frac{3}{32}$ in. to $\frac{1}{4}$ in. gauge.....
24594	2586	Feed Dog with 19118, for $\frac{3}{16}$ in. to $\frac{1}{4}$ in. gauge.....
	191c 1221	Feed Dog Screw.....
19116	1220	" " Spring.....
19117	1220	" " " " Hook for 19120.....
19118	1220	" " " " " 24592 and 24594
12123	2580	" Forked Connection.....
	375c 782	" " " " Hinge Screw....
	1518E 783	" " " " " " Nut
16504	2578	" Lifting Rock Shaft.....
19236	—	Feed Lifting Rock Shaft complete, Nos. 16504, 16556 and 19120.....
16556	1208	Feed Lifting Rock Shaft Crank (back) with 462c.....
2049	1220	Feed Lifting Rock Shaft Crank (back) Pin.....
	462c 1221	Feed Lifting Rock Shaft Crank (back) Set Screw.....
19120	1208	Feed Lifting Rock Shaft Crank (front) with 157J, 19117, 19121 and 19122....
	157J 782	Feed Lifting Rock Shaft Crank (front) Clamping Screw.....

**LIST OF PARTS COMPLETE
FOR
MACHINE No. 44-40**

**FOR TWO-ROW STITCHING IN LIGHT AND MEDIUM LEATHER.
HAS MECHANISM FOR THROWING THE LEFT HAND
NEEDLE OUT OF ACTION. TWO NEEDLES, TWO SHUTTLES.
GAUGES FROM $\frac{3}{32}$ IN. TO $\frac{1}{4}$ IN. FITTED WITH REGU-
LATING SCREWS IN THE ARM BRACKET TO REGULATE
THE ACTION OF THE BELL CRANK THAT ACTUATES THE
NEEDLE BAR LOCKING PIN. KNEE LIFTER.**

NO.	PLATE	NAME
*24916	—	Arm with 11104.....
8582	1220	" Dowel Pin.....
12453	1220	" Oil Tube for intermediate bearing...
12454	1220	" " " with 29599, for oiling 12409
11119	1220	" " " " " " " 19156
24131	2582	" " " " " " " 12197
29599	2582	" " " Packing (felt).....
748E	782	" Screw (back).....
868E	1221	" " (front).....
16511	2578	" Shaft.....
*11104	—	" " Bushing (front).....
12357	2583	" " Flanged Bushing (back).....
448c	783	" " " " " " Set Screw.....
144D	782	Arm Shaft Screw.....
12480	2583	" Side Cap.....
219D	2591	" " " Screw.....
12193	2579	" " Cover.....
286D	783	" " " Thumb Screw.....
2415	—	" Spool Bracket.....
15063	2579	" " " 2415 with two 12403..
145D	782	" " " Screw.....
12403	1220	" " " Spool Pin and Thread Eyelet.....
11241	2583	Arm Spool Bracket Spool Pin Washer (cloth).....
24296	2579	Balance Wheel (power) light rim, $2\frac{3}{8}$ in. pulley, with two 448c.....
24297	2579	Balance Wheel Oil Cover.....
210D	2591	" " " " " Screw.....
448c	783	" " " Set Screw.....
*24917	—	Bed.....

NO.	PLATE	NAME
19121	1208	Feed Lifting Rock Shaft Crank (front) Roller.....
19122	1208	Feed Lifting Rock Shaft Crank (front) Roller Pin.....
43976	2578	Feed Lifting Rock Shaft Crank Connect- ing Rod with 43977 and two 966E.....
*43977	—	Feed Lifting Rock Shaft Crank Connect- ing Rod Cap.....
966E	2591	Feed Lifting Rock Shaft Crank Connect- ing Rod Cap Screw.....
375c	782	Feed Lifting Rock Shaft Crank Connect- ing Rod Hinge Screw.....
1518E	783	Feed Lifting Rock Shaft Crank Connect- ing Rod Hinge Screw Nut.....
307c	783	Feed Lifting Rock Shaft Screw Centre... 56814 " " " " " " " 307c with 1513J.....
1513J	783	Feed Lifting Rock Shaft Screw Centre Nut
3039	2583	" Regulator.....
1128E	2591	" " Hinge Screw.....
818D	783	" " Thumb Screw.....
16506	2578	" Rock Shaft.....
24376	—	Feed Rock Shaft complete, Nos. 16506 and 29633.....
29633	2583	Feed Rock Shaft Crank with 157J.....
157J	782	" " " " Clamping Screw.
307c	783	" " " Screw Centre.....
56814	—	" " " " " " 307c with 1513J.....
1513J	783	Feed Rock Shaft Screw Centre Nut.....
*62589	2580	Needle Bar, for left hand needle, with 4766
*62594	2580	" " " right hand needle, with 620c
62595	2580	Needle Bar complete, for $\frac{3}{32}$ in. to $\frac{9}{64}$ in. gauge, Nos. 665D, 930E, 19452, 19460, 50257E, 62589, 62591, 62593, 62594, 62596 and two 207F.....
62597	—	Needle Bar complete, for $\frac{5}{32}$ in. to $\frac{11}{64}$ in. gauge, Nos. 665D, 930E, 19452, 19460, 50257E, 62589, 62591, 62593, 62594, 62598 and two 207F.....
62599	—	Needle Bar complete, for $\frac{3}{16}$ in. gauge and above, Nos. 665D, 930E, 19452, 19460, 24938, 50257E, 62589, 62591, 62593, 62594 and two 207F.....
62591	2583	Needle Bar Collar.....
207F	2591	" " " Screw.....
24923	2582	" " Connecting Link with 794E..

NO.	PLATE	NAME
794E	782	Needle Bar Connecting Link Adjusting Screw.....
*62592	---	Needle Bar Connecting Stud.....
62593	2583	Needle Bar Connecting Stud complete, Nos. 1904 and 62592.....
1904	2583	Needle Bar Connecting Stud Roller (roller only).....
930E	2591	Needle Bar Connecting Stud Screw (lower)
50257E	2591	" " " " " (upper)
4766	2581	" " Coupling.....
19452	2581	" " " Pin.....
24926	2581	" " " " Lever.....
24927	2581	" " " " " Hub with 207F.....
207F	2591	Needle Bar Coupling Pin Lever Hub Set Screw.....
1735H	2591	Needle Bar Coupling Pin Lever Lock Nut
19454	2581	" " " " " Shaft.....
19457	---	Needle Bar Coupling Pin Lever Shaft complete, Nos. 2273, 19454 and 19456.....
24928	2581	Needle Bar Coupling Pin Lever Shaft Bracket.....
175E	2591	Needle Bar Coupling Pin Lever Shaft Bracket Screw.....
19456	2581	Needle Bar Coupling Pin Lever Shaft Crank.....
2273	2581	Needle Bar Coupling Pin Lever Shaft Crank Pin.....
24929	2581	Needle Bar Coupling Pin Stop.....
219F	2591	" " " " " Screw.....
20188	2582	" " Crank with 858c and 1065c.....
1065C	2591	" " " Position Screw.....
858C	783	" " " Set Screw.....
931E	2591	" " Screw Bushing.....
24930	2581	" " Stop with 23548.....
24931	2581	" " " Bracket with 191F.....
24932	2581	" " " " Bar.....
435C	2591	" " " " " Set Screw.....
191F	1221	" " " " " Set Screw.....
24933	2581	" " " Collar with 175D.....
175D	2591	" " " " Clamping Screw.....
23474	2581	" " " " Washer (rawhide)
23548	2581	" " " Plug (fibre).....
25478	2581	" " " Spring.....
19460	2581	" " Thread Guide.....
665D	2591	" " " " Screw.....
24935	2580	" " Trip Lever.....

NO.	PLATE	NAME
6439	---	Needle Bar Trip Lever Chain, 36 in. to 45 in.....
NOTE: When ordering No. 6439 give length required.		
4879	2594	Needle Bar Trip Lever Chain Connecting Link.....
24936	2580	Needle Bar Trip Lever Connecting Rod
12416	1145	" " " " " " " Joint.....
76D	782	Needle Bar Trip Lever Connecting Rod Joint Hinge Screw.....
1521E	2591	Needle Bar Trip Lever Connecting Rod Lock Nut.....
9534	2581	Needle Bar Trip Lever Connecting Rod Spring.....
19256	2581	Needle Bar Trip Lever Connecting Rod Spring Collar with 187E.....
187E	2591	Needle Bar Trip Lever Connecting Rod Spring Collar Set Screw.....
6312	2581	Needle Bar Trip Lever Connecting Rod Spring Washer.....
19462	2580	Needle Bar Trip Lever Pitman.....
95D	1221	" " " " " Hinge Screw (crank end).....
90D	1221	Needle Bar Trip Lever Pitman Hinge Screw (lever end).....
145D	782	Needle Bar Trip Lever Stop Screw (left)
1528J	2591	" " " " " " " Lock Nut.....
145D	782	Needle Bar Trip Lever Stop Screw (right)
1528J	2591	" " " " " " " Lock Nut.....
24937	2592	Needle Bar Trip Lever Stop Screw Bracket
161D	2591	" " " " " " " Screw.....
4881	2594	Needle Bar Trip Lever Treadle.....
4882	2592	" " " " " Shaft.....
4883	2590	" " " " " Spring.....
4884	2594	" " " " " Stand.....
4885	2594	Needle Bar Trip Lever Treadle complete, Nos. 4879, 4881 to 4884 and two wood screws 1 in. No. 16.....
*62596	2585	Needle Clamp, for left hand needle, with 994E, for $\frac{3}{32}$ in. to $\frac{9}{64}$ in. gauge, for 62595
62598	2585	Needle Clamp, for left hand needle, with 620C and 994E, for $\frac{5}{32}$ in. to $\frac{11}{64}$ in. gauge, for 62597.....

NO.	PLATE	NAME
24938	2585	Needle Clamp, for left hand needle, with 250F and 620c, for $\frac{3}{8}$ in. gauge and above, for 62590.....
250F	2591	Needle Clamp Set Screw for 24938.....
994F	2591	" " " " " 62596 and 62598.....
620c	2591	Needle Set Screw, for right hand needle
19386	2580	Oscillating Rock Shaft.....
19387	—	Oscillating Rock Shaft complete, Nos. 4784, 12388 and 19386.....
12388	2582	Oscillating Rock Shaft Hinge Pin.....
878J	783	" " " " " Oil Hole Stop Screw.....
12459	1220	Oscillating Rock Shaft Hinge Pin Oil Hole Stop Screw Washer (leather).....
448c	783	Oscillating Rock Shaft Hinge Pin Set Screw.....
4784	2584	Oscillating Rock Shaft Oil Pad.....
19127	2578	" Shaft.....
19496	—	" " Crank.....
19388	1208	Oscillating Shaft Crank complete, Nos. 457c, 1518E, 19390 and 19496.....
2049	1220	Oscillating Shaft Crank Pin.....
457c	783	" " " Set Screw.....
19389	1208	" " " Slide Block.....
229d	782	" " " " " Cap Screw.....
12424	1208	Oscillating Shaft Crank Slide Block Cap Screw Washer.....
969c	1208	Oscillating Shaft Crank Slide Block Screw Stud.....
1518E	783	Oscillating Shaft Crank Slide Block Screw Stud Nut.....
19390	1208	Oscillating Shaft Crank Slide Block complete, Nos. 229d, 969c, 12424 and 19389
12391	2580	Presser Bar (hollow).....
12326	1145	" " Guide Bracket with 453c.....
453c	783	" " " " Set Screw.....
2062	1145	" " Lifter.....
689c	782	" " " Screw.....
1520E	783	" " " " Nut.....
12327	1145	" " Lifting and Releasing Lever Bracket.....
11167	2582	Presser Bar Spring.....
11170	1220	" " " Washer.....
24600	2586	" Foot, for plain work.....
190d	782	" " Screw.....

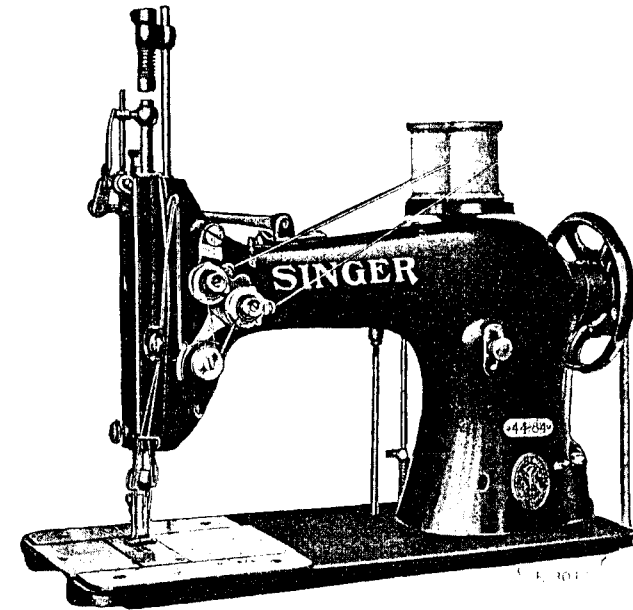
NO.	PLATE	NAME
688J	783	Pressure Regulating Thumb Screw.....
1903	2584	Roller, $1\frac{1}{4}$ in. diam., with 652d and 1528J, for 24602.....
1875	2584	Roller, $1\frac{1}{2}$ in. diam., with 634d and 1528J, for 24604.....
19197	—	Roller Arm for 24602.....
19199	—	" " " 24604.....
440F	1221	" " Adjusting Screw.....
1517J	1146	" " " " Nut.....
19200	—	" " Bracket.....
316F	1221	" " " Screw Centre.....
1517J	1146	" " " " " Nut.....
7556	2584	" " Lock Spring.....
176d	1221	" " " " Screw.....
1549J	2591	" " " " " Nut.....
24601	2584	" Needle Guard (round).....
171F	1221	" " " " Set Screw.....
24602	—	Roller Presser complete, $1\frac{1}{4}$ in. roller, for $\frac{3}{32}$ in. to $\frac{1}{4}$ in. gauge, Nos. 171F, 176d, 440F, 1549J, 1903, 7556, 19197, 19200, 24601, two 316F and three 1547J.....
24604	2584	Roller Presser complete, $1\frac{1}{2}$ in. roller, for $\frac{3}{32}$ in. to $\frac{1}{4}$ in. gauge, Nos. 171F, 176d, 440F, 1549J, 1875, 7556, 19199, 19200, 24601, two 316F and three 1547J.....
190d	782	Roller Presser Screw.....
652d	2591	" Screw for 1903.....
634d	1221	" " " 1875.....
1528J	2591	" " Nut.....
19131	1216	Shuttle (inside) Bobbin.....
62606	—	" " " Case.....
19310	1217	" " " " Latch and Position Finger.....
2521	1216	Shuttle (inside) Bobbin Case Latch and Position Finger Spring.....
592E	1216	Shuttle (inside) Bobbin Case Latch and Position Finger Stop Screw.....
19312	1217	Shuttle (inside) Bobbin Case complete, Nos. 591F, 592E, 2521, 19149, 19310 and 62606.....
19136	1216	Shuttle (inside) Body.....
591F	1216	" " Tension Regulating Screw.....
19149	1216	" " " Spring.....
19324	1217	Shuttle (inside) $1\frac{1}{8}$ in. diam., Nos. 19131, 19136 and 19312.....
19131	1216	Shuttle (outside) Bobbin.....
62608	—	" " " Case.....

NO.	PLATE	NAME
19311	1217	Shuttle (outside) Bobbin Case Latch and Position Finger.....
2521	1216	Shuttle (outside) Bobbin Case Latch and Position Finger Spring.....
592E	1216	Shuttle (outside) Bobbin Case Latch and Position Finger Stop Screw.....
19313	1217	Shuttle (outside) Bobbin Case complete, Nos. 591E, 592E, 2521, 19172, 19311 and 62608.....
19137	1216	Shuttle (outside) Body for 19325.....
19171	1217	" " " " 19326.....
591F	1216	" " Tension Regulating Screw.....
19172	1216	" " " Spring.....
19326	1217	Shuttle (outside) 1 1/4 in. diam., for 3/2 in. to 1 1/4 in. gauge, Nos. 19131, 19171 and 19313.....
19325	1217	Shuttle (outside) 1 1/4 in. diam., for 3/2 in. gauge and above, Nos. 19131, 19137 and 19313.....
19139	1208	Shuttle Driver with two 453c.....
2049	1220	" " Pin.....
453c	783	" " Set Screw.....
19315	—	" Race Body with 19316, for 19323.....
19379	—	" " " for 24013.....
19316	1213	" " Loop Separator for 19315.....
19309	1213	" " Needle Guard for 19323 and 24013.....
1053b	2591	Shuttle Race Needle Guard Screw.....
19317	1213	" " Ring (inside) for 19323 and 24013.....
19318	1213	Shuttle Race Ring (outside) for 19323 and 24013.....
2532	1220	Shuttle Race Ring Position Pin.....
2533	2585	" " " Spring.....
907b	1221	" " " Screw.....
19323	1213	Shuttle Race complete, for 3/2 in. to 5/2 in. gauge, Nos. 19309, 19315, 19317, 19318, two each 907b, 1053b, 2533 and four 2532.....
24013	2585	Shuttle Race complete, for 1 1/4 in. gauge and above, Nos. 19309, 19317, 19318, 19379, two each 907b, 1053b, 2533 and four 2532.....
145b	782	Shuttle Race Screw.....
19145	2590	" " Slide (inside).....
19146	2590	" " " (outside).....
19147	1220	" " " Friction Spring.....

NO.	PLATE	NAME
651E	1221	Shuttle Race Slide Friction Spring Screw.....
19148	2590	" " " Guide (back) with 651E and 19147.....
19185	2590	Shuttle Race Slide Guide (front) with 651E and 19147.....
691F	782	Shuttle Race Slide Guide Screw.....
2921	1146	Tension Disc.....
19191	1146	" Plate, for upper tension, with 19231.....
134b	1221	Tension Plate Screw.....
1560c	1146	" Regulating Thumb Nut.....
19192	1146	" Releaser.....
12397	1145	" Releasing Lever.....
12398	1145	" " " Hinge Pin.....
12329	1145	" " " Spring.....
19193	1146	" " " (intermediate).....
19231	1146	" " " " Hinge Block.....
2269	1146	Tension Releasing Lever (intermediate) Hinge Pin.....
19194	1146	Tension Releasing Lever (intermediate) Spring.....
916c	1146	Tension Screw Stud.....
44209	—	" " " 916c with 1560c.....
1547b	1146	" " " Nut.....
2923	1146	" Spring.....
12149	2584	" Thread Guard.....
19195	1146	Tension complete (upper) with Tension Release, Nos. 2269, 19191, 19193, 19194, 44209, two each 1547b, 2923, 19192 and four 2921.....
19159	2584	Thread Guide Body.....
19161	2584	" " Cap.....
19160	2584	" " Roller.....
905b	2584	" " Screw.....
19162	—	Thread Guide complete (roller) Nos. 905b and 19159 to 19161.....
9543	2584	Thread Retainer Disc.....
9544	2584	" " " Cover.....
185c	2591	" " " " Screw.....
9545	2584	" " " Spring.....
19337	2584	" " Thread Guard.....
24129	2582	" Take-up Crank.....
3094	2582	" " " Wedge.....
690E	2591	" " " " Screw.....
19156	2582	" " Lever.....
775E	2591	" " " Cap Screw.....

NO.	PLATE	NAME
12166	2582	Thread Take-up Lever Hinge Pin.....
12409	2582	“ “ “ Link.....
11204	2582	“ “ “ “ Hinge Pin....
430c	2591	“ “ “ “ “ “ Set Screw.....
19157	—	Thread Take-up Lever complete, Nos. 12166, 12409 and 19156.....
19158	2584	Thread Take-up Spring.....
7336	2584	“ “ “ Regulator.....
448c	783	“ “ “ “ Set Screw
24593	2586	Throat Plate for 24592.....
24595	2586	“ “ “ 24594.....
691F	782	“ “ Screw.....
24079	5877	Drip Pan with four 1 in. wire nails.....

LIST OF PARTS COMPLETE FOR



MACHINE No. 44-84

FOR TWO-ROW STITCHING IN LIGHT AND MEDIUM WEIGHT FABRICS. HAS MECHANISM FOR THROWING THE LEFT HAND NEEDLE OUT OF ACTION. TWO NEEDLES, TWO SHUTTLES. GAUGES FROM $\frac{3}{32}$ IN. TO 1 IN. FITTED WITH REGULATING SCREWS IN THE ARM BRACKET TO REGULATE THE ACTION OF THE BELL CRANK THAT ACTUATES THE NEEDLE BAR LOCKING PIN. KNEE LIFTER.

NO.	PLATE	NAME
*24916	—	Arm with 11104.....
8582	1220	“ Dowel Pin.....
12453	1220	“ Oil Tube for intermediate bearing...
12454	1220	“ “ “ with 29599, for oiling 12409
11119	1220	“ “ “ “ “ “ “ 19156
24131	2582	“ “ “ “ “ “ “ 24035
29599	2582	“ “ “ Packing (felt).....
748E	782	“ Screw (back).....

NO.	PLATE	NAME
868E	1221	Arm Screw (front).....
16511	2578	" Shaft.....
*11104	—	" " Bushing (front).....
12357	2583	" " Flanged Bushing (back).....
448c	783	" " " " " " S e t Screw.....
144d	782	Arm Shaft Screw.....
12480	2583	" Side Cap.....
219d	2591	" " " Screw.....
12193	2579	" " Cover.....
286d	783	" " " Thumb Screw.....
2415	—	" Spool Bracket.....
15063	2579	" " " 2415 with two 12403.....
145d	782	" " " Screw.....
12403	1220	" " " Spool Pin and Thread Eyelet.....
11241	2583	Arm Spool Bracket Spool Pin Washer (cloth).....
24296	2579	Balance Wheel (power) light rim, 2 $\frac{3}{16}$ in. pulley, with two 448c.....
24297	2579	Balance Wheel Oil Cover.....
210d	2591	" " " " Screw.....
448c	783	" " " Set Screw.....
*24917	—	Bed.....
20197	2578	Crank Connecting Rod with 20198 and two 896E.....
*20198	—	Crank Connecting Rod Cap.....
896E	1221	" " " " Screw.....
908c	1221	" " " Hinge Screw.....
1619E	2591	" " " " " Nut
24918	—	Face Plate.....
24919	2579	Face Plate complete, Nos. 185c, 9544, 9545, 19327, 19337, 24918 and two 9543
19327	1220	Face Plate Thread Guard with 12152....
12152	1220	" " " " Rivet.....
286d	783	" " " Thumb Screw.....
19111	1208	Feed Bar.....
313c	783	" " Screw Centre.....
56813	—	" " " " 313c with 1519J....
1519J	783	" " " " Nut.....
24035	2588	" and Feed Lifting Eccentric with 448c
448c	783	" " " " " Set Screw
24036	2588	" " " " " Sleeve....
3033	1145	" Connecting Link.....
375c	782	" " " Hinge Screw.....
1518E	783	" " " " " Nut..

NO.	PLATE	NAME
24592	2586	Feed Dog with 19118, for $\frac{3}{32}$ in. to $\frac{1}{16}$ in. gauge.....
24596	2587	Feed Dog with 19118, for $\frac{1}{16}$ in. to $\frac{1}{32}$ in. gauge.....
24598	2587	Feed Dog with 19118, for $\frac{1}{2}$ in. to $\frac{3}{32}$ in. gauge.....
24735	2588	Feed Dog with 19118, for $\frac{7}{8}$ in. to 1 in. gauge.....
24594	2586	Feed Dog with 19118, for $\frac{3}{16}$ in. to $\frac{1}{4}$ in. gauge, for shirt collars.....
191c	1221	Feed Dog Screw.....
19116	1220	" " Spring.....
19117	1220	" " " Hook for 19120.....
19118	1220	" " " " " 24592, 24594, 24596, 24598 and 24735.....
24037	2580	Feed Forked Connection.....
375c	782	" " " Hinge Screw....
1518E	783	" " " " " Nut
16504	2578	" Lifting Rock Shaft.....
19236	—	Feed Lifting Rock Shaft complete, Nos. 16504, 16556 and 19120.....
16556	1208	Feed Lifting Rock Shaft Crank (back) with 462c.....
2049	1220	Feed Lifting Rock Shaft Crank (back) Pin.....
462c	1221	Feed Lifting Rock Shaft Crank (back) Set Screw.....
19120	1208	Feed Lifting Rock Shaft Crank (front) with 157J, 19117, 19121 and 19122....
157J	782	Feed Lifting Rock Shaft Crank (front) Clamping Screw.....
19121	1208	Feed Lifting Rock Shaft Crank (front) Roller.....
19122	1208	Feed Lifting Rock Shaft Crank (front) Roller Pin.....
43976	2578	Feed Lifting Rock Shaft Crank Connect- ing Rod with 43977 and two 966E....
*43977	—	Feed Lifting Rock Shaft Crank Connect- ing Rod Cap.....
966E	2591	Feed Lifting Rock Shaft Crank Connect- ing Rod Cap Screw.....
375c	782	Feed Lifting Rock Shaft Crank Connect- ing Rod Hinge Screw.....
1518E	783	Feed Lifting Rock Shaft Crank Connect- ing Rod Hinge Screw Nut.....
307c	783	Feed Lifting Rock Shaft Screw Centre.....

NO.	PLATE	NAME
56814	—	Feed Lifting Rock Shaft Screw Centre 307c with 1513J.....
1513J	783	Feed Lifting Rock Shaft Screw Centre Nut
3039	2583	" Regulator.....
1128E	2591	" " Hinge Screw.....
818D	783	" " Thumb Screw.....
16506	2578	" Rock Shaft.....
24376	—	Feed Rock Shaft complete, Nos. 16506 and 29633.....
29633	2583	Feed Rock Shaft Crank with 157J.....
157J	782	" " " " Clamping Screw.
307C	783	" " " Screw Centre.....
56814	—	" " " " " 307c with 1513J.....
1513J	783	Feed Rock Shaft Screw Centre Nut.....
*62589	2580	Needle Bar, for left hand needle, with 4766
*62594	2580	" " " right hand needle, with 620c
62595	2580	Needle Bar complete, for $\frac{3}{8}$ in. to $\frac{9}{16}$ in. gauge, Nos. 665D, 930E, 19452, 19460, 50257E, 62589, 62591, 62593, 62594, 62596 and two 207F.....
62597	—	Needle Bar complete, for $\frac{5}{16}$ in. to $\frac{11}{16}$ in. gauge, Nos. 665D, 930E, 19452, 19460, 50257E, 62589, 62591, 62593, 62594, 62598 and two 207F.....
62590	—	Needle Bar complete, for $\frac{7}{16}$ in. gauge and above, Nos. 665D, 930E, 19452, 19460, 24938, 50257E, 62589, 62591, 62593, 62594 and two 207F.....
62591	2583	Needle Bar Collar.....
207F	2591	" " " Screw.....
24923	2582	" " Connecting Link with 794E..
794E	782	" " " " Adjusting Screw.....
*62592	—	Needle Bar Connecting Stud.....
62593	2583	Needle Bar Connecting Stud complete, Nos. 1904 and 62592.....
1904	2583	Needle Bar Connecting Stud Roller (roller only).....
930E	2591	Needle Bar Connecting Stud Screw (lower)
50257E	2591	" " " " " (upper)
4766	2581	" " Coupling.....
19452	2581	" " " Pin.....
24926	2581	" " " " Lever.....
24927	2581	" " " " " Hub with 207F.....

NO.	PLATE	NAME
207F	2591	Needle Bar Coupling Pin Lever Hub Set Screw.....
1735H	2591	Needle Bar Coupling Pin Lever Lock Nut
19454	2581	" " " " " Shaft....
19457	—	Needle Bar Coupling Pin Lever Shaft complete, Nos. 2273, 19454 and 19456.....
24928	2581	Needle Bar Coupling Pin Lever Shaft Bracket.....
175E	2591	Needle Bar Coupling Pin Lever Shaft Bracket Screw.....
19456	2581	Needle Bar Coupling Pin Lever Shaft Crank.....
2273	2581	Needle Bar Coupling Pin Lever Shaft Crank Pin.....
24929	2581	Needle Bar Coupling Pin Stop.....
219F	2591	" " " " " Screw....
20188	2582	" " Crank with 858c and 1065c..
1065c	2591	" " " Position Screw.....
858c	783	" " " Set Screw.....
931E	2591	" " Screw Bushing.....
24930	2581	" " Stop with 23548.....
24931	2581	" " " Bracket with 191F.....
24932	2581	" " " " Bar.....
435c	2591	" " " " Set Screw..
191F	1221	" " " " Set Screw.....
24933	2581	" " " Collar with 175D.....
175D	2591	" " " " Clamping Screw..
23474	2581	" " " " Washer (rawhide)
23548	2581	" " " Plug (fibre).....
25478	2581	" " " Spring.....
19460	2581	" " Thread Guide.....
665D	2591	" " " " Screw.....
24935	2580	" " Trip Lever.....
6439	—	" " " " Chain, 36 in. to 45 in.....

NOTE: When ordering No. 6439 give length required.

4879	2594	Needle Bar Trip Lever Chain Connecting Link.....
24936	2580	Needle Bar Trip Lever Connecting Rod
12416	1145	" " " " " " "
76D	782	Needle Bar Trip Lever Connecting Rod Joint Hinge Screw.....
1521E	2591	Needle Bar Trip Lever Connecting Rod Lock Nut.....

NO.	PLATE	NAME
9534	2581	Needle Bar Trip Lever Connecting Rod Spring
19256	2581	Needle Bar Trip Lever Connecting Rod Spring Collar with 187F
187F	2591	Needle Bar Trip Lever Connecting Rod Spring Collar Set Screw
6312	2581	Needle Bar Trip Lever Connecting Rod Spring Washer
19462	2580	Needle Bar Trip Lever Pitman
95D	1221	" " " " " Hinge Screw (crank end)
90D	1221	Needle Bar Trip Lever Pitman Hinge Screw (lever end)
145D	782	Needle Bar Trip Lever Stop Screw (left)
1528J	2591	" " " " " " " " Lock Nut
145D	782	Needle Bar Trip Lever Stop Screw (right)
1528J	2591	" " " " " " " " Lock Nut
24937	2592	Needle Bar Trip Lever Stop Screw Bracket
161D	2591	" " " " " " " " Screw
4881	2594	Needle Bar Trip Lever Treadle
4882	2592	" " " " " Shaft
4883	2590	" " " " " Spring
4884	2594	" " " " " Stand
4885	2594	Needle Bar Trip Lever Treadle complete, Nos. 4879, 4881 to 4884 and two wood screws 1 in. No. 16
*62596	2585	Needle Clamp, for left hand needle, with 994F, for $\frac{3}{32}$ in. to $\frac{9}{64}$ in. gauge, for 62595
62598	2585	Needle Clamp, for left hand needle, with 620C and 994F, for $\frac{5}{32}$ in. to $\frac{11}{64}$ in. gauge, for 62597
24938	2585	Needle Clamp, for left hand needle, with 250F and 620C, for $\frac{7}{32}$ in. gauge and above, for 62590
250F	2591	Needle Clamp Set Screw for 24938
994F	2591	" " " " " 62596 and 62598
620C	2591	Needle Set Screw, for right hand needle
19386	2580	Oscillating Rock Shaft
19387	—	Oscillating Rock Shaft complete, Nos. 4784, 12388 and 19386
12388	2582	Oscillating Rock Shaft Hinge Pin
878J	783	" " " " " Oil Hole Stop Screw

NO.	PLATE	NAME
12459	1220	Oscillating Rock Shaft Hinge Pin Oil Hole Stop Screw Washer (leather)
448c	783	Oscillating Rock Shaft Hinge Pin Set Screw
4784	2584	Oscillating Rock Shaft Oil Pad
19127	2578	" Shaft
19496	—	" " Crank
19388	1208	Oscillating Shaft Crank complete, Nos. 457c, 1518E, 19390 and 19496
2049	1220	Oscillating Shaft Crank Pin
457c	783	" " " Set Screw
19389	1208	" " " Slide Block
229D	782	" " " " " Cap Screw
12424	1208	Oscillating Shaft Crank Slide Block Cap Screw Washer
969c	1208	Oscillating Shaft Crank Slide Block Screw Stud
1518E	783	Oscillating Shaft Crank Slide Block Screw Stud Nut
19390	1208	Oscillating Shaft Crank Slide Block complete, Nos. 229D, 969c, 12424 and 19389
12391	2580	Presser Bar (hollow)
12326	1145	" " Guide Bracket with 453c
453c	783	" " " Set Screw
2062	1145	" " Lifter
689c	782	" " " Screw
1520E	783	" " " Nut
12327	1145	" " Lifting and Releasing Lever Bracket
11167	2582	Presser Bar Spring
11170	1220	" " " Washer
24600	2586	" Foot, for plain work
120225	2588	" " braiding
62687	2589	" " (tube) for taping
62688	2589	" " for shirt collars
62690	2589	" " slotted in front of needle holes, for tape
26276	2586	Presser Foot Hinge Pin
62691	—	" " Plate
62692	—	" " Shank
62693	2586	Presser Foot (hinged) complete, Nos. 26276, 62691 and 62692
26276	2586	Presser Foot Hinge Pin
62694	—	" " Plate
62692	—	" " Shank

NO.	PLATE	NAME
62695	2589	Presser Foot (hinged) slotted in front of needle holes, for tape, complete, Nos. 26276, 62692 and 62694.
190D	782	Presser Foot Screw.
688J	783	Pressure Regulating Thumb Screw.
19131	1216	Shuttle (inside) Bobbin Case.
62606	—	“ “ “ “ Case.
19310	1217	“ “ “ “ Latch and Position Finger.
2521	1216	Shuttle (inside) Bobbin Case Latch and Position Finger Spring.
592E	1216	Shuttle (inside) Bobbin Case Latch and Position Finger Stop Screw.
19312	1217	Shuttle (inside) Bobbin Case complete, Nos. 591F, 592E, 2521, 19149, 19310 and 62606.
19136	1216	Shuttle (inside) Body.
591F	1216	“ “ Tension Regulating Screw.
19149	1216	“ “ “ Spring.
19324	1217	Shuttle (inside) 1 $\frac{1}{8}$ in. diam., Nos. 19131, 19136 and 19312.
19131	1216	Shuttle (outside) Bobbin Case.
62608	—	“ “ “ “ Case.
19311	1217	“ “ “ “ Latch and Position Finger.
2521	1216	Shuttle (outside) Bobbin Case Latch and Position Finger Spring.
592E	1216	Shuttle (outside) Bobbin Case Latch and Position Finger Stop Screw.
19313	1217	Shuttle (outside) Bobbin Case complete, Nos. 591F, 592E, 2521, 19172, 19311 and 62608.
19137	1216	Shuttle (outside) Body for 19325.
19171	1217	“ “ “ “ 19326.
591F	1216	“ “ Tension Regulating Screw.
19172	1216	“ “ “ Spring.
19326	1217	Shuttle (outside) 1 $\frac{1}{8}$ in. diam., for $\frac{3}{8}$ in. to $\frac{1}{4}$ in. gauge, Nos. 19131, 19171 and 19313.
19325	1217	Shuttle (outside) 1 $\frac{1}{8}$ in. diam., for $\frac{3}{8}$ in. gauge and above, Nos. 19131, 19137 and 19313.
19139	1208	Shuttle Driver with two 453c.
2049	1220	“ “ Pin.
453c	783	“ “ Set Screw.
19315	—	“ Race Body with 19316, for 19323.
19379	—	“ “ “ for 24013.

NO.	PLATE	NAME
19316	1213	Shuttle Race Loop Separator for 19315.
19309	1213	“ “ Needle Guard for 19323 and 24013.
1053D	2591	Shuttle Race Needle Guard Screw.
19317	1213	“ “ Ring (inside) for 19323 and 24013.
19318	1213	Shuttle Race Ring (outside) for 19323 and 24013.
2532	1220	Shuttle Race Ring Position Pin.
2533	2585	“ “ “ Spring.
907D	1221	“ “ “ “ Screw.
19323	1213	Shuttle Race complete, for $\frac{3}{8}$ in. to $\frac{5}{32}$ in. gauge, Nos. 19309, 19315, 19317, 19318, two each 907D, 1053D, 2533 and four 2532.
24013	2585	Shuttle Race complete, for $\frac{1}{4}$ in. gauge and above, Nos. 19309, 19317, 19318, 19379, two each 907D, 1053D, 2533 and four 2532.
145D	782	Shuttle Race Screw.
19145	2590	“ “ Slide (inside).
19146	2590	“ “ “ (outside) for $\frac{1}{16}$ in. gauge and below.
19281	2590	Shuttle Race Slide (outside) for $\frac{3}{8}$ in. to $\frac{15}{16}$ in. gauge.
19385	2590	Shuttle Race Slide (outside) for $\frac{3}{8}$ in. and above.
19147	1220	Shuttle Race Slide Friction Spring.
651E	1221	“ “ “ “ “ Screw.
19148	2590	“ “ “ Guide (back) with 651E and 19147.
19185	2590	Shuttle Race Slide Guide (front) with 651E and 19147.
691F	782	Shuttle Race Slide Guide Screw.
2921	1146	Tension Disc.
19191	1146	“ Plate, for upper tension, with 19231.
134D	1221	Tension Plate Screw.
1560c	1146	“ Regulating Thumb Nut.
19192	1146	“ Releaser.
12397	1145	“ Releasing Lever.
12398	1145	“ “ “ Hinge Pin.
12329	1145	“ “ “ Spring.
19193	1146	“ “ “ (intermediate).
19231	1146	“ “ “ “ Hinge Block.

NO.	PLATE	NAME
2269	1146	Tension Releasing Lever (intermediate) Hinge Pin.....
19194	1146	Tension Releasing Lever (intermediate) Spring.....
916c	1146	Tension Screw Stud.....
44209	—	" " " 916c with 1560c.....
1547D	1146	" " " Nut.....
2923	1146	" Spring.....
12149	2584	" Thread Guard.....
19195	1146	Tension complete (upper) with Tension Release, Nos. 2269, 19191, 19193, 19194, 44209, two each 1547D, 2923, 19192 and four 2921.....
19159	2584	Thread Guide Body.....
19161	2584	" " Cap.....
19160	2584	" " Roller.....
905D	2584	" " Screw.....
19162	—	Thread Guide complete (roller) Nos. 905D and 19159 to 19161.....
9543	2584	Thread Retainer Disc.....
9544	2584	" " " Cover.....
185c	2591	" " " " Screw.....
9545	2584	" " " Spring.....
19337	2584	" " Thread Guard.....
12404	2588	* Take-up Crank.....
3094	2582	" " " Wedge.....
690E	2591	" " " " Screw.....
19156	2582	" " Lever.....
775E	2591	" " Cap Screw.....
12166	2582	" " Hinge Pin.....
12409	2582	" " Link.....
11204	2582	" " " " Hinge Pin.....
430c	2591	" " " " " " " " Set Screw.....
19157	—	Thread Take-up Lever complete, Nos. 12166, 12409 and 19156.....
19158	2584	Thread Take-up Spring.....
7336	2584	" " " Regulator.....
448c	783	" " " " Set Screw.....
24593	2586	Throat Plate for 24592.....
24597	2587	" " " 24596.....
24599	2587	" " " 24598.....
24736	2588	" " " 24735.....
24595	2586	" " " 24594.....
62689	2589	" " " 19215, for 24594.....
691F	782	" " Screw.....
24079	5877	Drip Pan with four 1 in. wire nails.....

ATTACHMENTS AND ACCESSORIES

NO.	PLATE	NAME
687E	2591	Machine Hinge Bolt with 1524E.....
1524E	2591	" " " Nut.....
6055	2592	" " " " Washer.....
12361	2592	" " Connection.....
44139	2592	" " Plate.....
44140	—	Machine Hinge complete, Nos. 12361, 44139 and wood screw 1¼ in. No. 14..
44180	—	Machine Hinge complete, Nos. 687E, 6055, 12361 and 44139.....
12405	2592	Machine Rest (felt).....
28084	2591	" " Pin.....
41400	2580	" " " (wood) 3½ in. long.....
36565	1161	Oiler (copper plated) with 36566.....
36566	1161	" Spout, 9 in. long, with 120117.....
120117	2580	" " Washer (leather).....
26026	1161	Screw Driver (machine).....
26485	1161	" " (shuttle tension).....
35143	1161	Tweezers, 4 in.....
4822	2578	Wrench for 1521, 1528, 1547 and 1549...
8908	1161	" " 1519 and 1520.....
8909	2578	" " 1513 and 1518.....
19221	1161	" " 1619.....
22003	2578	" " 1735.....

GUIDE

FOR SHIRT COLLARS, FOR 44-84 MACHINE

NO.	PLATE	NAME
19215	2589	Guide.....
207D	2589	" Screw.....
7071	2589	" " Washer.....

TAPE GUIDE

FOR 44-84 MACHINE

NO.	PLATE	NAME
52838	2593	Tape Guide with 759D.....
62684	2593	" " Arm with two 52840.....
190D	2593	" " " Screw.....
62685	2593	" " " Bracket with 1147J.....
1147J	2593	" " " Set Screw.....
52839	2593	" " Block with 460C.....

NO.	PLATE	NAME
460c	2593	Tape Guide Block Set Screw
52840	2593	" " Pin
759D	2593	" " Thumb Screw
62686	—	Tape Guide complete, Nos. 190D, 52838, 52839, 62684 and 62685

TAPE HOLDER

FOR 44-84 MACHINE

NO.	PLATE	NAME
41832	2594	Tape Holder Rod
138B	2593	" " " Set Screw
60925	2594	" " Spindle
446F	783	" " " Set Screw
41834	2594	" " " Bracket with 446F and 448F
448F	783	Tape Holder Spindle Bracket Set Screw
41875	2593	" " " Cone (inside) with 249D
249D	2593	Tape Holder Spindle Cone (inside) Set Screw
13211	2593	Tape Holder Spindle Cone (inside) Spring
41876	2593	" " " " (outside) with 793D
793D	2593	Tape Holder Spindle Cone (outside) Set Screw
27618	2594	Tape Holder Stand with 138B
60926	2594	Tape Holder complete, Nos. 13211, 27618, 41832, 41834, 41875, 41876 and 60925

BOBBIN WINDER

(SWINGING AUTOMATIC, RIGHT HAND)
FOR 19131

NO.	PLATE	NAME
27552	1162	Base
15072	1220	Bobbin Position Pin
27302	1162	Frame
50356D	2591	" Hinge Screw
1620J	2591	" " " Nut
27303	1220	" Spring
27553	1162	Pulley
27538	1162	Spindle with 15072
27306	1162	Spool Pin
27307	1162	" Stand

NO.	PLATE	NAME
27308	1162	Spool Stand complete, Nos. 418E, 1562J, 2106, 10141, 11241, 27306, 27307 and two each 2455 and wood screws 1 in. No. 10
11241	2583	Spool Washer (cloth)
27587	1162	Stop Latch
35D	1221	" " Hinge Screw
2455	1220	Tension Disc
1562J	2591	" Regulating Thumb Nut
418E	1221	" Screw Stud
10141	1220	" Spring
2106	1220	" Thread Guide
27651	1162	Bobbin Winder, Nos. 35D, 1620J, 27302, 27303, 27538, 27552, 27553, 27587, 50356D and two wood screws 1 in. No. 7
27588	—	Bobbin Winder (swinging automatic, right hand) complete, Nos. 27308 and 27651

BOBBIN WINDER

(SWINGING AUTOMATIC, RIGHT HAND)
FOR 19131
FOR POWER TABLE

NO.	PLATE	NAME
*225451	—	Bobbin Holder
225463	3469	" Winder and Tension Bracket Base
225453	3470	Frame with 202277 and 225438
225454	3471	" Hinge Pin
202277	3471	" Oil Packing (wick)
225438	3471	" " Well Cap
225455	3471	" Spring
225456	3471	" " Plunger
202473	3470	Pulley with 200380c
200380c	3471	" Set Screw
*225443	—	Spindle
225452	3470	" 225443 with 225451
225444	3471	Stop Latch
200056E	3471	" " Screw
225458	3471	" " Thumb Lever
225459	3471	" " " " Hinge Stud
225460	3471	" " " " Joint Stud
202478	3471	" " Trip Lever
200299H	3471	" " " " Hinge Screw
225461	3471	Tension Bracket with 201499b
200082D	3471	" " Screw
202104	3471	" " " Washer

NO.	PLATE	NAME
2102	3471	Tension Disc.....
202407	3471	" Spring.....
201499b	3471	" Stud.....
201572b	3471	" " Thumb Nut.....
225462	—	Tension Bracket complete, Nos. 201572b, 202407, 225461 and two 2102.....
225436	3469	Bobbin Winder (swinging automatic, right hand) complete, Nos. 200056e, 200082d, 200299h, 202104, 202473, 202478, 225444, 225452 to 225456, 225458 to 225460, 225462, 225463 and two wood screws 3/4 in. No. 13 R. H. B.

KNEE LIFTER PARTS

NO.	PLATE	NAME
5596	2592	Bell Crank.....
56848	—	" " 5596 with 5599 and 5601.....
5599	2592	" " Bracket.....
178e	782	" " " Screw.....
5601	1220	" " Hinge Pin.....
5735	1220	" " Spring.....
5598	2579	Bell Crank complete, Nos. 5735 and 56848
24939	2590	Lifting Lever with 448c.....
24940	2590	" " Connecting Rod.....
12416	1145	" " " " Joint.....
76d	782	" " " " " Hinge Screw.....
1521e	2591	Lifting Lever Connecting Rod Lock Nut
802d	782	" " Hinge Screw.....
12241	1145	" " Link.....
766d	782	" " " Hinge Screw.....
12240	1145	" " Pin.....
448c	783	" " " Set Screw.....
2763	5877	Rock Shaft.....
12242	5877	" " Hanger with two wood screws 1 in. No. 10.....
2765	5877	Rock Shaft Knee Arm.....
2766	5877	" " " " Hub with 356c....
356c	783	" " " " " Set Screw....
2768	—	Rock Shaft Knee Arm complete, Nos. 2765 to 2767.....
2767	5877	Rock Shaft Knee Plate with 356c.....
356c	783	" " " " Set Screw.....
6337	5877	" " Lifting Bracket with two 356c
2778	5877	" " " " Hook.....
356c	783	" " " " " Set Screw
356c	783	" " " " " Set Screw....

NO.	PLATE	NAME
2770	5877	Rock Shaft Stop Dog with 356c.....
356c	783	" " " " Set Screw.....
2777	5877	Rock Shaft complete, Nos. 2763, 2768, 2770, 2778, 6337 and two 12242.....
24941	—	Knee Lifter complete, Nos. 76d, 766d, 802d, 1521e, 2777, 5598, 12240, 12241, 12416, 24939, 24940 and two 178e.....

THREAD UNWINDER

FOR THREE LARGE SPOOLS OR THREE
LARGE CONES OF THREAD

NO.	PLATE	NAME
27623	5571	Spool Pin.....
155c	2591	" " Set Screw.....
41434	5571	" Rest.....
60697	—	" " 41434 with 1149c and three 155c.....
41435	—	Spool Rest 60697 with three 27623.....
1149c	2591	" " Set Screw.....
27940	5571	" Stand with 453c.....
41514	5571	" Weight, 4 in. diam., with 41515....
41515	2592	" " Centre Pin.....
27739	5571	Thread Cone (wood).....
41632	5571	" Guard with 208e and three 41569
41569	2592	" " Eyelet.....
41637	5571	" " Rod (lower).....
41638	5571	" " " (upper).....
41639	5571	" " " Coupling with two 456c
456c	2591	" " " " Set Screw....
41640	—	Thread Guard Rod complete, 30 in. long, Nos. 41637 to 41639.....
453c	783	Thread Guard Rod Set Screw.....
208e	782	" " Screw.....
41438	5571	Thread Unwinder complete, Nos. 27940, 41435, 41632, 41640 and three each 27739, 41514 and wood screws 1 in. No. 12.....

**NUMERICAL LIST OF PARTS
FOR
MACHINES
Nos. 44-40 and 44-84**

NO.	PLATE	NAME
191f	1221	Needle Bar Stop Bracket Set Screw for 24931
207b	2589	Guide Screw for 19215
207f	2591	Needle Bar Collar Screw for 62590, 62595 and 62597
207f	2591	Needle Bar Coupling Pin Lever Hub Set Screw for 24927
208e	782	Thread Unwinder Thread Guard Screw for 41632
210b	2591	Balance Wheel Oil Cover Screw
219b	2591	Arm Side Cap Screw
219f	2591	Needle Bar Coupling Pin Stop Screw
229b	782	Oscillating Shaft Crank Slide Block Cap Screw for 49390
249b	2593	Tape Holder Spindle Cone (inside) Set Screw for 41875
250f	2591	Needle Clamp Set Screw for 24938
286b	783	Arm Side Cover Thumb Screw
286b	783	Face Plate Thumb Screw
307c	783	Feed Lifting Rock Shaft Screw Centre for 56811
307c	783	Feed Rock Shaft Screw Centre for 56814
313c	783	" Bar Screw Centre for 56813
316f	1221	Roller Arm Bracket Screw Centre for 24602 and 24604
356c	783	Rock Shaft Knee Arm Hub Set Screw for 2766
356c	783	Rock Shaft Knee Plate Set Screw for 2767
356c	783	" " Lifting Bracket Hook Set Screw for 6337
356c	783	Rock Shaft Lifting Bracket Set Screw for 6337
356c	783	Rock Shaft Stop Dog Set Screw for 2770
375c	782	Feed Connecting Link Hinge Screw
375c	782	" Forked Connection Hinge Screw
375c	782	" Lifting Rock Shaft Crank Connecting Rod Hinge Screw
418e	1221	Bobbin Winder Tension Screw Stud for 27308
430c	2591	Thread Take-up Lever Link Hinge Pin Set Screw
435c	2591	Needle Bar Stop Bracket Bar Set Screw
440f	1221	Roller Arm Adjusting Screw for 24602 and 24604
446c	783	Feed Cam and Feed Lifting Eccentric Set Screw for 42197
446f	783	Tape Holder Spindle Set Screw for 41834

NUMERICAL LIST OF PARTS

NO.	PLATE	NAME
35D	1221	Bobbin Winder Stop Latch Hinge Screw for 27651.....
76D	782	Lifting Lever Connecting Rod Joint Hinge Screw for 24944.....
76D	782	Needle Bar Trip Lever Connecting Rod Joint Hinge Screw.....
90D	1221	Needle Bar Trip Lever Pitman Hinge Screw (lever end).....
95D	1221	Needle Bar Trip Lever Pitman Hinge Screw (crank end).....
E34D	1221	Tension Plate Screw.....
E38B	2593	Tape Holder Rod Set Screw for 27618.....
E44D	782	Arm Shaft Screw.....
E45D	782	" Spool Bracket Screw.....
E45D	782	Needle Bar Trip Lever Stop Screw (left)
E45D	782	" " " " " " (right)
E45D	782	Shuttle Race Screw.....
E55C	2591	Thread Unwinder Spool Pin Set Screw for 60697.....
E57J	782	Feed Lifting Rock Shaft Crank (front) Clamping Screw for 19120.....
E57J	782	Feed Rock Shaft Crank Clamping Screw for 29633.....
E61D	2591	Needle Bar Trip Lever Stop Screw Bracket Screw.....
E71F	1221	Roller Needle Guard (round) Set Screw for 24602 and 24604.....
E75E	2591	Needle Bar Coupling Pin Lever Shaft Bracket Screw.....
E75D	2591	Needle Bar Stop Collar Clamping Screw for 24933.....
E76D	1221	Roller Arm Lock Spring Screw for 24602 and 24604.....
E78E	782	Bell Crank Bracket Screw for 24944.....
E85C	2591	Thread Retainer Disc Cover Screw for 24919.....
E87F	2591	Needle Bar Trip Lever Connecting Rod Spring Collar Set Screw for 19256.....
E90D	782	Presser Foot Screw.....
E90D	782	Roller Presser Screw.....
E90D	2593	Tape Guide Arm Screw for 62686.....
E91C	1221	Feed Dog Screw.....

NO.	PLATE	NAME
E48C	783	Arm Shaft Flanged Bushing (back) Set Screw.....
E48C	783	Balance Wheel Set Screw for 24296.....
E48C	783	Feed and Feed Lifting Eccentric Set Screw for 24035.....
E48C	783	Lifting Lever Pin Set Screw for 24939.....
E48C	783	Oscillating Rock Shaft Hinge Pin Set Screw.....
E48E	783	Tape Holder Spindle Bracket Set Screw for 41834.....
E48C	783	Thread Take-up Spring Regulator Set Screw.....
E53C	783	Presser Bar Guide Bracket Set Screw for 12326.....
E53C	783	Shuttle Driver Set Screw for 19139.....
E53C	783	Thread Unwinder Thread Guard Rod Set Screw for 27940.....
E56C	2591	Thread Unwinder Thread Guard Rod Coupling Set Screw for 41639.....
E57C	783	Oscillating Shaft Crank Set Screw for 19388.....
E60C	2593	Tape Guide Block Set Screw for 52839.....
E62C	1221	Feed Lifting Rock Shaft Crank (back) Set Screw for 16556.....
E591F	1216	Shuttle (inside) Tension Regulating Screw for 19312.....
E591F	1216	Shuttle (outside) Tension Regulating Screw for 19313.....
E592E	1216	Shuttle (inside) Bobbin Case Latch and Position Finger Stop Screw for 19312.....
E592E	1216	Shuttle (outside) Bobbin Case Latch and Position Finger Stop Screw for 19313.....
E620C	2591	Needle Set Screw, for right hand needle, for 24938 and 62598.....
E634D	1221	Roller Screw for 1875.....
E651E	1221	Shuttle Race Slide Friction Spring Screw for 19118 and 19185.....
E652D	2591	Roller Screw for 1903.....
E665D	2591	Needle Bar Thread Guide Screw for 62590, 62595 and 62597.....
E687E	2591	Machine Hinge Bolt with 1521E, for 44180.....
E688J	783	Pressure Regulating Thumb Screw.....
E689C	782	Presser Bar Lifter Screw.....
E690E	2591	Thread Take-up Crank Wedge Screw.....
E691F	782	Shuttle Race Slide Guide Screw.....
E691F	782	Throat Plate Screw.....
E748E	782	Arm Screw (back).....

NO.	PLATE	NAME
759d	2593	Tape Guide Thumb Screw for 52838
766d	782	Lifting Lever Link Hinge Screw for 24944
775e	2591	Thread Take-up Lever Cap Screw
793d	2593	Tape Holder Spindle Cone (outside) Set Screw for 41876
794e	782	Needle Bar Connecting Link Adjusting Screw for 24923
802d	782	Lifting Lever Hinge Screw for 24944
818d	783	Feed Regulator Thumb Screw
858c	783	Needle Bar Crank Set Screw for 20188
868e	1221	Arm Screw (front)
878j	783	Oscillating Rock Shaft Hinge Pin Oil Hole Stop Screw
896e	1221	Crank Connecting Rod Cap Screw for 20197
905d	2584	Thread Guide Screw for 19162
907d	1221	Shuttle Race Ring Spring Screw for 19323 and 24013
908c	1221	Crank Connecting Rod Hinge Screw
916c	1146	Tension Screw Stud for 44209
930e	2591	Needle Bar Connecting Stud Screw (lower) for 62590, 62595 and 62597
931e	2591	Needle Bar Screw Bushing
966e	2591	Feed Lifting Rock Shaft Crank Connecting Rod Cap Screw for 43976
969c	1208	Oscillating Shaft Crank Slide Block Screw Stud for 19390
994f	2591	Needle Clamp Set Screw for 62596 and 62598
1053d	2591	Shuttle Race Needle Guard Screw for 19323 and 24013
1065c	2591	Needle Bar Crank Position Screw for 20188
1128e	2591	Feed Regulator Hinge Screw
1147j	2593	Tape Guide Arm Bracket Set Screw for 62685
1149c	2591	Thread Unwinder Spool Rest Set Screw for 60697
1513j	783	Feed Lifting Rock Shaft Screw Centre Nut for 56814
1513j	783	Feed Rock Shaft Screw Centre Nut for 56814
1518e	783	Feed Forked Connection Hinge Screw Nut
1518e	783	" Connecting Link Hinge Screw Nut

NO.	PLATE	NAME
1518e	783	Feed Lifting Rock Shaft Crank Connecting Rod Hinge Screw Nut
1518e	783	Oscillating Shaft Crank Slide Block Screw Stud Nut for 19388
1519j	783	Feed Bar Screw Centre Nut for 56813
1520e	783	Pressor Bar Lifter Screw Nut
1521e	2591	Lifting Lever Connecting Rod Lock Nut for 24944
1521e	2591	Needle Bar Trip Lever Connecting Rod Lock Nut
1521e	2591	Machine Hinge Bolt Nut for 687
1528j	2591	Needle Bar Trip Lever Stop Screw (left) Lock Nut
1528j	2591	Needle Bar Trip Lever Stop Screw (right) Lock Nut
1528j	2591	Roller Screw Nut for 1875 and 1903
1547j	1146	" Arm Adjusting Screw Nut for 24602 and 24604
1547j	1146	Roller Arm Bracket Screw Centre Nut for 24602 and 24604
1547d	1146	Tension Screw Stud Nut for 19195
1549j	2591	Roller Arm Lock Spring Screw Nut for 24602 and 24604
1560c	1146	Tension Regulating Thumb Nut for 44209
1562j	2591	Bobbin Winder Tension Regulating Thumb Nut for 27308
1619e	2591	Crank Connecting Rod Hinge Screw Nut
1620j	2591	Bobbin Winder Frame Hinge Screw Nut for 27651
1735h	2591	Needle Bar Coupling Pin Lever Lock Nut
1875	2584	Roller, 1½ in. diam., with 634d and 1528j, for 24604
1903	2584	Roller, 1¼ in. diam., with 652d and 1528j, for 24602
1904	2583	Needle Bar Connecting Stud Roller (roller only) for 62593
2049	1220	Feed Lifting Rock Shaft Crank (back) Pin
2049	1220	Oscillating Shaft Crank Pin
2049	1220	Shuttle Driver Pin
2062	1145	Pressor Bar Lifter
2102	3471	Bobbin Winder Tension Disc for 225462
2106	1220	" " " Thread Guide for 27308
2269	1146	Tension Releasing Lever (intermediate) Hinge Pin for 19195
2273	2581	Needle Bar Coupling Pin Lever Shaft Crank Pin for 19457

NO.	PLATE	NAME
2415	—	Arm Spool Bracket for 15063
2455	1220	Bobbin Winder Tension Disc for 27308
2521	1216	Shuttle (inside) Bobbin Case Latch and Position Finger Spring for 19312
2521	1216	Shuttle (outside) Bobbin Case Latch and Position Finger Spring for 19313
2532	1220	Shuttle Race Ring Position Pin for 19323 and 24013
2533	2585	Shuttle Race Ring Spring for 19323 and 24013
2763	5877	Rock Shaft for 2777
		Nos. 2765 to 2767 FOR 2768
2765	5877	Rock Shaft Knee Arm
2766	5877	" " " " Hub with 356c
2767	5877	" " " " Plate with 356c
2768	—	Rock Shaft Knee Arm complete for 2777, Nos. 2765 to 2767
2770	5877	Rock Shaft Stop Dog with 356c, for 2777
2777	5877	Rock Shaft complete for 24941, Nos. 2763, 2768, 2770, 2778, 6337 and two 12242
2778	5877	Rock Shaft Lifting Bracket Hook for 2777
2921	1146	Tension Disc for 19195
2923	1146	" Spring for 19195
3033	1145	Feed Connecting Link
3039	2583	" Regulator
3094	2582	Thread Take-up Crank Wedge
4766	2581	Needle Bar Coupling for 62589
4784	2584	Oscillating Rock Shaft Oil Pad for 19387
4822	2578	Wrench for 1521, 1528, 1547 and 1549 (Attachments and Accessories)
4879	2594	Needle Bar Trip Lever Chain Connecting Link for 4885
		Nos. 4881 to 4884 FOR 4885
4881	2594	Needle Bar Trip Lever Treadle
4882	2592	" " " " Shaft
4883	2590	" " " " Spring
4884	2594	" " " " Stand
4885	2594	Needle Bar Trip Lever Treadle complete, Nos. 4879, 4881 to 4884 and two wood screws 1 in. No. 16
5596	2592	Bell Crank for 56848
5598	2579	Bell Crank complete for 24941, Nos. 5735 and 56848
5599	2592	Bell Crank Bracket for 56848
5601	1220	" " Hinge Pin for 56848
5735	1220	" " Spring for 5598

NO.	PLATE	NAME
6055	2592	Machine Hinge Bolt Nut Washer for 44180
6312	2581	Needle Bar Trip Lever Connecting Rod Spring Washer
6337	5877	Rock Shaft Lifting Bracket with two 356c, for 2777
6439	—	Needle Bar Trip Lever Chain, 36 in. to 45 in.
7071	2589	Guide Screw Washer for 19215
7336	2584	Thread Take-up Spring Regulator
7556	2584	Roller Arm Lock Spring for 24602 and 24604
8582	1220	Arm Dowel Pin
8908	1161	Wrench for 1519 and 1520 (Attachments and Accessories)
8909	2578	Wrench for 1513 and 1518 (Attachments and Accessories)
9534	2581	Needle Bar Trip Lever Connecting Rod Spring
		Nos. 9543 to 9545 FOR 24919
9543	2584	Thread Retainer Disc
9544	2584	" " " Cover
9545	2584	" " " Spring
10111	1220	Bobbin Winder Tension Spring for 27308
*11104	—	Arm Shaft Bushing (front) for 24916
11119	1220	" Oil Tube with 29599, for oiling 19156
11167	2582	Presser Bar Spring
11170	1220	" " " Washer
11204	2582	Thread Take-up Lever Link Hinge Pin
11241	2583	Arm Spool Bracket Spool Pin Washer (cloth)
11241	2583	Bobbin Winder Spool Washer (cloth) for 27308
12123	2580	Feed Forked Connection for 44-40 Machine
12149	2584	Tension Thread Guard
12152	1220	Face Plate Thread Guard Rivet for 19327
12166	2582	Thread Take-up Lever Hinge Pin for 19157
12193	2579	Arm Side Cover
12197	2583	Feed Cam and Feed Lifting Eccentric with 446c, for 44-40 Machine
12240	1145	Lifting Lever Pin for 24941
12241	1145	" " Link for 24941
12242	5877	Rock Shaft Hanger with two wood screws 1 in. No. 10, for 2777
12326	1145	Presser Bar Guide Bracket with 453c
12327	1145	" " Lifting and Releasing Lever Bracket

NO.	PLATE	NAME
12329	1145	Tension Releasing Lever Spring
12357	2583	Arm Shaft Flanged Bushing (back)
12361	2592	Machine Hinge Connection for 4140 and 44180
12388	2582	Oscillating Rock Shaft Hinge Pin for 19387
12391	2580	Presser Bar (hollow)
12397	1145	Tension Releasing Lever
12398	1145	" " " Hinge Pin
12403	1220	Arm Spool Bracket Spool Pin and Thread Eyelet for 15063
12404	2588	Thread Take-up Crank for 44-84 Machine
12405	2592	Machine Rest, felt (Attachments and Accessories)
12409	2582	Thread Take-up Lever Link for 19157
12416	1145	Lifting Lever Connecting Rod Joint for 24941
12416	1145	Needle Bar Trip Lever Connecting Rod Joint
12424	1208	Oscillating Shaft Crank Slide Block Cap Screw Washer for 19390
12453	1220	Arm Oil Tube for intermediate bearing
12454	1220	" " " with 29599, for oiling 12409
12459	1220	Oscillating Rock Shaft Hinge Pin Oil Hole Stop Screw Washer (leather)
12480	2583	Arm Side Cap
13211	2593	Tape Holder Spindle Cone (inside) Spring for 60926
15063	2579	Arm Spool Bracket 2415 with two 12403
15072	1220	Bobbin Winder Bobbin Position Pin for 27538
16504	2578	Feed Lifting Rock Shaft for 19236
16506	2578	" Rock Shaft for 24376
16511	2578	Arm Shaft
16556	1208	Feed Lifting Rock Shaft Crank (back) with 462c, for 19236
19111	1208	Feed Bar
19116	1220	" Dog Spring
19117	1220	" " " Hook for 19120
19118	1220	" " " " " 24592, 24594, 24596, 24598 and 24735
19120	1208	Feed Lifting Rock Shaft Crank (front) with 157a, 19117, 19121 and 19122, for 19236
19121	1208	Feed Lifting Rock Shaft Crank (front) Roller for 19120
19122	1208	Feed Lifting Rock Shaft Crank (front) Roller Pin for 19120

NO.	PLATE	NAME
19127	2578	Oscillating Shaft
19131	1216	Shuttle (inside) Bobbin for 19324
19131	1216	" (outside) Bobbin for 19325 and 19326
19136	1216	Shuttle (inside) Body for 19324
19137	1216	" (outside) Body for 19325
19139	1208	" Driver with two 453c
19145	2590	" Race Slide (inside)
19146	2590	" " " (outside) for 44-40 Machine and for $\frac{7}{16}$ in. gauge and below for 44-84 Machine
19147	1220	Shuttle Race Slide Friction Spring for 19148 and 19185
19148	2590	Shuttle Race Slide Guide (back) with 651E and 19147
19149	1216	Shuttle (inside) Tension Spring for 19312
19156	2582	Thread Take-up Lever for 19157
19157	---	Thread Take-up Lever complete, Nos. 12166, 12409 and 19156
19158	2584	Thread Take-up Spring Nos. 19159 to 19161 for 19162
19159	2584	Thread Guide Body
19160	2584	" " Roller
19161	2584	" " Cap
19162	---	Thread Guide complete (roller) Nos. 905b and 19159 to 19161
19171	1217	Shuttle (outside) Body for 19326
19172	1216	" " Tension Spring for 19313
19185	2590	" Race Slide Guide (front) with 651E and 19147 Nos. 19191 to 19194 for 19195
19191	1146	Tension Plate, for upper tension, with 19231
19192	1146	Tension Releaser
19193	1146	" Releasing Lever (intermediate)
19194	1146	" " " " " Spring
19195	1146	Tension complete (upper) with Tension Release, Nos. 2269, 19191, 19193, 19194, 44209, two each 1547b, 2923, 19192 and four 2921
19197	---	Roller Arm for 24602
19199	---	" " " 24604
19200	---	" " Bracket for 24602 and 24604
19215	2589	Guide, for collars and cuffs, for 44-84 Machine

NO.	PLATE	NAME
19221	1161	Wrench for 1619 (Attachments and Accessories).....
19231	1146	Tension Releasing Lever (intermediate) Hinge Block for 19191.....
19236	—	Feed Lifting Rock Shaft complete, Nos. 16504, 16556 and 19120.....
19256	2581	Needle Bar Trip Lever Connecting Rod Spring Collar with 187F.....
19281	2590	Shuttle Race Slide (outside) for $\frac{1}{2}$ in. to $\frac{1}{8}$ in. gauge, for 44-84 Machine.....
19309	1213	Shuttle Race Needle Guard for 19323 and 24013.....
19310	1217	Shuttle (inside) Bobbin Case Latch and Position Finger for 19312.....
19311	1217	Shuttle (outside) Bobbin Case Latch and Position Finger for 19313.....
19312	1217	Shuttle (inside) Bobbin Case complete for 19324, Nos. 591F, 592E, 2521, 19149, 19310 and 62606.....
19313	1217	Shuttle (outside) Bobbin Case complete for 19325 and 19326, Nos. 591F, 592E, 2521, 19172, 19311 and 62608.....
19315	—	Shuttle Race Body with 19316, for 19323
19316	1213	“ “ Loop Separator for 19315..
19317	1213	“ “ Ring (inside) for 19323 and 24013.....
19318	1213	Shuttle Race Ring (outside) for 19323 and 24013.....
19323	1213	Shuttle Race complete, for $\frac{3}{32}$ in. to $\frac{5}{32}$ in. gauge, Nos. 19309, 19315, 19317, 19318, two each 907D, 1053D, 2533 and four 2532.....
19324	1217	Shuttle (inside) $1\frac{1}{16}$ in. diam., Nos. 19131, 19136 and 19312.....
19325	1217	Shuttle (outside) $1\frac{1}{16}$ in. diam., for $\frac{3}{32}$ in. gauge and above, Nos. 19131, 19137 and 19313.....
19326	1217	Shuttle (outside) $1\frac{1}{16}$ in. diam., for $\frac{1}{2}$ in. to $\frac{1}{4}$ in. gauge, Nos. 19131, 19171 and 19313.....
19327	1220	Face Plate Thread Guard with 12152, for 24919.....
19337	2584	Thread Retainer Thread Guard for 24919
19379	—	Shuttle Race Body for 24013.....
19385	2590	“ “ Slide (outside) for $\frac{3}{32}$ in. gauge and above, for 44-84 Machine ..
19386	2580	Oscillating Rock Shaft for 19387.....

NO.	PLATE	NAME
19387	—	Oscillating Rock Shaft complete, Nos. 4784, 12388 and 19386.....
19388	1208	Oscillating Shaft Crank complete, Nos. 457C, 1518E, 19390 and 19496.....
19389	1208	Oscillating Shaft Crank Slide Block for 19390.....
19390	1208	Oscillating Shaft Crank Slide Block complete for 19388, Nos. 229D, 969C, 12424 and 19389.....
19452	2581	Needle Bar Coupling Pin for 62590, 62595 and 62597.....
19454	2581	Needle Bar Coupling Pin Lever Shaft for 19457.....
19456	2581	Needle Bar Coupling Pin Lever Shaft Crank for 19457.....
19457	—	Needle Bar Coupling Pin Lever Shaft complete, Nos. 2273, 19454 and 19456
19460	2581	Needle Bar Thread Guide for 62590, 62595 and 62597.....
19462	2580	Needle Bar Trip Lever Pitman.....
19496	—	Oscillating Shaft Crank for 19388.....
20188	2582	Needle Bar Crank with 858C and 1065C..
20197	2578	Crank Connecting Rod with 20198 and two 896E.....
*20198	—	Crank Connecting Rod Cap for 20197.....
22003	2578	Wrench for 1735 (Attachments and Accessories).....
23474	2581	Needle Bar Stop Collar Washer (rawhide)
23548	2581	“ “ “ Plug (fibre) for 24930..
24013	2585	Shuttle Race complete, for $\frac{1}{4}$ in. gauge and above, Nos. 19309, 19317, 19318, 19379, two each 907D, 1053D, 2533 and four 2532.....
24035	2588	Feed and Feed Lifting Eccentric with 448C, for 44-84 Machine.....
24036	2588	Feed and Feed Lifting Eccentric Sleeve for 44-84 Machine.....
24037	2580	Feed Forked Connection for 44-84 Machine.....
24079	5877	Drip Pan with four 1 in. wire nails.....
24129	2582	Thread Take-up Crank for 44-40 Machine
24131	2582	Arm Oil Tube with 29599, for oiling 12197 and 24035.....
24296	2579	Balance Wheel (power) light rim, $2\frac{3}{16}$ in. pulley, with two 448C.....
24297	2579	Balance Wheel Oil Cover.....

NO.	PLATE	NAME
24376	—	Feed Rock Shaft complete, Nos. 16506 and 29633
24592	2586	Feed Dog with 19118, for $\frac{3}{32}$ in. to $\frac{11}{64}$ in. gauge
24593	2586	Throat Plate for 24592
24594	2586	Feed Dog with 19118, for $\frac{3}{16}$ in. to $\frac{1}{4}$ in. gauge, for 44-40 Machine and for shirt collars for 44-84 Machine
24595	2586	Throat Plate for 24594
24596	2587	Feed Dog with 19118, for $\frac{3}{16}$ in. to $\frac{15}{32}$ in. gauge, for 44-84 Machine
24597	2587	Throat Plate for 24596
24598	2587	Feed Dog with 19118, for $\frac{1}{2}$ in. to $\frac{7}{32}$ in. gauge, for 44-84 Machine
24599	2587	Throat Plate for 24598
24600	2586	Presser Foot, for plain work
24601	2584	Roller Needle Guard (round) for 24602 and 24604
24602	—	Roller Presser complete, $1\frac{1}{4}$ in. roller, for $\frac{3}{32}$ in. to $\frac{1}{4}$ in. gauge, for 44-40 Machine, Nos. 171E, 176D, 440E, 1549J, 1903, 7556, 19197, 19200, 24601, two 316F and three 1547J
24604	2584	Roller Presser complete, $1\frac{1}{2}$ in. roller, for $\frac{3}{32}$ to $\frac{1}{4}$ in. gauge, for 44-40 Machine, Nos. 171E, 176D, 440E, 1549J, 1875, 7556, 19199, 19200, 24601, two 316F and three 1547J
24735	2588	Feed Dog with 19118, for $\frac{7}{8}$ in. to 1 in. gauge, for 44-84 Machine
24736	2588	Throat Plate for 24735
*24916	—	Arm with 11104
*24917	—	Bed
24918	—	Face Plate for 24919
24919	2579	Face Plate complete, Nos. 185C, 9544, 9545, 19327, 19337, 24918 and two 9543
24923	2582	Needle Bar Connecting Link with 794E
24926	2581	“ “ Coupling Pin Lever
24927	2581	“ “ “ “ “ Hub with 207E
24928	2581	Needle Bar Coupling Pin Lever Shaft Bracket
24929	2581	Needle Bar Coupling Pin Stop
24930	2581	“ “ Stop with 23548
24931	2581	“ “ “ Bracket with 191E
24932	2581	“ “ “ “ Bar
24933	2581	“ “ “ Collar with 175D

NO.	PLATE	NAME
24935	2580	Needle Bar Trip Lever
24936	2580	“ “ “ “ Connecting Rod
24937	2592	“ “ “ “ Stop Screw Bracket
24938	2585	“ Clamp, for left hand needle, with 250E and 620C, for $\frac{7}{32}$ in. gauge and above, for 62590
24939	2590	Lifting Lever with 448C, for 24941
24940	2590	“ “ Connecting Rod for 24941
24941	—	Knee Lifter complete, Nos. 76D, 766D, 802D, 1521E, 2777, 5598, 12240, 12241, 12416, 24939, 24940 and two 178E
25478	2581	Needle Bar Stop Spring
26026	1161	Screw Driver, machine (Attachments and Accessories)
26276	2586	Presser Foot Hinge Pin for 62693 and 62695
26485	1161	Screw Driver, shuttle tension (Attachments and Accessories)
27302	1162	Bobbin Winder Frame for 27651
27303	1220	“ “ “ Spring for 27651
27306	1162	“ “ Spool Pin for 27308
27307	1162	“ “ “ Stand for 27308
27308	1162	Bobbin Winder Spool Stand complete for 27588, Nos. 418E, 1562J, 2106, 10141, 11241, 27306, 27307 and two each 2455 and wood screws 1 in. No. 10
27538	1162	Bobbin Winder Spindle with 15072, for 27651
27552	1162	Bobbin Winder Base for 27651
27553	1162	“ “ Pulley for 27651
27587	1162	“ “ Stop Latch for 27651
27588	—	Bobbin Winder (swinging automatic, right hand) complete for 19131, Nos. 27308 and 27651
27618	2594	Tape Holder Stand with 138B, for 60926
27623	5571	Thread Unwinder Spool Pin for 41435
27651	1162	Bobbin Winder for 27588, Nos. 35D, 1620J, 27302, 27303, 27538, 27552, 27553, 27587, 50356D and two wood screws 1 in. No. 7
27739	5571	Thread Unwinder Thread Cone (wood) for 41438
27940	5571	Thread Unwinder Spool Stand with 453C, for 41438
28084	2591	Machine Rest Pin (Attachments and Accessories)

NO.	PLATE	NAME
29599	2582	Arm Oil Tube Packing (felt) for 11419, 12454 and 24131.....
29633	2583	Feed Rock Shaft Crank with 1573, for 24376.....
35143	1161	Tweezers, 4 in. (Attachments and Accessories).....
36565	1161	Oiler (copper plated) with 36566 (Attachments and Accessories).....
36566	1161	Oiler Spout, 9 in. long, with 120117, for 36565.....
41400	2580	Machine Rest Pin (wood) 31 $\frac{1}{8}$ in. long (Attachments and Accessories).....
41434	5571	Thread Unwinder Spool Rest for 60697..
41435	—	“ “ “ “ 60697 with three 27623, for 41438.....
41438	5571	Thread Unwinder complete, for three large spools or three large cones of thread, Nos. 27940, 41435, 41632, 41640 and three each 27739, 41514 and wood screws 1 in. No. 12.....
41514	5571	Thread Unwinder Spool Weight, 4 in. diam., with 41515, for 41438.....
41515	2592	Thread Unwinder Spool Weight Centre Pin for 41514.....
41569	2592	Thread Unwinder Thread Guard Eyelet for 41632.....
41632	5571	Thread Unwinder Thread Guard with 208E and three 41569, for 41438.....
Nos. 41637 to 41639 for 41640		
41637	5571	Thread Unwinder Thread Guard Rod (lower).....
41638	5571	Thread Unwinder Thread Guard Rod (upper).....
41639	5571	Thread Unwinder Thread Guard Rod Coupling with two 456c.....
41640	—	Thread Unwinder Thread Guard Rod complete, 30 in. long, for 41438, Nos. 41637 to 41639.....
41832	2594	Tape Holder Rod for 60926.....
41834	2594	“ “ Spindle Bracket with 446F and 448E, for 60926.....
41875	2593	Tape Holder Spindle Cone (inside) with 249b, for 60926.....
41876	2593	Tape Holder Spindle Cone (outside) with 793b, for 60926.....

NO.	PLATE	NAME
43976	2578	Feed Lifting Rock Shaft Crank Connecting Rod with 43977 and two 966e.....
*43977	—	Feed Lifting Rock Shaft Crank Connecting Rod Cap for 43976.....
44139	2592	Machine Hinge Plate for 44140 and 44180
44140	—	Machine Hinge complete, Nos. 12361, 44139 and wood screw 1 $\frac{1}{4}$ in. No. 14 (Attachments and Accessories).....
44180	—	Machine Hinge complete, Nos. 687E, 6055, 12361 and 44139 (Attachments and Accessories).....
44209	—	Tension Screw Stud 916c with 1560c, for 19195.....
50257E	2591	Needle Bar Connecting Stud Screw (upper) for 62590, 62595 and 62597.....
50356D	2591	Bobbin Winder Frame Hinge Screw for 27651.....
52838	2593	Tape Guide with 759b, for 62686.....
52839	2593	“ “ Block with 460c, for 62686..
52840	2593	“ “ Pin for 62684.....
56813	—	Feed Bar Screw Centre 313c with 1519.....
56814	—	“ Lifting Rock Shaft Screw Centre 307c with 1513.....
56814	—	Feed Rock Shaft Screw Centre 307c with 1513.....
56848	—	Bell Crank 5596 with 5599 and 5601, for 5598.....
60697	—	Thread Unwinder Spool Rest 41434 with 1119c and three 155c, for 41435.....
60925	2594	Tape Holder Spindle for 60926.....
60926	2594	Tape Holder complete for 44-84 Machine, Nos. 13211, 27618, 41832, 41834, 41875, 41876 and 60925.....
*62589	2580	Needle Bar, for left hand needle, with 4766, for 62590, 62595 and 62597.....
62590	—	Needle Bar complete, for $\frac{3}{32}$ in. gauge and above, Nos. 665b, 930e, 19452, 19460, 24938, 50257e, 62589, 62591, 62593, 62594 and two 207F.....
62591	2583	Needle Bar Collar for 62590, 62595 and 62597.....
*62592	—	Needle Bar Connecting Stud for 62593..
62593	2583	Needle Bar Connecting Stud complete for 62590, 62595 and 62597, Nos. 1904 and 62592.....
*62594	2580	Needle Bar, for right hand needle, with 620c, for 62590, 62595 and 62597.....

NO.	PLATE	NAME
62595	2580	Needle Bar complete, for $\frac{3}{32}$ in. to $\frac{9}{64}$ in. gauge, Nos. 665b, 930e, 19152, 19460, 50257e, 62589, 62591, 62593, 62594, 62596 and two 207F
*62596	2585	Needle Clamp, for left hand needle, with 994f, for $\frac{3}{32}$ in. to $\frac{9}{64}$ in. gauge, for 62595
62597	—	Needle Bar complete, for $\frac{5}{32}$ in. to $\frac{13}{64}$ in. gauge, Nos. 665b, 930e, 19152, 19460, 50257e, 62589, 62591, 62593, 62594, 62598 and two 207F
62598	2585	Needle Clamp, for left hand needle, with 620c and 944e, for $\frac{5}{32}$ in. to $\frac{13}{64}$ in. gauge, for 62597
62606	—	Shuttle (inside) Bobbin Case for 19312
62608	—	" (outside) Bobbin Case for 19313
Nos. 62684 to 62695 for 44-84 MACHINE		
62684	2593	Tape Guide Arm with two 52840, for 62686
62685	2593	" " " Bracket with 1447r, for 62686
62686	—	Tape Guide complete, Nos. 1906, 52838, 52839, 62684 and 62685
62687	2589	Presser Foot (tube) for taping
62688	2589	" " for shirt collars
62689	2589	Throat Plate for 19215 for 24594
62690	2589	Presser Foot, slotted in front of needle holes, for tape
62691	—	Presser Foot Plate for 62693
62692	—	" " Shank for 62693 and 62695
62693	2586	Presser Foot (hinged) complete, Nos. 26276, 62691 and 62692
62694	—	Presser Foot Plate for 62695
62695	2589	Presser Foot (hinged) slotted in front of needle holes, for tape, complete, Nos. 26276, 62692 and 62694
120117	2580	Oiler Spout Washer (leather) for 36566
120225	2588	Presser Foot, for braiding, for 44-84 Machine
200056e	3471	Bobbin Winder Stop Latch Screw for 225436
200082b	3471	Bobbin Winder Tension Bracket Screw for 225436
200299n	3471	Bobbin Winder Stop Latch Trip Lever Hinge Screw for 225436
200380c	3471	Bobbin Winder Pulley Set Screw for 202473
201499b	3471	Bobbin Winder Tension Stud for 225461

NO.	PLATE	NAME
201572b	3471	Bobbin Winder Tension Stud Thumb Nut for 225462
202104	3471	Bobbin Winder Tension Bracket Screw Washer for 225436
202277	3471	Bobbin Winder Frame Oil Packing (wick) for 225453
202407	3471	Bobbin Winder Tension Spring for 225462
202473	3470	" " Pulley with 200380c, for 225436
202478	3471	Bobbin Winder Stop Latch Trip Lever for 225436
225436	3469	Bobbin Winder (swinging automatic, right hand) complete for 19431, for power table, Nos. 200056e, 200082b, 200299n, 202404, 202473, 202478, 225444, 225452 to 225456, 225458 to 225460, 225462, 225463 and two wood screws $\frac{3}{4}$ in. No. 43 R. H. B.
225438	3471	Bobbin Winder Frame Oil Well Cap for 225453
*225443	—	Bobbin Winder Spindle for 225452
225444	3471	" " Stop Latch for 225436
*225451	—	" " Bobbin Holder for 225452
Nos. 225452 to 225456 for 225436		
225452	3470	Bobbin Winder Spindle 225443 with 225451
225453	3470	" " Frame with 202277 and 225438
225454	3471	Bobbin Winder Frame Hinge Pin
225455	3471	" " " Spring
225456	3471	" " " " Plunger
Nos. 225458 to 225460 for 225436		
225458	3471	Bobbin Winder Stop Latch Thumb Lever
225459	3471	" " " " " " " " Hinge Stud
225460	3471	Bobbin Winder Stop Latch Thumb Lever Joint Stud
225461	3471	Bobbin Winder Tension Bracket with 201499b, for 225462
225462	—	Bobbin Winder Tension Bracket complete for 225436, Nos. 201572b, 202407, 225464 and two 2102
225463	3469	Bobbin Winder and Tension Bracket Base for 225436

PLATE 782—FULL SIZE

**ILLUSTRATIONS OF PARTS
FOR
MACHINES
Nos. 44-40 and 44-84**

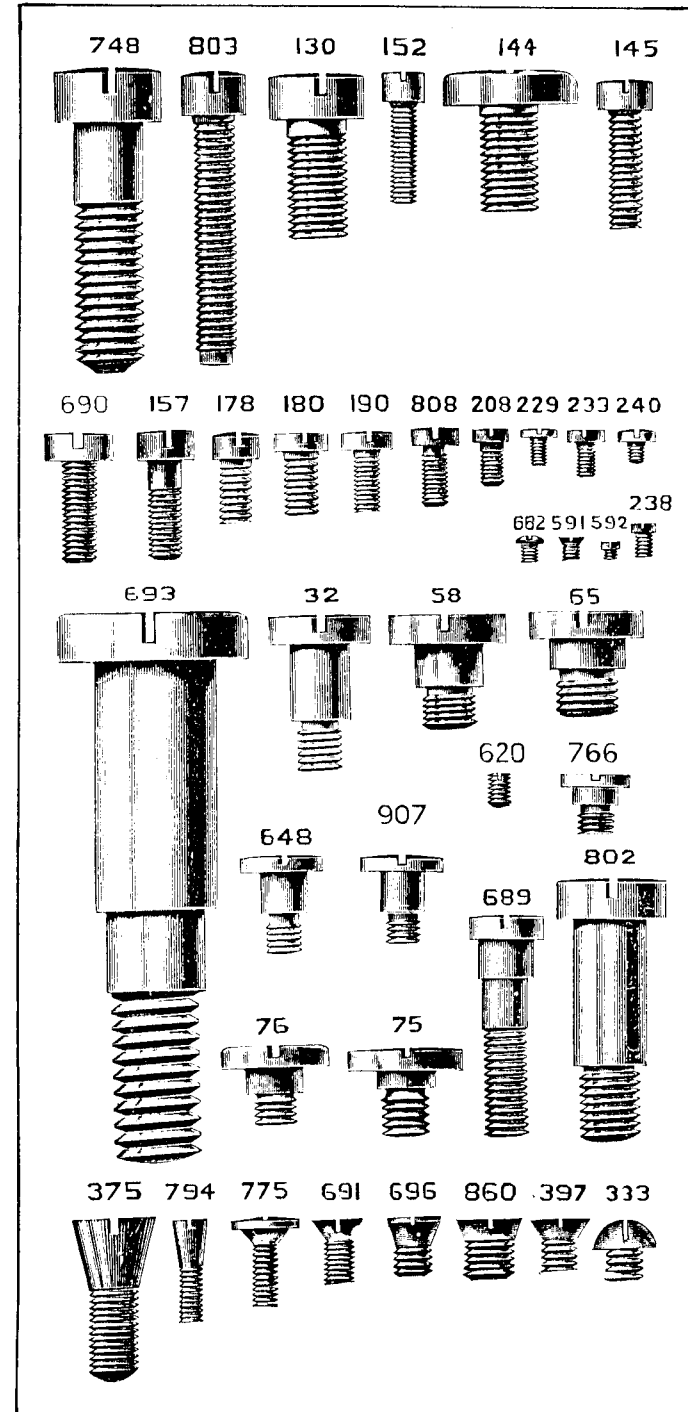


PLATE 783—FULL SIZE

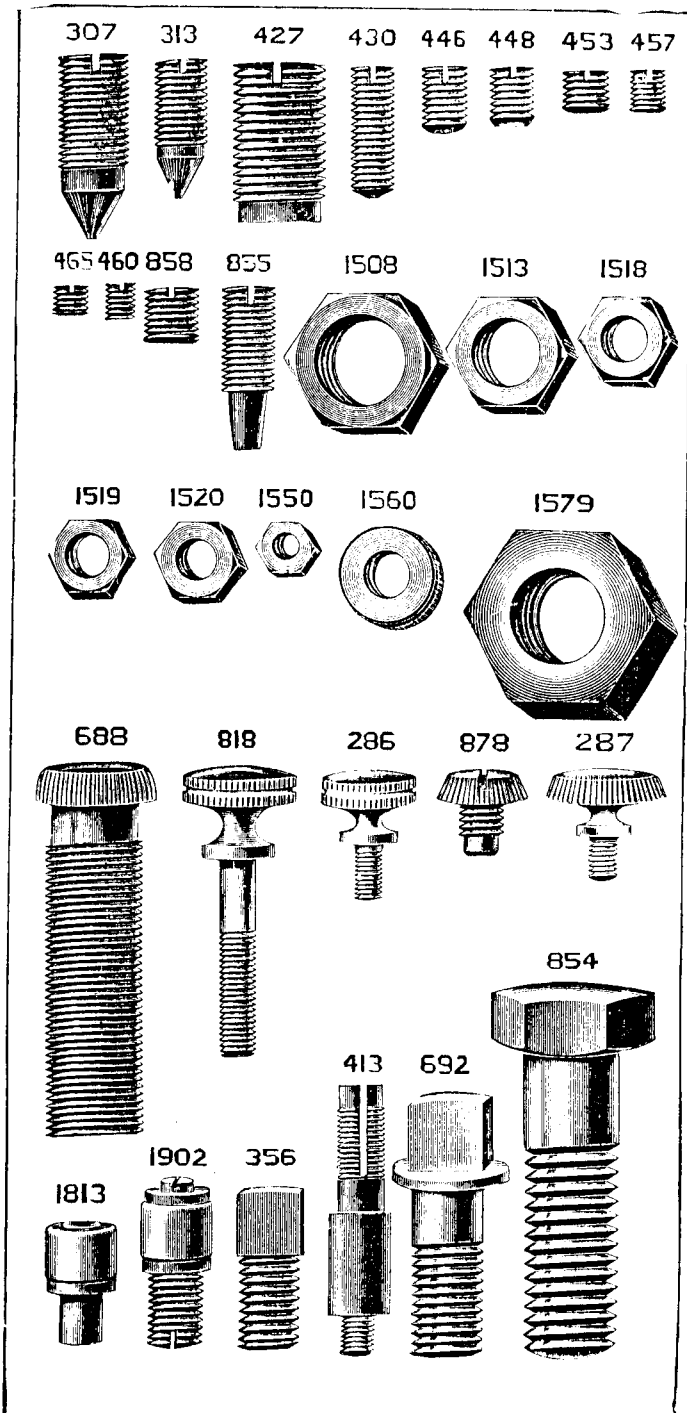


PLATE 1145—FULL SIZE

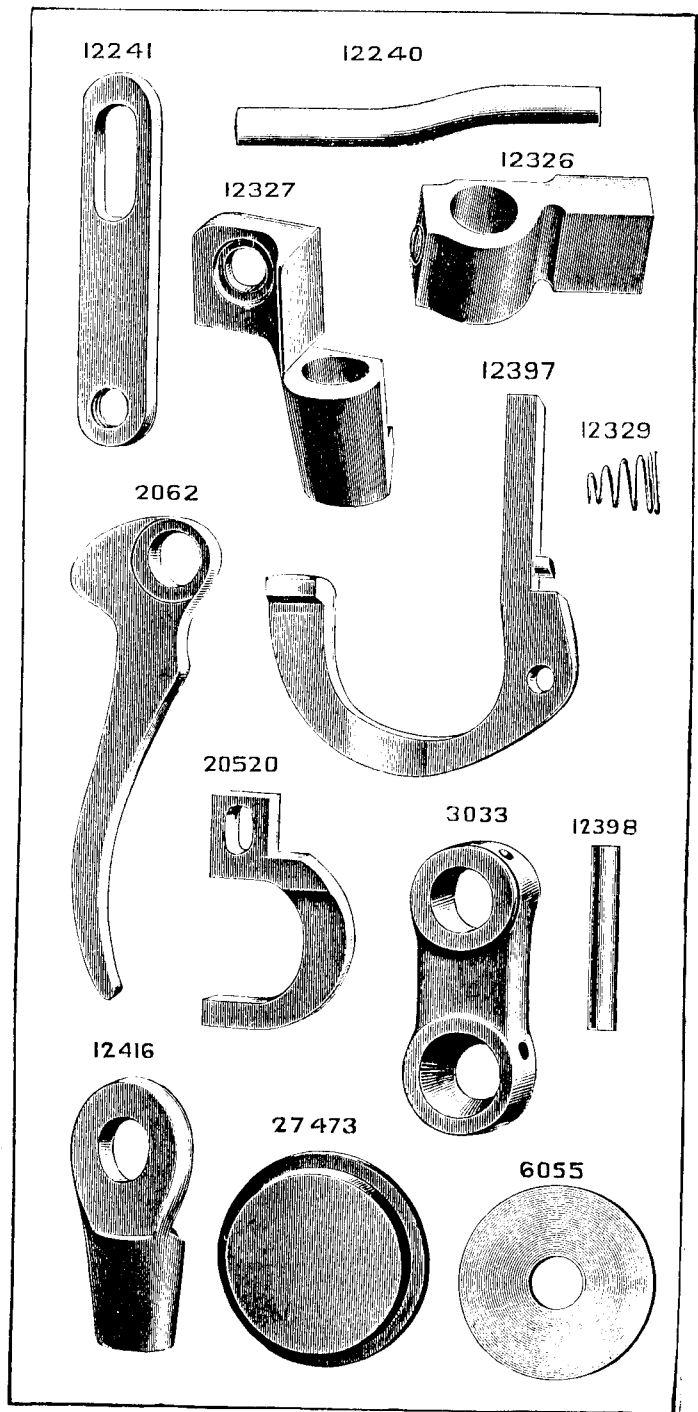


PLATE 1146—FULL SIZE

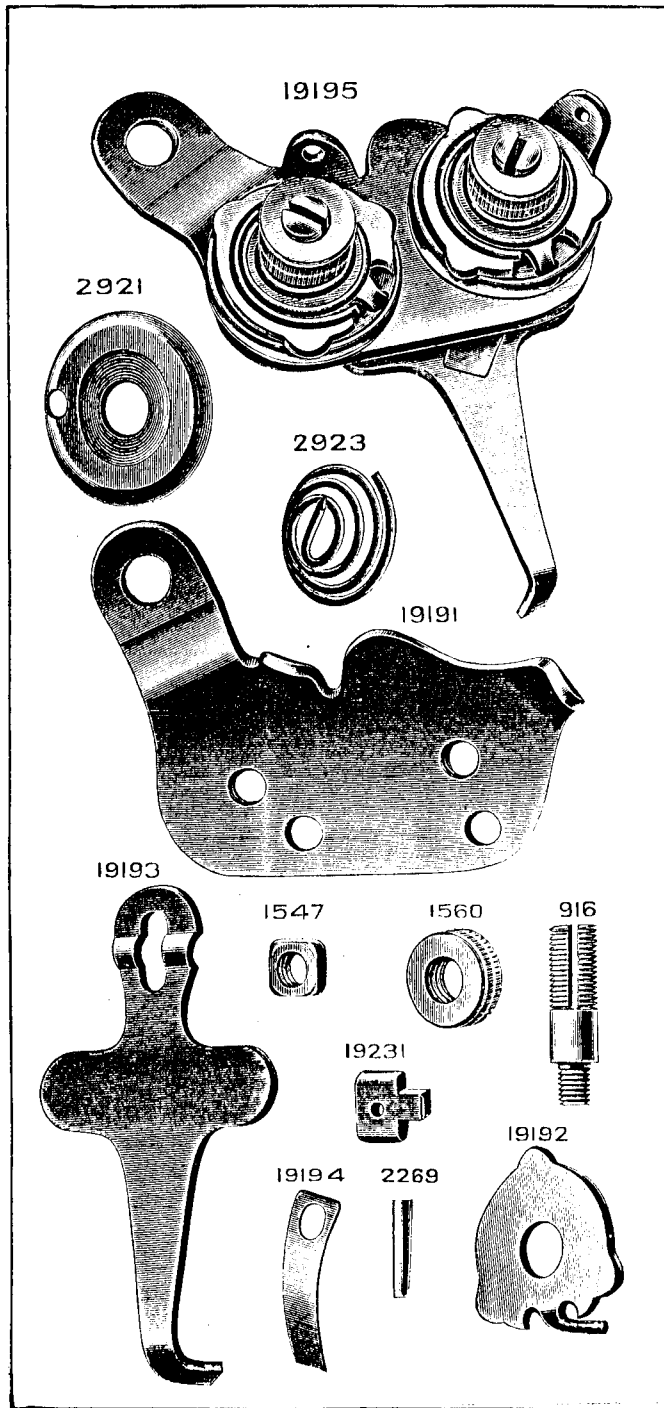


PLATE 1161—ONE-HALF SIZE

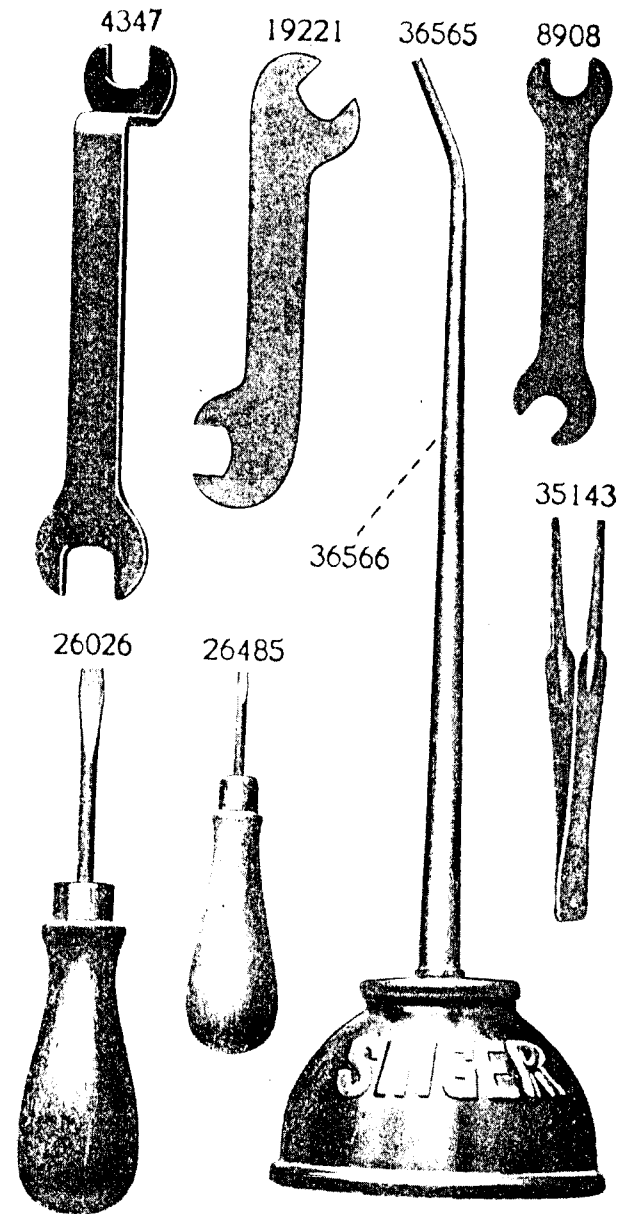


PLATE 1162—ONE-HALF SIZE

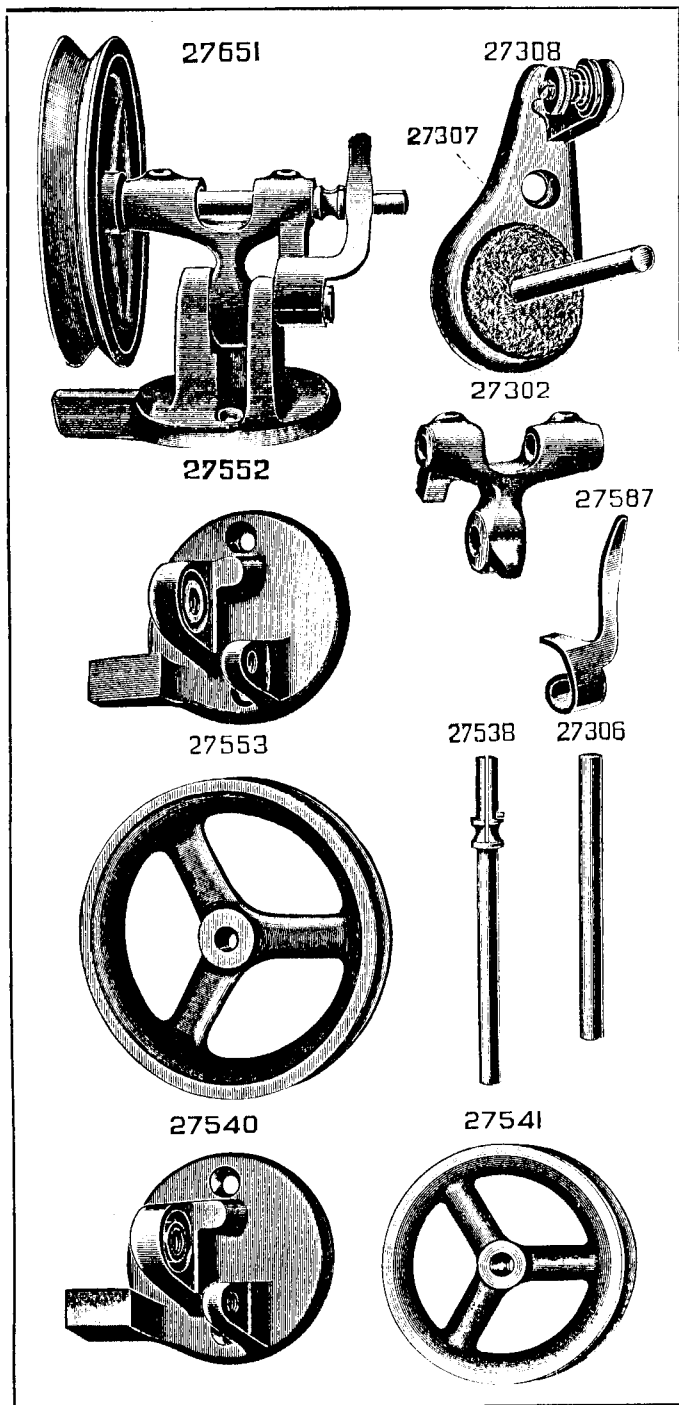


PLATE 1208—FULL SIZE

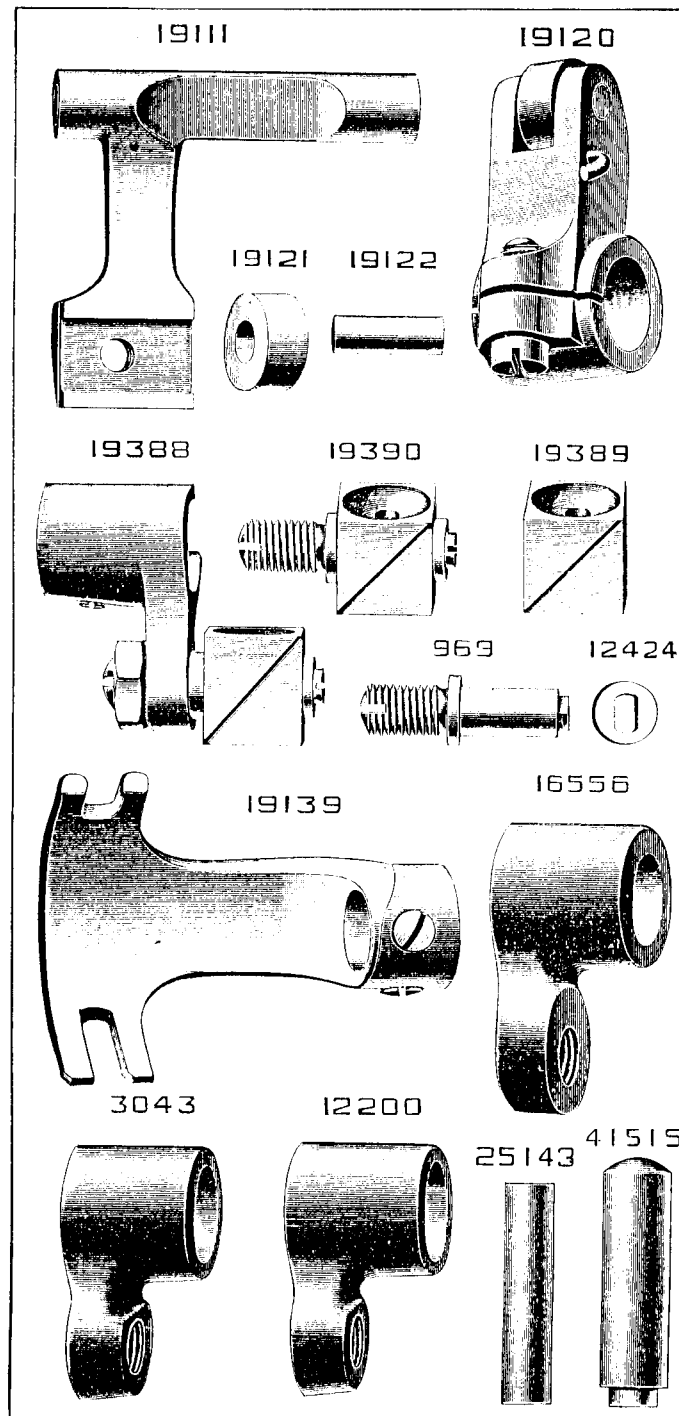


PLATE 1213—FULL SIZE

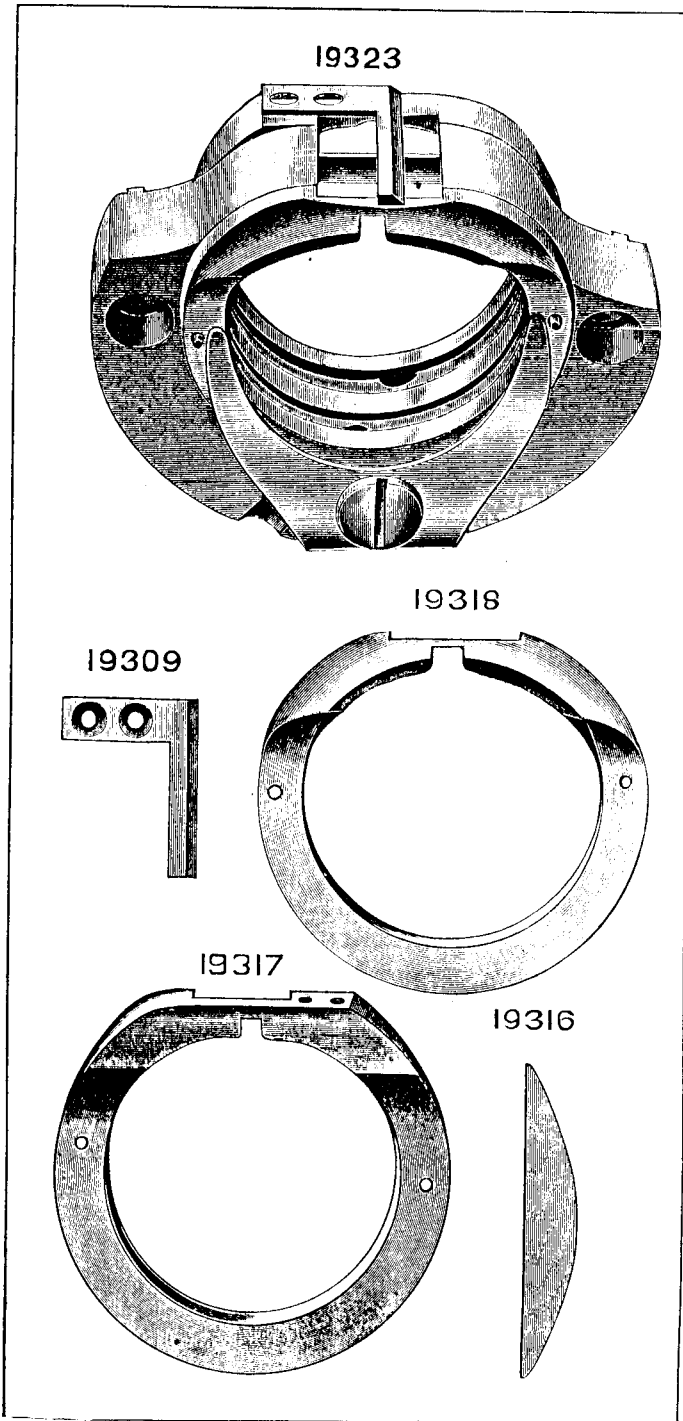


PLATE 1216—FULL SIZE

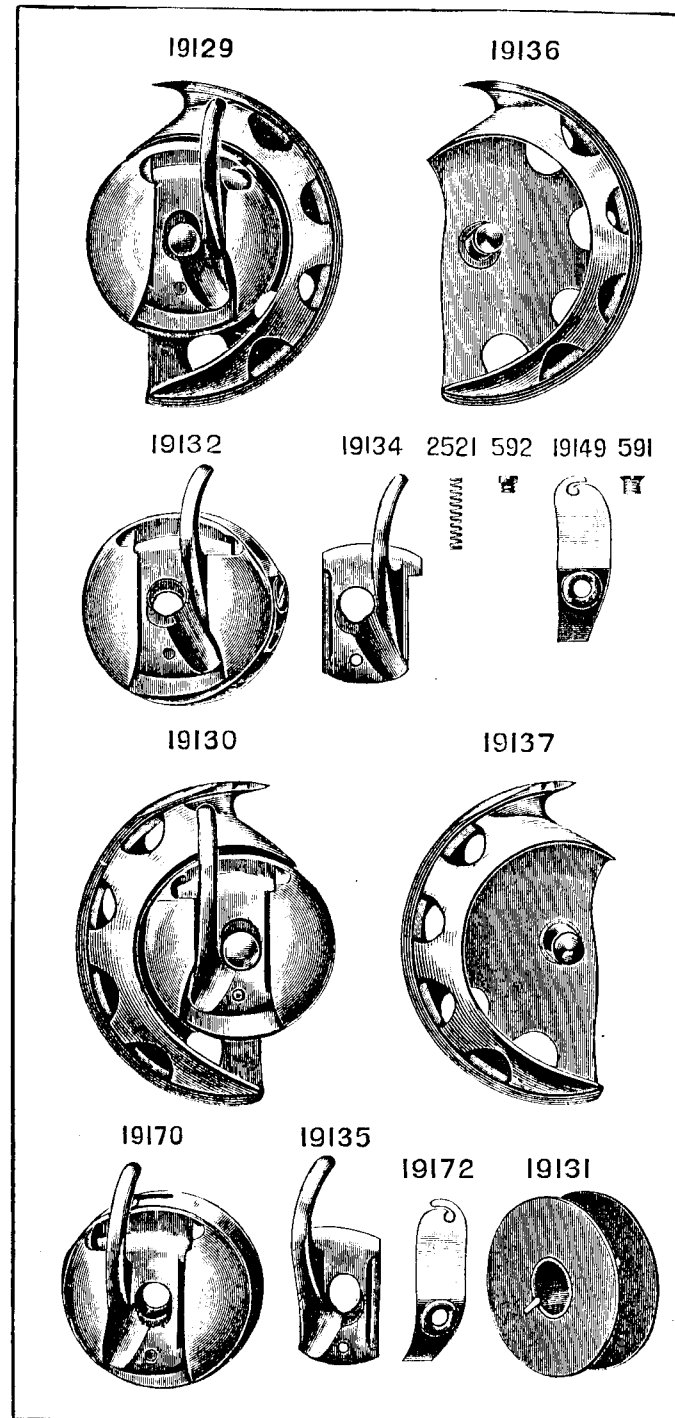


PLATE 1217—FULL SIZE

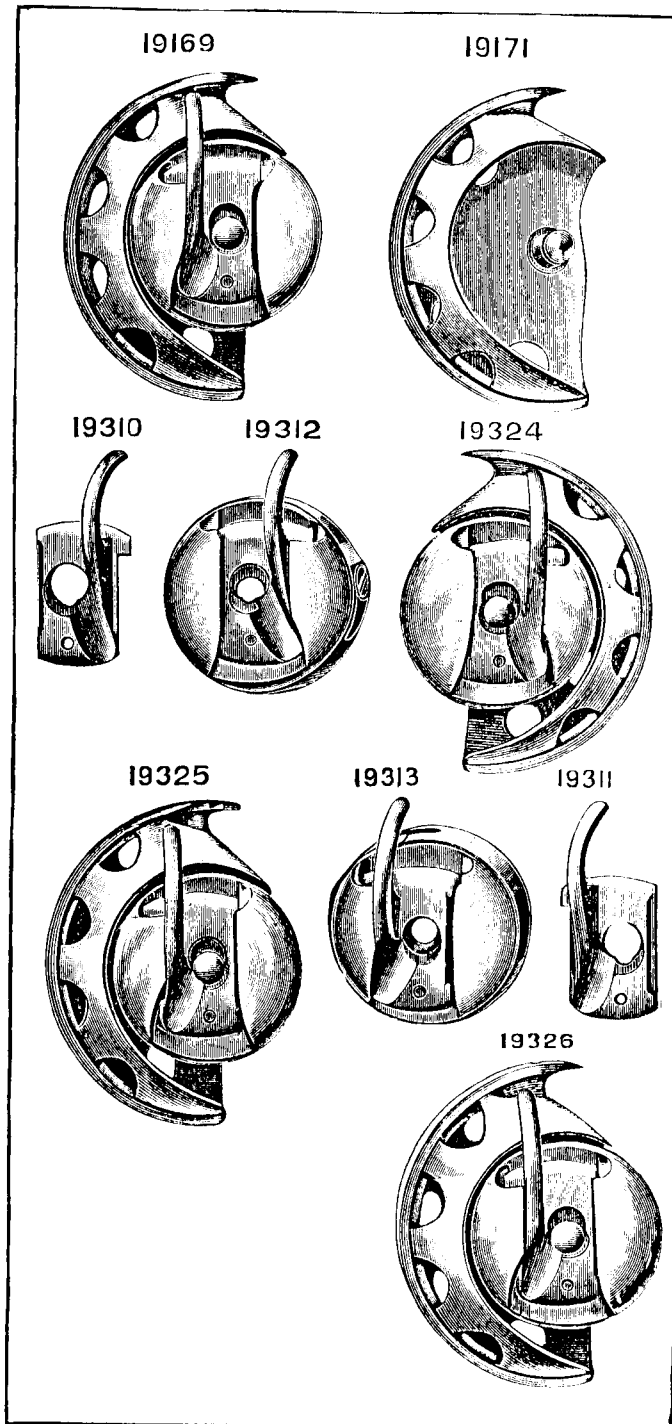


PLATE 1220—FULL SIZE

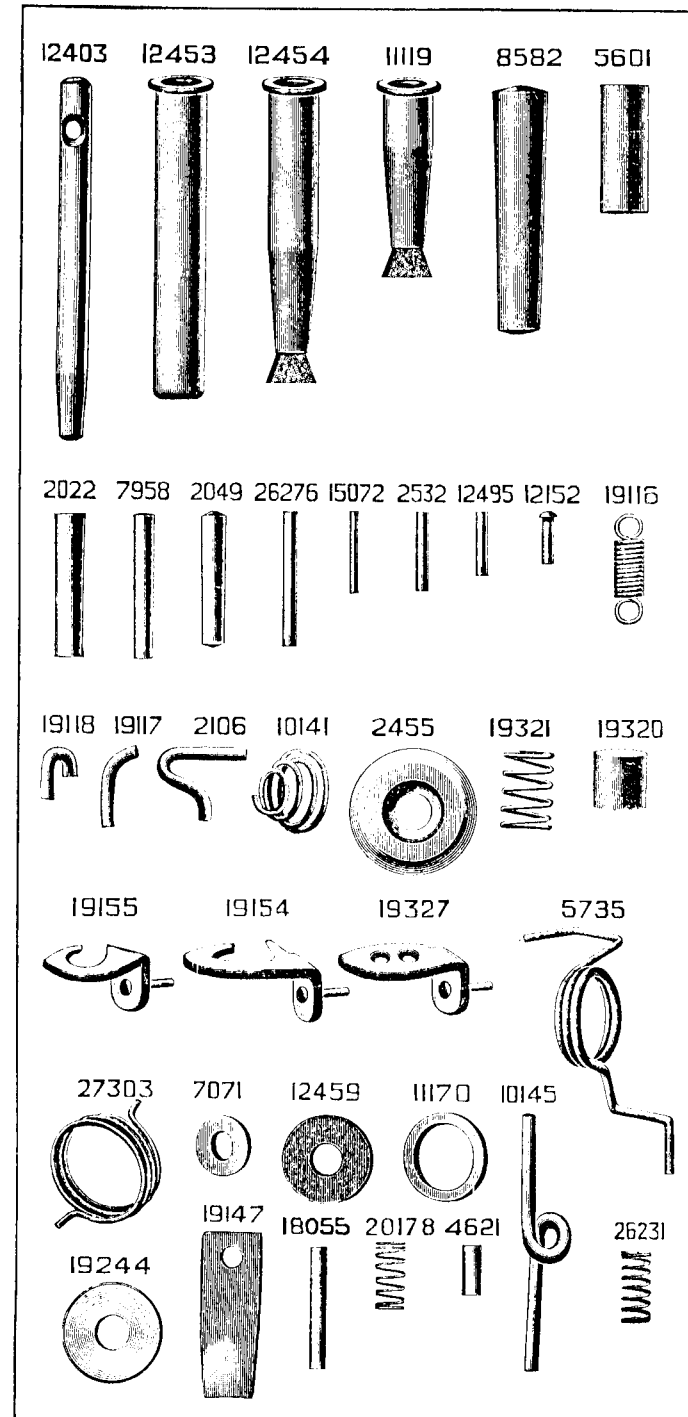


PLATE 1221—FULL SIZE

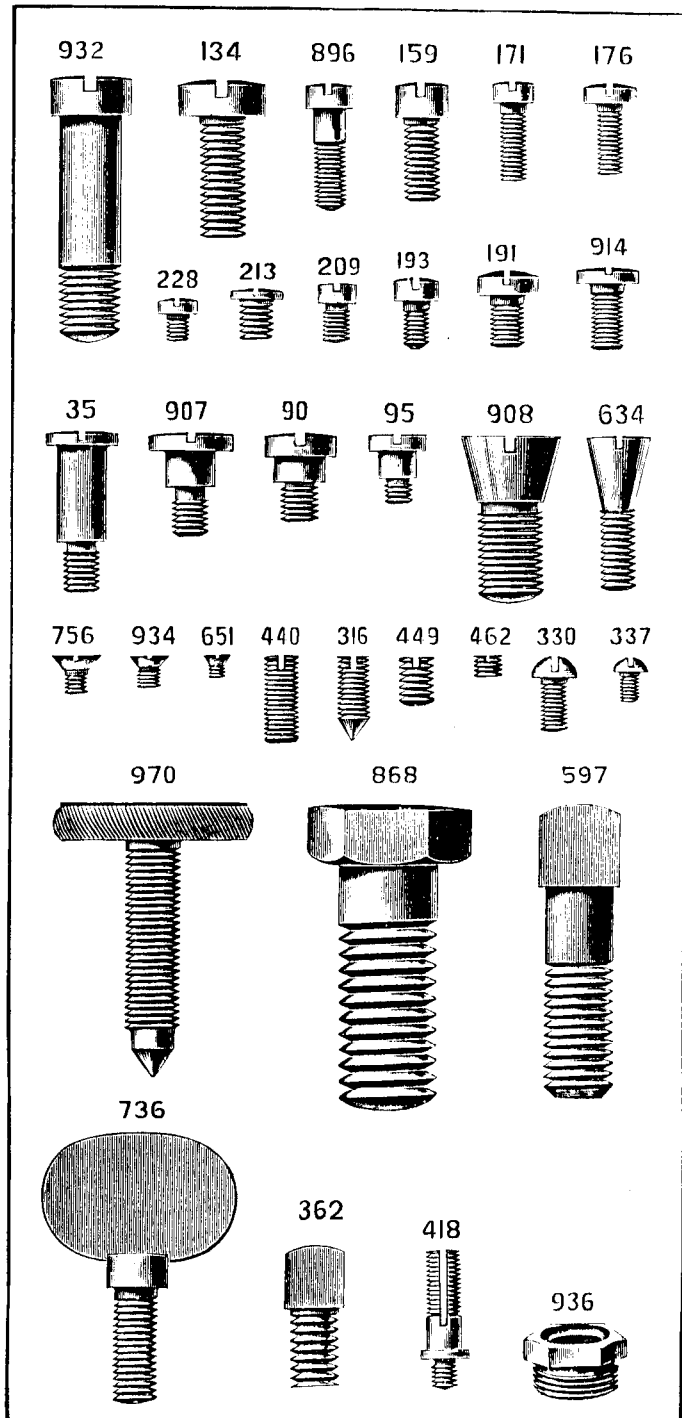


PLATE 2578—ONE-HALF SIZE

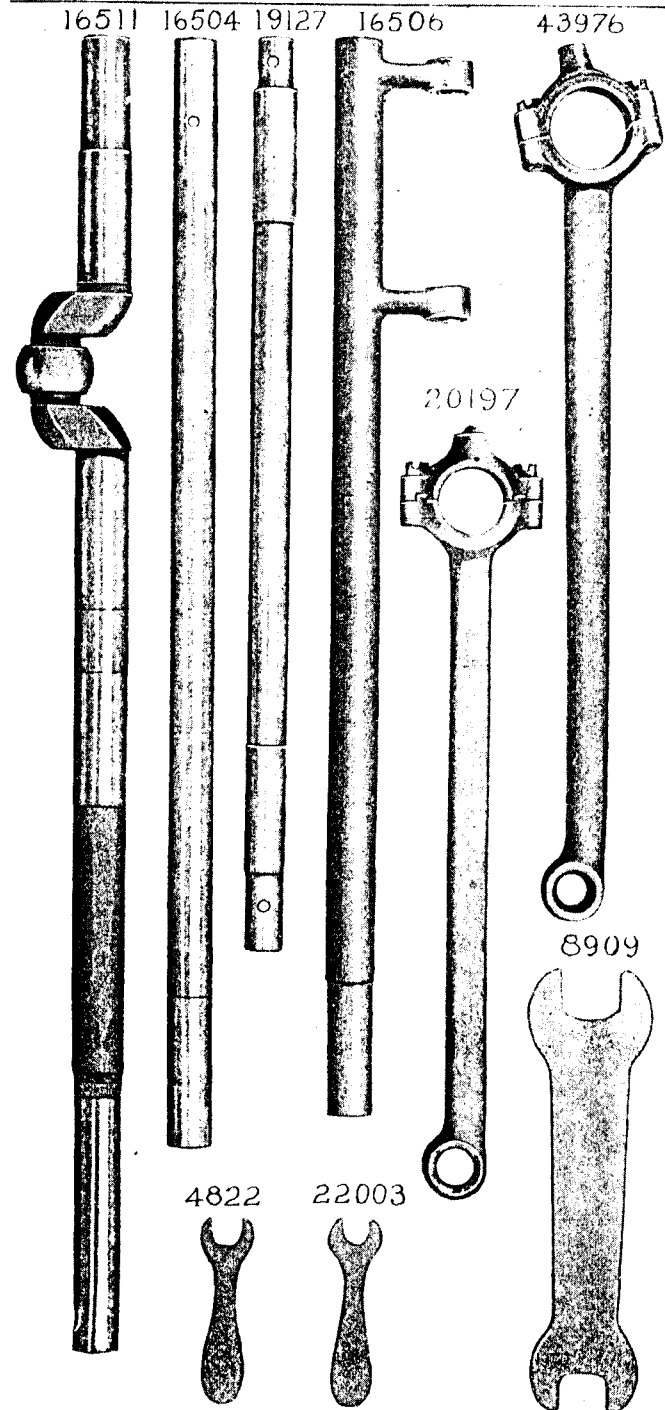


PLATE 2579—ONE-HALF SIZE

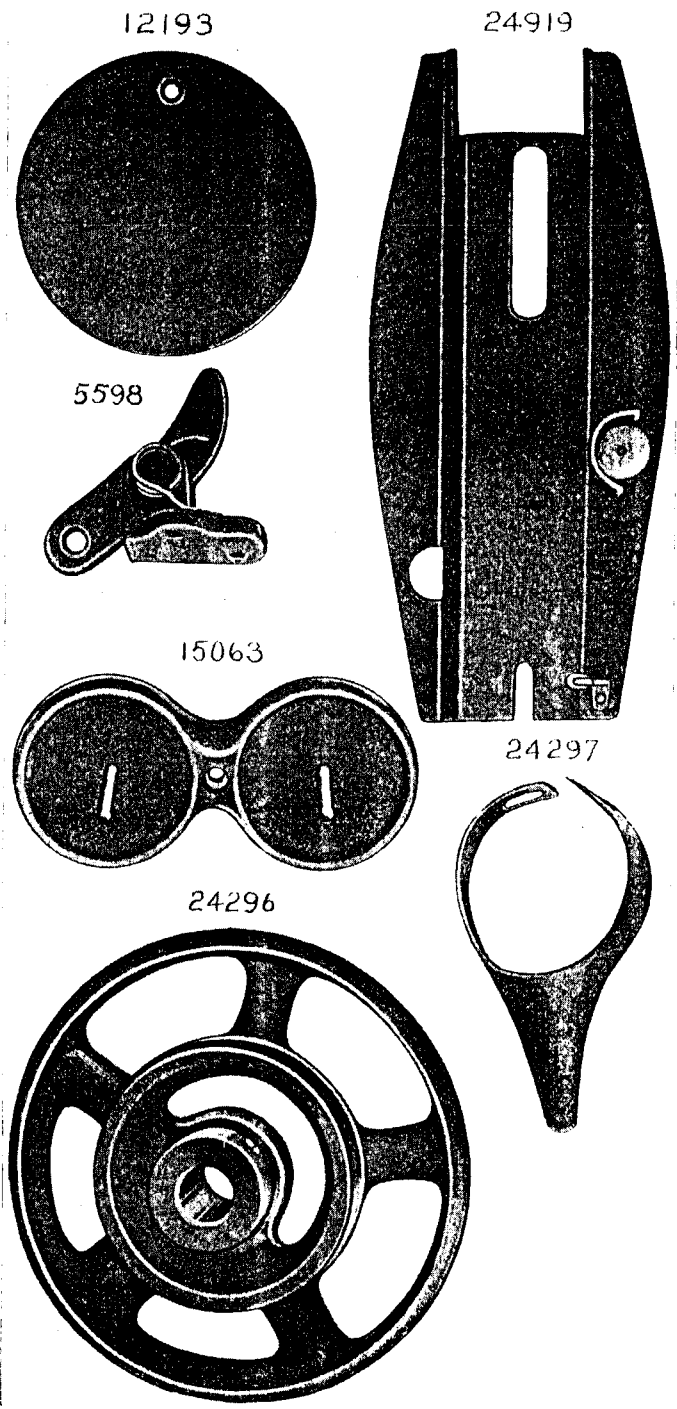


PLATE 2580—ONE-HALF SIZE

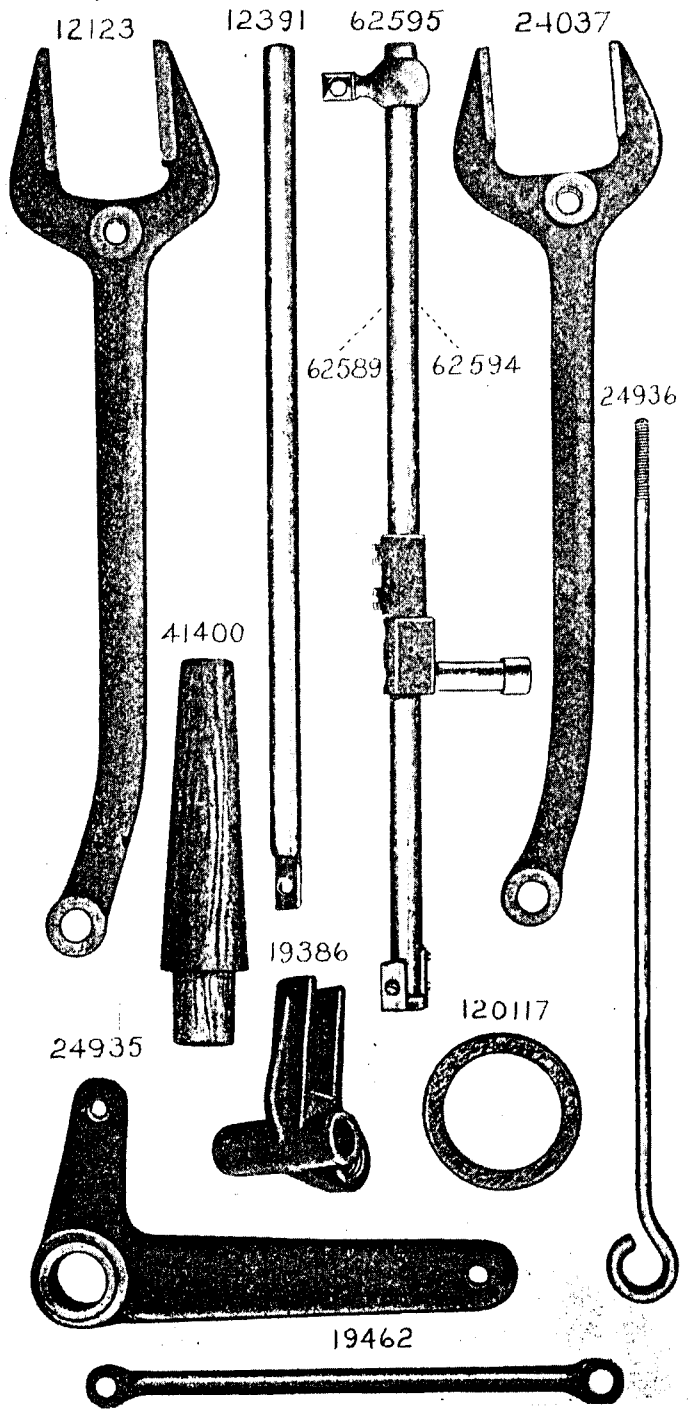


PLATE 2581—FULL SIZE

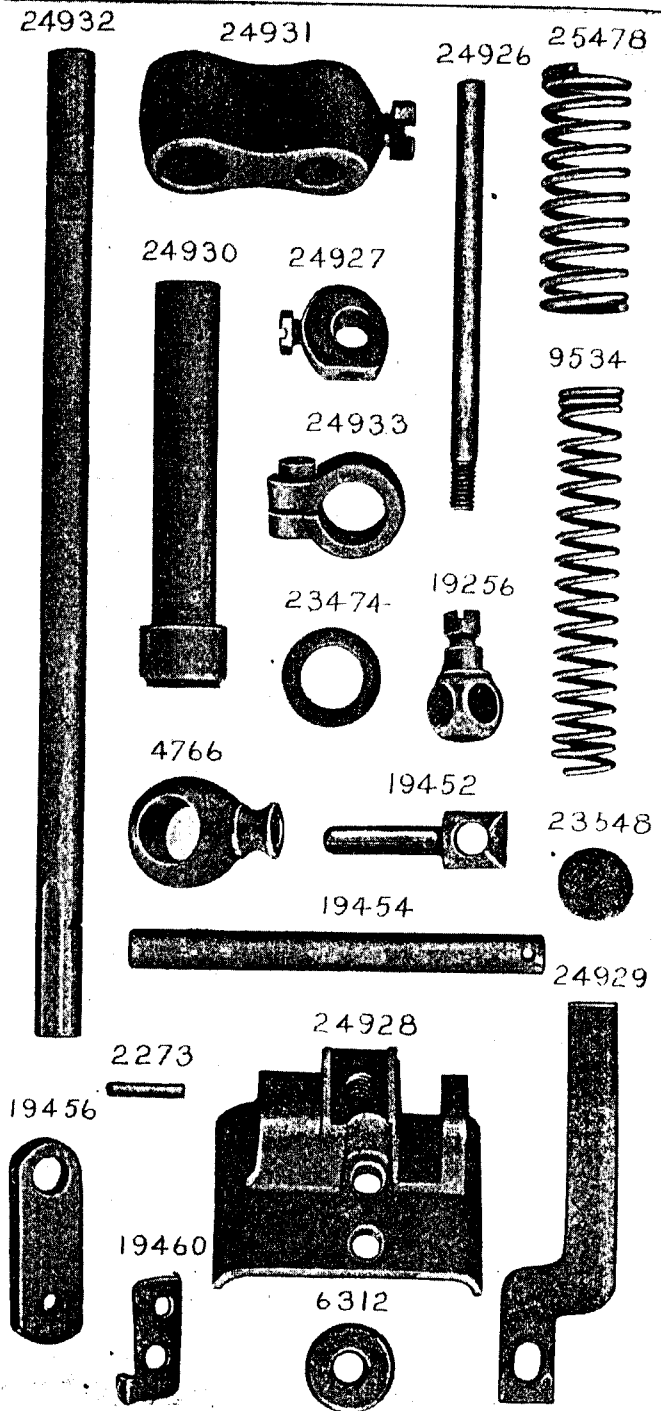


PLATE 2582—FULL SIZE

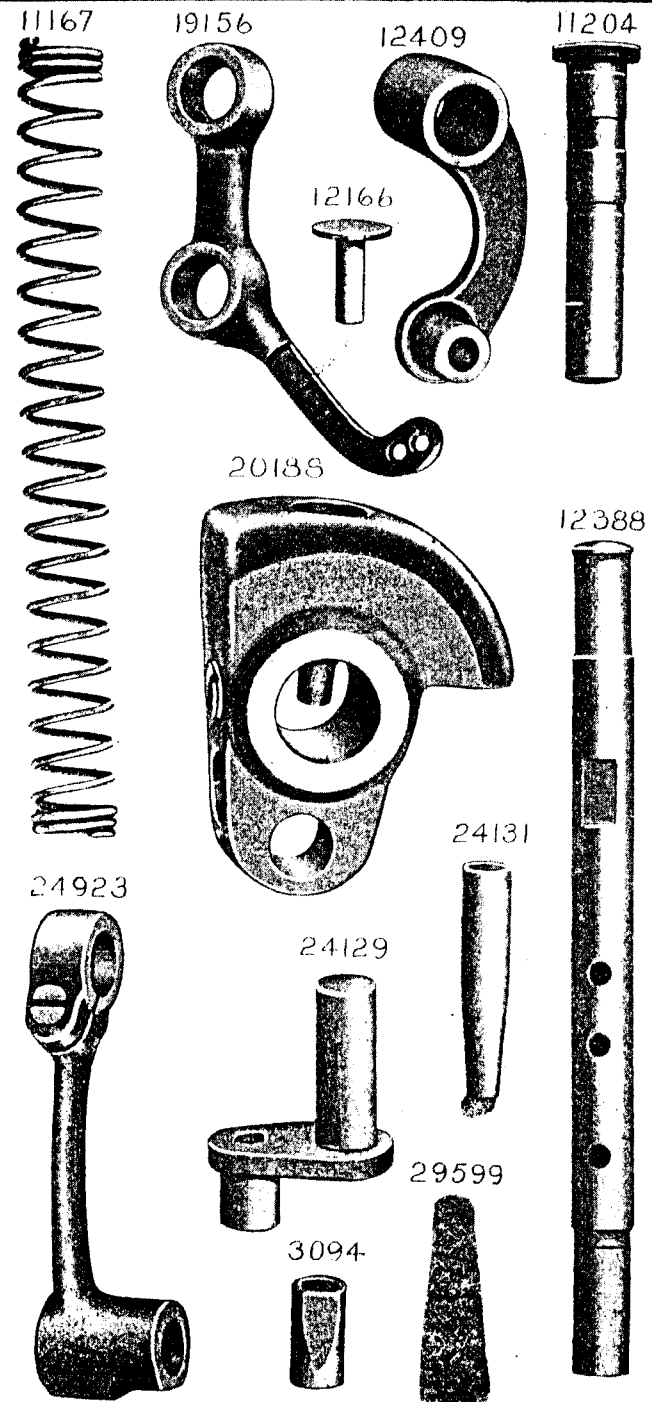
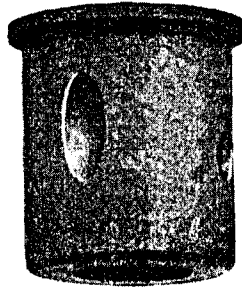
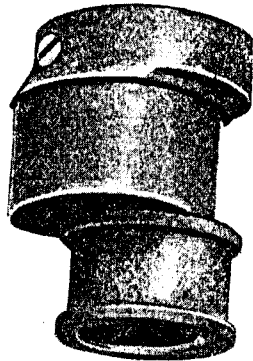


PLATE 2583—FULL SIZE

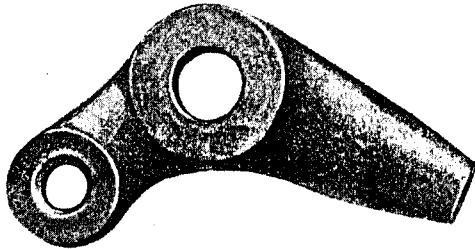
12357



12197



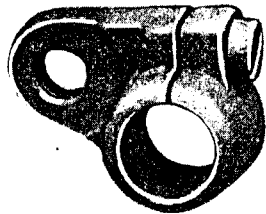
3039



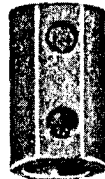
1904



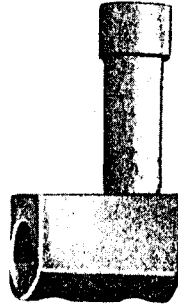
29633



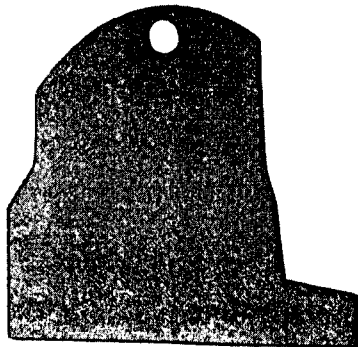
62591



62593



12480



11241

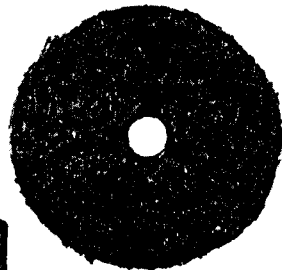
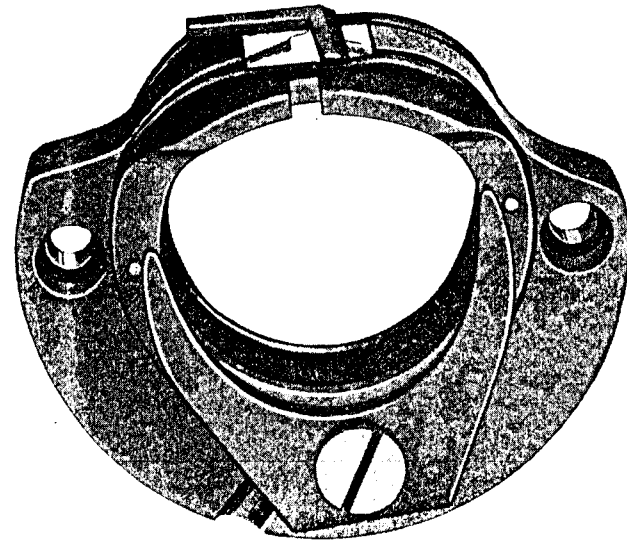


PLATE 2585—FULL SIZE

24013



62596



62598



24938



2533

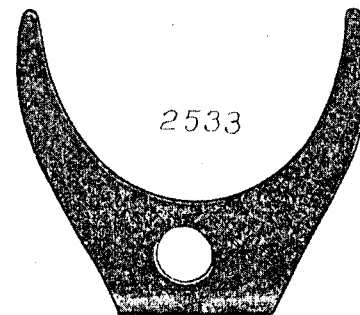


PLATE 2584—FULL SIZE

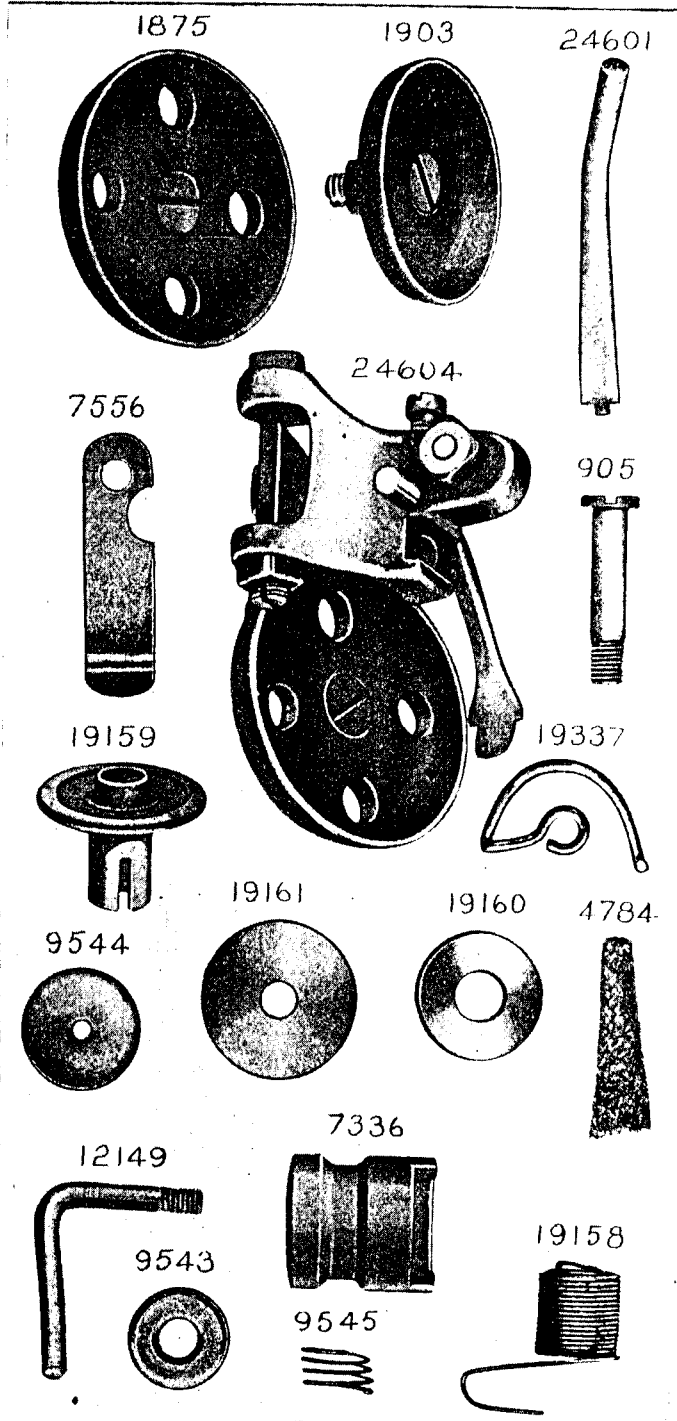


PLATE 2587—FULL SIZE

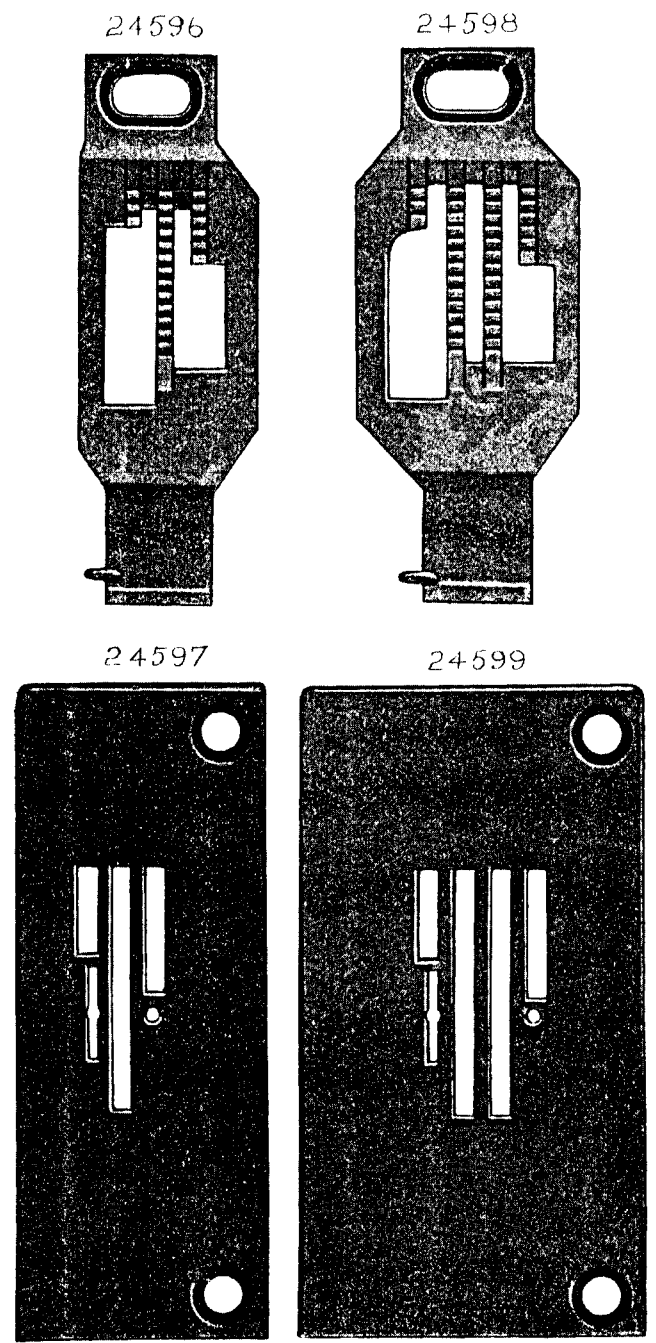
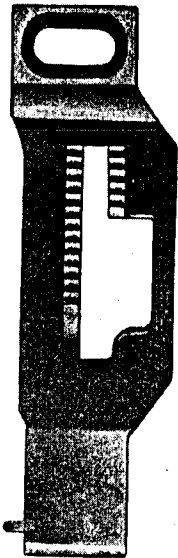
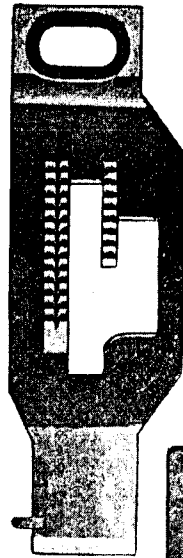


PLATE 2586—FULL SIZE

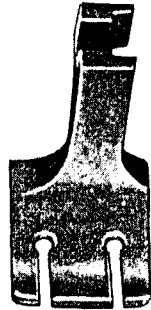
24592



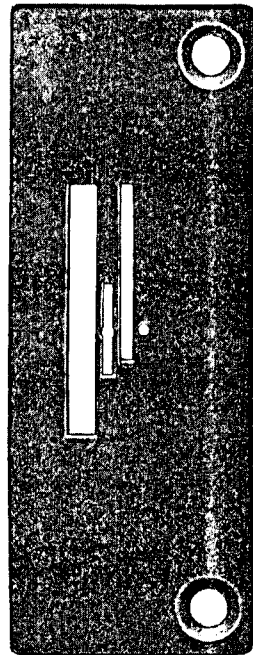
24594



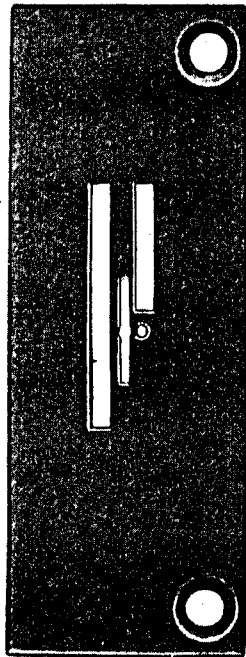
24600



24595



24593



62693

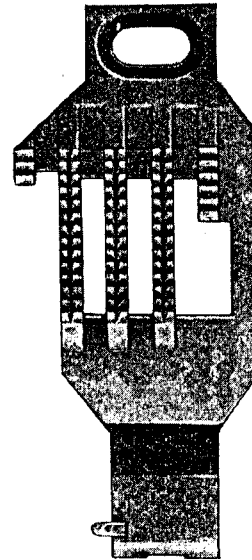


26276

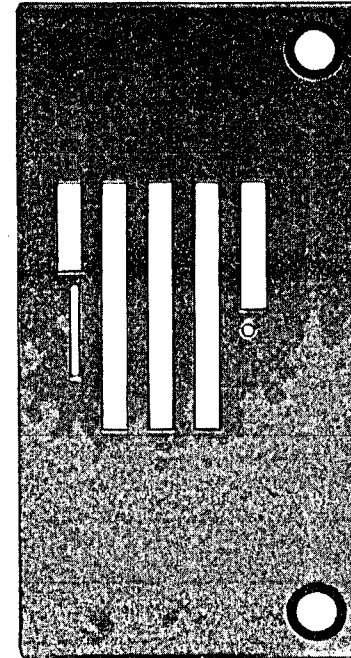


PLATE 2588—FULL SIZE

24735



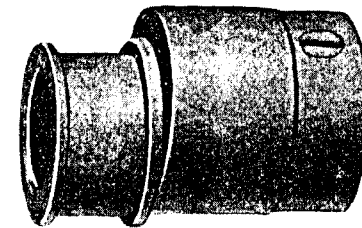
24736



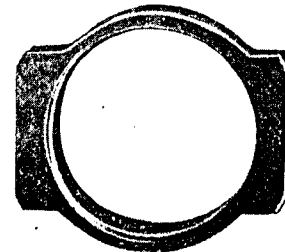
120225



24035



24036



12404

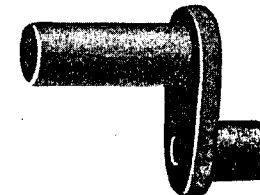
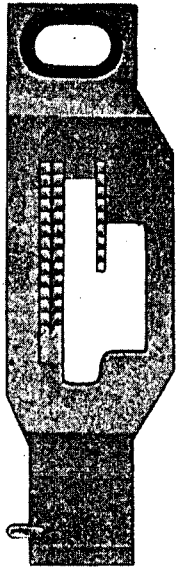
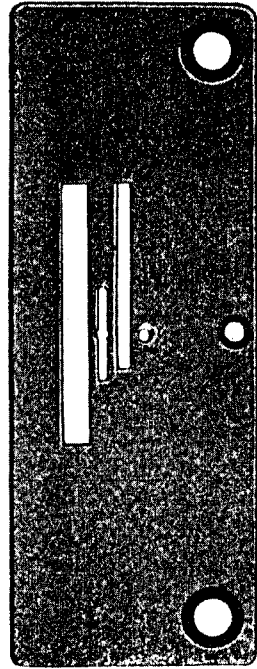


PLATE 2589—FULL SIZE

24594



62689



62688



19215



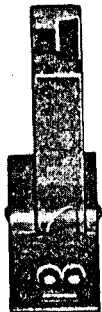
207 7071



62690



62695



62687

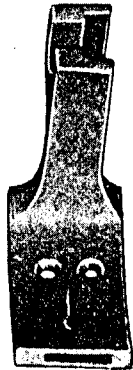
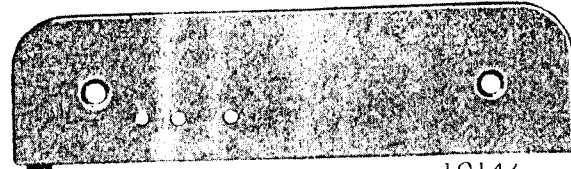
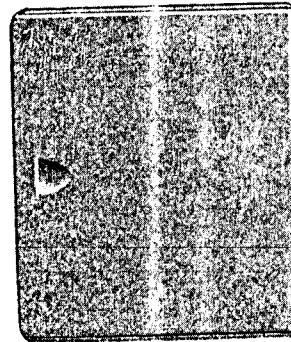


PLATE 2590—ONE-HALF SIZE

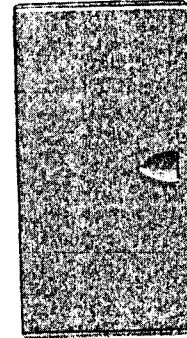
19185



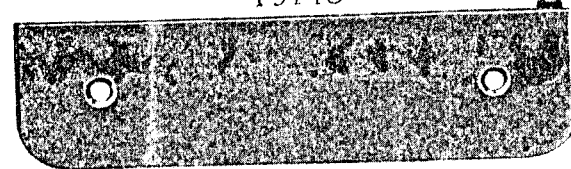
19145



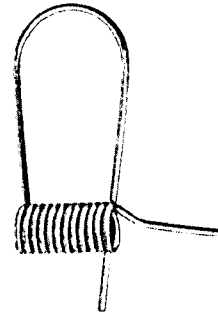
19146



19148



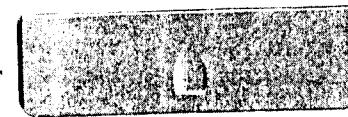
4883



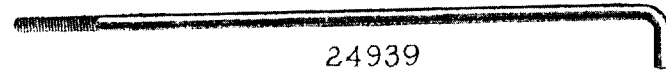
19281



19385



24940



24939

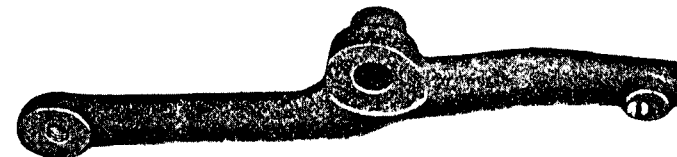


PLATE 2591—FULL SIZE

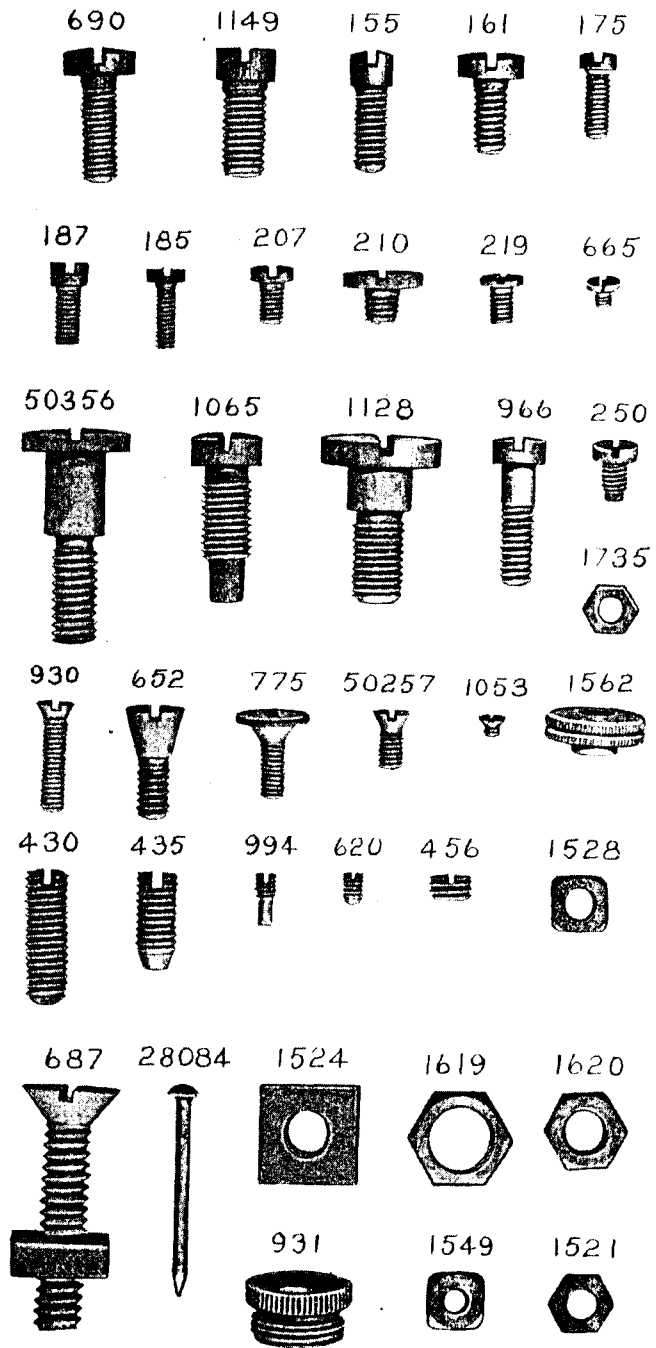


PLATE 2592—FULL SIZE

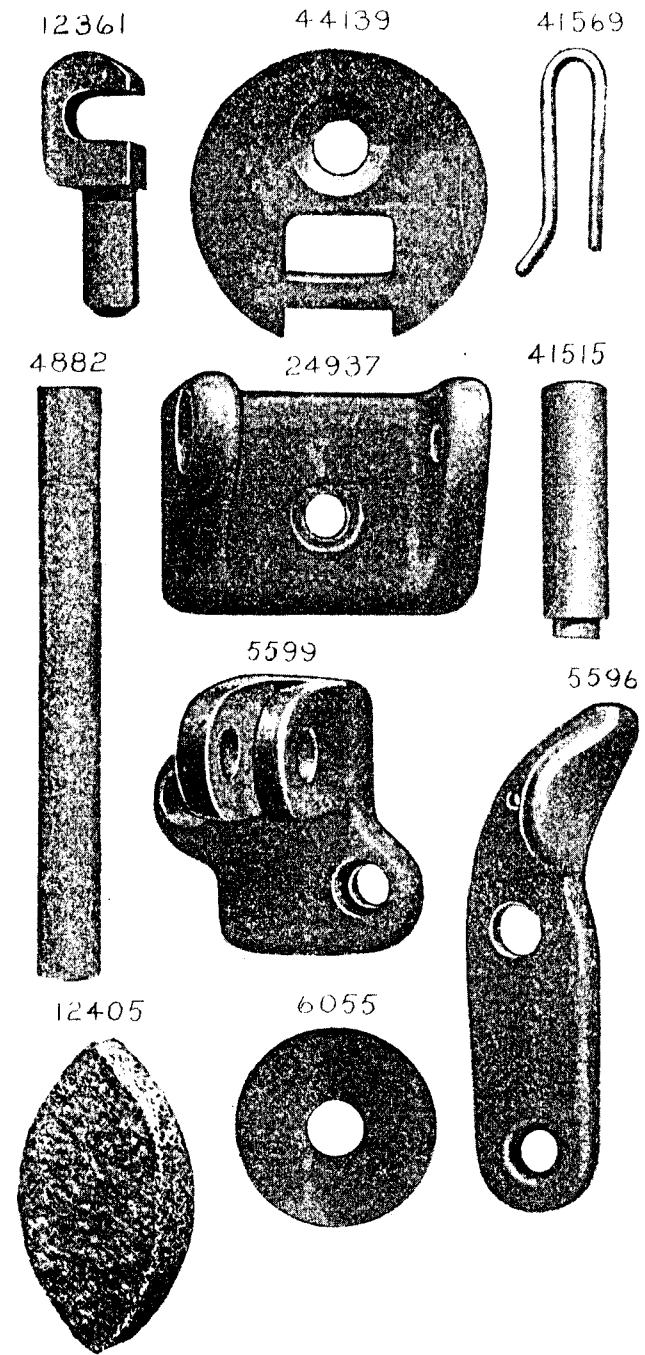


PLATE 2593—FULL SIZE

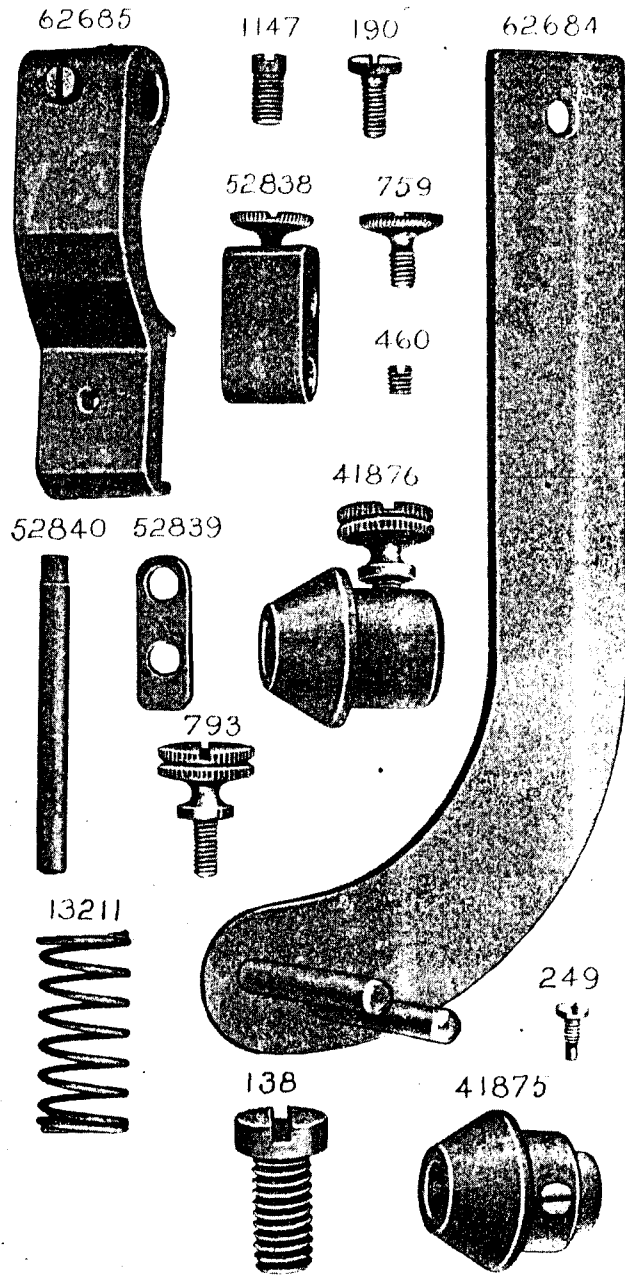


PLATE 2594—ONE-FOURTH SIZE

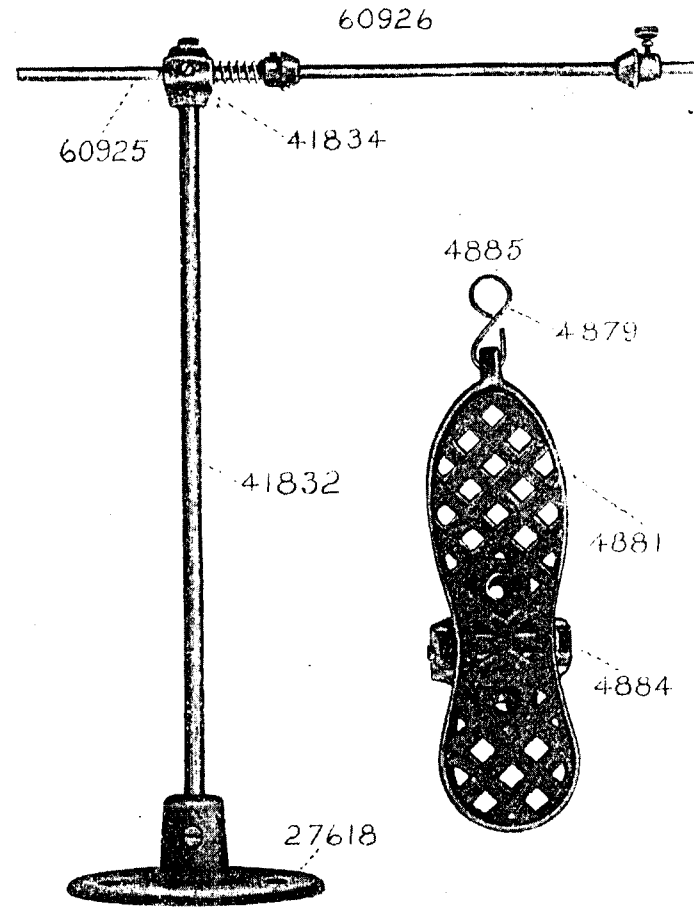


PLATE 3469—ONE-FOURTH SIZE

225436

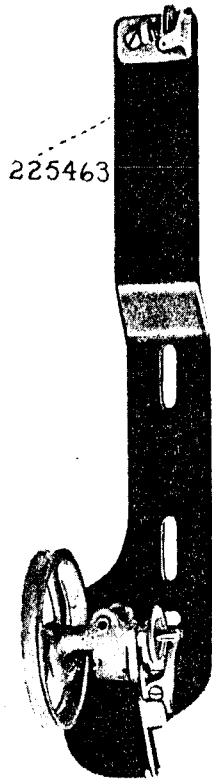
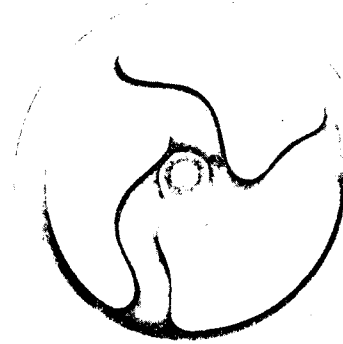


PLATE 3470—ONE-HALF SIZE

202473



225453

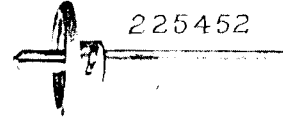


PLATE 3471—FULL SIZE

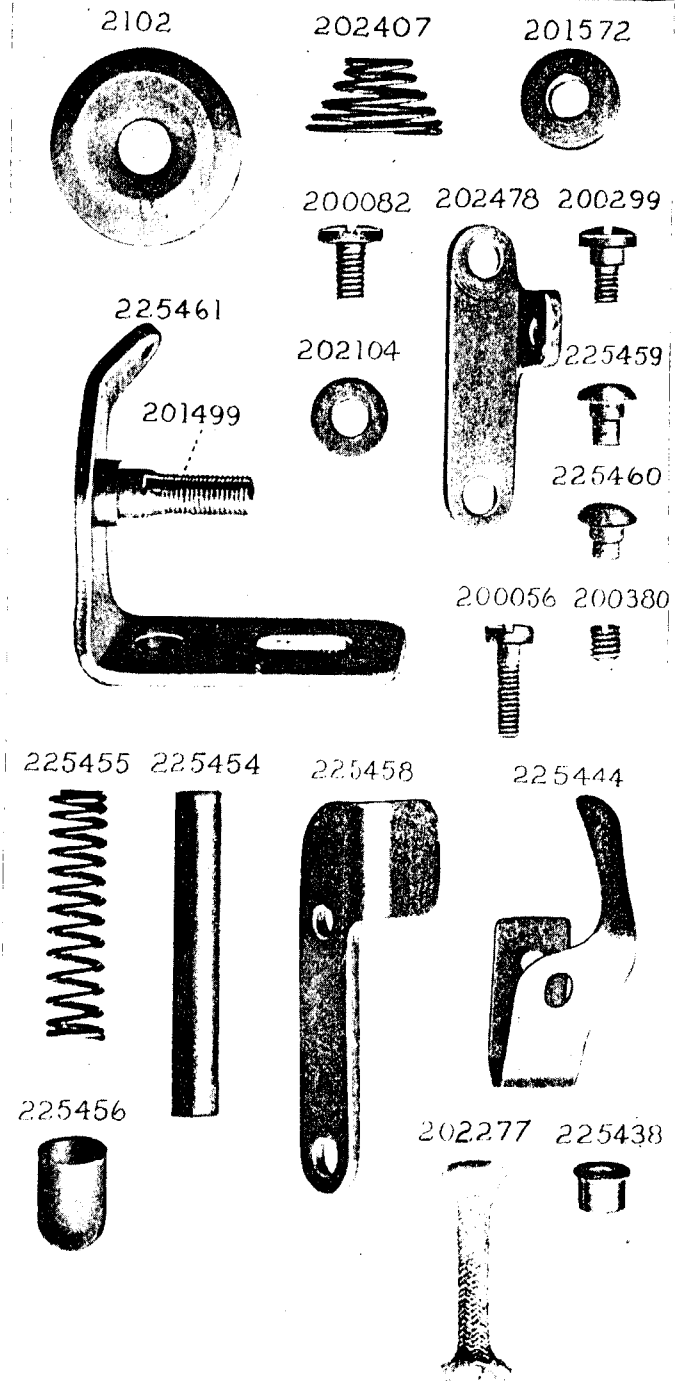


PLATE 5571—ONE-FOURTH SIZE

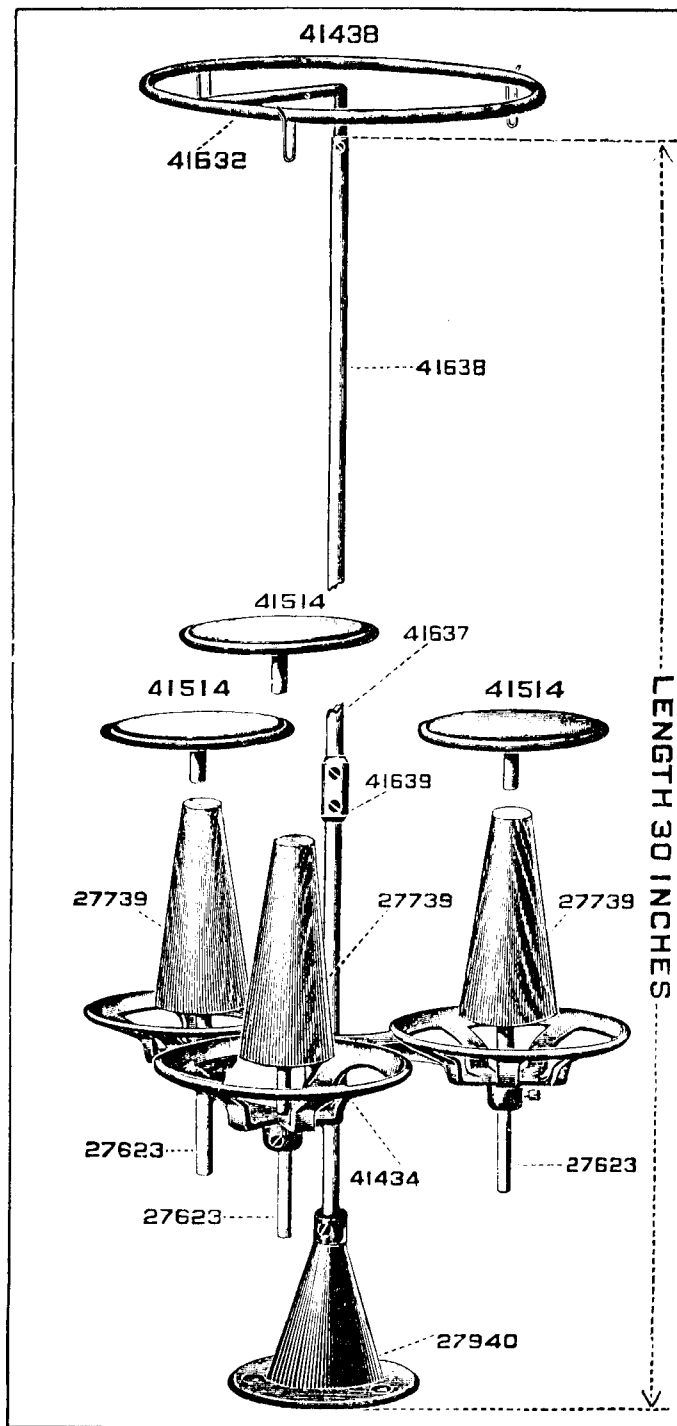


PLATE 5877—ONE-FOURTH SIZE

