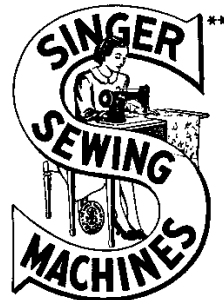


Singer 31-55

Form 18964
(236)
Printed in U. S. A.

HISTORICAL COPY
DO NOT REMOVE

LIST
OF
PARTS



SINGER**

MACHINE No. 31-55

THE SINGER MANUFACTURING COMPANY

**A Trade Mark of THE SINGER MANUFACTURING COMPANY

INSTRUCTIONS FOR OILING

To ensure easy running and prevent unnecessary wear of the parts which are in movable contact, the machine requires oiling and when in continuous use, "TYPE B" or "TYPE D" OIL, sold by Singer Sewing Machine Company, should be applied at least twice each day to all oil holes marked "OIL", as instructed in Form 7478.

"TYPE D" OIL should be used when an oil is desired which will produce a minimum of stain on fabrics, even after a long period of storage.

Copyright, U. S. A., 1936,
by The Singer Manufacturing Co.
All Rights Reserved for all Countries

INDEX

	Page
Accessories.....	15
Belt Guard.....	16
Bobbin Winders.....	16
Driving Attachment.....	19
Finger Guard.....	21
Foot Lifter Parts.....	24
Knee Lifter Parts.....	25
Machine Base.....	15
Machine No. 31-55.....	5
Numerical List of Parts.....	27
Spool Fixture (Wire).....	21
Spool Holder.....	21
Stay Guide.....	22
Tape Holders.....	22
Tape Spool Fixture (Wire).....	23
Thread Unwinder.....	26

INSTRUCTIONS FOR ORDERING

In ordering from this list, use **ONLY** the part **NUMBER** in the **FIRST** column.

The number stamped on a Sewing Machine Part is in every case the number of the single part only.

Every combination of parts sent out as such has its specific number, which, although not stamped on the parts, must be used when ordering the combination.

Each number always indicates the **SAME PART** in whatever list it appears, or for whatever machine.

The letters after some of the numbers indicate the style of finish only, as follows:

A-Hardened, Polished, Nickel Plated and Buffed

B-Polished, Nickel Plated and Buffed

C-Hardened Only

D-Polished Only

E-Soft, Not Polished

F-Hardened and Polished

G-Bright Rumbled and Nickel Plated

H-Blued

J-Nickel Plated Only

K-Hardened and Nickel Plated

L-Brass Plated

M-Oxidized

N-Japanned, Dull

P-Japanned, Bright

R-Merlized

T-Copper Plated

T.A-Hardened, Polished, Copper and Nickel Plated and Buffed

T.B-Copper and Nickel Plated and Polished

T.J-Copper and Nickel Plated Only

T.K-Hardened, Copper and Nickel Plated

T.M-Copper Plated and Oxidized

T.L-Copper and Brass Plated

U-Zinc Plated

V-Silver Plated

W-Polished and Nickel Plated

Y-Black Nickel Plated Only

Z-Chromium Plated

Z.B-Polished, Nickel Plated, Buffed and Chromium Plated

Z.J-Nickel and Chromium Plated

These letters **MUST BE USED** when they appear in the list; and **AFTER** the number as in the list.

In this series:

1 to 1500, 50001 to 51500 and 140001 to 142000 are Screw Numbers

1501 to 1800 and 51501 to 51800 are Nut Numbers

1801 to 2000 and 51801 to 52000 are Roller Numbers

2001 to 50000 and 52001 to 140000 and 142001 to

190000 are Sewing Machine Parts, 190001 and upward

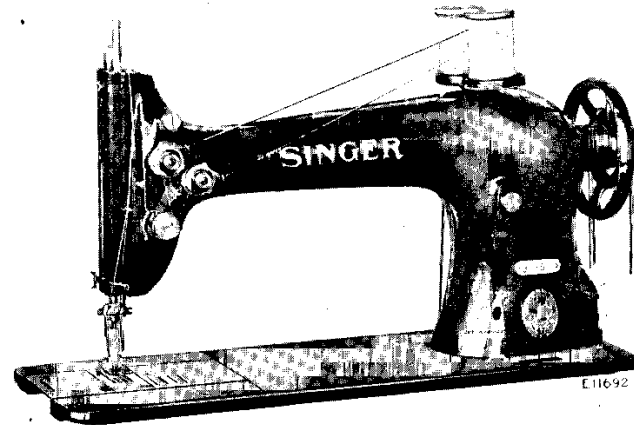
are numbers of Electrical Parts.

The figures in the second column refer only to the plates, illustrating the parts, and are **NOT TO BE USED** in ordering.

Parts marked with an asterisk (*) are furnished only when repairs are made at factory.

LIST OF PARTS COMPLETE

FOR



MACHINE No. 31-55

FOR VAMPING AND STAYING SHOES. GAUGES FROM 1/32 TO 3/16 INCH FOR VAMPING AND FROM 3/32 TO 1/4 INCH FOR STAYING. THROAT PLATE FLUSH WITH BED. DROP FEED. SPEED 1800 R.P.M.

No.	Plate	Name
*20013	----	Arm with 11104, 15404 and two 15405.....
8582	8645	" Dowel Pin.....
12453	8645	" Oil Tube for intermediate bearing...
15783	----	" " Tube.....
11119	8645	" " " 15783 with 52045, for oiling 19156.....
12454	8645	Arm Oil Tube with 132590, for oiling 12409.....
24131	8645	Arm Oil Tube with 52045, for oiling 12197
52045	8645	" " " Packing (wick).....
132590	8645	" " " (wick).....
748E	8645	" Screw (back).....
854E	8645	" " (front).....
12427	22302	" Shaft.....
*11104	----	" " Bushing (front).....
12357	8696	" " Flanged Bushing (back).....

No.	Plate	Name
448C	8645	Arm Shaft Flanged Bushing (back) Set Screw.....
144D	8645	Arm Shaft Screw.....
12480	8696	" Side Cap.....
219D	8692	" " Screw.....
12193	8696	" " Cover.....
51224D	8645	" " Thumb Screw.....
2415	8696	" Spool Bracket.....
15063	8696	" " " 2415 with two 12403...
145D	8645	" " " Screw.....
12403	8696	" " " Spool Pin and Thread Eyelet.....
11241	8696	Arm Spool Bracket Spool Pin Washer (cloth).....
12358	22302	Balance Wheel (power) light rim, 2 3/16 in. pulley, with two 448C.....
4370	22302	Balance Wheel (stand) heavy rim, 2 3/4 in. pulley, with two 448C.....
448C	8645	Balance Wheel Set Screw.....
*20026	-----	Bed.....
20197	8697	Crank Connecting Rod with two 896C.....
896C	8645	" " " Cap Screw.....
908C	8645	" " " Hinge Screw.....
1619E	8645	" " " " " Nut....
19304	-----	Face Plate.....
19305	8696	Face Plate complete, Nos. 19155, 19304 and 19327.....
190D	8690	Face Plate Screw.....
19327	8672	" " Thread Guard (lower) with 12152.....
12152	8672	Face Plate Thread Guard (lower) Rivet...
62624	8672	" " " " (upper).....
19155	-----	" " " " " 62624 with 12152.....
12152	8672	Face Plate Thread Guard (upper) Rivet...
51224D	8645	" " Thumb Screw.....
19111	8696	Feed Bar.....
313C	8672	" " Screw Center.....
1519E	8672	" " " " Nut.....
12197	8697	" Cam and Feed Lifting Eccentric with 446C.....
446C	8672	Feed Cam and Feed Lifting Eccentric Set Screw.....
3033	8672	Feed Connecting Link.....
375C	8689	" " " Hinge Screw.....
1518E	8689	" " " " Nut....
62505	8692	" Dog, 8 teeth (12 teeth to the inch) with 19118, for 1/32 in. to 3/16 in. gauge, for vamping, for 20128..

No.	Plate	Name
19306	8692	Feed Dog, 10 teeth (16 teeth to the inch) with 19118, for 1/32 in. to 3/16 in. gauge, for vamping, for 20128..
20205	8694	Feed Dog, 16 teeth (16 teeth to the inch) with 19118, for 3/32 in. to 1/4 in. gauge, for shoe staying, for 20206.
20166	8694	Feed Dog, 16 teeth (16 teeth to the inch) with 19118, for 3/32 in. to 3/16 in. gauge, for 20167.....
20203	8693	Feed Dog, 14 teeth (16 teeth to the inch) with 19118, for 3/32 in. to 3/16 in. gauge, for vamping, for 20204..
43966	8693	Feed Dog, 15 teeth (16 teeth to the inch) with 19118, for 5/32 in. to 1/4 in. gauge, for 43967.....
231C	8692	Feed Dog Screw.....
19116	8672	" " Spring.....
19117	8672	" " " Hook for 19120.....
19118	8672	" " " " " Feed Dogs.....
12123	8697	" Forked Connection.....
375C	8689	" " " " Hinge Screw.....
1518E	8689	" " " " " Nut..
12374	22302	" Lifting Rock Shaft.....
20017	-----	Feed Lifting Rock Shaft complete, Nos. 12374, 16556 and 19120.....
16556	8697	Feed Lifting Rock Shaft Crank (back) with 462C.....
2049	8689	Feed Lifting Rock Shaft Crank (back) Pin
462C	8672	" " " " " Set Screw.....
19120	8697	Feed Lifting Rock Shaft Crank (front) with 157E, 19117, 19121 and 19122...
157E	8672	Feed Lifting Rock Shaft Crank (front) Clamping Screw.....
19121	8672	Feed Lifting Rock Shaft Crank (front) Roller.....
19122	8672	Feed Lifting Rock Shaft Crank (front) Roller Pin.....
43976	8697	Feed Lifting Rock Shaft Crank Connecting Rod (cast iron) with two 966E.....
966E	8672	Feed Lifting Rock Shaft Crank Connecting Rod Cap Screw.....
375C	8689	Feed Lifting Rock Shaft Crank Connecting Rod Hinge Screw.....
1518E	8689	Feed Lifting Rock Shaft Crank Connecting Rod Hinge Screw Nut.....
307C	8672	Feed Lifting Rock Shaft Screw Center...
1513E	8672	" " " " " " Nut.
3039	8697	" Regulator.....

No.	Plate	Name
1128E	8672	Feed Regulator Hinge Screw.....
818D	8672	" " Thumb Screw.....
12379	22302	" Rock Shaft.....
20333	-----	Feed Rock Shaft complete, Nos. 12379 and 29633.....
29633	8697	Feed Rock Shaft Crank with 157J.....
157J	8672	" " " " Clamping Screw....
307C	8672	" " " " Screw Center.....
1513E	8672	" " " " Nut.....
18014	8698	Needle Bar (hollow).....
*12382	1144	" " Connecting Link with 794E....
794E	1144	" " " " Adjusting Screw.....
*12383	-----	Needle Bar Connecting Stud.....
12384	1144	Needle Bar Connecting Stud complete, Nos. 453C, 1904 and 12383.....
1904	1144	Needle Bar Connecting Stud Roller (roller only).....
453C	8689	Needle Bar Connecting Stud Set Screw....
20188	8697	" " Crank with 858C and 1065C....
1065C	8689	" " " " Position Screw.....
858C	8689	" " " " Set Screw.....
936E	8689	" " Screw Bushing.....
19124	8691	" Clamp with two 460F, for 1/32 in. to 5/64 in. gauge.....
19308	8691	Needle Clamp with two 209F and 460F, for 3/32 in. gauge and above.....
2273	8691	Needle Clamp Pin.....
460F	8691	" Set Screw for 19124.....
460F	8691	" " " (left) for 19308.....
209F	8691	" " " (right) for 19308.....
*24020	8697	Oil Cup.....
24021	8697	" " Extension.....
12486	8699	" " Packing (felt).....
24022	8697	Oil Cup complete, Nos. 12486, 24020 and 24021.....
44231	-----	Oil Cup 24022 with 44224.....
213F	8689	" " Screw.....
44224	8697	" " Thread Retainer.....
*19386	8698	Oscillating Rock Shaft.....
19387	-----	Oscillating Rock Shaft complete, Nos. 4784, 12388 and 19386.....
12388	8698	Oscillating Rock Shaft Hinge Pin.....
878D	8689	" " " " Oil Hole Stop Screw.....
12459	8689	Oscillating Rock Shaft Hinge Pin Oil Hole Stop Screw Washer (leather)...
448C	8645	Oscillating Rock Shaft Hinge Pin Set Screw.....

No.	Plate	Name
4784	8689	Oscillating Rock Shaft Oil Pad.....
20016	22302	" " Shaft.....
19496	-----	" " Crank.....
19388	8689	Oscillating Shaft Crank complete, Nos. 457C, 1518E, 19390 and 19496.....
2049	8689	Oscillating Shaft Crank Pin.....
457C	8689	" " " " Set Screw.....
19389	8689	" " " " Slide Block.....
226D	8689	" " " " " " Cap Screw.....
12424	8689	Oscillating Shaft Crank Slide Block Cap Screw Washer.....
969C	8689	Oscillating Shaft Crank Slide Block Screw Stud.....
1518E	8689	Oscillating Shaft Crank Slide Block Screw Stud Nut.....
19390	-----	Oscillating Shaft Crank Slide Block complete, Nos. 226D, 969C, 12424 and 19389.....
12391	8698	Presser Bar (hollow).....
12326	8689	" " Guide Bracket with 453C....
453C	8689	" " " " Set Screw....
52016	8698	" " Lifter.....
689C	8689	" " " " Screw.....
1520E	8689	" " " " Nut.....
12327	8671	" " Lifting and Releasing Lever Bracket.....
11167	8698	Presser Bar Spring (light) .051 wire....
Note: No. 11167 is sent with this machine unless another spring is specified on order.		
12139	8698	Presser Bar Spring (medium) .055 wire...
20023	8698	" " " (heavy) .063 wire...
11170	8689	" " " Washer.....
19333	8690	" Foot, for inside stays.....
19186	8690	" " (long toe) for inside stays
20051	8690	" " with keel, slotted for tape for staying.....
20376	8690	Presser Foot, for shoe tips.....
26276	8690	" " Hinge Pin.....
20199	-----	" " Plate.....
26275	-----	" " Shank.....
20200	8690	Presser Foot (hinged) complete, for inside stays, Nos. 20199, 26275 and 26276.....
26276	8690	Presser Foot Hinge Pin.....
20287	-----	" " Plate.....
26275	-----	" " Shank.....
20288	8690	Presser Foot (hinged) complete, with keel slotted for tape, for staying, Nos. 20287, 26275 and 26276.....

No.	Plate	Name
28278	8690	Presser Foot Hinge Pin.....
43970	-----	" " Plate.....
43971	-----	" " Shank.....
43972	8690	Presser Foot (hinged) long toe, complete for inside stays, Nos. 28278, 43970 and 43971.....
190D	8690	Presser Foot Screw.....
19478	8690	" " (spring presser).....
19477	8690	" " " " Bracket with 465C.....
465C	8690	Presser Foot (spring presser) Bracket Set Screw.....
4460	8690	Presser Foot (spring presser) Guide with 735C.....
735C	8690	Presser Foot (spring presser) Guide Set Screw.....
4461	8690	Presser Foot (spring presser) Spring....
4462	8690	" " " " Screw Bushing.....
1607D	8690	Presser Foot (spring presser) Stop Nut..
19478	8690	Presser Foot (spring presser) complete, Nos. 1607D, 4460 to 4462, 19478 and 19477.....
888E	8698	Pressure Regulating Thumb Screw.....
1903	1210	Roller, 1 1/4 in. diam., with 652D and 1528D, for 19211 and 19212.....
1875	1210	Roller, 1 1/2 in. diam., with 634D and 1528D, for 19213 and 19214.....
19196	5771	Roller Arm for 19211.....
19197	5771	" " " 19212.....
19198	5771	" " " 19213.....
19199	5771	" " " 19214.....
440F	8691	" " Adjusting Screw.....
1547D	1146	" " " " Nut.....
19200	5771	" " Bracket for 19212 and 19214..
17567	5771	" " " " 19211.....
4777	5771	" " " " 19213.....
316F	8691	" " " " Screw Center.....
1547J	1146	" " " " Nut.....
7556	1210	" " Lock Spring.....
176D	8691	" " " " Screw.....
1549J	8691	" " " " Nut.....
19201	1210	" Needle Guard (flat) 1/32 in. to 1/16 in. gauge, for 19211.....
19204	1210	Roller Needle Guard (flat) 1/32 in. to 1/16 in. gauge, for 19213.....
207F	8691	Roller Needle Guard (flat) Screw.....
19207	1210	" " " " (round) 1/32 in. to 1/16 in. gauge, for 19211.....

No.	Plate	Name
19208	1210	Roller Needle Guard (round) 3/32 in. to 1/4 in. gauge, for 19212 and 19214.
19209	1210	Roller Needle Guard (round) 1/32 in. to 1/16 in. gauge, for 19213.....
171F	8691	Roller Needle Guard (round) Set Screw...
19211	1209	Roller Presser complete, 1 1/4 in. roll- er, for 1/32 in. to 1/16 in. gauge, Nos. 171F, 176D, 207F, 440F, 1549J, 1903, 7556, 17567, 19196, 19201, 19207, two 316F and three 1547J.....
19212	1209	Roller Presser complete, 1 1/4 in. roll- er, for 3/32 in. to 1/4 in. gauge, Nos. 171F, 176D, 440F, 1549J, 1903, 7556, 19197, 19200, 19208, two 316F and three 1547J.....
19213	1209	Roller Presser complete, 1 1/2 in. roll- er, for 1/32 in. to 1/16 in. gauge, Nos. 171F, 176D, 207F, 440F, 1549J, 1875, 4777, 7556, 19198, 19204, 19209, two 316F and three 1547J.....
19214	1209	Roller Presser complete, 1 1/2 in. roll- er, for 3/32 in. to 1/4 in. gauge, Nos. 171F, 176D, 440F, 1549J, 1875, 7556, 19199, 19200, 19208, two 316F and three 1547J.....
190D	8690	Roller Presser Screw.....
652D	8691	" " Screw for 1903.....
634D	8691	" " " " 1875.....
1528D	8691	" " " " Nut.....
19131	8651	Shuttle (inside) Bobbin.....
62606	-----	" " " " Case.....
19310	8651	" " " " " Latch and Position Finger.....
2521	8691	Shuttle (inside) Bobbin Case Latch and Position Finger Spring.....
592E	8651	Shuttle (inside) Bobbin Case Latch and Position Finger Stop Screw.....
19312	8651	Shuttle (inside) Bobbin Case complete, Nos. 591F, 592E, 2521, 19149, 19310 and 62606.....
19136	8651	Shuttle (inside) Body.....
591F	8651	" " " Tension Regulating Screw
19149	8651	" " " Spring.....
19324	8651	" " " 1 11/16 in. diam., Nos. 19131, 19136 and 19312.....
19131	8651	Shuttle (outside) Bobbin.....
62608	-----	" " " " Case.....
19311	8651	" " " " " Latch and Position Finger.....

No.	Plate	Name
2521	8691	Shuttle (outside) Bobbin Case Latch and Position Finger Spring.....
592E	8651	Shuttle (outside) Bobbin Case Latch and Position Finger Stop Screw.....
19313	8651	Shuttle (outside) Bobbin Case complete, Nos. 591F, 592E, 2521, 19172, 19311 and 62608.....
19171	8650	Shuttle (outside) Body for 19326.....
19137	8650	" " " " 19325.....
591F	8651	" " Tension Regulating Screw.....
19172	8650	Shuttle (outside) Tension Spring.....
19326	8650	" " 1 11/16 in. diam., for 1/32 in. to 13/64 in. gauge, Nos. 19131, 19171 and 19313.....
19325	8650	Shuttle (outside) 1 11/16 in. diam., for 7/32 in. gauge and above, Nos. 19131, 19137 and 19313.....
19139	8698	Shuttle Driver with two 453C.....
2049	8689	" " Pin.....
453C	8689	" " Set Screw.....
19315	-----	" Race Body with 19316, for 19323.
19379	-----	" " " for 19382, 24013 and 24014.....
19316	1213	Shuttle Race Loop Separator for 19315...
19309	1213	" Needle Guard for 19323 and 24013.....
1053D	8691	Shuttle Race Needle Guard Screw.....
19317	1213	" Ring (inside) for 19323 and 24013.....
19380	1214	Shuttle Race Ring (inside) for 19382 and 24014.....
19318	1213	Shuttle Race Ring (outside) for 19323, 24013 and 24014.....
19381	1214	Shuttle Race Ring (outside) for 19382...
2532	8691	" " Position Pin.....
2533	1215	" " Spring.....
907D	8650	" " Screw.....
19382	1214	Shuttle Race complete, for 1/32 in. to 5/64 in. gauge, Nos. 19379 to 19381, two each 907D, 2533 and four 2532...
19323	1213	Shuttle Race complete, for 3/32 in. to 5/32 in. gauge, Nos. 19309, 19315, 19317, 19318, two each 907D, 1053D, 2533 and four 2532.....
24013	1215	Shuttle Race complete, for 11/84 in. gauge and above, Nos. 19309, 19317, 19318, 19379, two each 907D, 1053D, 2533 and four 2532.....

No.	Plate	Name
24014	1215	Shuttle Race complete, for 3/32 in. to 3/16 in. gauge, for vamping, Nos. 19318, 19379, 19380, two each 907D, 2533 and four 2532.....
145F	8645	Shuttle Race Screw.....
19319	8698	" " Slide (inside).....
19320	8691	" " " " Stop Stud....
19321	8691	" " " " " " " " Spring.....
19322	8698	Shuttle Race Slide (outside) with 662D and 19147.....
19147	8650	Shuttle Race Slide (outside) Friction Spring.....
662D	8691	Shuttle Race Slide (outside) Friction Spring Screw.....
2921	1146	Tension Disc.....
19191	1146	" Plate, for upper tension, with 19231.....
134D	8650	Tension Plate Screw.....
1560C	1146	" Regulating Thumb Nut.....
19192	1146	" Releaser.....
43944	8698	" Releasing Lever.....
12398	8650	" " Hinge Pin.....
12329	8650	" " Spring.....
19193	1146	" " (intermediate)..
19231	1146	" " " Hinge Block.....
2269	1146	Tension Releasing Lever (intermediate) Hinge Pin.....
19194	1146	Tension Releasing Lever (intermediate) Spring.....
916C	1146	Tension Screw Stud.....
44209	-----	" " " 916C with 1560C.....
1547D	1146	" " Nut.....
2923	1146	" Spring.....
19195	1146	Tension (upper) complete with Tension Release, Nos. 2269, 19191, 19193, 19194, two each 1547D, 2923, 19192, 44209 and four 2921.....
12149	8671	Thread Guard for 19162.....
19159	8671	" Guide Body.....
19161	8671	" Cap.....
19180	8671	" Roller.....
905D	8671	" Screw.....
19162	-----	Thread Guide complete (roller) Nos. 905D and 19159 to 19161.....
24129	1144	Thread Take-up Crank.....
3094	1144	" " Wedge.....
690E	1144	" " " Screw.....

No.	Plate	Name
19156	1144	Thread Take-up Lever.....
775E	1144	" " " Cap Screw.....
12166	1144	" " " Hinge Pin.....
12409	1144	" " " Link.....
11204	1144	" " " Hinge Pin....
435C	8671	" " " " " Set Screw.....
19157	1144	Thread Take-up Lever complete, Nos. 12166, 12409 and 19156.....
19158	8671	Thread Take-up Spring (music wire)....
7336	8671	" " " Regulator.....
448C	8645	" " " " " Set Screw
20126	-----	Throat Plate Body for 20128.....
20127	8692	" " " Loop Separator for 20128..
219D	8692	" " " " " Screw.....
20128	8692	Throat Plate complete for 19306 and 62505, Nos. 219D, 20126 and 20127..
20206	8694	Throat Plate for 20205.....
20167	8694	" " " 20166.....
20204	8693	" " " 20203.....
43967	8693	" " " 43966.....
691F	8650	" " " Screw.....
*15404	-----	Trade Mark.....
15405	-----	" " Rivet.....
44212	8678	Drip Pan with four 1 in. wire nails....

**SINGER Needles should be used
in SINGER Machines**
 These Needles and their Containers
 are marked with the
 Company's Trade Mark "SIMANCO.**" ¹

Needles in Containers marked
"FOR SINGER MACHINES"
 are NOT SINGER made needles. ²

MACHINE BASE

No.	Plate	Name
19219	8675	Bed Frame Cushion (leather).....
158C	8675	" " " " " Screw.....
19220	8675	" " " " " Spring.....
19226	8675	" " " " " Hinge Connection.....
19398	-----	" " " " " " 19226 with 211E and 19397.....
19397	8675	Bed Frame Hinge Connection Cap.....
211E	8675	" " " " " " " Screw....
16555	8675	" " " " " Plate.....
14010	8675	" " " " " Rivet.....
20067	819	" " " with two each 16555, 19398, four each 19219, 19220, six each 14010, wood screws 1 1/4 in. No. 12 and eight 158C.....

ACCESSORIES

No.	Plate	Name
51075E	8675	Machine Hinge Bolt with 51581E.....
51581E	-----	" " " " " Nut.....
6055	8675	" " " " " Washer.....
44180	-----	Machine Hinge complete, Nos. 6055, 12361 44139 and 51075E.....
12361	8675	Machine Hinge Connection.....
44139	8675	" " " Plate.....
44140	-----	Machine Hinge complete, Nos. 12361, 44139 and merlized wood screw 1 1/4 in. No. 14.....
12405	8675	Machine Rest (felt).....
41400	8680	" " " Pin (wood).....
120346	8680	Oiler (copper plated) with 120347.....
120347	8680	" Spout, 8 1/2 in. long.....
26026	8680	Screw Driver (large).....
26485	8680	" " " (small).....
120341	8680	Tweezers (curved).....
8908	8680	Wrench for 1520.....
8909	8680	" " " 1513 and 1518.....
19221	8680	" " " 936 and 1619.....

BELT GUARD

No.	Plate	Name
41929	22302	Belt Guard.....
8418	8686	" " Button.....
8419	8695	" " " Washer (leather).....
8420	-----	" " " 8418 with 8419 and wood screws 1 1/4 in. No. 9 R.H.B..
41930	8686	Belt Guard Hinge.....
41931	-----	Belt Guard complete, Nos. 8420, 41929, two 41930 and four wood screws 3/4 in. No. 9.....

BOBBIN WINDERS

BOBBIN WINDER

FOR 4370

No.	Plate	Name
15072	8695	Bobbin Position Pin.....
12168	8685	Bracket.....
692D	8695	" Screw for 12172.....
12169	8685	Frame.....
12171	8685	Frame complete, Nos. 333D, 5960, 5961, 5963, 12169 and 15077.....
32D	8695	Frame Hinge Screw.....
5960	8685	Friction Wheel (leather).....
5961	8685	" " Washer.....
333D	8695	" " " Screw.....
15077	8685	Spindle with 15072.....
5963	8685	" Flange.....
12170	8685	Spring.....
180F	8695	" Screw.....
12172	-----	Bobbin Winder complete, Nos. 32D, 180F, 12168, 12170 and 12171.....

BOBBIN WINDER

FOR 12358

NOTE: THIS BOBBIN WINDER IS THE SAME AS NO. 12172
WITH THE FOLLOWING EXCEPTIONS:

No.	Plate	Name
20307	8685	Frame, in place of 12169.....
20308	8685	Frame complete, Nos. 333D, 5960, 5961, 5963, 15077 and 20307, in place of 12171.
20309	-----	Bobbin Winder complete, Nos. 32D, 180F, 12168, 12170 and 20308.....

BOBBIN WINDER

(SWINGING AUTOMATIC, RIGHT HAND)

FOR 19131

FOR POWER TABLE

No.	Plate	Name
225433	8678	Bobbin Winder and Tension Bracket Base..
225453	8686	Frame with 202277 and 225438.....
225454	8686	" Hinge Pin.....
202277	8676	" Oil Packing (wick).....
225438	8676	" " Well Cap.....
225455	8676	" Spring.....
225456	8676	" " Plunger.....
202473	8686	Pulley with 200380C.....
200380C	8676	" Set Screw.....
225381	8686	Spindle.....
225444	8686	Stop Latch.....
200056E	8676	" " Screw.....
225458	8686	" " Thumb Lever.....
225459	8676	" " " " Hinge Stud.....
225459	8676	" " " " Joint Stud.....
202478	8686	" " Trip Lever.....
200299H	8676	" " " " Hinge Screw.....
225461	8686	Tension Bracket with 201499B.....
200082D	8676	" " Screw.....
228026	8676	" " " Washer.....
2102	8676	" Disc.....
202407	8676	" Spring.....
201499B	8686	" Stud.....
201572B	8676	" " Thumb Nut.....
225462	-----	Tension Bracket complete, Nos. 201572B, 202407, 225461 and two 2102.....

No.	Plate	Name
225382	8678	Bobbin Winder complete, Nos. 200056E, 200082D, 200299H, 202473, 202478, 225381, 225433, 225444, 225453 to 225456, 225458, 225462, 228026, two each 225459 and wood screws 3/4 in. No. 12 R.H.B.....

BOBBIN WINDER

(SWINGING AUTOMATIC, RIGHT HAND)

FOR 19131

FOR STAND

No.	Plate	Name
27540	8699	Base.....
15072	8695	Bobbin Position Pin.....
27302	8699	Frame.....
50356D	8676	" Hinge Screw.....
1620J	8676	" " Nut.....
27303	8676	" Spring.....
27541	8699	Pulley.....
•27849	-----	Spindle.....
27538	8699	" 27849 with 15072, 27850 and 41828
•27850	-----	" Collar.....
41828	8695	" " Pin.....
27306	8686	Spool Pin.....
27307	8686	" Stand.....
27308	8686	Spool Stand complete, Nos. 418E, 1562J, 2106, 10141, 11241, 27306, 27307, two each 2455 and wood screws 1 in. No. 10.....
11241	8696	Spool Washer (cloth).....
27587	8686	Stop Latch.....
35D	8695	" Hinge Screw.....
2455	8695	Tension Disc.....
1562J	8695	" Regulating Thumb Nut.....
418E	8695	" Screw Stud.....
10141	8695	" Spring.....
2106	8695	" Thread Guide.....
27875	-----	Bobbin Winder, Nos. 35D, 1620J, 27302, 27303, 27538, 27540, 27541, 27587, 50356D and two wood screws 1 in. No. 7.....
27876	-----	Bobbin Winder (swinging automatic, right hand) complete, Nos. 27308 and 27875.....

DRIVING ATTACHMENT

No.	Plate	Name
16592	8687	Balance Wheel (friction) with 7958, 16524 and two 435C.....
16524	-----	Balance Wheel Friction Ring (leather)...
7958	8674	" " " " Stop Pin....
24355	8683	" " Oil Cover.....
210D	8674	" " " Screw.....
435C	8671	" " Set Screw.....
15072	8695	Bobbin Position Pin for 15077.....
16514	8685	" Winder Frame.....
32D	8695	" " Hinge Screw.....
16515	8685	Bobbin Winder Frame complete, Nos. 333D, 5960, 5961, 5963, 15077 and 16514.....
5960	8685	Bobbin Winder Friction Wheel (leather)...
5961	8685	" " " Washer....
333D	8695	" " " " Screw
15077	8685	" " Spindle with 15072.....
5963	8685	" " " Flange.....
27306	8686	" " Spool Pin.....
27307	8686	" " Stand.....
27308	8686	Bobbin Winder Spool Stand complete, Nos. 418E, 1562J, 2106, 10141, 11241, 27306, 27307, two each 2455 and wood screws 1 in. No. 10.....
11241	8696	Bobbin Winder Spool Washer (cloth).....
12170	8685	" " Spring.....
180F	8695	" " Screw.....
19258	8683	" " Stop Latch with 152F and 1550H.....
152F	8674	Bobbin Winder Stop Latch Adjusting Screw
1550H	8695	" " " " " "
		Nut.....
75D	8674	Bobbin Winder Stop Latch Hinge Screw....
27303	8676	" " " " Spring.....
2269	1146	" " " " Stop Pin.....
2455	8695	" " Tension Disc.....
1562J	8695	" " " Regulating Thumb Nut.....
418E	8655	Bobbin Winder Tension Screw Stud.....
10141	8695	" " " Spring.....
2106	8695	" " " Thread Guide.....
16530	8685	Bracket.....
692D	8695	" Screw.....
12458	8687	Drip Pan with four 1 in. wire nails, for 20141.....
16518	8687	Driving Arm with 2269, 2928 and two 15132

DRIVING ATTACHMENT

No.	Plate	Name
2928	8674	Driving Arm Brake (leather).....
15132	8674	" " Rivet.....
12178	8674	" " Friction Plug (wood).....
427E	8674	" " " " Adjusting Screw
1508C	8674	" " " " " " "
		Nut.....
693D	8683	Driving Arm Hinge Screw.....
1579C	8683	" " " " Nut.....
12475	8687	" " Pitman.....
20371	8683	" " " Crank.....
2022	8674	" " " Pin.....
20372	8683	" " " Spring.....
65D	8674	" " " Hinge Screw.....
19260	-----	Driving Arm complete, Nos. 32D,75D,180F, 427E,693D,1508C,1579C,12170,12178, 16515,16518,16530,19258 and 27303.
16594	8683	Driving Friction Pulley, 2 5/16 in.diam. with 861D and 10236.....
10236	8674	Driving Friction Pulley Center Bearing..
861D	8691	" " " Oil Hole Plug Screw.....
27072	-----	Shaft Driving Pulley (sectional,grooved) 12 in. diam., 1 3/16 in. bore, with two 597C, for 20141.....
597C	8674	Shaft Driving Pulley Clamping Screw....
12479	8683	Starting Crank.....
2022	8674	" " Pin.....
12477	8683	" " Shaft.....
*44176	-----	" " " 12477 with 12479, 20371 and two 2022.....
126036	8678	Treadle.....
126205	8683	" Bracket (left).....
126206	-----	Treadle Bracket (left) complete, Nos. 23258,126205,126207,126208 and two wood screws 1 in. No. 14.....
126207	8683	Treadle Bracket (left) Hook.....
23258	8674	" " " Friction Washer.....
126208	8674	Treadle Bracket (left) Hook Rivet.....
46681	8683	" " (right).....
60502	-----	" " " 46681 with two wood screws 1 in. No. 14.....
126209	-----	Treadle complete, Nos. 60502,126036 and 126206.....
27637	8687	Treadle Pitman Rod (lower).....
150208	8685	" " " Spring.....
8055	8675	" " " Washer
14081	8687	" " " (upper).....
80223	8687	" " " Clamp with 361C.....

DRIVING ATTACHMENT

No.	Plate	Name
		Treadle Pitman Rod Clamp Screw.....
361C	8674	" " Stop Collar with 362C.....
2762	8687	" " " Set Screw.....
362C	8674	" " " Set Screw.....
14233	8687	Treadle Pitman complete, Nos. 2762,6055, 14081,27637,80223 and 150208.....
126213	-----	Treadle and Pitman complete, Nos. 14233 and 126209.....
20141	-----	Driving Attachment with Bobbin Winder and Treadle complete, Nos. 210D, 692D,12475,16592,16594,19260,20372, 24355,27072,27308,44176,126213 and two 65D.....

FINGER GUARD

No.	Plate	Name
121349	8696	Finger Guard.....
120858	8696	" " Holder with 50302J.....
50302J	8691	" " " Set Screw.....
236J	8691	" " " Screw.....
121350	8696	Finger Guard complete,Nos. 120858,121349 and two 236J.....

SPOOL FIXTURE (Wire)

No.	Plate	Name
4715	8684	Spool Fixture (wire) with two 10145....
4717	8684	" " Flange.....
10145	8684	" " Thread Eyelet.....
4718	8684	" " Washer (felt).....
4716	8684	Spool Fixture complete, for two spools, Nos. 4715,two 4717 and three 4718..

SPOOL HOLDER

(DISC)

No.	Plate	Name
26763	8699	Bracket with 219F and 50053D.....
219F	8692	" Screw.....

SPOOL HOLDER

No.	Plate	Name
50053D	8695	Bracket Thumb Screw.....
19066	8699	Spindle.....
19067	8699	" " Thread Guiding Disc.....
691F	8650	" " " " Screw.....
28764	8699	Spool Holder complete, Nos. 691F,19066, 19067 and 28763.....

STAY GUIDE

No.	Plate	Name
26266	8699	Stay Guide Plate (lower).....
26267	8699	" " " (upper).....
193F	8691	" " Screw, for 26266.....
7071	8691	" " washer, for 26268.....
26268	-----	Stay Guide complete, Nos. 26266 and 26267

TAPE HOLDERS

TAPE HOLDER

(5 IN. DISC)

FOR UNDER THE BENCH

No.	Plate	Name
36795	2116	Tape Holder Body.....
36796	2116	" " Cover.....
55D	8695	" " Hinge Screw.....
28994	2116	Tape Holder complete, Nos. 55D,36795, 36796 and two wood screws 1 1/4 in. No. 10.....

TAPE HOLDER

(8 IN. DISC)

No.	Plate	Name
26061	989	Bracket Wire with Disc.....
26062	989	Disc (adjustable) with 35925 and 51224D.
35925	8695	" Hub.....
51224D	8645	" " Thumb Screw.....
26325	8699	Foot with 736J and three wood screws 1 in. No. 12.....

TAPE HOLDER

No.	Plate	Name
736J	8695	Foot Screw.....
28063	989	Tape Holder (straight) complete, for 26065, Nos. 26061 and 26062.....
26065	-----	Tape Holder with Foot complete, Nos. 26063 and 26325.....

TAPE HOLDER

(10 IN. DISC)

No.	Plate	Name
26066	989	Bracket Wire.....
26067	-----	Bracket Wire complete, Nos. 26066, 26068 and 26072.....
26068	989	Disc.....
26069	989	" Hub.....
26070	-----	" " Rivet for 26071.....
26071	-----	Disc complete, Nos. 26068 and 26069.....
26064	8699	Foot with 736J and three wood screws 1 in. No. 12.....
736J	8695	Foot Screw.....
26072	989	Tape Guide.....
26073	8695	Tension Adjusting Collar with 51224B....
51224B	8645	" " " Thumb Screw....
13211	8695	" " Spring.....
26074	989	Tape Holder (offset) complete, for 26343 Nos. 13211,26067,26071 and 26073...
26343	-----	Tape Holder with Foot complete, Nos. 26064 and 26074.....

TAPE SPOOL FIXTURE (Wire)

No.	Plate	Name
4516	8684	Tape Spool Fixture (wire) with fixed cone.....
4518	8684	Tape Spool Fixture Cone.....
1541B	8684	" " " Regulating Thumb Nut.
8019	8684	" " " Spring.....
4517	8684	Tape Spool Fixture (wire) with fixed cone complete, Nos. 1541B,4516,4518 and 8019.....

FOOT LIFTER PARTS

No.	Plate	Name
5596	22301	Bell Crank.....
56848	-----	" " 5596 with 5599 and 5601.....
5599	22301	" " Bracket.....
178E	8676	" " " Screw.....
5601	8676	" " Hinge Pin.....
5735	22301	" " Spring.....
5598	22301	Bell Crank complete, Nos. 5735 and 56848
5670	-----	Chain, length 26 in. to 35 in. with 56864 and 56865.....
Note: When ordering No. 5670 state length required		
4879	22301	Chain Connecting Link for 4885.....
56864	22301	" Hook (large).....
56865	22301	" " (small).....
12237	22301	Lifting Lever with 448C.....
12415	22301	" " Connecting Rod.....
12416	22301	" " " " Joint.....
76D	8676	" " " " " Hinge Screw.....
1521E	8676	Lifting Lever Connecting Rod Lock Nut...
802D	8676	" " Hinge Screw.....
12241	8671	" " Link.....
766D	8671	" " Hinge Screw.....
12240	22301	" " Pin.....
448C	8645	" " Set Screw.....
2763	8688	Rock Shaft.....
12242	819	" " Hanger with two wood screws 1 in. No. 10.....
6337	8688	Rock Shaft Lifting Bracket with two 356C
12243	819	" " " " Hook for 5598
7125	819	" " " " " 5670
356C	8671	" " " " " Set Screw
356C	8671	" " " " " Set Screw.....
2770	8688	" " Stop Dog with 356C.....
356C	8671	" " " " " Set Screw.....
4880	819	Rock Shaft complete, Nos. 2763, 2770, 7125, 12243 and two each 6337 and 12242..
4881	819	Treadle.....
4882	22301	" Shaft.....
4883	22301	" Spring.....
4884	819	" Stand.....
4885	819	Treadle complete, Nos. 4879, 4881 to 4884 and two wood screws 1 in. No. 16...
20008	-----	Foot Lifter complete, Nos. 76D, 766D, 802D, 1521E, 4880, 4885, 5598, 5670, 12237, 12240, 12241, 12415, 12416 and two 178E.....

KNEE LIFTER PARTS

No.	Plate	Name
5596	22301	Bell Crank.....
56848	-----	" " 5596 with 5599 and 5601.....
5599	22301	" " Bracket.....
178E	8676	" " " Screw.....
5601	8676	" " Hinge Pin.....
5735	22301	" " Spring.....
5598	22301	Bell Crank complete, Nos. 5735 and 56848
12237	22301	Lifting Lever with 448C.....
12415	22301	" " Connecting Rod.....
12416	22301	" " " " Joint.....
76D	8676	" " " " " Hinge Screw.....
1521E	8676	Lifting Lever Connecting Rod Lock Nut...
802D	8676	" " Hinge Screw.....
12241	8671	" " Link.....
766D	8671	" " Hinge Screw.....
12240	22301	" " Pin.....
448C	8645	" " Set Screw.....
2763	8688	Rock Shaft for 12250.....
20091	8688	" " " 20465.....
7539	8688	" " Hanger with two wood screws 1 in. No. 10, for 12250.....
2764	8688	Rock Shaft Hanger (back) with two wood screws 1 in. No. 10, for 20465.....
16128	8688	Rock Shaft Hanger (front) with two wood screws 1 in. No. 10, for 20465.....
2765	8688	Rock Shaft Knee Arm.....
2766	8688	" " " " Hub with 356C, for 2768.....
20462	8688	Rock Shaft Knee Arm Hub with 356C, for 20463.....
356C	8671	Rock Shaft Knee Arm Hub Set Screw.....
2768	-----	Rock Shaft Knee Arm complete for 12250, Nos. 2765 to 2767.....
20463	-----	Rock Shaft Knee Arm complete for 20465, Nos. 2765, 2767 and 20462.....
2767	8688	Rock Shaft Knee Plate with 356C.....
356C	8671	" " " " Set Screw.....
20464	8688	" " Lifting Arm with 356C, for 20465.....
356C	8671	Rock Shaft Lifting Arm Set Screw.....
6337	8688	" " " Bracket with two 356C for 12250.....
2778	8688	Rock Shaft Lifting Bracket Hook for 12250.....

No.	Plate	Name
356C	8671	Rock Shaft Lifting Bracket Hook Set Screw.....
356C	8671	Rock Shaft Lifting Bracket Set Screw...
2770	8688	" " Stop Dog with 356C.....
356C	8671	" " Set Screw.....
12250	8688	Rock Shaft complete for 12445, Nos.2763 2768,2778,6337 and two each 2770 and 7539.....
20465	8688	Rock Shaft complete for 20466, Nos.2764 16128,20091,20463,20464 and two 2770.....
12445	-----	Knee Lifter complete (power table or stand No. 25265) Nos. 76D,766D,802D 1521E,5598,12237,12240,12241,12250 12415,12416 and two 178E.....
20466	-----	Knee Lifter complete (stand No. 25255) Nos. 76D,766D,802D,1521E,5598, 12237,12240,12241,12415,12416, 20465 and two 178E.....

THREAD UNWINDER FOR THREE SPOOLS

No.	Plate	Name
225259	8755	Spool Rest (for one spool) with 201018C
225257	8755	" " (for two spools)with 201018C
150203	8755	" " Cushion (felt).....
225388	8755	" " Rod.....
200383C	8671	" " Set Screw.....
201018C	8671	" " Set Screw.....
202490	8755	" Stand with 200383C.....
225391	8755	Thread Guide.....
201696J	8671	" " Lock Nut.....
225326	8695	" " Position Cup.....
225324	8755	" " Rod with 208E and 225322..
208E	8671	" " Screw.....
225322	8671	" " Washer.....
259143	8755	Thread Unwinder complete, Nos. 201696J, 202490,225257,225259,225324,225326 225388, three each 150203,225391 and wood screws 7/8 in. No. 12....
27739	22301	Thread Cone (wood) for large cones.....
225390	22301	" Holder, for inverted cones.

Note: Nos. 27739 and 225390 are used with, but not included in 259143.

NUMERICAL LIST OF PARTS

No.	Plate	Name
32D	8695	Bobbin Winder Frame Hinge Screw for 12172, 19260 and 20309.....
35D	8695	Bobbin Winder Stop Latch Hinge Screw for 27875.....
55D	8695	Tape Holder Cover Hinge Screw for 28994.
65D	8674	Driving Arm Pitman Hinge Screw for 20141
75D	8674	Bobbin Winder Stop Latch Hinge Screw for 19260.....
76D	8676	Lifting Lever Connecting Rod Joing Hinge Screw for 12445,20008 and 20466....
134D	8650	Tension Plate Screw.....
144D	8645	Arm Shaft Screw.....
145D	8645	" Spool Bracket Screw.....
145F	8645	Shuttle Race Screw.....
152F	8674	Bobbin Winder Stop Latch Adjusting Screw for 19258.....
157E	8672	Feed Lifting Rock Shaft Crank (front) Clamping Screw for 19120.....
157J	8672	Feed Rock Shaft Crank Clamping Screw for 29633.....
158C	8675	Bed Frame Cushion Screw for 20067.....
171F	8691	Roller Needle Guard (round) Set Screw for 19211 to 19214.....
176D	8691	Roller Arm Lock Spring Screw for 19211 to 19214.....
178E	8676	Bell Crank Bracket Screw for 12445,20008 and 20466.....
180F	8695	Bobbin Winder Spring Screw for 12172, 19260 and 20309.....
190D	8690	Face Plate Screw.....
190D	8690	Presser Foot Screw.....
190D	8690	Roller Presser Screw.....
193F	8691	Stay Guide Screw for 26268.....
207F	8691	Roller Needle Guard (flat) Screw for 19211 and 19213.....
208E	8671	Thread Unwinder Thread Guide Rod Screw for 225324.....
209F	8691	Needle Set Screw (right) for 19308.....
210D	8674	Driving Attachment Balance Wheel O11 Cover Screw for 20141.....
211E	8675	Bed Frame Hinge Connection Cap Screw for 19398.....
213F	8689	O11 Cup Screw.....
219D	8692	Arm Side Cap Screw.....
219F	8692	Spool Holder Bracket Screw for 26763....

NUMERICAL LIST OF PARTS

No.	Plate	Name
766D	8671	Lifting Lever Link Hinge Screw for 12445, 20008 and 20466.....
775E	1144	Thread Take-up Lever Cap Screw.....
794E	1144	Needle Bar Connecting Link Adjusting Screw for 12382.....
802D	8676	Lifting Lever Hinge Screw for 12445, 20008 and 20466.....
818D	8672	Feed Regulator Thumb Screw.....
854E	8645	Arm Screw (front).....
858C	8689	Needle Bar Crank Set Screw for 20188...
861D	8691	Driving Friction Pulley Oil Hole Plug Screw for 16594.....
878D	8689	Oscillating Rock Shaft Hinge Pin Oil Hole Stop Screw.....
898C	8645	Crank Connecting Rod Cap Screw for 20197.....
905D	8671	Thread Guide Screw for 19162.....
907D	8650	Shuttle Race Ring Spring Screw for 19323, 19382, 24013 and 24014.....
908C	8645	Crank Connecting Rod Hinge Screw.....
916C	1146	Tension Screw Stud for 44209.....
936E	8689	Needle Bar Screw Bushing.....
966E	8672	Feed Lifting Rock Shaft Crank Connecting Rod Cap Screw for 43976.....
969C	8689	Oscillating Shaft Crank Slide Block Screw Stud for 19390.....
1053D	8691	Shuttle Race Needle Guard Screw for 19323 and 24013.....
1065C	8689	Needle Bar Crank Position Screw for 20198.....
1128E	8672	Feed Regulator Hinge Screw.....
1508C	8674	Driving Arm Friction Plug Adjusting Screw Nut for 19260.....
1513E	8672	Feed Lifting Rock Shaft Screw Center Nut.....
1513E	8672	Feed Rock Shaft Screw Center Nut.....
1519E	8689	" Connecting Link Hinge Screw Nut...
1519E	8689	" Forked Connection Hinge Screw Nut.
1519E	8689	" Lifting Rock Shaft Crank Connecting Rod Hinge Screw Nut.....
1518E	8689	Oscillating Shaft Crank Slide Block Screw Stud Nut for 19388.....
1519E	8672	Feed Bar Screw Center Nut.....
1520E	8689	Presser Bar Lifter Screw Nut.....
1521E	8676	Lifting Lever Connecting Rod Lock Nut for 12445, 20008 and 20466.....
1528D	8691	Roller Screw Nut for 1875 and 1903.....
1541B	8684	Tape Spool Fixture Regulating Thumb Nut for 4517

NUMERICAL LIST OF PARTS

No.	Plate	Name
1547D	1146	Roller Arm Adjusting Screw Nut.....
1547J	1146	" " Bracket Screw Center Nut for 19211 to 19214.....
1547D	1146	Tension Screw Stud Nut for 19195.....
1549J	8691	Roller Arm Lock Spring Screw Nut for 19211 to 19214.....
1550H	8695	Bobbin Winder Stop Latch Adjusting Screw Nut for 19258.....
1560C	1146	Tension Regulating Thumb Nut for 44209.
1562J	8695	Bobbin Winder Tension Regulating Thumb Nut for 27308.....
1579C	8683	Driving Arm Hinge Screw Nut for 19260..
1607D	8690	Presser Foot (spring presser) Stop Nut for 19478.....
1619E	8645	Crank Connecting Rod Hinge Screw Nut...
1620J	8676	Bobbin Winder Frame Hinge Screw Nut for 27975.....
1875	1210	Roller, 1 1/2 in. diam. with 634D and 1528D, for 19213 and 19214.....
1903	1210	Roller, 1 1/4 in. diam. with 652D and 1528D, for 19211 and 19212.....
1904	1144	Needle Bar Connecting Stud Roller (roller only) for 12384.....
2022	8674	Driving Arm Pitman Crank Pin for 44176.
2022	8674	" Attachment Starting Crank Pin for 44176.....
2049	8689	Feed Lifting Rock Shaft Crank (back) Pin.....
2049	8689	Oscillating Shaft Crank Pin.....
2049	8689	Shuttle Driver Pin.....
2102	8676	Bobbin Winder Tension Disc for 225462..
2106	8695	" " Thread Guide for 27308.....
2269	1146	Bobbin Winder Stop Latch Stop Pin for 16519.....
2269	1146	Tension Releasing Lever (intermediate) Hinge Pin for 19195.....
2273	8691	Needle Clamp Pin.....
2415	8696	Arm Spool Bracket for 15063.....
2455	8695	Bobbin Winder Tension Disc for 27308...
2521	8691	Shuttle (inside) Bobbin Case Latch and Position Finger Spring for 19312..
2521	8691	Shuttle (outside) Bobbin Case Latch and Position Finger Spring for 19313..
2532	8691	Shuttle Race Ring Position Pin for 19323, 19382, 24013 and 24014.....
2533	1215	Shuttle Race Ring Spring for 19323, 19382, 24013 and 24014.....

No.	Plate	Name
2762	8687	Driving Attachment Treadle Stop Collar with 3620, for 14233.....
2763	8688	Rock Shaft for 4880 and 12250.....
2764	8688	" " Hanger (back) and two wood screws 1 in. No. 10, for 20485....
2765	8688	Rock Shaft Knee Arm for 2768 and 20463.
2766	8688	" " " " Hub with 356C, for 2768.....
2767	9688	Rock Shaft Knee Plate with 356C, for 2768 and 20463.....
2768	-----	Rock Shaft Knee Arm complete, for 12250 Nos. 2765 to 2767.....
2770	8688	Rock Shaft Stop Dog with 356C, for 4880 12250 and 20485.....
2778	8688	Rock Shaft Lifting Bracket Hook for 12250.....
2921	1146	Tension Disc for 19195.....
2923	1146	" Spring for 19195.....
2928	8674	Driving Arm Brake (leather) for 16518..
3033	8672	Feed Connecting Link.....
3039	8697	" Regulator.....
3094	1144	Thread Take-up Crank Wedge.....
4370	22302	Balance Wheel (stand) heavy rim, 2 3/4 in. pulley with two 448C.....
4460	8690	Presser Foot (spring presser) Guide with 735C, for 19478.....
4461	8690	Presser Foot (spring presser) Spring for 19478.....
4462	8690	Presser Foot (spring presser) Spring Screw Bushing for 19478.....
4516	8684	Tape Spool Fixture (wire) with fixed cone, for 4517.....
4517	8684	Tape Spool Fixture (wire) with fixed cone complete, Nos. 1541B, 4516, 4518 and 3019.....
4518	8684	Tape Spool Fixture Cone for 4517.....
4715	8684	Spool Fixture (wire) with two 10145, for 4716.....
4716	8684	Spool Fixture complete, for two spools, Nos. 4715, two 4717 and three 4718.
4717	8684	Spool Fixture Flange for 4716.....
4718	8684	" " Washer (felt) for 4716....
4777	3771	Roller Arm Bracket for 19213.....
4784	8689	Oscillating Rock Shaft Oil Pad for 19387.....
4879	22301	Chain Connecting Link for 4885.....
4880	819	Rock Shaft complete for 20008, Nos. 2763 2770, 7125, 12243, two each 6337 and 12242.....

No.	Plate	Name
4881	819	Treadle for 4885.....
4882	22301	" Shaft for 4885.....
4883	22301	" Spring for 4885.....
4884	819	" Stand for 4885.....
4885	819	Treadle complete for 20008, Nos. 4879, 4881 to 4884 and two wood screws 1 in. No. 16.....
5596	22301	Bell Crank for 56848.....
5598	22301	Bell Crank complete for 12445, 20008 and 20466, Nos. 5735 and 56848.....
5599	22301	Bell Crank Bracket for 56848.....
5601	8676	" " Hinge Pin for 56848.....
5670	-----	Chain, length 26 in. to 35 in. with 56864 and 56865, for 20008.....
5735	22301	Bell Crank Spring for 5598.....
5960	8685	Bobbin Winder Friction Wheel (leather) for 12171, 16515 and 20308.....
5961	8685	Bobbin Winder Friction Wheel Washer for 12171, 16515 and 20308.....
5963	8685	Bobbin Winder Spindle Flange for 12171, 16515 and 20308.....
6055	8675	Driving Attachment Treadle Pitman Rod (lower) Spring Washer for 14233...
6055	8675	Machine Hinge Bolt Nut Washer for 44180 (Accessories).....
6337	8688	Rock Shaft Lifting Bracket with two 356C, for 4880 and 12250.....
7071	8691	Stay Guide Screw Washer for 26269.....
7125	819	Rock Shaft Lifting Bracket Hook for 4880 and 5670.....
7336	8671	Thread Take-up Spring Regulator.....
7539	8688	Rock Shaft Hanger with two wood screws 1 in. No. 10, for 12250.....
7556	1210	Roller Arm Lock Spring for 19211 to 19214.....
7958	8674	Driving Attachment Balance Wheel Friction Ring Stop Pin for 16592.....
8019	8684	Tape Spool Fixture Spring for 4517.....
8418	8686	Belt Guard Button for 8420.....
8419	8695	" " Washer (leather) for 8420.....
8420	-----	Belt Guard Button 8418 with 8419 and wood screws 1 1/4 in. No. 9 R.H.B. for 41931.....
8582	8645	Arm Dowel Pin.....
8903	8680	Wrench for 1520 (Accessories).....
8909	8680	" " 1513 and 1518 (Accessories).
10141	8695	Bobbin Winder Tension Spring for 27308.
10145	8684	Spool Fixture Thread Eyelet for 4715...

No.	Plate	Name
10236	8674	Driving Friction Pulley Center Bearing for 16594.....
*11104	-----	Arm Shaft Bushing (front) for 20013....
11119	8645	" Oil Tube 15783 with 52045, for oiling 19156.....
11167	8698	Presser Bar Spring (light) .051 wire...
11170	8689	" " " Washer.....
11204	1144	Thread Take-up Lever Link Hinge Pin....
11241	8696	Arm Spool Bracket Spool Pin Washer (cloth).....
11241	8696	Bobbin Winder Spool Washer (cloth) for 27308.....
12123	8697	Feed Forked Connection.....
12139	8698	Presser Bar Spring (medium) .055 wire..
12149	8671	Thread Guard for 19162.....
12152	8672	Face Plate Thread Guard (lower) Rivet for 19327.....
12152	8672	Face Plate Thread Guard (upper) Rivet for 19155.....
12166	1144	Thread Take-up Lever Hinge Pin for 19157.....
12168	8685	Bobbin Winder Bracket for 12172 and 20309.....
12169	8685	Bobbin Winder Frame for 12171.....
12170	8685	" " Spring for 12172, 19260 and 20309.....
12171	8685	Bobbin Winder Frame complete for 12172, Nos. 333D, 5960, 5961, 5963, 12169 and 15077.....
12172	-----	Bobbin Winder complete for 4370, Nos. 32D, 180F, 12168, 12170 and 12171....
12178	8674	Driving Arm Friction Plug (wood) for 19260.....
12193	8696	Arm Side Cover.....
12197	8697	Feed Cam and Feed Lifting Eccentric with 446C.....
12237	22301	Lifting Lever with 448C, for 12445, 20008 and 20466.....
12240	22301	Lifting Lever Pin for 12445, 20008 and 20466.....
12241	8671	Lifting Lever Link for 12445, 20008 and 20466.....
12242	819	Rock Shaft Hanger with two wood screws 1 in. No. 10, for 4880.....
12243	819	Rock Shaft Lifting Bracket Hook for 4880 and 5598.....
12250	8688	Rock Shaft complete for 12445, Nos. 2763 2768, 2778, 6337 and two each 2770 and 7539.....

No.	Plate	Name
12326	8689	Presser Bar Guide Bracket with 453C....
12327	8671	" " Lifting and Releasing Lever Bracket.....
12329	8650	Tension Releasing Lever Spring.....
12357	8696	Arm Shaft Flanged Bushing (back).....
12358	22302	Balance Wheel (power) light rim, 2 3/16 in. pulley, with two 448C.....
12361	8675	Machine Hinge Connection for 44140 and 44180 (Accessories).....
12374	22302	Feed Lifting Rock Shaft for 20017.....
12379	22302	" Rock Shaft for 20333.....
*12382	1144	Needle Bar Connecting Link with 794E...
*12383	-----	" " Stud for 12384...
12384	1144	Needle Bar Connecting Stud complete, Nos. 453C, 1904 and 12383.....
12388	8698	Oscillating Rock Shaft Hinge Pin for 19387.....
12391	8698	Presser Bar (hollow).....
12398	8650	Tension Releasing Lever Hinge Pin.....
12403	8696	Arm Spool Bracket Spool Pin and Thread Eyelet for 15063.....
12405	8675	Machine Rest (felt) Accessories.....
12409	1144	Thread Take-up Lever Link for 19157....
12415	22301	Lifting Lever Connecting Rod for 12445, 20008 and 20466.....
12416	22301	Lifting Lever Connecting Rod Joint for 12445, 20008 and 20466.....
12424	8689	Oscillating Shaft Crank Slide Block Cap Screw Washer for 19390.....
12427	22302	Arm Shaft.....
12445	-----	Knee Lifter complete (power table or stand No. 25265) Nos. 76D, 766D, 802D, 1521E, 5598, 12237, 12240, 12241, 12250, 12415, 12416 and two 178E....
12453	8645	Arm Oil Tube for intermediate bearing..
12454	8645	" " " with 132590, for oiling 12409.....
12458	8687	Drip Pan with four 1 in. wire nails, for 20141.....
12459	8689	Oscillating Rock Shaft Hinge Pin Oil Hole Stop Screw Washer (leather)..
12475	8687	Driving Arm Pitman for 20141.....
12477	8683	" Attachment Starting Crank Shaft for 44176.....
12479	8683	Driving Attachment Starting Crank for 44176.....
12480	8696	Arm Side Cap.....
12486	8699	Oil Cup Packing (felt) for 24022.....

No.	Plate	Name
13211	8695	Tape Holder Tension Adjusting Spring for 26074.....
14010	8675	Bed Frame Hinge Plate Rivet for 20067..
14081	8687	Driving Attachment Treadle Pitman Rod (upper) for 14233.....
14233	8687	Driving Attachment Treadle Pitman complete for 126213, Nos. 2762, 6055, 14081, 27637, 80223 and 150208.....
15063	8696	Arm Spool Bracket 2415 with two 12403..
15072	8695	Bobbin Winder Bobbin Position Pin for 15077 and 27538.....
15077	8685	Bobbin Winder Spindle with 15072, for 12171, 16515 and 20308.....
15132	8674	Driving Arm Brake Rivet for 16518.....
*15404	-----	Trade Mark for 20013.....
15405	-----	" " Rivet for 20013.....
15783	-----	Arm Oil Tube for 11119.....
16128	8688	Rock Shaft Hanger (front) with two wood screws 1 in. No. 10, for 20465....
16514	8685	Bobbin Winder Frame for 16515.....
16515	8685	Bobbin Winder Frame complete for 19260, Nos. 333D, 5960, 5961, 5963, 15077 and 16514.....
16518	8687	Driving Arm with 2269, 2928 and two 15132, for 19260.....
16524	-----	Driving Attachment Balance Wheel Friction Ring (leather) for 16592....
18530	8685	Driving Attachment Bracket for 19260...
18555	8675	Bed Frame Hinge Plate for 20067.....
18556	8697	Feed Lifting Rock Shaft Crank (back) with 462C, for 20017.....
18592	8687	Driving Attachment Balance Wheel (friction) with 7958, 16524 and two 435C, for 20141.....
18594	8683	Driving Friction Pulley, 2 5/16 in. diam. with 861D and 10236, for 20141.....
17567	5771	Roller Arm Bracket for 19211.....
18014	8698	Needle Bar (hollow).....
19066	8699	Spool Holder Spindle for 26764.....
19067	8699	" " " Thread Guiding Disc for 26764.....
19111	8696	Feed Bar.....
19116	8672	" Dog Spring.....
19117	8672	" " " Hook for 19120.....
19118	8672	" " " " 19306, 20166, 20203, 20205, 43966 and 62505.....
19120	8697	Feed Lifting Rock Shaft Crank (front) with 157E, 19117, 19121 and 19122, for 20017.....

No.	Plate	Name
19121	8672	Feed Lifting Rock Shaft Crank (front) Roller for 19120.....
19122	8672	Feed Lifting Rock Shaft Crank (front) Roller Pin for 19120.....
19124	8691	Needle Clamp with two 460F, for 1/32 in. to 5/64 in. gauge.....
19131	8651	Shuttle (inside) Bobbin for 19324.....
19131	8651	" (outside) Bobbin for 19325 and 19326.....
19136	8651	Shuttle (inside) Body for 19324.....
19137	8650	" (outside) Body for 19325.....
19139	8698	" Driver with two 453C.....
19147	8650	" Race Slide (outside) Friction Spring for 19322.....
19149	8651	Shuttle (inside) Tension Spring for 19312.....
19155	-----	Face Plate Thread Guard (upper) 62624 with 12152, for 19305.....
19156	1144	Thread Take-up Lever for 19157.....
19157	1144	Thread Take-up Lever complete, Nos. 12166, 12409 and 19156.....
19158	8671	Thread Take-up Spring (music wire)....
19159	8671	" Guide Body for 19162.....
19160	8671	" " Roller for 19162.....
19161	8671	" " Cap for 19162.....
19162	-----	Thread Guide complete (roller) Nos. 905D and 19159 to 19161.....
19171	8650	Shuttle (outside) Body for 19326.....
19172	8650	" " Tension Spring for 19313.....
19186	8690	Presser Foot (long toe) for inside stays.....
19191	1146	Tension Plate, for upper tension, with 19231, for 19195.....
19192	1146	Tension Releaser for 19195.....
19193	1146	" Releasing Lever (intermediate) for 19195.....
19194	1146	Tension Releasing Lever (intermediate) Spring for 19195.....
19195	1146	Tension (upper) complete with Tension Release, Nos. 2269, 19191, 19193, 19194, two each 1547D, 2923, 19192, 44209 and four 2921.....
19196	5771	Roller Arm for 19211.....
19197	5771	" " " 19212.....
19198	5771	" " " 19213.....
19199	5771	" " " 19214.....
19200	5771	" " Bracket for 19212 and 19214.

NUMERICAL LIST OF PARTS

No.	Plate	Name	No.	Plate	Name
19201	1210	Roller Needle Guard (flat) 1/32 in. to 1/16 in. gauge, for 19211.....	19308	8691	Needle Clamp with two 209F and 460F, for 3/32 in. gauge and above.....
19204	1210	Roller Needle Guard (flat) 1/32 in. to 1/16 in. gauge, for 19213.....	19309	1213	Shuttle Race Needle Guard for 19323 and 24013.....
19207	1210	Roller Needle Guard (round) 1/32 in. to 1/16 in. gauge, for 19211.....	19310	8651	Shuttle (inside) Bobbin Case Latch and Position Finger for 19312.....
19208	1210	Roller Needle Guard (round) 3/32 in. to 1/4 in. gauge, for 19212 and 19214	19311	8651	Shuttle (outside) Bobbin Case Latch and Position Finger for 19313.....
19209	1210	Roller Needle Guard (round) 1/32 to 1/16 in. gauge, for 19213.....	19312	8651	Shuttle (inside) Bobbin Case complete for 19324, Nos. 591F, 592E, 2521, 19149, 19310 and 62606.....
19211	1209	Roller Presser complete, 1 1/4 in. roller, for 1/32 to 1/16 in. gauge, Nos. 171F, 176D, 207F, 440F, 1549J, 1903, 7556, 17567, 19196, 19201, 19207, two 316F and three 1547J.....	19313	8651	Shuttle (outside) Bobbin Case complete for 19325 and 19326, Nos. 591F, 592E, 2521, 19172, 19311 and 62608...
19212	1209	Roller Presser complete, 1 1/4 in. roller, for 3/32 in. to 1/4 in. gauge, Nos. 171F, 176D, 440F, 1549J, 1903, 7556, 19197, 19200, 19208, two 316F and three 1547J.....	19315	----	Shuttle Race Body with 19316, for 19323
19213	1209	Roller Presser complete, 1 1/2 in. roller, for 1/32 in. to 1/16 in. gauge, Nos. 171F, 176D, 207F, 440F, 1549J, 1875, 4777, 7556, 19198, 19204, 19209, two 316F and three 1547J.....	19316	1213	" " Loop Separator for 19315..
19214	1209	Roller Presser complete, 1 1/2 in. roller, for 3/32 in. to 1/4 in. gauge, Nos. 171F, 176D, 440F, 1549J, 1875, 7556, 19199, 19200, 19208, two 316F and three 1547J.....	19317	1213	" " Ring (inside) for 19323 and 24013.....
19219	8675	Bed Frame Cushion (leather) for 20067..	19318	1213	Shuttle Race Ring (outside) for 19323, 24013 and 24014.....
19220	8675	" " " Spring for 20067....	19319	8698	Shuttle Race Slide (inside).....
19221	8680	Wrench for 936 and 1619 (Accessories)..	19320	8691	" " " " Stop Stud..
19226	8675	Bed Frame Hinge Connection for 19398...	19321	8691	" " " " " " " "
19231	1146	Tension Releasing Lever (intermediate) Hinge Block for 19191.....	19322	8698	Spring.....
19258	8683	Bobbin Winder Stop Latch with 152F and 1550H, for 19260.....	19322	8698	Shuttle Race Slide (outside) with 662D and 19147.....
19260	----	Driving Arm complete for 20141, Nos. 32D 75D, 180F, 427E, 693D, 1508C, 1579C, 12170, 12178, 16515, 16518, 16530, 19258 and 27303.....	19323	1213	Shuttle Race complete, for 3/32 in. to 5/32 in. gauge, Nos. 19309, 19315, 19317, 19318, two each 907D, 1053D, 2533 and four 2532.....
19304	----	Face Plate for 19305.....	19324	8651	Shuttle (inside) 1 11/16 in. diam. Nos. 19131, 19136 and 19312.....
19305	8696	Face Plate complete, Nos. 19155, 19304 and 19327.....	19325	8650	Shuttle (outside) 1 11/16 in. diam. for 7/32 in. gauge and above, Nos. 19131 19137 and 19313.....
19306	8692	Feed Dog, 10 teeth (16 teeth to the inch) with 19118, for 1/32 in. to 3/16 in. gauge, for vamping, for 20128.	19326	8650	Shuttle (outside) 1 11/16 in. diam. for 1/32 in. to 13/64 in. gauge, Nos. 19131, 19171 and 19313.....
			19327	8672	Face Plate Thread Guard (lower) with 12152, for 19305.....
			19333	8690	Presser Foot for inside stays.....
			19379	----	Shuttle Race Body for 19382, 24013 and 24014.....
			19380	1214	Shuttle Race Ring (inside) for 19382 and 24014.....
			19381	1214	Shuttle Race Ring (outside) for 19382..
			19382	1214	Shuttle Race complete, for 1/32 in. to 5/64 in. gauge, Nos. 19379 to 19381 two each 907D, 2533 and four 2532..

No.	Plate	Name
*19386	8698	Oscillating Rock Shaft for 19387.....
19387	-----	Oscillating Rock Shaft complete, Nos. 4784, 12388 and 19386.....
19388	8689	Oscillating Shaft Crank complete, Nos. 457C, 1518E, 19390 and 19496.....
19389	8689	Oscillating Shaft Crank Slide Block for 19390.....
19390	-----	Oscillating Shaft Crank Slide Block complete, for 19388, Nos. 226D, 969C, 12424 and 19389.....
19397	8675	Bed Frame Hinge Connection Cap for 19398
19398	-----	" " " " 19226 with 211E and 19397, for 20067.....
19476	8690	Presser Foot (spring presser) for 19478.
19477	8690	" " " " Bracket with 465C, for 19478.....
19478	8690	Presser Foot (spring presser) complete, Nos. 1607D, 4460 to 4462, 19476 and 19477.....
19496	-----	Oscillating Shaft Crank for 19388.....
20008	-----	Foot Lifter complete, Nos. 76D, 766D, 902D 1521E, 4880, 4885, 5598, 5670, 12237, 12240, 12241, 12415, 12416 and two 178E.....
*20013	-----	Arm with 11104, 15404 and two 15405.....
20016	22302	Oscillating Shaft.....
20017	-----	Feed Lifting Rock Shaft complete, Nos. 12374, 16556 and 19120.....
20023	8698	Presser Bar Spring (heavy) .063 wire....
*20026	-----	Bed.....
20051	8690	Presser Foot with keel, slotted for tape for staying.....
20067	819	Bed Frame with two each 16555, 19398, four each 19219, 19220, six each 14010 wood screws 1 1/4 in. No. 12 and eight 158C.....
20091	8688	Rock Shaft for 20465.....
20126	-----	Throat Plate Body for 20128.....
20127	8692	" " Loop Separator for 20128...
20128	8692	Throat Plate complete for 19306 and 62505, Nos. 219D, 20126 and 20127...
20141	-----	Driving Attachment with Bobbin Winder and Treadle complete, Nos. 210D, 692D 12475, 16592, 16594, 19260, 20372, 24355 27072, 27308, 44176, 126213 and two 65D.....
20166	8694	Feed Dog, 16 teeth (16 teeth to the inch) with 19118, for 3/32 in. to 3/16 in. gauge, for 20167.....

No.	Plate	Name
20167	8694	Throat Plate for 20166.....
20188	8697	Needle Bar Crank with 858C and 1065C....
20197	8697	Crank Connecting Rod with two 896C.....
20199	-----	Presser Foot Plate for 20200.....
20200	8690	Presser Foot (hinged) complete, for inside stays, Nos. 20199, 26275 and 26276.....
20203	8693	Feed Dog, 14 teeth (16 teeth to the inch) with 19118, for 3/32 in. to 3/16 in. gauge, for vamping, for 20204..
20204	8693	Throat Plate for 20203.....
20205	8694	Feed Dog, 16 teeth (16 teeth to the inch) with 19118, for 3/32 in. to 1/4 in. gauge, for shoe staying, for 20206.....
20206	8694	Throat Plate for 20205.....
20287	-----	Presser Foot Plate for 20288.....
20288	8690	Presser Foot (hinged) complete with keel slotted for tape, for staying, Nos. 20287, 26275 and 26276.....
20307	8685	Bobbin Winder Frame for 20308.....
20308	8685	Bobbin Winder Frame complete, for 20309, Nos. 333D, 5960, 5961, 5963, 15077 and 20307.....
20309	-----	Bobbin Winder complete for 12358, Nos. 32D, 180F, 12168, 12170 and 20308....
20333	-----	Feed Rock Shaft complete, Nos. 12379 and 29633.....
20371	8683	Driving Arm Pitman Crank for 44176.....
20372	8683	" " " " Spring for 20141
20376	8690	Presser Foot, for shoe tips.....
20462	8688	Rock Shaft Knee Arm Hub with 356C, for 20463.....
20463	-----	Rock Shaft Knee Arm complete for 20465, Nos. 2765, 2767 and 20462.....
20464	8688	Rock Shaft Lifting Arm with 356C, for 20465.....
20465	8688	Rock Shaft complete for 20466, Nos. 2764 16128, 20091, 20463, 20464 and two 2770.....
20466	-----	Knee Lifter complete (stand No. 25255) Nos. 76D, 766D, 802D, 1521E, 5598, 12237, 12240, 12241, 12415, 12416, 20465 and two 178E.....
23258	8674	Driving Attachment Treadle Bracket (left) Hook Friction Washer for 126206.....

No.	Plate	Name
24013	1215	Shuttle Race complete, for 11/84 in. gauge and above, Nos. 19309, 19317, 19318, 19379, two each 907D, 1053D, 2533 and four 2532.....
24014	1215	Shuttle Race complete, for 3/32 in. to 3/16 in. gauge, for vamping, Nos. 19318, 19379, 19380, two each 907D, 2533 and four 2532.....
*24020	8697	Oil Cup for 24022.....
24021	8697	" " Extension for 24022.....
24022	8697	Oil Cup complete for 44231, Nos. 12486, 24020 and 24021.....
24129	1144	Thread Take-up Crank.....
24131	8645	Arm Oil Tube with 52045, for oiling 12197.....
24355	8683	Driving Attachment Balance Wheel Oil Cover for 20141.....
26026	8630	Screw Driver (large) Accessories.....
26061	989	Tape Holder Bracket Wire with Disc for 26063.....
26062	989	Tape Holder Disc (adjustable) with 35925 and 51224D, for 26063.....
26063	989	Tape Holder (straight) 8 in. disc, complete, for 26065, Nos. 26081 and 26062.....
26064	8699	Tape Holder Foot with 736J and three wood screws 1 in. No. 12, for 26343
26065	-----	Tape Holder with Foot complete, Nos. 26063 and 26325.....
26066	989	Tape Holder Bracket Wire for 26067.....
26067	-----	Tape Holder Bracket Wire complete for 26074, Nos. 26066, 26068 and 26072..
26068	989	Tape Holder Disc for 26067 and 26071....
26069	989	" " " " Hub for 26071.....
26070	-----	" " " " Rivet for 26071....
26071	-----	Tape Holder Disc complete for 26074, Nos. 26068 and 26069.....
26072	989	Tape Holder Tape Guide for 26067.....
26073	8695	" " Tension Adjusting Collar with 51224B, for 26074.....
26074	989	Tape Holder (offset) 10 in. disc, complete for 26343, Nos. 13211, 26067, 26071 and 26073.....
26266	8699	Stay Guide Plate (lower) for 26288.....
26267	8699	" " " (upper) for 26288.....
26268	-----	Stay Guide complete, Nos. 26266 and 26267
26275	-----	Presser Foot Shank for 20200 and 20288..
26276	8690	" " Hinge Pin for 20200, 20288 and 43972.....

No.	Plate	Name
26325	8699	Tape Holder Foot with 736J and three wood screws 1 in. No. 12, for 26065
26343	-----	Tape Holder with Foot complete, Nos. 26064 and 26074.....
26485	8680	Screw Driver (small) Accessories.....
26763	8699	Spool Holder Bracket with 219F and 50053D, for 26764.....
26764	8699	Spool Holder (disc) complete, Nos. 691F, 19066, 19067 and 26763.....
27072	-----	Driving Attachment Shaft Driving Pulley (sectional, grooved) 12 in. diam., 1 13/16 in. bore, with two 597C, for 20141.....
27302	8699	Bobbin Winder Frame for 27875.....
27303	8676	" " " Spring for 27875....
27303	8676	" " Stop Latch Spring for 19260.....
27306	8686	Bobbin Winder Spool Pin for 27308.....
27307	8686	" " " Stand for 27308.....
27308	8686	Bobbin Winder Spool Stand complete for 20141 and 27876, Nos. 418E, 1562J, 2106, 10141, 11241, 27306, 27307, two each 2455 and wood screws 1 in. No. 10.....
27538	8699	Bobbin Winder Spindle 27849 with 15072, 27850 and 41828, for 27875.....
27540	8699	Bobbin Winder Base for 27875.....
27541	8699	" " Pulley for 27875.....
27587	8686	" " Stop Latch for 27875.....
27637	8687	Driving Attachment Treadle Pitman Rod (lower) for 14233.....
27739	22301	Thread Unwinder Thread Cone (wood) for large cones.....
*27849	-----	Bobbin Winder Spindle for 27538.....
*27850	-----	" " " Collar for 27538..
27875	-----	" " Nos. 35D, 1620J, 27302, 27303 27538, 27540, 27541, 27587, 50356D and two wood screws 1 in. No. 7, for 27876.....
27876	-----	Bobbin Winder (swinging automatic, right hand) complete for 19131, for stand Nos. 27308 and 27875.....
28994	2116	Tape Holder (5 in. disc) complete for under the bench, Nos. 55D, 36795, 36796 and two wood screws 1 1/4 in. No. 10.....
29633	8697	Feed Rock Shaft Crank with 157J, for 20333.....
35925	8695	Tape Holder Disc Hub for 26062.....

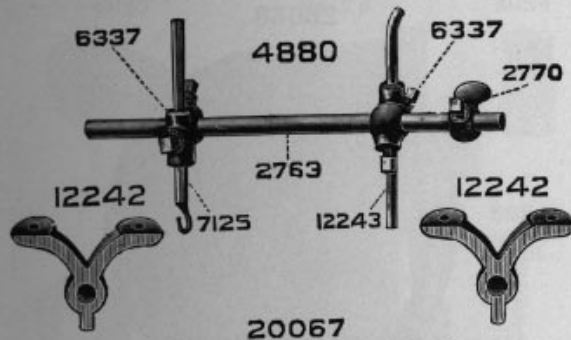
No.	Plate	Name
36795	2116	Tape Holder Body for 28994.....
36796	2116	" " Cover for 28994.....
41400	8680	Machine Rest Pin (wood) Accessories.....
41828	8695	Bobbin Winder Spindle Collar Pin for 27538.....
41929	22302	Belt Guard for 41931.....
41930	8688	" " Hinge for 41931.....
41931	-----	Belt Guard complete, Nos. 8420,41929,two 41930 and four wood screws 3/4 in. No. 9.....
43944	8696	Tension Releasing Lever.....
43966	8693	Feed Dog,15 teeth (16 teeth to the inch) with 19118, for 5/32 in. to 1/4 in. gauge, for 43967.....
43967	8693	Throat Plate for 43966.....
43970	-----	Presser Foot Plate for 43972.....
43971	-----	" " Shank for 43972.....
43972	8690	Presser Foot (hinged) long toe complete, for inside stays, Nos. 26276, 43970 and 43971.....
43976	8697	Feed Lifting Rock Shaft Crank Connecting Rod (cast iron) with two 966E.....
44139	8675	Machine Hinge Plate for 44140 and 44180, (Accessories).....
44140	-----	Machine Hinge complete, Nos. 12361,44139 and merlized wood screw 1 1/4 in. No. 14 (Accessories).....
*44176	-----	Driving Attachment Starting Crank Shaft 12477, with 12479,20371 and two 2022, for 20141.....
44180	-----	Machine Hinge complete, Nos. 6055, 12361 44139 and 51075E (Accessories).....
44209	-----	Tension Screw Stud 916C with 1560C, for 19195.....
44212	8678	Drip Pan with four 1 in. wire nails.....
44224	8697	Oil Cup Thread Retainer for 44231.....
44231	-----	" " 24022 with 44224.....
46681	8683	Driving Attachment Treadle Bracket (right) for 60502.....
50053D	8695	Spool Holder Bracket Thumb Screw for 26763.....
50302J	8691	Finger Guard Holder Set Screw for 120858
50356D	8676	Bobbin Winder Frame Hinge Screw for 27875.....
51075E	8675	Machine Hinge Bolt with 51581E,for 44180 (Accessories).....
51224D	8645	Arm Side Cover Thumb Screw.....
51224D	8645	Face Plate Thumb Screw.....

No.	Plate	Name
51224D	8645	Tape Holder Disc Hub Thumb Screw for 26062.....
51224B	8645	Tape Holder Tension Adjusting Collar Thumb Screw for 26073.....
51581E	-----	Machine Hinge Bolt Nut for 51075 (Accessories).....
52018	8698	Presser Bar Lifter.....
52045	8645	Arm Oil Tube Packing (wick) for 11119 and 24131.....
56848	-----	Bell Crank 5596 with 5599 and 5601, for 5598.....
56864	22301	Chain Hook (large) for 5670.....
56865	22301	" " (small) for 5670.....
60502	-----	Driving Attachment Treadle Bracket (right) 46681 with two wood screws 1 in. No. 14, for 126209.....
62505	8692	Feed Dog, 8 teeth (12 teeth to the inch) with 19118, for 1/32 in. to 3/16 in. gauge, for vamping, for 20128..
62606	-----	Shuttle (inside) Bobbin Case for 19312..
62608	-----	" (outside) Bobbin Case for 19313.
62624	8672	Face Plate Thread Guard (upper) for 19155.....
80223	8687	Driving Attachment Treadle Pitman Rod Clamp with 361C, for 14233.....
120341	8680	Tweezers (curved) Accessories.....
120346	8680	Oiler (copper plated) with 120347 (Accessories).....
120347	8680	Oiler Spout, 8 1/2 in. long, for 120346 (Accessories).....
120858	8696	Finger Guard Holder with 50302J, for 121350.....
121349	8696	Finger Guard for 121350.....
121350	8696	Finger Guard complete, Nos. 120858, 121349 and two 236J.....
126036	8678	Driving Attachment Treadle for 126209...
126205	8683	" " " Bracket (left) for 126206.....
126206	-----	Driving Attachment Treadle Bracket (left) complete, for 126209, Nos. 23258,126205,126207,126208 and two wood screws 1 in. No. 14.....
126207	8683	Driving Attachment Treadle Bracket (left) Hook for 126206.....
126208	8674	Driving Attachment Treadle Bracket (left) Hook Rivet for 126206.....
126209	-----	Driving Attachment Treadle complete for 126213, Nos. 60502,126036 and 126206.....

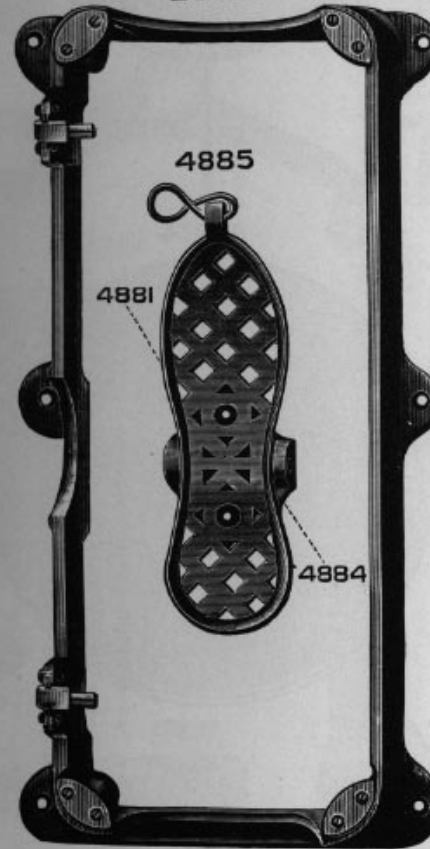
No.	Plate	Name
126213	-----	Driving Attachment Treadle and Pitman complete for 20141, Nos. 14233 and 126209.....
132590	8645	Arm Oil Tube Packing (wick) for 12454...
150203	8755	Thread Unwinder Spool Rest Cushion (felt) for 259143.....
150208	8685	Driving Attachment Treadle Pitman Rod (lower) Spring for 14233.....
200056E	8676	Bobbin Winder Stop Latch Screw for 225382.....
200082D	8676	Bobbin Winder Tension Bracket Screw for 225382.....
200299H	8676	Bobbin Winder Stop Latch Trip Lever Hinge Screw for 225382.....
200380C	8676	Bobbin Winder Pulley Set Screw for 202473.....
200383C	8671	Thread Unwinder Spool Rest Rod Set Screw for 202490.....
201018C	8671	Thread Unwinder Spool Rest Set Screw for 225257 and 225259.....
201499B	8686	Bobbin Winder Tension Stud for 225461...
201572B	8676	" " " " Thumb Nut for 225462.....
201696	8671	Thread Unwinder Thread Guide Lock Nut for 259143.....
202277	8676	Bobbin Winder Frame Oil Packing (wick) for 225453.....
202407	8676	Bobbin Winder Tension Spring for 225462.
202473	8686	" " Pulley with 200380C, for 225382.....
202478	8686	Bobbin Winder Stop Latch Trip Lever for 225382.....
202490	8755	Thread Unwinder Spool Stand with 200383C for 259143.....
225257	8755	Thread Unwinder Spool Rest (for two spools) with 201018C, for 259143...
225259	8755	Thread Unwinder Spool Rest (for one spool) with 201018C, for 259143....
225322	8671	Thread Unwinder Thread Guide Rod Washer for 225324.....
225324	8755	Thread Unwinder Thread Guide Rod with 208E and 225322, for 259143.....
225326	8695	Thread Unwinder Thread Guide Position Cup for 259143.....
225381	8686	Bobbin Winder Spindle for 225382.....

No.	Plate	Name
225382	8678	Bobbin Winder (swinging automatic, right hand) complete for 19131, for power table, Nos. 200056E, 200082D, 200299H, 202473, 202478, 225381, 225433, 225444, 225453 to 225456, 225458, 225462, 228026, two each 225459 and wood screws 3/4 in. No. 12 R.H.B.....
225388	8755	Thread Unwinder Spool Rest Rod for 259143.....
225390	22301	Thread Unwinder Thread Cone Holder for inverted cones.....
225391	8755	Thread Unwinder Thread Guide for 259143.
225433	8678	Bobbin Winder and Tension Bracket Base for 225382.....
225438	8676	Bobbin Winder Frame Oil Well Cap for 225453.....
225444	8686	Bobbin Winder Stop Latch for 225382.....
225453	8686	" " Frame with 202277 and 225438, for 225382.....
225454	8686	Bobbin Winder Frame Hinge Pin for 225382
225455	8676	" " " Spring for 225382...
225456	8676	" " " " Plunger for 225382.....
225458	8686	Bobbin Winder Stop Latch Thumb Lever for 225382.....
225459	8676	Bobbin Winder Stop Latch Thumb Lever Hinge Stud for 225382.....
225459	8676	Bobbin Winder Stop Latch Thumb Lever Joint Stud for 225382.....
225461	8686	Bobbin Winder Tension Bracket with 201499B, for 225462.....
225462	-----	Bobbin Winder Tension Bracket complete for 225382, Nos. 201572B, 202407, 225461 and two 2102.....
228026	8676	Bobbin Winder Tension Bracket Screw Washer for 225382.....
259143	8755	Thread Unwinder complete, for three spools, Nos. 201696J, 202490, 225257, 225259, 225324, 225326, 225388, three each 150203, 225391 and wood screws 7/8 in. No. 12.....

PLATE 819—ONE-FOURTH SIZE



20067



SINGER Needles should be used
in SINGER Machines
These Needles and their Containers
are marked with the
Company's Trade Mark "SIMANCO.**" 1

Needles in Containers marked
"FOR SINGER MACHINES"
are NOT SINGER made needles. 2

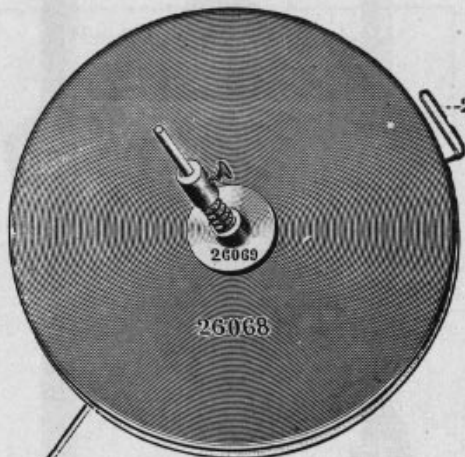
PLATE 989—ONE-FOURTH SIZE

26063



---26061

26074



--26072

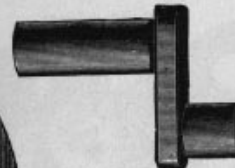
----26066

PLATE 1144—FULL SIZE

19157



24129



3094



690



19156



12156



11204



430



12409



12382



794



1904



775



12384

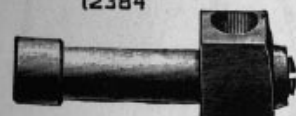


PLATE 1146—FULL SIZE



PLATE 1209—FULL SIZE

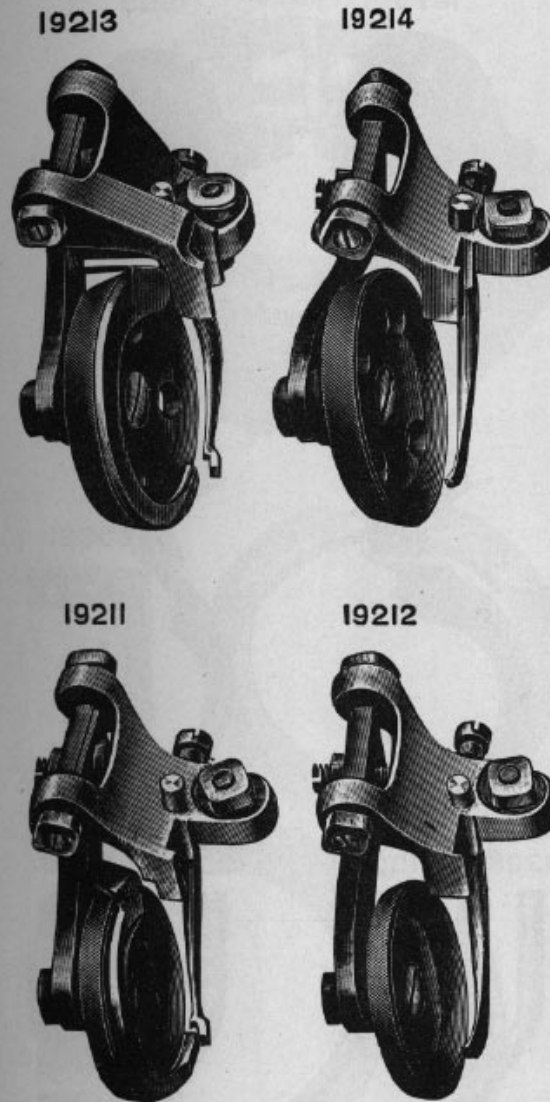


PLATE 1210—FULL SIZE

1875



1903



19204



19201



19208



19207



19209

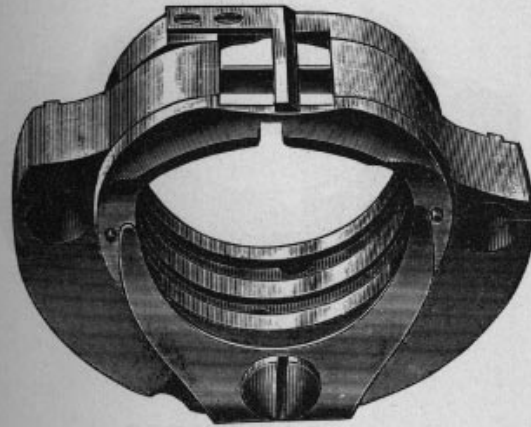


7556



PLATE 1213—FULL SIZE

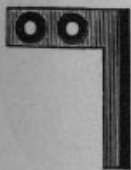
19323



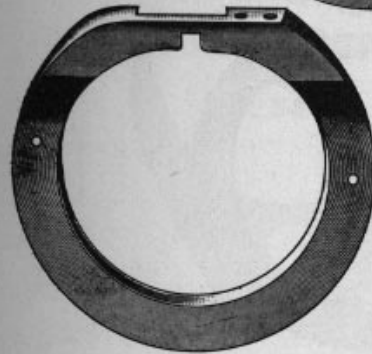
19318



19309



19317

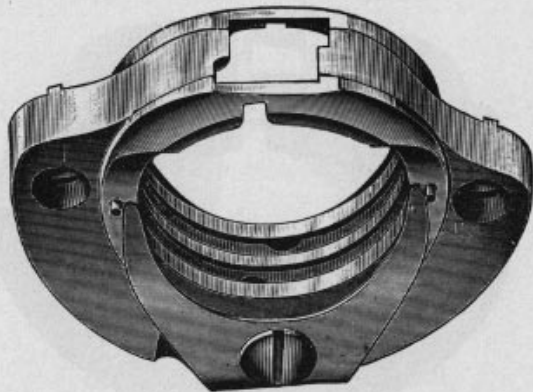


19316

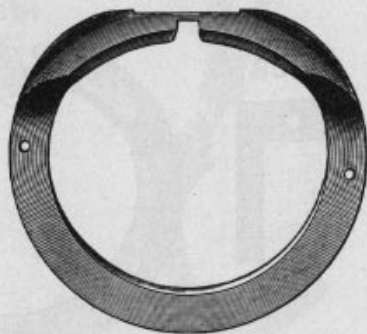


PLATE 1214—FULL SIZE

19382



19380



19381

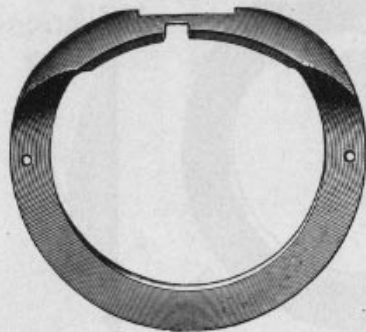
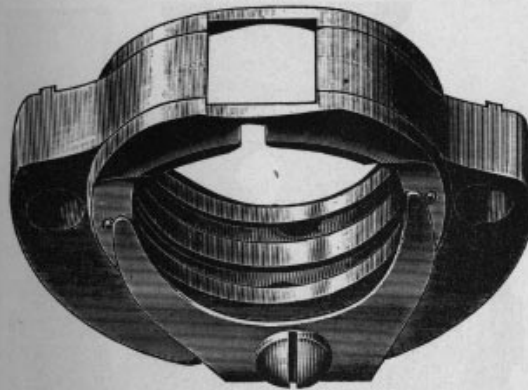
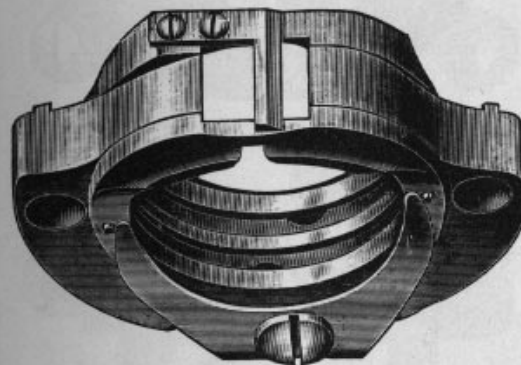


PLATE 1215—FULL SIZE

24014



24013



2533

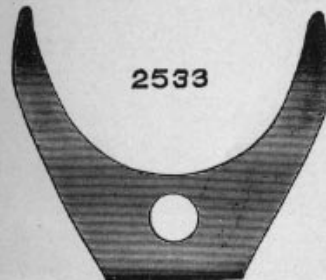


PLATE 2116—ONE-HALF SIZE

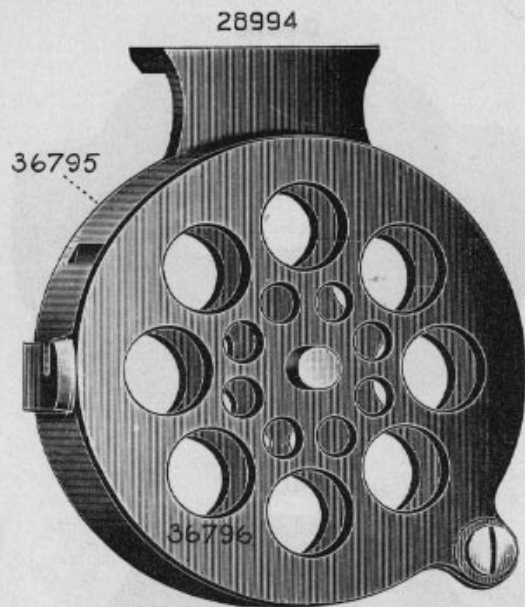


PLATE 5771—FULL SIZE

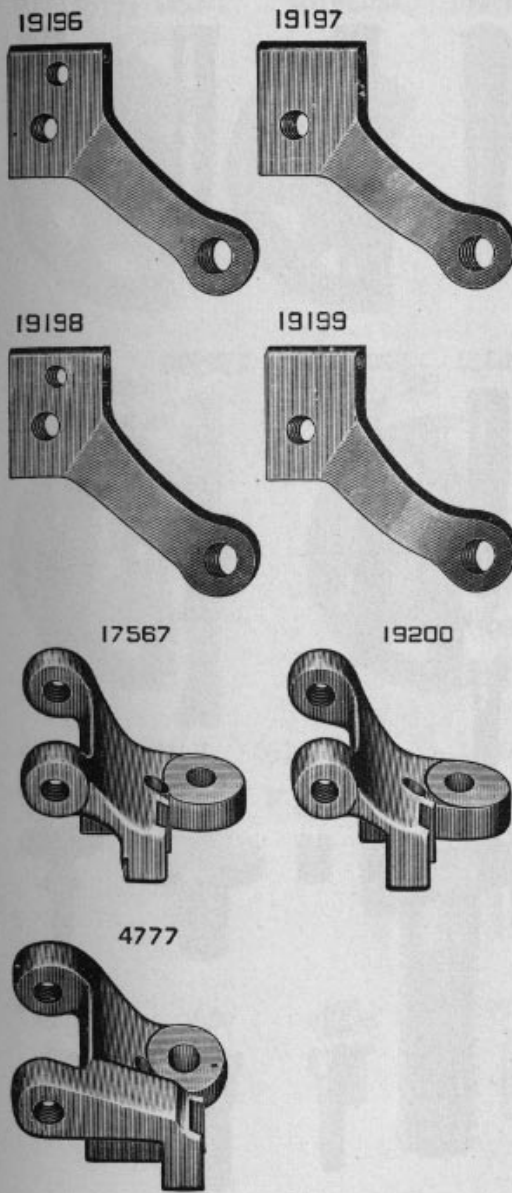
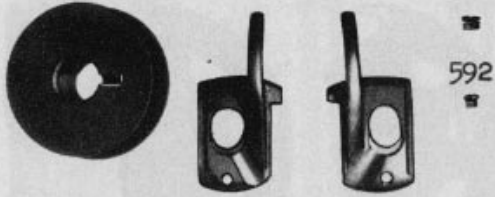


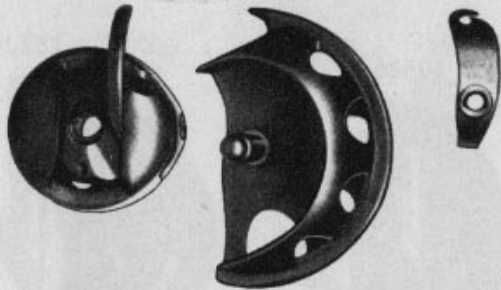
PLATE 8651-FULL SIZE

19131 19310 19311 591



592

19312 19136 19149



19324 19313

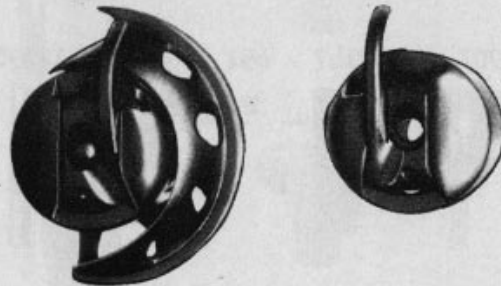
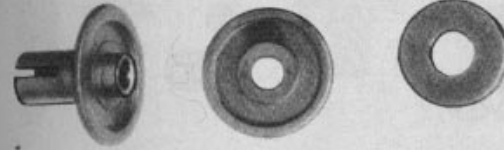
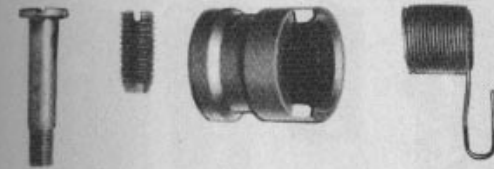


PLATE 8671-FULL SIZE

19159 19161 19160



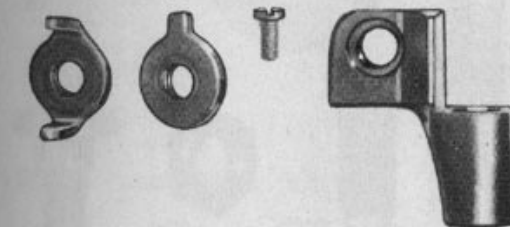
905 435 7336 19158



766 356 200383 201018



201696 225322 208 12327



12149 12241



PLATE 8672-FULL SIZE

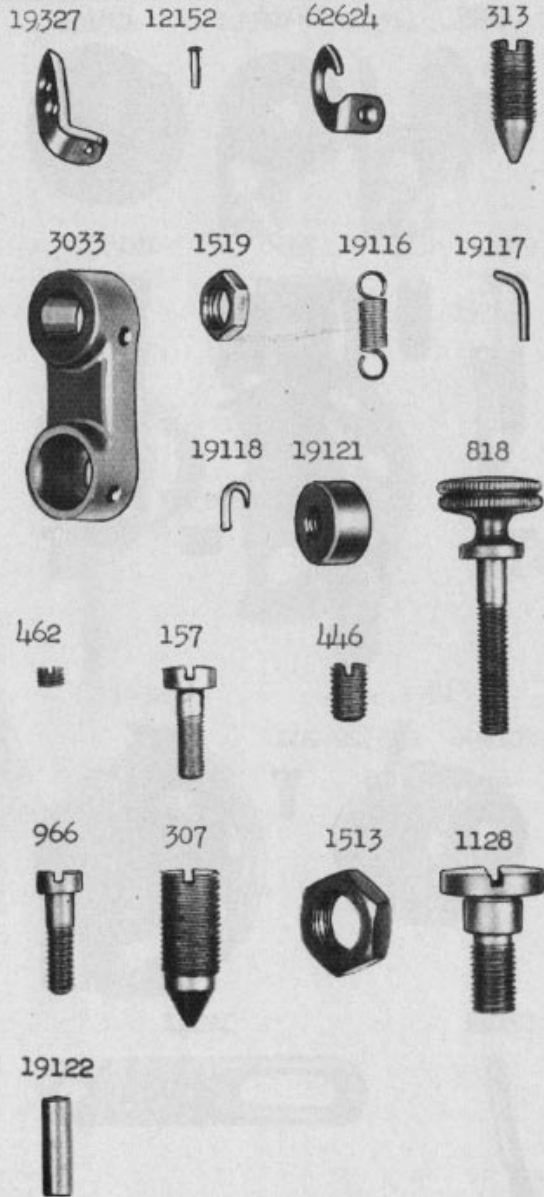


PLATE 8674-FULL SIZE

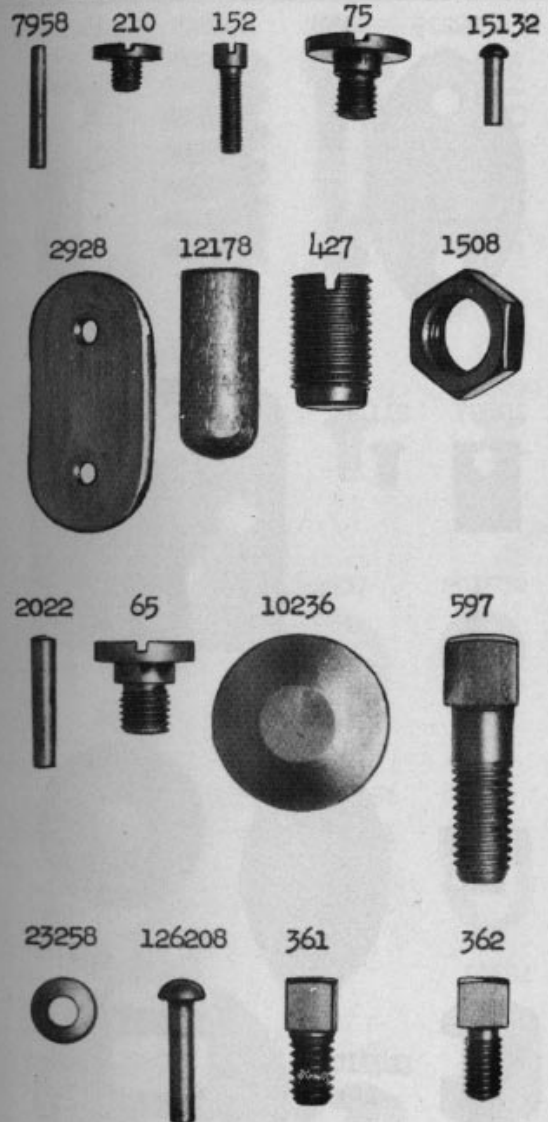


PLATE 8675-FULL SIZE

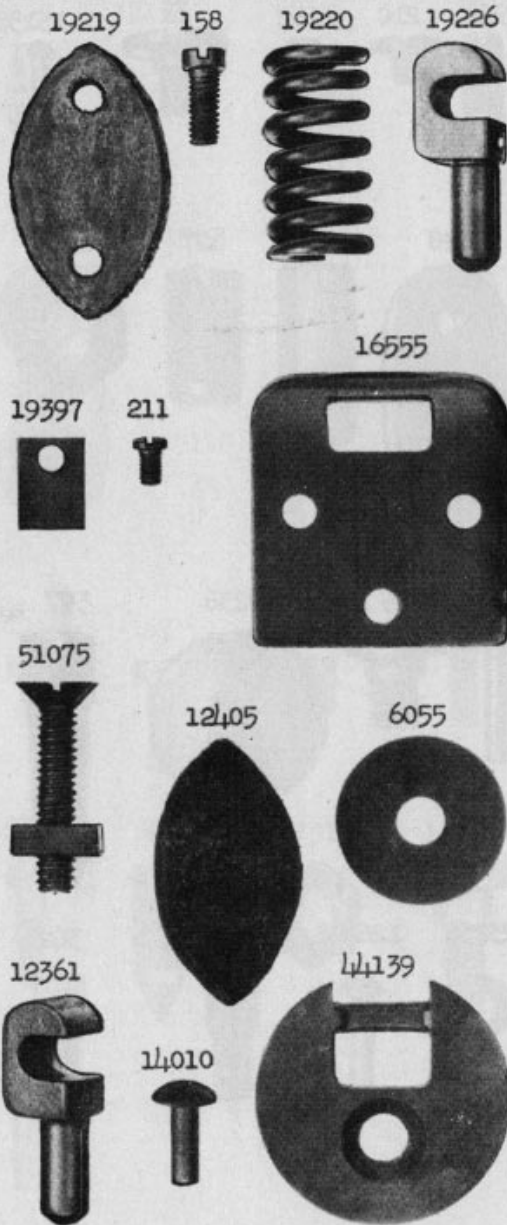


PLATE 8676-FULL SIZE



PLATE 8678-ONE-FOURTH SIZE

126036



225382

44212

225433

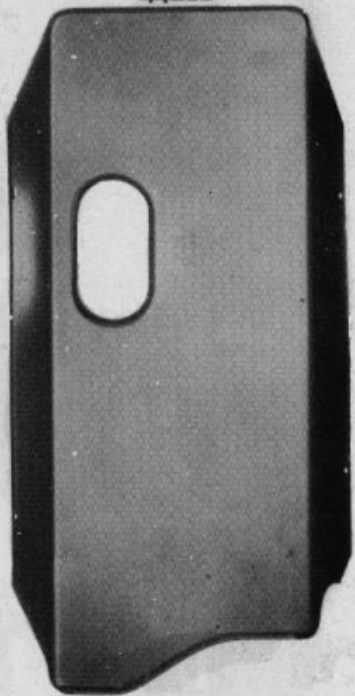


PLATE 8680-ONE-HALF SIZE

19221

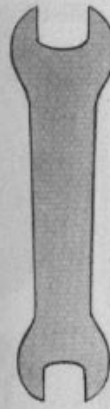
8909

120346

411400



26026



120341



26485



120347



8908

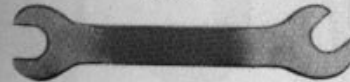


PLATE 8683-ONE-HALF SIZE

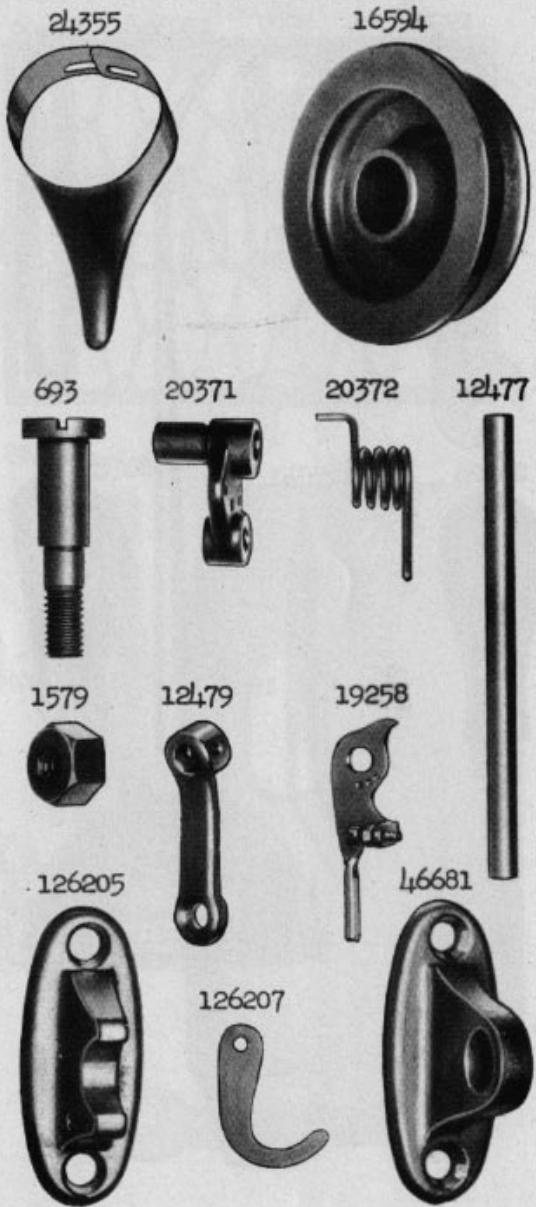


PLATE 8684-ONE-HALF SIZE

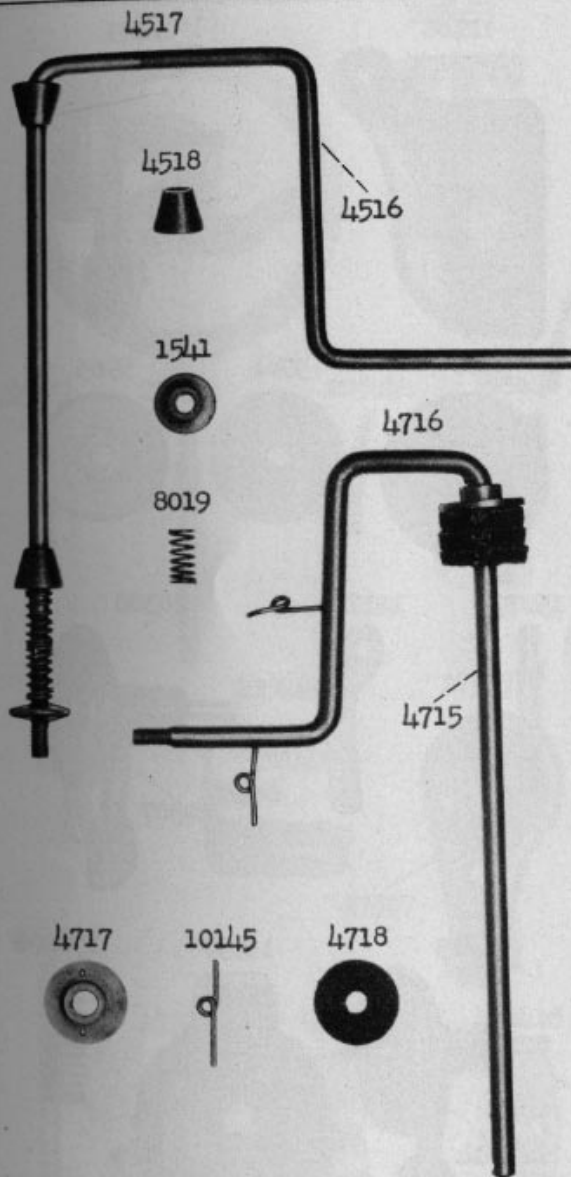
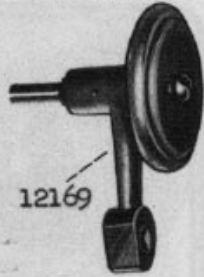


PLATE 8685-ONE-HALF SIZE

12168



12171



12169

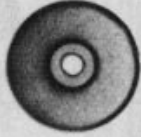
5960



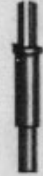
5961



5963



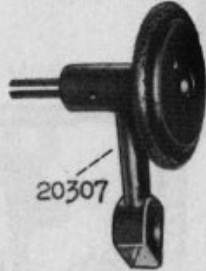
15077



12170

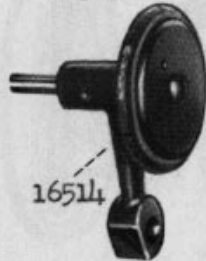


20308



20307

16515



16514

16530



150208



PLATE 8686-ONE-HALF SIZE

202473



225453



225454



225381



225444



225458



202478



225461



201499

27308



27307

27306



27587



41930



8418



PLATE 8687-ONE-FOURTH SIZE

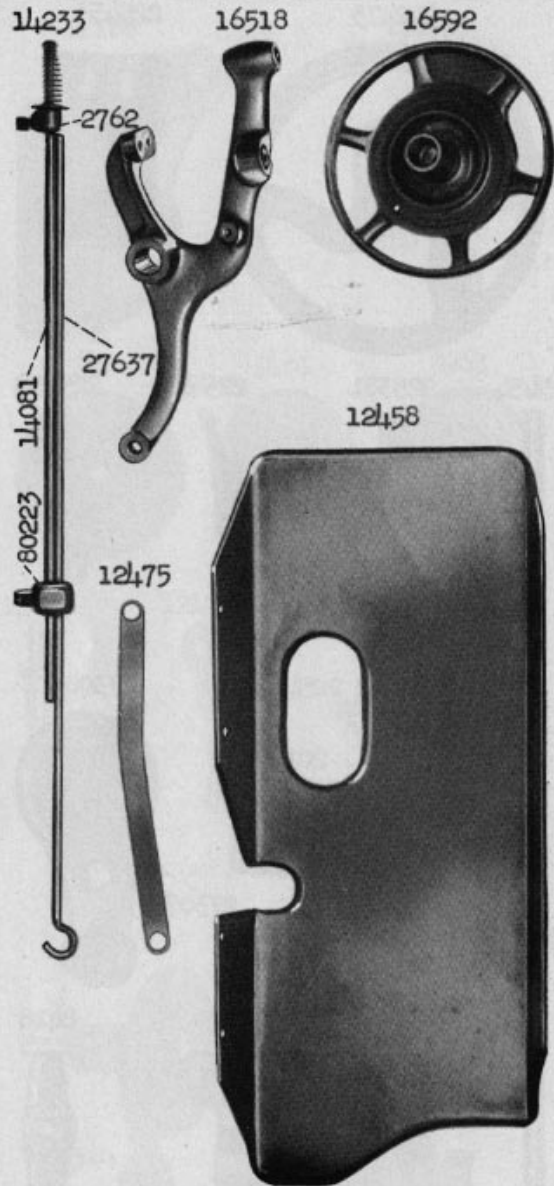


PLATE 8688-ONE-FOURTH SIZE

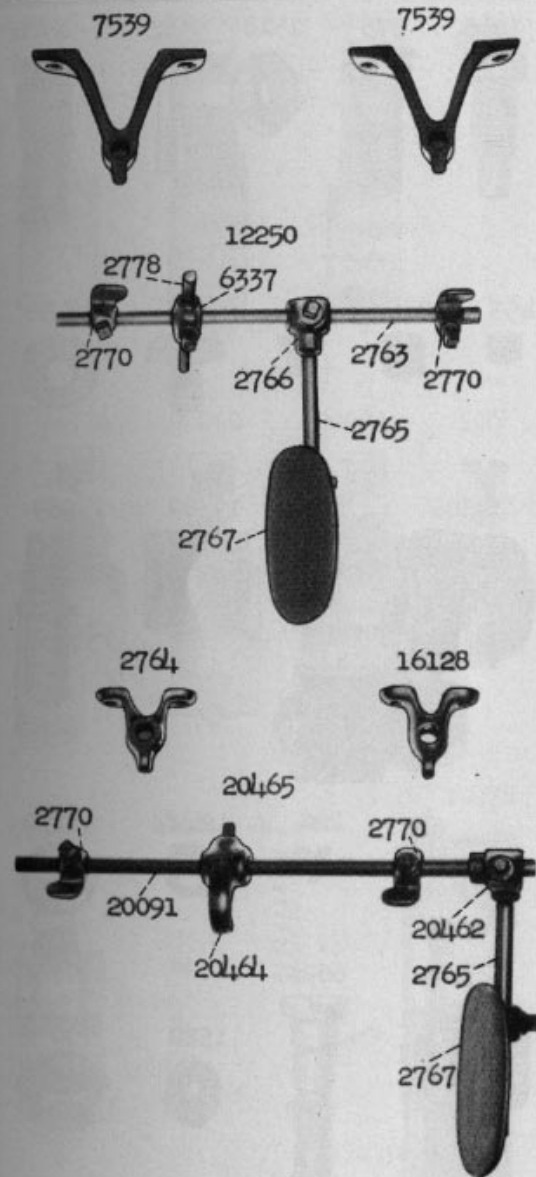


PLATE 8689-FULL SIZE

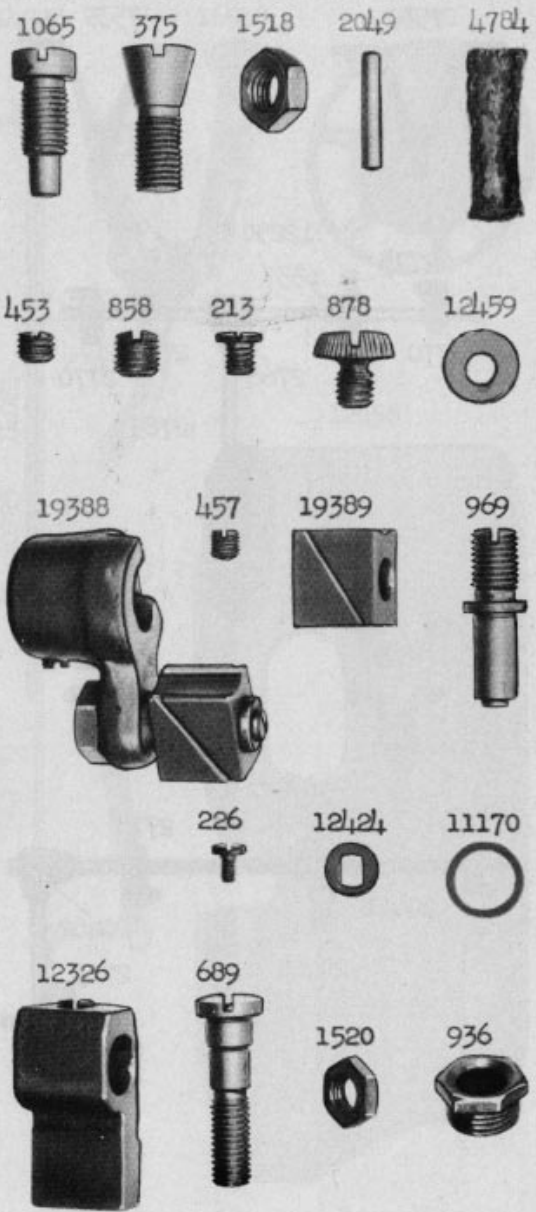


PLATE 8690-FULL SIZE

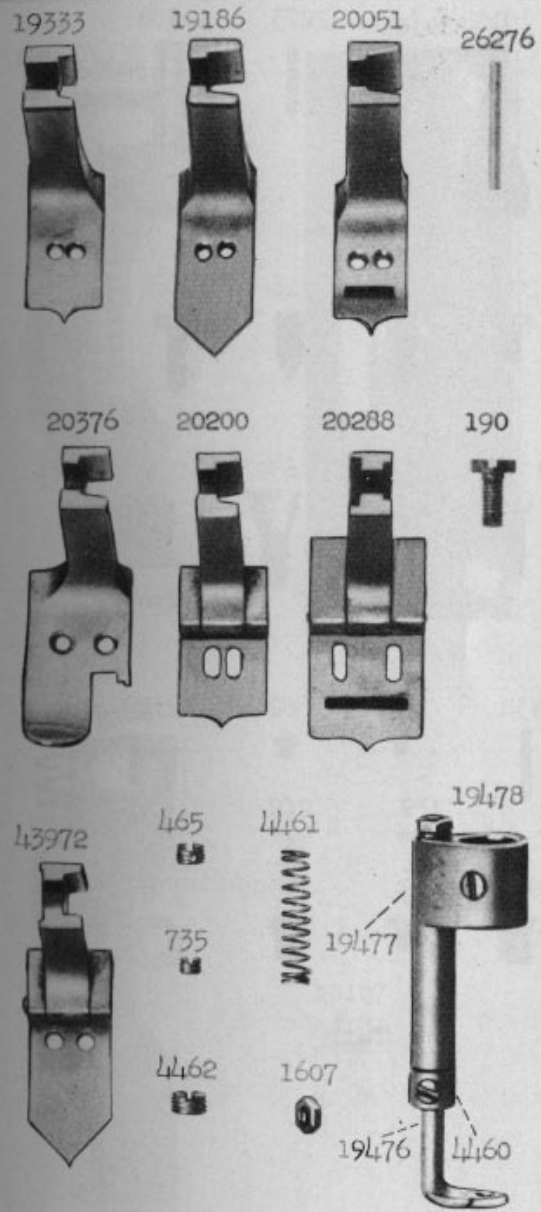
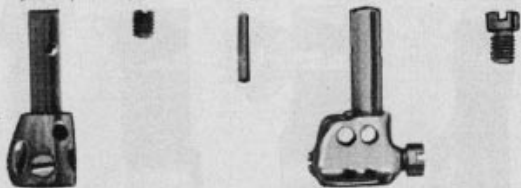


PLATE 8691-FULL SIZE

19124 460 2273 19308 209



207 440 316 176 1549



171 634 652 1528 2521



2532 1053 662 19320 19321

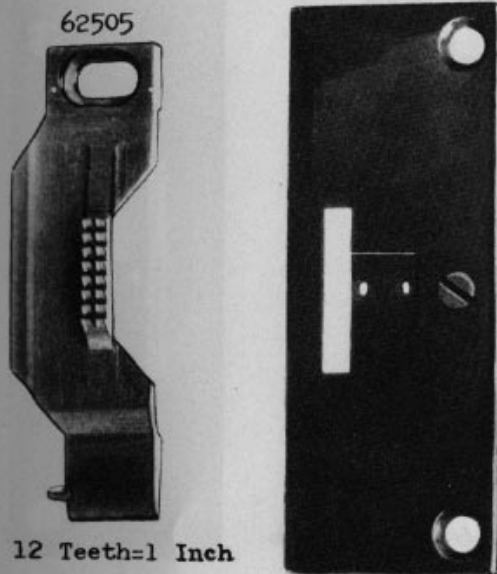


861 236 50302 7071 193



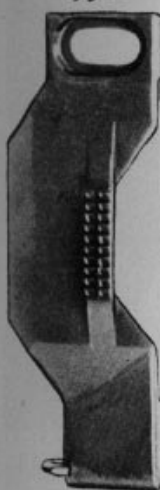
PLATE 8692-FULL SIZE

20128



12 Teeth=1 Inch

19306



16 Teeth=1 Inch

219



231

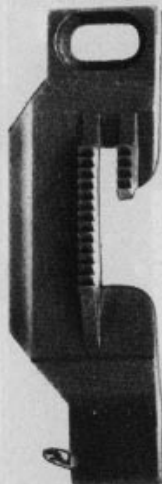


20127



PLATE 8693-FULL SIZE

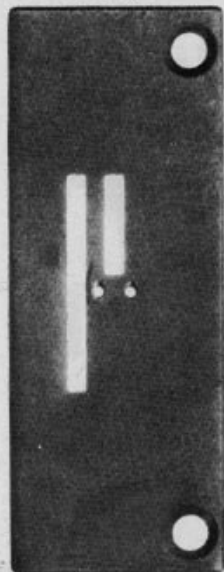
20203



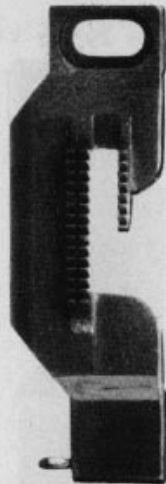
16 Teeth=1 Inch

43967

20204



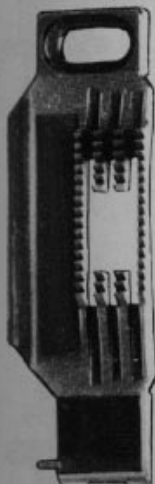
43966



16 Teeth=1 Inch

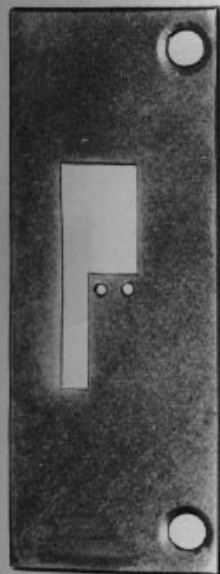
PLATE 8694-FULL SIZE

20205

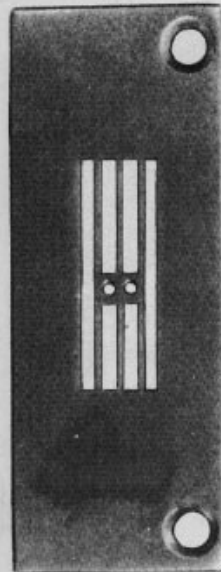


16 Teeth=1 Inch

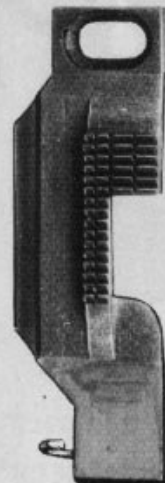
20167



20206



20166



16 Teeth=1 Inch

PLATE 8695-FULL SIZE

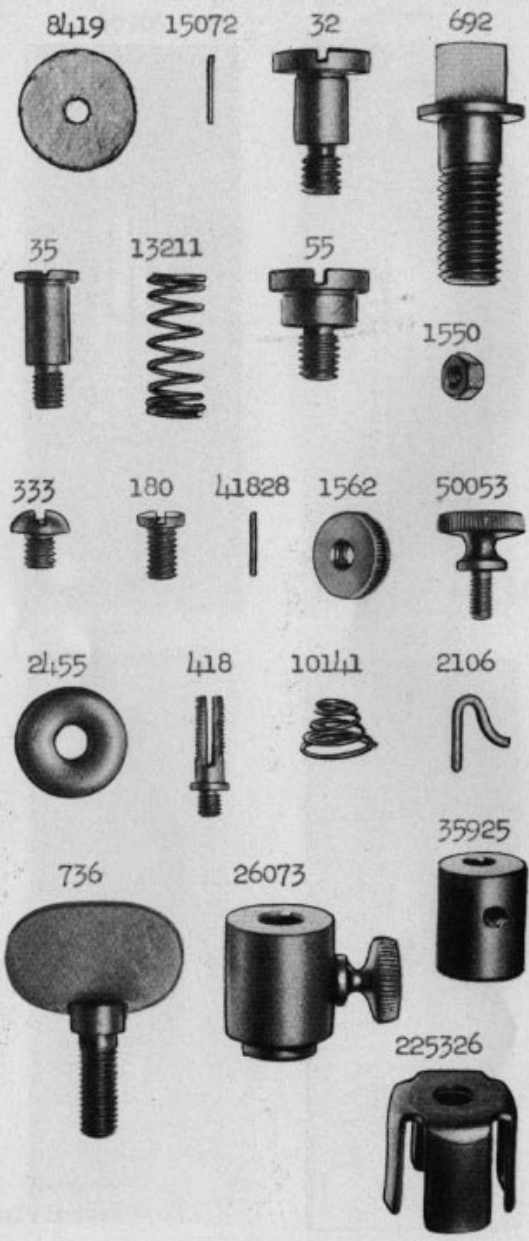


PLATE 8696-ONE-HALF SIZE

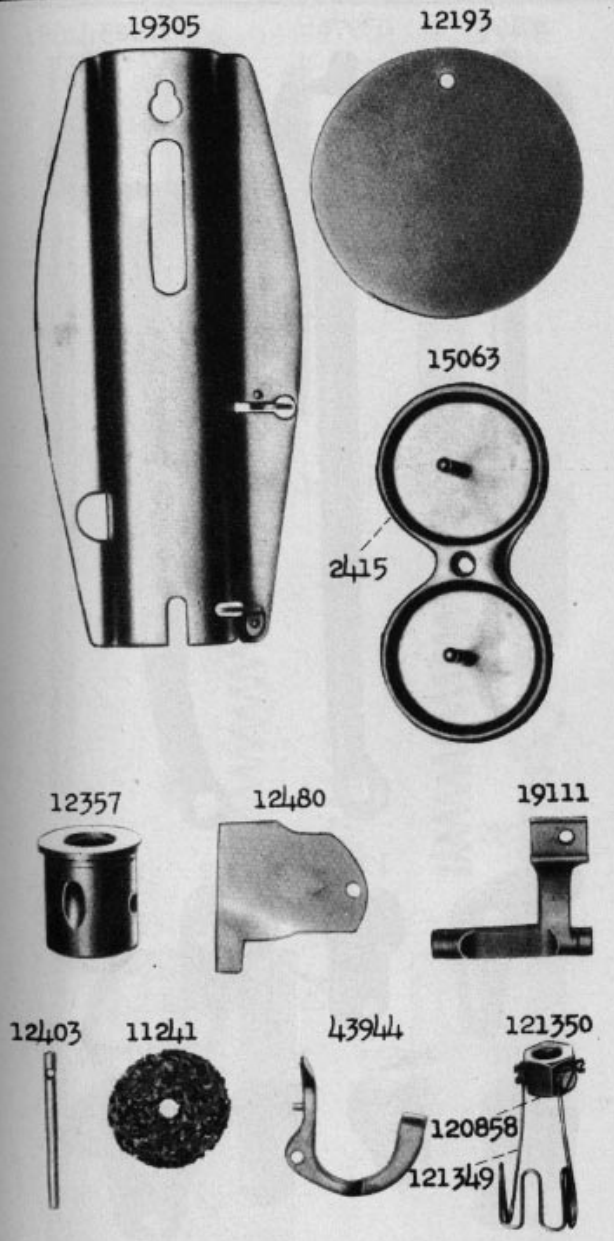
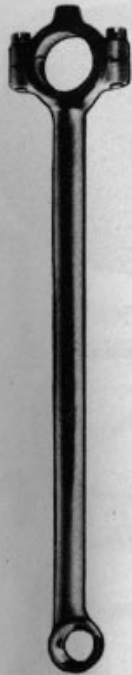
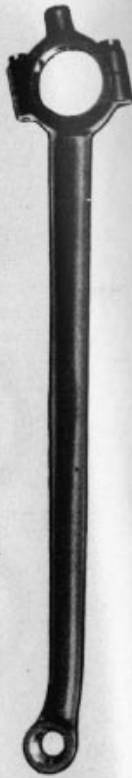


PLATE 8697-ONE-HALF SIZE

20197



43976



12123



3039



19120



24022



44224



24020

24021

12197



29633



16556



20188



PLATE 8698-ONE-HALF SIZE

18014



12391



12388



19386



19139



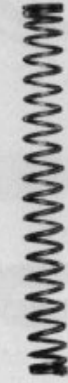
11167



12139



20023



688



52016



19319



19322



PLATE 8699-ONE-HALF SIZE

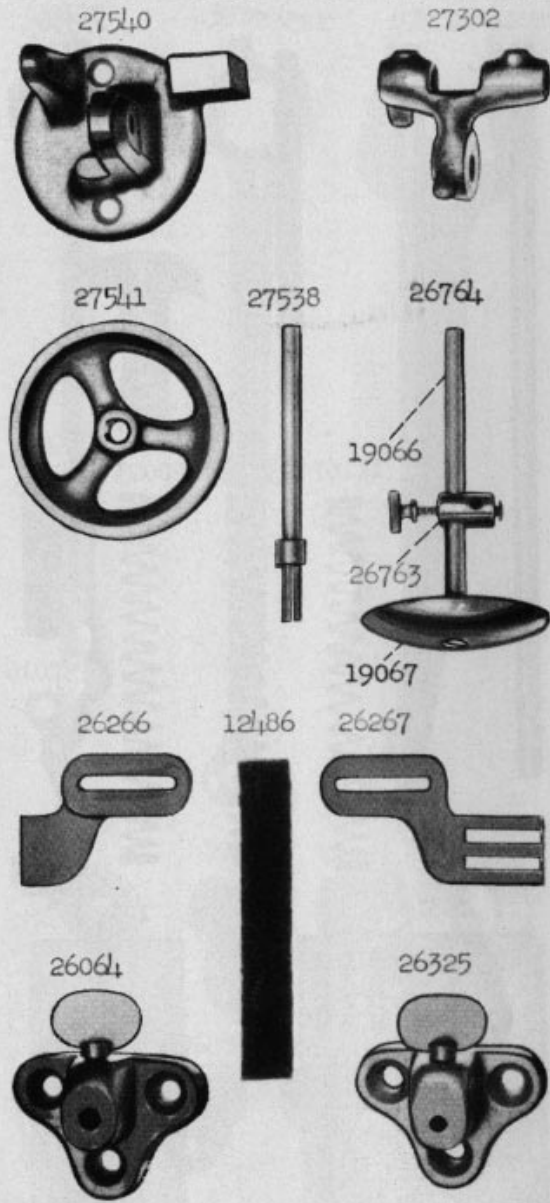


PLATE 8755-ONE-FOURTH SIZE

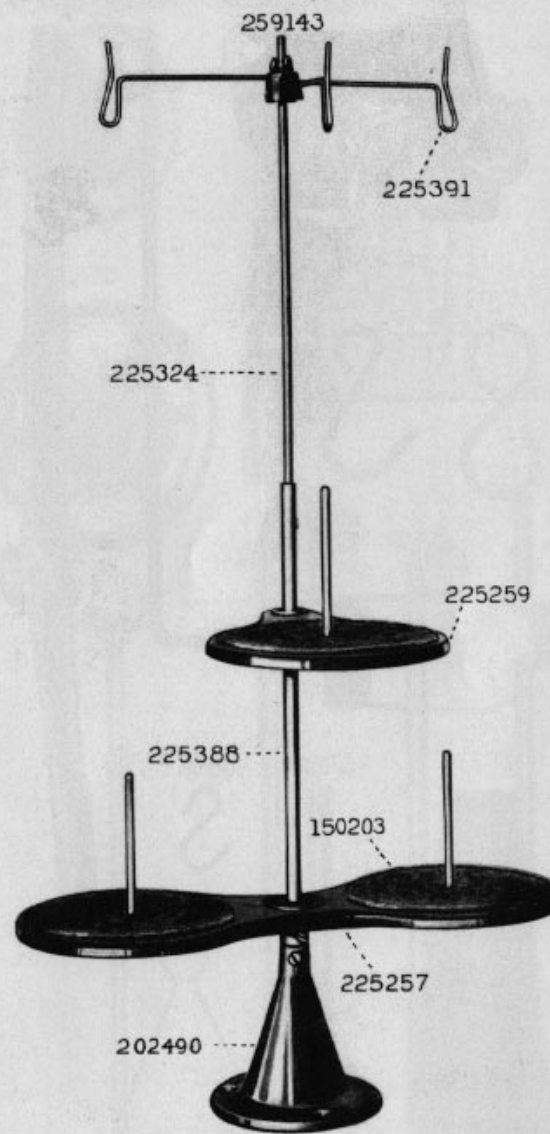


PLATE 22301-ONE-HALF SIZE

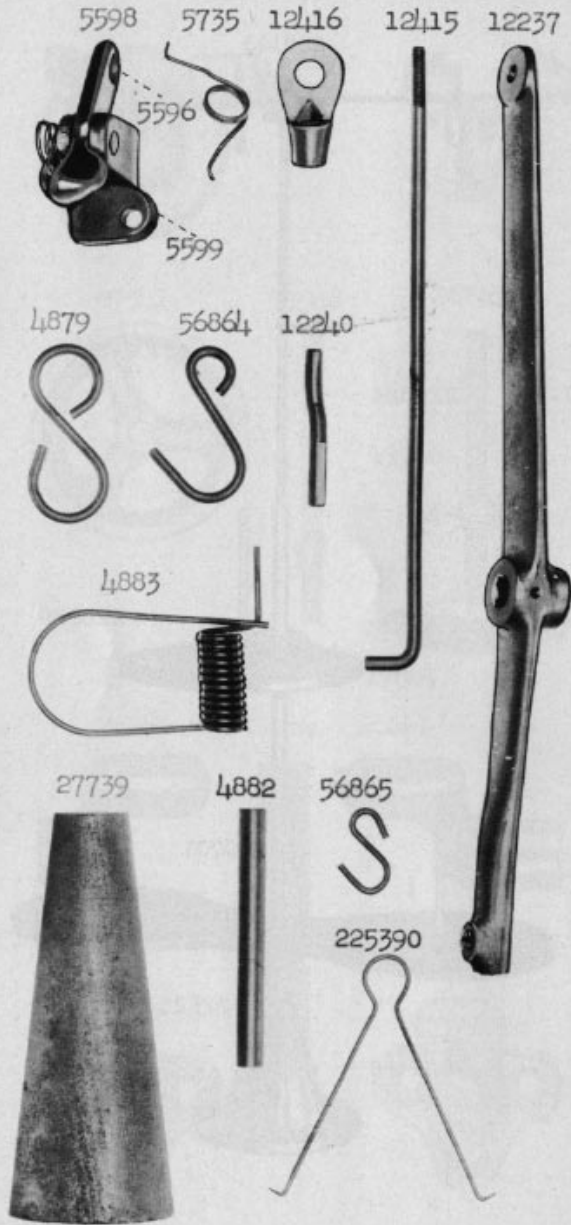


PLATE 22302-ONE-QUARTER SIZE

