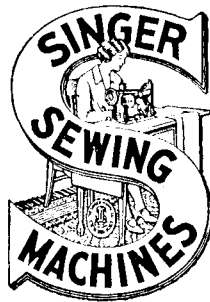


**SINGER**  
29W

# LIST OF PARTS



## MACHINES

Nos. 29w2, 29w6, 29w11, 29w14,  
29w15, 29w17, 29w21,  
29w23 and 29w27

## INDEX

---

	PAGE
ACCESSORIES .....	74
BOBBIN WINDER .....	74
FEED DOGS .....	77
"    WHEELS .....	77
KNEE LIFTER .....	75
KNIFE GRINDER .....	92
KNIVES .....	93
MACHINE No. 29w2 .....	7
"    "    29w6 .....	17
"    "    29w11 .....	27
"    "    29w14 .....	28
"    "    29w15 .....	38
"    "    29w17 .....	49
"    "    29w21 .....	60
"    "    29w23 .....	72
"    "    29w27 .....	73
NUMERICAL LIST OF PARTS .....	97
OBSOLETE PARTS .....	93
ROLLER PRESSERS .....	78
THROAT PLATES .....	79

# Instructions for Ordering

In ordering from this list, use **ONLY** the **PART** number in the **FIRST** column

The number stamped on a Sewing Machine Part is the number of the Single Part only, except when the part includes Set Screws, Clamping Screws, Studs and Rollers Spun on, Small Wires riveted, or Parts soldered together, etc., which it is necessary to furnish in combination.

Every combination of parts sent out has its specific number which, although not stamped on Parts (except in above cases) must be used when ordering the combination.

Each number always indicates the **SAME PART** in whatever list it appears, or for whatever Machine.

The letters after some of the numbers indicate the style of finish only, as follows:

- A. Hardened, Polished and Plated.
- B. Polished and Plated.
- C. Hardened only.
- D. Polished only.
- E. Soft, not polished.
- F. Hardened and Polished.
- H. Blued.

These letters **MUST BE USED** when they appear in the list and **AFTER** the number, as in the list.

### In this series

- 200001 to 201500 are Screw Numbers.
- 201501 to 201800 are Nut Numbers.
- 201801 to 202000 are Roller Numbers.
- 202001 and upward are numbers of Machine Parts.

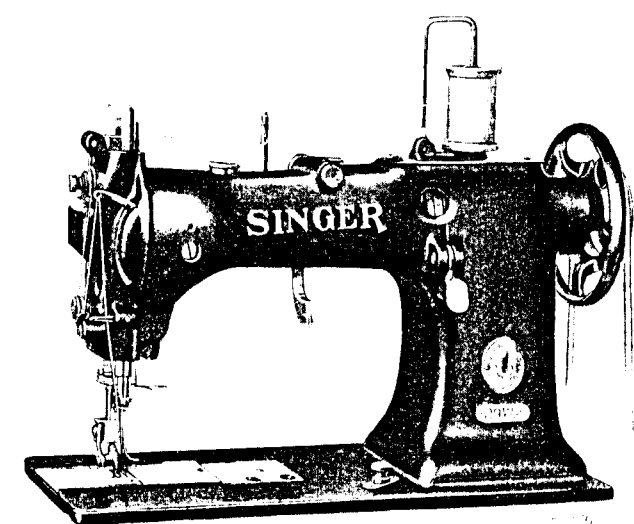
The figures in the second column refer only to the plate in which the illustration of the part is shown and are **NOT TO BE USED** in ordering.

Two or more numbers over a cut indicate that the difference between such parts is not visible in an illustration.

Parts marked with an asterisk (\*) are furnished only when repairs are made at the factory.

## LIST OF PARTS COMPLETE

FOR



### MACHINE No. 29w2

DROP FEED. VERTICAL SEAM TRIMMER

For Leather and Gloves

No.	Plate	Name
*213143	---	Arm .....
213921	11282	" Cap .....
200278H	12311	" " Screw .....
202248	11285	" " " Washer .....
203089	11282	" " Spool Holder Base .....
203090	11282	" " " " " 203089 with 200079H and 204296 .....
200585H	11285	Arm Cap Spool Holder Base Screw
204296	11282	" " " " Wire .....
200079H	12311	" " " " Hinge Screw .....
213922	---	Arm Cap and Spool Holder complete, Nos. 203090, 213921 and two 200585H .....
200010E	---	Arm Screw (3) .....
202005	11285	" " Washer (3) .....
213158	11281	" Shaft .....

No.	Plate	Name
223431	---	Arm Shaft 213158 with 200244d, 200245d, 213150, 213354, 213654, 213655, 223429, 223430 and two 201528e .....
204801	11282	Arm Shaft Bushing (back) with 202260 .....
202260	---	Arm Shaft Bushing (back) Oil Packing (wick) .....
200338c	11048	Arm Shaft Bushing (back) Set Screw .....
213299	11282	Arm Shaft Bushing (center) with 202260 .....
202260	---	Arm Shaft Bushing (center) Oil Packing (wick) .....
200338c	11048	Arm Shaft Bushing (center) Set Screw .....
204802	11282	Arm Shaft Bushing (front) with 202036 and 202260 .....
202260	---	Arm Shaft Bushing (front) Oil Packing (wick) .....
200502n	11285	Arm Shaft Bushing (front) Oil Packing Thumb Screw .....
202036	11285	Arm Shaft Bushing (front) Position Pin .....
200341c	11285	Arm Shaft Bushing (front) Set Screw .....
204804	11281	Arm Shaft Connection with four 200054e (2) .....
200054e	11285	Arm Shaft Connection Screw .....
213153	11281	Balance Wheel, 5 1/4 in. diam. (belt groove 2 3/4 in. diam.), with 200328c and 200335c .....
200062n	12311	Balance Wheel Adjusting Screw ..
200328c	12311	" " Position Screw .....
200335c	12311	" " Set Screw .....
*213652	---	Bed with 203248, 203249, two each 200362c, 200516e, 200840e and 202299 .....
202258	12153	Bed Hinge Connection (2) .....
200570e	12311	" " " Screw (4) .....
203329	11282	" Slide (back) .....
203207	11282	" " (front) .....
203208	11284	Bobbin .....
203210	11284	" Case Base with 202056, 203211 to 203213 and 203216 .....
203211	11284	Bobbin Case Base Latch .....
*202056	---	" " " " Pin .....
203212	11284	" " " " Plunger ..
203213	11284	" " " " Spring ...

No.	Plate	Name
203209	11284	Bobbin Case Cap with 200984c, 203214, 203215 and two 200594c..
203214	11284	Bobbin Case Tension Spring .....
200984c	11284	" " " " Regulat- ing Screw .....
200594c	11284	Bobbin Case Tension Spring Screw
203215	11284	" " Thread Guide .....
200594c	11284	" " " " Screw ..
203216	---	" " Washer (cloth) .....
203217	11284	Bobbin Case complete, Nos. 203209 and 203210 .....
223421	14102	Face Plate with 200366n, 200368n, 202087, 202090, 204185 and two 200397n .....
200065c	11285	Face Plate Screw (2) .....
204185	11292	" " Thread Guide .....
200397n	12349	" " " " Set Screw
223422	---	Face Plate complete, Nos. 200309e, 200577n, 202088, 204059, 204272, 204280, 223421 and 223423 .....
213146	11282	Feed Bar .....
213229	---	" " 213146 with 200641c, 201522e and 213147 .....
200641c	11048	Feed Bar Hinge Screw .....
201522e	11285	" " " " Nut .....
207651	14106	" Dog .....
200106e	12311	" " Screw (2) .....
223429	11298	" Driving Eccentric (adjustable)
223430	11298	" " " Adjusting Disc
213150	11282	" " " Flange with 200378c and 200437c .....
200437c	12311	Feed Driving Eccentric Flange Position Screw .....
200378c	12311	Feed Driving Eccentric Flange Set Screw .....
213655	11048	Feed Driving Eccentric Friction Spring Washer .....
200245d	11048	Feed Driving Eccentric Friction Spring Washer Screw .....
201528e	11285	Feed Driving Eccentric Friction Spring Washer Screw Nut .....
200244d	11048	Feed Driving Eccentric Fulcrum Screw .....
201528e	11285	Feed Driving Eccentric Fulcrum Screw Nut .....
213147	11281	Feed Driving Rock Shaft .....
202305	11285	" " " " Center (2)
200043c	12311	" " " " Set Screw (2) .....

No.	Plate	Name
213354	11281	Feed Driving Rock Shaft Connection with 200054E and 202277 ...
213654	11048	Feed Driving Rock Shaft Connection Collar .....
202298	11048	Feed Driving Rock Shaft Connection Crank with 200038c .....
200038c	11048	Feed Driving Rock Shaft Connection Crank Pinch Screw .....
200545c	11048	Feed Driving Rock Shaft Connection Hinge Screw .....
201518E	11285	Feed Driving Rock Shaft Connection Hinge Screw Nut .....
202277	---	Feed Driving Rock Shaft Connection Oil Packing (wick) .....
2009054E	11285	Feed Driving Rock Shaft Connection Pinch Screw .....
213627	11285	Feed Lifting Cam with 202126 ....
204202	11285	" " " Fork with 200027E
200027E	11285	" " " " Pinch Screw
202126	11285	" " " Position Pin ....
200045E	11285	" " " Screw .....
203236	11281	" " Rock Shaft .....
203316	11281	" " " " 203236 with 203238 .....
202305	11285	Feed Lifting Rock Shaft Center (2)
200043c	12311	" " " " " Set Screw (2) .....
202276	11285	Feed Lifting Rock Shaft Slide Block
203238	11285	" " " " " " 202276 with 200243E and 201531E
200243E	11285	Feed Lifting Rock Shaft Slide Block Hinge Screw .....
201531E	11285	Feed Lifting Rock Shaft Slide Block Hinge Screw Nut .....
213161	11048	Feed Regulating Lever with 213657
200665c	11048	" " " Hinge Screw
213656	14104	" " " Spring .....
213657	14104	" " " " Pin ..
*203463	---	Hook (sewing) .....
203464	11241	" 203463 with 201253F, 201376F and 203251 .....
203465	11241	Hook and Bobbin Case complete, Nos. 203217 and 203464 .....
203241	11007	Hook Bevel Gear Socket, 24 teeth
200555II	11007	" " " " Screw ...
203242	11007	" " Pinion, 24 teeth, with two 200383c .....
200383c	12311	Hook Bevel Pinion Set Screw ....
203243	11281	" Counter Shaft .....

No.	Plate	Name
203244	11007	Hook Counter Shaft Collar with two 200393c .....
200393c	11007	Hook Counter Shaft Collar Set Screw .....
203245	11007	Hook Counter Shaft Driving Gear, 44 teeth, with 200362c and 200439c
213155	---	Hook Counter Shaft Driving Gear 203245 with 200045E and 213627 ..
200439c	12311	Hook Counter Shaft Driving Gear Position Screw .....
200362c	12311	Hook Counter Shaft Driving Gear Set Screw .....
203246	11007	Hook Counter Shaft Gear, 22 teeth, with two 200383c .....
200383c	12311	Hook Counter Shaft Gear Set Screw
202299	---	" " " Oil Packing (wick) .....
200840E	11007	Hook Counter Shaft Oil Packing (wick) Stop Screw .....
203247	11281	Hook Driving Shaft .....
203248	11288	" " " Bearing with 202299 .....
202299	---	Hook Driving Shaft Bearing Oil Packing (wick) .....
202126	11285	Hook Driving Shaft Bearing Position Pin .....
200516E	12311	Hook Driving Shaft Bearing Screw
203249	11007	" " " Bushing (eccentric) .....
202299	---	Hook Driving Shaft Bushing Oil Packing (wick) .....
200362c	12311	Hook Driving Shaft Bushing Set Screw .....
213141	14107	Hook Driving Shaft Collar with two 200393c .....
200393c	11007	Hook Driving Shaft Collar Set Screw .....
203251	11284	Hook Gib .....
201376F	14104	" " Hinge Screw .....
201253F	14104	" " Screw .....
203252	11288	" Saddle with 202299 .....
202299	---	" " Oil Packing (wick) ....
200019E	11285	" " Screw (2) .....
202622	11285	" " " Washer (2) .....
203718	11241	" Washer .....
203466	11288	Hook Saddle complete, Nos. 200555II, 203241, 203252, 203465 and 203718 .....
228184	14108	Knee Lifter Connection Lever with 202446 .....

No.	Plate	Name
200224H	11285	Knee Lifter Connection Lever Hinge Screw .....
213879	14108	Knee Lifter Connection Lever Lifting Rod with 202302 .....
202302	14104	Knee Lifter Connection Lever Lifting Rod Cotter Pin .....
202446	14101	Knee Lifter Connection Lever Pin
228181	14102	" " Lifting Lever .....
228183	---	" " " " 228181 with 201178H, 201527H and 228182 .....
228182	14102	Knee Lifter Lifting Lever Bracket
200570E	12311	" " " " " " Screw .....
201178H	14103	Knee Lifter Lifting Lever Hinge Screw .....
201527H	14103	Knee Lifter Lifting Lever Hinge Screw Nut .....
207805	10620	Knife .....
202887	11289	" Bar .....
202888	11289	" " 202887 with 202894, 202895, two each 200585H and 200898D ..
221417	11290	Knife Bar Driving Eccentric with 200382C and 200437C .....
202890	11290	Knife Bar Driving Eccentric Fork with 200382C and 201464C .....
201464C	14103	Knife Bar Driving Eccentric Fork Position Screw .....
200382C	11285	Knife Bar Driving Eccentric Fork Set Screw .....
200437C	12311	Knife Bar Driving Eccentric Position Screw .....
200382C	11285	Knife Bar Driving Eccentric Set Screw .....
202891	11289	Knife Bar Driving Shaft Crank with 200694E and 201525E .....
200694E	11290	Knife Bar Driving Shaft Crank Screw Stud .....
201525E	11290	Knife Bar Driving Shaft Crank Screw Stud Nut .....
202893	11290	Knife Bar Lifting Spring (spiral) ..
202894	11290	" " " " Bracket ...
200585H	11285	" " " " " Screw
200485D	11290	" " " " " Thumb Screw .....
202895	14107	Knife Holder .....
200898D	14107	" " Screw .....
202897	14107	" " Switch-in Handle ....
200076D	11290	" Screw (2) .....
202898	11289	" Switch-out Handle with two 200403C .....

No.	Plate	Name
200403C	14103	Knife Switch-out Handle Set Screw
202899	11290	" " " Shaft ....
202900	11290	" " " Spring (spiral) .....
213770	11289	Needle Bar (hollow) with 200420E, 200595H and 213771 .....
207072	14104	Needle Bar Bushing (2) .....
200398C	14104	" " " Set Screw (2) ..
204248	11292	" " Connecting Link .....
200658C	11292	" " " " Hinge Screw Stud .....
201519C	14107	Needle Bar Connecting Link Hinge Screw Stud Nut .....
204249	11292	Needle Bar Connecting Stud with 200072C and 202277 .....
202277	---	Needle Bar Connecting Stud Oil Packing (wick) .....
200072C	11292	Needle Bar Connecting Stud Pinch Screw .....
213771	14107	Needle Bar Thread Guide .....
200595H	14103	" " " " Screw ..
200420E	14103	" Set Screw .....
207072	14104	Presser Bar Bushing .....
200398C	14104	" " " Set Screw ....
202339	14104	" " Lifter .....
200653C	14104	" " " Hinge Screw ...
204455	11287	" " Lifting Bracket with 200387C .....
213667	14104	Presser Bar Lifting Bracket Position Guide with 200075D and 203551 .....
200075D	11292	Presser Bar Lifting Bracket Position Guide Screw .....
203551	11292	Presser Bar Lifting Bracket Position Guide Screw Bushing .....
200362C	12311	Presser Bar Lifting Bracket Position Guide Set Screw .....
200387C	10473	Presser Bar Lifting Bracket Set Screw .....
204258	11292	Presser Bar Spring (heavy) .....
200494B	14104	" " Thumb Screw (pressure regulating) .....
201910	11293	Roller Presser, $\frac{3}{8}$ in. diam., $\frac{1}{4}$ in. face (coarse) with 200551C and 201534H .....
208497	---	Roller Presser Arm .....
208498	---	" " " 208497 with 201910 .....

No.	Plate	Name
202560	11293	Roller Presser Arm Bracket (swing)
208499	---	" " " " 202560 with 200096D and 208498 .....
200675F	11293	Roller Presser Arm Bracket Position Screw Stud .....
202558	11293	Roller Presser Arm Bracket Spring
202559	11293	" " " " " " Stop .....
200141F	11293	Roller Presser Arm Bracket Spring Stop Screw .....
200096D	11293	Roller Presser Arm Screw .....
204495	11289	" " Bar .....
200551C	11293	" " Hinge Screw .....
201534H	11293	" " " " Nut .....
204576	---	Roller Presser and Bar complete, Nos. 200675F, 202558, 202559, 204495, 208499 and two 200141F..
213006	11288	Take-up Cam with 200335C, 200383C, 200430C, 200658C and 201519E ...
203172	11292	Take-up Cam Friction Washer .....
200430C	12311	" " Position Screw .....
200383C	12311	" " " " Check Screw .....
200335C	12311	Take-up Cam Set Screw .....
203270	11292	" Lever .....
203291	---	" " 203270 with 204263 ...
204263	11292	" " Bearing with 204264 ..
204264	11292	" " " Position Pin ...
200042F	12311	" " " Screw .....
201816	11292	" " Roller .....
203271	11292	Take-up Lever complete, Nos. 200042F, 201816 and 203291 .....
244007	12349	Tension Disc .....
202090	12349	" " Position Pin .....
223423	14107	" Release Lever .....
200309E	12349	" " " Screw .....
202075	12349	" " Plunger .....
223427	14107	" " Slide .....
204457	14104	" " " Spring .....
202737	14101	" " " " Adjusting Collar with 200380C .....
200380C	14107	Tension Release Slide Spring Adjusting Collar Set Screw .....
202407	10881	Tension Spring .....
200632B	12349	" Stud .....
200397H	12349	" " Set Screw .....
201572B	10881	" Thumb Nut .....
204271	12349	" Washer .....

No.	Plate	Name
204272	12349	Tension complete, Nos. 200632B, 201572B, 202075, 202407, 204271 and two 244007 .....
204274	12349	Thread Controller Plate .....
200577H	10473	" " " Screw .....
202098	12349	" " Roller .....
204275	12349	" " " Guard .....
202084	12349	" " " " Washer..
200300C	12349	" " " Screw .....
204276	12349	" " Spring .....
204333	12349	" " " Guard .....
200581H	12349	" " " " Screw ..
202087	12349	" " " Stop .....
202088	12349	" " " Stud with 204925 .....
200366H	12349	Thread Controller Spring Stud Set Screw .....
204925	11292	Thread Controller Spring Stud Washer .....
205987	12349	Thread Controller complete, Nos. 200300C, 200581H, 202084, 202098, 204274, 204275 and 204333 .....
204280	12349	Thread Controller and Spring complete, Nos. 204276 and 205987 ..
202412	11292	Thread Guide .....
202413	11292	" " .....
202091	12349	" Retainer Sleeve .....
202092	12349	" " Spring .....
204058	12349	" " Stud .....
200368H	12349	" " " Set Screw .....
204059	12349	Thread Retainer complete, Nos. 202091, 202092 and 204058 .....
211452	12058	Throat Plate, 56 needle hole, for needle sizes 10 and 11, with 200178B, 200587D, 211416 and 211424, trims opposite the needle and .035, .045, .060 and .085 in. to right of seam .....
213163	14102	Throat Plate Adjusting Lever with 200627E, 201539E, 204387 and two two 200479E .....
200264D	11052	Throat Plate Adjusting Lever Hinge Screw .....
200479E	11052	Throat Plate Adjusting Lever Position Screw .....
200627E	11052	Throat Plate Adjusting Lever Screw Stud .....
201539E	11052	Throat Plate Adjusting Lever Screw Stud Nut .....

No.	Plate	Name
201556D	14103	Throat Plate Adjusting Lever Screw Stud Thumb Nut .....
213112	14101	Throat Plate Adjusting Lever Screw Stud Thumb Nut Washer Plate .....
203152	14103	Throat Plate Adjusting Lever Screw Stud Thumb Nut Washer Plate Pin (2) .....
211424	12024	Throat Plate Knife Follower .....
200587D	14103	" " " " Screw ..
211416	14106	" " " " Spring
200178D	14103	" " " " " " Screw .....
200585H	11285	Throat Plate Screw (2) .....
213162	14102	" " Slide Plate (adjust- able) .....
204387	14101	Throat Plate Slide Plate Position Stud .....
200306D	11052	Throat Plate Slide Plate Screw (2)

## LIST OF PARTS COMPLETE

FOR

## MACHINE No. 29w6

DROP FEED. VERTICAL SEAM TRIMMER

For Leather and Gloves

No.	Plate	Name
*213143	- - -	Arm .....
213921	11282	" Cap .....
200278H	12311	" " Screw .....
202248	11285	" " " Washer .....
203089	11282	" " Spool Holder Base .....
203090	11282	" " " " " " 203089 with 200079H and 204296 .....
200585H	11285	Arm Cap Spool Holder Base Screw
204296	11282	" " " " Wire .....
200079H	12311	" " " " " Hinge Screw .....
213922	- - -	Arm Cap and Spool Holder com- plete, Nos. 203090, 213921 and two 200585H .....
200010E	- - -	Arm Screw (3) .....
202005	11285	" " Washer (3) .....
213158	11281	" Shaft .....
223431	-----	" " 213158 with 200244D, 200245D, 213150, 213354, 213654, 213655, 223429, 223430 and two 201528E .....
204801	11282	Arm Shaft Bushing (back) with 202260 .....
202260	-----	Arm Shaft Bushing (back) Oil Packing (wick) .....
200338C	11048	Arm Shaft Bushing (back) Set Screw .....
213299	11282	Arm Shaft Bushing (center) with 202260 .....
202260	-----	Arm Shaft Bushing (center) Oil Packing (wick) .....
200338C	11048	Arm Shaft Bushing (center) Set Screw .....
204802	11282	Arm Shaft Bushing (front) with 202036 and 202260 .....
202260	-----	Arm Shaft Bushing (front) Oil Packing (wick) .....



No.	Plate	Name
200502B	11285	Arm Shaft Bushing (front) Oil Packing Thumb Screw .....
202036	11285	Arm Shaft Bushing (front) Position Pin .....
200341c	11285	Arm Shaft Bushing (front) Set Screw .....
204804	11281	Arm Shaft Connection with four 200054E (2) .....
200054E	11285	Arm Shaft Connection Screw .....
213153	11281	Balance Wheel, 5 1/4 in. diam. (belt groove 2 3/4 in. diam.), with 200328c and 200335c .....
200062H	12311	Balance Wheel Adjusting Screw ..
200328c	12311	" " Position Screw ....
200335c	12311	" " Set Screw .....
*213652	---	Bed with 203248, 203249, two each 200362c, 200516E, 200840E and 202299 .....
202258	12153	Bed Hinge Connection (2) .....
200570E	12311	" " " Screw (4) ....
203329	11282	" Slide (back) .....
203207	11282	" " (front) .....
203470	11284	Bobbin .....
*203670	---	" Case .....
203648	11284	" " Latch .....
*202056	---	" " " Pin .....
203473	11284	" " " Plunger .....
203474	11284	" " " Spring .....
203499	11287	" " " Lever .....
*203476	---	" " " Eccentric .....
204243	11284	" " " " Position Pin .....
203506	11287	" " " Fulcrum .....
200056E	10884	" " " " Screw ....
203478	11284	" " " Slide Stud .....
203214	11284	" " Tension Spring .....
200984c	11284	" " " " Regulat- ing Screw .....
200594c	11284	Bobbin Case Tension Spring Screw
203216	---	" " Washer (cloth) ....
203669	11284	Bobbin Case complete, Nos. 200594c, 200984c, 202056, 203214, 203216, 203473, 203474, 203648 and 203670
223421	14102	Face Plate with 200366H, 200368H, 202087, 202090, 204185 and two 200397H .....
200065c	11285	Face Plate Screw (2) .....
204185	11292	" " Thread Guide .....
200397H	12349	" " " " Set Screw

No.	Plate	Name
223422	---	Face Plate complete, Nos. 200309E, 200577H, 202088, 204059, 204272, 204280, 223421 and 223423 .....
213146	11282	Feed Bar .....
213229	---	" " 213146 with 200641c, 201522E and 213147 .....
200641c	11048	Feed Bar Hinge Screw .....
201522E	11285	" " " " Nut .....
207651	14106	" Dog .....
200106E	12311	" " Screw (2) .....
223429	11298	" Driving Eccentric (adjustable)
223430	11298	" " " Adjusting Disc
213150	11282	" " " Flange with 200378c and 200437c .....
200437c	12311	Feed Driving Eccentric Flange Position Screw .....
200378c	12311	Feed Driving Eccentric Flange Set Screw .....
213655	11052	Feed Driving Eccentric Friction Spring Washer .....
200245D	11048	Feed Driving Eccentric Friction Spring Washer Screw .....
201528E	11285	Feed Driving Eccentric Friction Spring Washer Screw Nut .....
200244D	11048	Feed Driving Eccentric Fulcrum Screw .....
201528E	11285	Feed Driving Eccentric Fulcrum Screw Nut .....
213147	11281	Feed Driving Rock Shaft .....
202305	11285	" " " " Center (2)
200043c	12311	" " " " " Set Screw (2) .....
213354	11281	Feed Driving Rock Shaft Connection with 200054E and 202277 ....
213654	11048	Feed Driving Rock Shaft Connection Collar .....
202298	11048	Feed Driving Rock Shaft Connection Crank with 200038c .....
200038c	11048	Feed Driving Rock Shaft Connection Crank Pinch Screw .....
200545c	11048	Feed Driving Rock Shaft Connection Hinge Screw .....
201518E	11284	Feed Driving Rock Shaft Connection Hinge Screw Nut .....
202277	---	Feed Driving Rock Shaft Connection Oil Packing (wick) .....
200054E	11285	Feed Driving Rock Shaft Connection Pinch Screw .....

No.	Plate	Name
213627	11285	Feed Lifting Cam with 202126 ....
204202	11285	" " " Fork with 200027E
200027E	11285	" " " " Pinch Screw
202126	11285	" " " Position Pin ....
200045E	11285	" " " Screw .....
203236	11281	" " Rock Shaft .....
203316	11281	" " " 203236 with 203238 .....
202305	11285	Feed Lifting Rock Shaft Center (2)
200043C	12311	" " " " " Set Screw (2) .....
202276	11285	Feed Lifting Rock Shaft Slide Block
203238	11285	" " " " " " " 202276 with 200243E and 201531E
200243E	11285	Feed Lifting Rock Shaft Slide Block Hinge Screw .....
201531E	11285	Feed Lifting Rock Shaft Slide Block Hinge Screw Nut .....
213161	11048	Feed Regulating Lever with 213657
200665C	11048	" " " Hinge Screw
213656	14104	" " " Spring .....
213657	14104	" " " " Pin ..
*203482	-----	Hook (sewing) .....
203483	11287	" 203482 with 201253E, 201376E and 203251 .....
203671	11287	Hook and Bobbin Case complete, Nos. 203483 and 203669 .....
213810	11287	Hook Bevel Gear Socket, 24 teeth
200555H	11007	" " " " Screw ...
203242	11007	" " Pinion, 24 teeth, with two 200383C .....
200383C	12311	Hook Bevel Pinion Set Screw ....
203243	11281	" Counter Shaft .....
203244	11907	" " " Collar with two 200393C .....
200393C	11007	Hook Counter Shaft Collar Set Screw .....
203245	11007	Hook Counter Shaft Driving Gear, 44 teeth, with 200362C and 200439C
213155	-----	Hook Counter Shaft Driving Gear 203245 with 200045E and 213627..
200439C	12311	Hook Counter Shaft Driving Gear Position Screw .....
200362C	12311	Hook Counter Shaft Driving Gear Set Screw .....
203246	11007	Hook Counter Shaft Gear, 22 teeth, with two 200383C .....
200383C	12311	Hook Counter Shaft Gear Set Screw .....

No.	Plate	Name
202299	-----	Hook Counter Shaft Oil Packing (wick) .....
200840E	11907	Hook Counter Shaft Oil Packing (wick) Stop Screw .....
203247	11281	Hook Driving Shaft .....
203248	11288	" " " Bearing with 202299 .....
202299	---	Hook Driving Shaft Bearing Oil Packing (wick) .....
202126	11285	Hook Driving Shaft Bearing Posi- tion Pin .....
200516E	12311	Hook Driving Shaft Bearing Screw
203249	11907	" " " Bushing (eccen- tric) .....
202299	---	Hook Driving Shaft Bushing Oil Packing (wick) .....
200362C	12311	Hook Driving Shaft Bushing Set Screw .....
213141	14107	Hook Driving Shaft Collar with two 200393C .....
200393C	11007	Hook Driving Shaft Collar Set Screw .....
203251	11284	Hook Gib .....
201376E	14104	" " Hinge Screw .....
201253E	14104	" " Screw .....
203504	11288	" Saddle with 200056E .....
200006E	11007	" " Screw (2) .....
225585	11007	" " " Washer (2) .....
213018	14107	" Washer with 203476 and two 204243 .....
203680	11288	Hook Saddle complete, Nos. 200555H, 203478, 203499, 203504, 203506, 203761, 213018 and 213810 .....
228184	14108	Knee Lifter Connection Lever with 202446 .....
200224H	11285	Knee Lifter Connection Lever Hinge Screw .....
213879	14108	Knee Lifter Connection Lever Lift- ing Rod with 202302 .....
202302	14104	Knee Lifter Connection Lever Lift- ing Rod Cotter Pin .....
202446	14101	Knee Lifter Connection Lever Pin
228181	14102	" " Lifting Lever .....
228183	---	" " " " 228181 with 201178H, 201527H and 228182 ....
228182	14102	Knee Lifter Lifting Lever Bracket
200570E	12311	" " " " " Screw .....
201178H	14103	Knee Lifter Lifting Lever Hinge Screw .....

No.	Plate	Name
201527H	14103	Knee Lifter Lifting Lever Hinge Screw Nut .....
207805	10620	Knife .....
202887	11289	" Bar .....
202888	11289	" " 202887 with 202894, 202895, two each 200585H and 200898D ..
221417	11290	Knife Bar Driving Eccentric with 200382c and 200437c .....
202890	11290	Knife Bar Driving Eccentric Fork with 200382c and 201464c .....
201464c	14104	Knife Bar Driving Eccentric Fork Position Screw .....
200382c	11285	Knife Bar Driving Eccentric Fork Set Screw .....
200437c	12311	Knife Bar Driving Eccentric Position Screw .....
200382c	11285	Knife Bar Driving Eccentric Set Screw .....
202891	11289	Knife Bar Driving Shaft Crank with 200694F and 201525E .....
200694F	11290	Knife Bar Driving Shaft Crank Screw Stud .....
201525E	11290	Knife Bar Driving Shaft Crank Screw Stud Nut .....
202893	11290	Knife Bar Lifting Spring (spiral) ..
202894	11290	" " " " Bracket ..
200585H	11285	" " " " " Screw .....
200485D	11290	Knife Bar Lifting Spring Thumb Screw .....
202895	14107	Knife Holder .....
200898D	14107	" " Screw .....
202897	14107	" " Switch-in Handle .....
200076D	11290	" Screw (2) .....
202898	11289	" Switch-out Handle with two 200403c .....
200403c	14103	Knife Switch-out Handle Set Screw .....
202899	11290	" " " Shaft .....
202900	11290	" " " Spring (Spiral) .....
213770	11289	Needle Bar (hollow) with 200420F, 200595H and 213771 .....
207072	14104	Needle Bar Bushing (2) .....
200398c	14104	" " " Set Screw (2) ..
204248	11292	" " Connecting Link .....
200658c	11292	" " " " Hinge Screw Stud .....
201519E	14107	Needle Bar Connecting Link Hinge Screw Stud Nut .....

No.	Plate	Name
204249	11292	Needle Bar Connecting Stud with 200072c and 202277 .....
202277	-----	Needle Bar Connecting Stud Oil Packing (wick) .....
200072c	11292	Needle Bar Connecting Stud Pinch Screw .....
213771	14107	Needle Bar Thread Guide .....
200595H	14103	" " " " Screw ..
200420F	14103	" Set Screw .....
207072	14104	Presser Bar Bushing .....
200398c	14104	" " " Set Screw .....
202339	14104	" " Lifter .....
200653c	14104	" " " Hinge Screw .....
204455	11287	" " Lifting Bracket with 200387c .....
213667	14104	Presser Bar Lifting Bracket Position Guide with 200075D and 203551 .....
200075D	11292	Presser Bar Lifting Bracket Position Guide Screw .....
203551	11292	Presser Bar Lifting Bracket Position Guide Screw Bushing .....
200362c	12311	Presser Bar Lifting Bracket Position Guide Set Screw .....
200387c	10473	Presser Bar Lifting Bracket Set Screw .....
204258	11292	Presser Bar Spring (heavy) .....
200494B	14104	" " Thumb Screw (pressure regulating) .....
201910	11293	Roller Presser, $\frac{3}{8}$ in. diam., $\frac{1}{4}$ in. face (coarse), with 200551c and 201534H .....
208497	-----	Roller Presser Arm .....
208498	11293	" " " 208497 with 201910 .....
202560	11293	Roller Presser Arm Bracket (swing) .....
208499	-----	" " " " 202560 with 200096D and 208498 .....
200675F	11293	Roller Presser Arm Bracket Position Screw Stud .....
202558	11293	Roller Presser Arm Bracket Spring .....
202559	11293	" " " " " Stop .....
200141F	11293	Roller Presser Arm Bracket Spring Stop Screw .....
200096D	11293	Roller Presser Arm Screw .....
204495	11289	" " Bar .....
200551c	11293	" " Hinge Screw .....
201534H	11293	" " " " Nut .....

No.	Plate	Name
204576	—	Roller Presser and Bar complete, Nos. 200675F, 202558, 202559, 204495, 208499 and two 200141F ..
213006	11288	Take-up Cam with 200335c, 200383c, 200430c, 200658c and 201519E ..
203172	11292	Take-up Cam Friction Washer .....
200430c	12311	" " Position Screw .....
200383c	12311	" " " " Check Screw .....
200335c	12311	Take-up Cam Set Screw .....
203270	11292	" Lever .....
203291	—	" " 203270 with 204263 ..
204263	11292	" " Bearing with 204264 ..
204264	11292	" " " Position Pin ...
200042F	12311	" " " Screw .....
201816	11292	" " Roller .....
203271	11292	Take-up Lever complete, Nos. 200042F, 201816 and 203291 .....
244007	12349	Tension Disc .....
202090	12349	" " Position Pin .....
223423	14107	" Release Lever .....
200309E	12349	" " " Screw .....
202075	12349	" " Plunger .....
223427	14107	" " Slide .....
204457	14101	" " " Spring .....
202737	14101	" " " " Adjusting Collar with 200380c .....
200380c	14107	Tension Release Slide Spring Adjusting Collar Set Screw .....
202407	10881	Tension Spring .....
200632B	12349	" Stud .....
200397H	12349	" " Set Screw .....
201572B	10881	" Thumb Nut .....
204271	12349	" Washer .....
204272	12349	Tension complete, Nos. 200632B, 201572B, 202075, 202407, 204271 and two 244007 .....
204274	12349	Thread Controller Plate .....
200577H	10473	" " " Screw .....
202098	12349	" " Roller .....
204275	12349	" " " Guard .....
202084	12349	" " " Washer .....
200300c	12349	" " " Screw .....
204276	12349	" " Spring .....
204333	12349	" " Guard .....
200581H	12349	" " " " Screw .....
202087	12349	" " " Stop .....
202088	12349	" " " Stud with 204925 .....

No.	Plate	Name
200366H	12349	Thread Controller Spring Stud Set Screw .....
204925	11292	Thread Controller Spring Stud Washer .....
205987	12349	Thread Controller complete, Nos. 200300c, 200581H, 202084, 202098, 204274, 204275 and 204333 .....
204280	12349	Thread Controller and Spring complete, Nos. 204276 and 205987 ..
202412	11292	Thread Guide .....
202413	11292	" " .....
202091	12349	" Retainer Sleeve .....
202092	12349	" " Spring .....
204058	12349	" " Stud .....
200368H	12349	" " " Set Screw .....
204059	12349	Thread Retainer complete, Nos. 202091, 202092 and 204058 .....
211420	12064	Throat Plate, 56 needle hole, for needle sizes 10 and 11, with 200178D, 200587D, 211416 and 211424, trims opposite the needle and .035, .045, .060 and .085 in. to right of seam .....
213163	14102	Throat Plate Adjusting Lever with 200627E, 201539E, 204387 and two 200479F .....
200264D	11052	Throat Plate Adjusting Lever Hinge Screw .....
200479F	11052	Throat Plate Adjusting Lever Position Screw .....
200627E	11052	Throat Plate Adjusting Lever Screw Stud .....
201539E	11052	Throat Plate Adjusting Lever Screw Stud Nut .....
201556D	14103	Throat Plate Adjusting Lever Screw Stud Thumb Nut .....
213112	14101	Throat Plate Adjusting Lever Screw Stud Thumb Nut Washer Plate .....
203152	14103	Throat Plate Adjusting Lever Screw Stud Thumb Nut Washer Plate Pin (2) .....
211424	12024	Throat Plate Knife Follower .....
200587D	14103	" " " " Screw .....
211416	14106	" " " " Spring .....
200178D	14103	" " " " " Screw .....

No.	Plate	Name
200585R	11285	Throat Plate Screw (2) .....
213162	14102	" " Slide Plate (adjust- able) .....
204387	14101	Throat Plate Slide Plate Position Stud .....
200306D	11052	Throat Plate Slide Plate Screw (2)

## MACHINE No. 29w11

Same as Machine No. 29w2 with the following exceptions:

No.	Plate	Name
223440	----	Face Plate complete, Nos. 200309E, 200577U, 202088, 204059, 204280, 223421, 223423 and 223439, in place of 223422 .....
213007	14101	Feed Lifting Cam with 202126, in place of 213627 .....
*223434	----	Hook (sewing), in place of 203463
223435	14101	" 223434 with 201253F, 201376E and 203251, in place of 203464 ..
223436	----	Hook and Bobbin Case complete, Nos. 203217 and 223435, in place of 203465 .....
213157	----	Hook Counter Shaft Driving Gear 203245 with 200045E and 213007, in place of 213155 .....
223437	14102	Hook Saddle complete, Nos. 200555U, 203241, 203252, 203718 and 223436, in place of 203466 ..
202554	14101	Presser Bar Lifter, in place of 202339 .....
201907	11293	Roller Presser, 1½ in. diam., ½ in. face (fine), with 200548C and 201534U, in place of 201910 .....
202839	11293	Roller Presser Arm, in place of 204328 .....
204569	11293	Roller Presser Arm 202839 with 201907, in place of 204570 .....
204436	----	Roller Presser Arm Bracket 202560 with 200096D and 204569, in place of 204575 .....
204437	----	Roller Presser and Bar complete, Nos. 200675C, 202558, 202559, 204436, 204495 and two 200141F, in place of 204576 .....
223438	14101	Tension Spring, in place of 202407
223439	14107	Tension complete, Nos. 200632B, 201572B, 202075, 204271, 223438 and two 202402, in place of 204272
211454	12058	Throat Plate, 50 needle hole, for needle sizes 14 and 15, with 200178D, 200587D, 211416 and 211424, trims opposite the needle .060 and .085 in. to right of seam, in place of 211452 .....

## LIST OF PARTS COMPLETE

FOR

## MACHINE No. 29w14

WHEEL FEED. VERTICAL SEAM TRIMMER

For Leather and Gloves

No.	Plate	Name
*213143	---	Arm .....
213921	11282	" Cap .....
200278u	12311	" " Screw .....
202248	11285	" " " Washer .....
203089	11282	" " Spool Holder Base .....
203090	11282	" " " " " 203089 with 200079u and 204296 .....
200585u	11285	Arm Cap Spool Holder Base Screw
204296	11282	" " " " Wire .....
200079u	12311	" " " " " Hinge Screw .....
213922	---	Arm Cap Spool Holder complete, Nos. 203090, 213921 and two 200585u .....
200010E	---	Arm Screw (3) .....
202005	11285	" " Washer (3) .....
213158	11281	" Shaft .....
223431	---	" " 213158 with 200244d, 200245d, 213150, 213354, 213654, 213655, 223429, 223430 and two 201528E .....
204801	11282	Arm Shaft Bushing (back) with 202260 .....
202260	---	Arm Shaft Bushing (back) Oil Packing (wick) .....
200338c	11048	Arm Shaft Bushing (back) Set Screw .....
213299	11282	Arm Shaft Bushing (center) with 202260 .....
202260	---	Arm Shaft Bushing (center) Oil Packing (wick) .....
200338c	11048	Arm Shaft Bushing (center) Set Screw .....
204802	11282	Arm Shaft Bushing (front) with 202036 and 202260 .....
202260	---	Arm Shaft Bushing (front) Oil Packing (wick) .....

No.	Plate	Name
200502b	11285	Arm Shaft Bushing (front) Oil Packing Thumb Screw .....
202036	11285	Arm Shaft Bushing (front) Posi- tion Pin .....
200341c	11285	Arm Shaft Bushing (front) Set Screw .....
204804	11281	Arm Shaft Connection with four 200054E (2) .....
200054E	11285	Arm Shaft Connection Screw .....
213153	11281	Balance Wheel, 5 $\frac{1}{4}$ in. diam. (belt groove 2 $\frac{3}{4}$ in. diam.), with 200328c and 200335c .....
200062u	12311	Balance Wheel Adjusting Screw ..
200328c	12311	" " Position Screw .....
200335c	12311	" " Set Screw .....
*213868	---	Bed with 203248, 203249, two each 200362c, 200516E, 200840E and 202299 .....
202258	12153	Bed Hinge Connection (2) .....
200570E	12311	" " " Screw (4) .....
203329	11282	" Slide (back) .....
203207	11282	" " (front) .....
203470	11284	Bobbin .....
*203670	---	" Case .....
203648	11284	" " Latch .....
*202056	---	" " " Pin .....
203473	11284	" " " Plunger .....
203474	11284	" " " Spring .....
203499	11287	" " Lever .....
*203476	---	" " " Eccentric .....
204243	11284	" " " Position Pin .....
203506	11287	" " " Fulcrum .....
200056E	10884	" " " " Screw .....
203478	11284	" " " Slide Stud .....
203214	11284	" " Tension Spring .....
200984c	11284	" " " " Regulat- ing Screw .....
200594c	11284	Bobbin Case Tension Spring Screw
203216	---	" " Washer (cloth) .....
203669	11284	Bobbin Case complete. Nos. 200594c, 200984c, 202056, 203214, 203216, 203473, 203474, 203648 and 203670
223421	---	Face Plate with 200366u, 200368u, 202087, 202090, 204185 and two 200397u .....
200065c	11285	Face Plate Screw (2) .....
204185	11292	" " Thread Guide .....
200397u	12349	" " " " Set Screw

No.	Plate	Name
223422	—	Face Plate complete, Nos. 200309E, 200577H, 202088, 204059, 204272, 204280, 223421 and 223423 .....
223429	11298	Feed Driving Eccentric (adjustable)
223430	11298	" " " Adjusting Disc
213150	11282	" " " Flange with 200378c and 200437c .....
200437c	12311	Feed Driving Eccentric Flange Position Screw .....
200378c	12311	Feed Driving Eccentric Flange Set Screw .....
213655	11048	Feed Driving Eccentric Friction Spring Washer .....
200245D	11048	Feed Driving Eccentric Friction Spring Washer Screw .....
201528E	11285	Feed Driving Eccentric Friction Spring Washer Screw Nut .....
200244D	11048	Feed Driving Eccentric Fulcrum Screw .....
201528E	11285	Feed Driving Eccentric Fulcrum Screw Nut .....
213863	11281	Feed Driving Rock Shaft .....
202305	11285	" " " " Center (2)
200043c	12311	" " " " " Set Screw (2) .....
213354	11281	Feed Driving Rock Shaft Connection with 200054E and 202277 ..
213654	11048	Feed Driving Rock Shaft Connection Collar .....
202298	11048	Feed Driving Rock Shaft Connection Crank with 200038c .....
200038c	11048	Feed Driving Rock Shaft Connection Crank Pinch Screw .....
200545c	11048	Feed Driving Rock Shaft Connection Hinge Screw .....
201518E	11285	Feed Driving Rock Shaft Connection Hinge Screw Nut .....
202277	—	Feed Driving Rock Shaft Connection Oil Packing (wick) .....
200054E	11285	Feed Driving Rock Shaft Connection Pinch Screw .....
213161	11048	Feed Regulating Lever with 213657
200665c	11048	" " " Hinge Screw
213656	14104	" " " Spring .....
213657	14104	" " " " Pin ..
204429	11288	" Wheel .....
223010	14103	" " Driver with two each 201209F and 201515E .....
201209F	14103	Feed Wheel Driver Clutch Stud ...
201515E	14103	" " " " " Nut

No.	Plate	Name
223011	—	Feed Wheel Driver and Clutch complete, Nos. 200263F, 200266D, 201528E, 204308, 204310 and 223010
204308	14104	Feed Wheel Driver Crank with two 200383c .....
200266D	11286	Feed Wheel Driver Crank Hinge Screw .....
200383c	12311	Feed Wheel Driver Crank Set Screw .....
204335	11286	Feed Wheel Driver Guide .....
200162D	11286	" " " " Screw ..
204310	11286	" " " Link .....
200263F	11286	" " " " Hinge Screw
201528E	11285	" " " " " " Nut .....
223043	—	Feed Wheel Driver Spring (spiral)
204190	11292	" " " " Hook (upper) .....
204336	14512	Feed Wheel Frame with 200383c, 204190 and 204321 .....
204424	14101	Feed Wheel Frame Adjusting Eccentric .....
200347c	14103	Feed Wheel Frame Adjusting Eccentric Set Screw .....
200383c	12311	Feed Wheel Frame Set Screw ....
204337	11281	" " " Shaft .....
202305	11285	" " " " Center (2)
200043c	12311	" " " " " Set Screw (2) .....
204317	11286	Feed Wheel Friction Spring .....
200162D	11286	" " " " " Screw
204433	—	Feed Wheel Frame complete, Nos. 204317, 204320, 204335, 204336, 204429, 206047 and four 200162D ..
206047	11286	Feed Wheel Retaining Clutch with 204189 .....
204320	11286	Feed Wheel Retaining Clutch Spring .....
204189	11292	Feed Wheel Retaining Clutch Spring Hook .....
204321	11286	Feed Wheel Retaining Clutch Spring Pin .....
200162D	11286	Feed Wheel Retaining Screw .....
*203482	—	Hook (sewing) .....
203483	11287	" 203482 with 201253E, 201376E and 203251 .....
203671	11287	Hook and Bobbin Case complete, Nos. 203483 and 203669 .....

No.	Plate	Name
213810	11287	Hook Bevel Gear Socket, 24 teeth..
200555H	11007	" " " " Screw ....
203242	11007	" " Pinion, 24 teeth, with two 200383c .....
200383c	12311	Hook Bevel Pinion Set Screw ....
203243	11281	" Counter Shaft .....
203244	11007	" " " Collar with two 200393c .....
200393c	11007	Hook Counter Shaft Collar Set Screw .....
203245	11007	Hook Counter Shaft Driving Gear, 44 teeth, with 200362c and 200439c
200439c	12311	Hook Counter Shaft Driving Gear Position Screw .....
200362c	12311	Hook Counter Shaft Driving Gear Set Screw .....
203246	11007	Hook Counter Shaft Gear, 22 teeth, with two 200383c .....
200383c	12311	Hook Counter Shaft Gear Set Screw
202299	—	" " " Oil Packing (wick) .....
200840E	11007	Hook Counter Shaft Oil Packing (wick) Stop Screw .....
203247	11281	Hook Driving Shaft .....
203248	11288	" " " Bearing with 202299 .....
202299	—	Hook Driving Shaft Bearing Oil Packing (wick) .....
202126	11285	Hook Driving Shaft Bearing Posi- tion Pin .....
200516E	12311	Hook Driving Shaft Bearing Screw
203249	11007	" " " Bushing (eccen- tric) .....
202299	—	Hook Driving Shaft Bushing Oil Packing (wick) .....
200362c	12311	Hook Driving Shaft Bushing Set Screw .....
213141	14107	Hook Driving Shaft Collar with two 200393c .....
200393c	11007	Hook Driving Shaft Collar Set Screw .....
203251	11284	Hook Gib .....
201376F	14104	" " Hinge Screw .....
201253F	14104	" " Screw .....
203504	11288	" Saddle with 200056E .....
200006E	11007	" " Screw (2) .....
225585	11007	" " " Washer (2) .....
213018	14107	" Washer with 203476 and two 204243 .....

No.	Plate	Name
203680	11288	Hook Saddle complete, Nos. 200555H, 203478, 203499, 203504, 203506, 203671, 213018 and 213810
228184	14108	Knee Lifter Connection Lever with 202446 .....
200224H	11285	Knee Lifter Connection Lever Hinge Screw .....
213879	14108	Knee Lifter Connection Lever Lift- ing Rod with 202302 .....
202302	14104	Knee Lifter Connection Lever Lift- ing Rod Cotter Pin .....
202446	14104	Knee Lifter Connection Lever Pin
228181	14102	" " Lifting Lever .....
228183	—	" " " " 228181 with 201178H, 201527H and 228182 ....
228182	14102	Knee Lifter Lifting Lever Bracket
200570E	12311	" " " " " " Screw .....
201178H	14103	Knee Lifter Lifting Lever Hinge Screw .....
201527H	14103	Knee Lifter Lifting Lever Hinge Screw Nut .....
207805	10620	Knife .....
202887	11289	" Bar .....
202888	11289	" " 202887 with 202894, 202895, two each 200585H and 200898D .....
221417	11290	Knife Bar Driving Eccentric with 200382c and 200437c .....
202890	11290	Knife Bar Driving Eccentric Fork with 200382c and 201464c .....
201464c	14103	Knife Bar Driving Eccentric Fork Position Screw .....
200382c	11285	Knife Bar Driving Eccentric Fork Set Screw .....
200437c	12311	Knife Bar Driving Eccentric Posi- tion Screw .....
200382c	11285	Knife Bar Driving Eccentric Set Screw .....
202891	11289	Knife Bar Driving Shaft Crank with 200694E and 201525E .....
200694E	11290	Knife Bar Driving Shaft Crank Screw Stud .....
201525E	11290	Knife Bar Driving Shaft Crank Screw Stud Nut .....
202893	11290	Knife Bar Lifting Spring (spiral)
202894	11290	" " " " Bracket
200585H	11285	" " " " " Screw .....



No.	Plate	Name
200485D	11290	Knife Bar Lifting Spring Thumb Screw .....
202895	14107	Knife Holder .....
200898D	14107	" " Screw .....
202897	14107	" " Switch-in Handle ....
200076D	11290	" Screw (2) .....
202898	11289	" Switch-out Handle with two 200403c .....
200403C	14103	Knife Switch-out Handle Set Screw
202899	11290	" " " Shaft .....
202900	11290	" " " Spring (spiral) .....
213770	11289	Needle Bar (hollow) with 200420F, 200595H and 213771 .....
207072	14104	Needle Bar Bushing (2) .....
200398C	14104	" " " Set Screw (2) ..
204248	11292	" " Connecting Link .....
200658C	11292	" " " " Hinge Screw Stud .....
201519E	11292	Needle Bar Connecting Link Hinge Screw Stud Nut .....
204249	11292	Needle Bar Connecting Stud with 200072c and 202277 .....
202277	---	Needle Bar Connecting Stud Oil Packing (wick) .....
200072C	11292	Needle Bar Connecting Stud Pinch Screw .....
213771	14107	Needle Bar Thread Guide .....
200595H	14103	" " " " Screw ..
200420F	14103	" Set Screw .....
207072	14104	Presser Bar Bushing .....
200398C	14104	" " " Set Screw ....
202339	14104	" " " Lifter .....
200653C	14104	" " " Hinge Screw ...
204455	14104	" " " Lifting Bracket with 200387c .....
213667	14104	Presser Bar Lifting Bracket Position Guide with 200075D and 203551 .....
200075D	11292	Presser Bar Lifting Bracket Position Guide Screw .....
203551	11292	Presser Bar Lifting Bracket Position Guide Screw Bushing .....
200362C	12311	Presser Bar Lifting Bracket Position Guide Set Screw .....
200387C	10473	Presser Bar Lifting Bracket Set Screw .....
204258	11292	Presser Bar Spring (heavy) .....
200494R	14104	" " Thumb Screw (pressure regulating) .....

No.	Plate	Name
201910	11293	Roller Presser, $\frac{1}{2}$ in. diam., $\frac{1}{8}$ in. face (coarse) with 200551c and 201534H .....
208497	----	Roller Presser Arm .....
208498	----	" " " 208497 with 201910 .....
202560	11293	Roller Presser Arm Bracket (swing) .....
208499	----	Roller Presser Arm Bracket 202560 with 200096D and 208498 .....
200675F	11293	Roller Presser Arm Bracket Position Screw Stud .....
202558	11293	Roller Presser Arm Bracket Spring
202559	11293	" " " " " " Stop .....
200141F	11293	Roller Presser Arm Bracket Spring Stop Screw .....
200096D	11293	Roller Presser Arm Screw .....
204495	11289	" " Bar .....
200551C	11293	" " Hinge Screw .....
201534H	11293	" " " " Nut .....
204576	----	Roller Presser and Bar complete, Nos. 200675F, 202558, 202559, 204495, 208499 and two 200141F ..
213006	11288	Take-up Cam with 200335c, 200383c, 200430c, 200658c and 201519E ..
203172	11292	Take-up Cam Friction Washer ...
200430C	12311	" " Position Screw .....
200383C	12311	" " " " Check Screw .....
200335C	12311	Take-up Cam Set Screw .....
203270	11292	" Lever .....
203291	----	" " 203270 with 204263 ..
204263	11292	" " Bearing with 204264 ..
204264	11292	" " " Position Pin ...
200042F	12311	" " " Screw .....
201816	11292	" " Roller .....
203271	11292	Take-up Lever complete, Nos. 200042F, 201816 and 203291 .....
244007	12349	Tension Disc .....
202090	12349	" " Position Pin .....
223423	14107	" Release Lever .....
200309E	12349	" " " Screw .....
202075	12349	" " Plunger .....
223427	14107	" " Slide .....
204457	14104	" " " Spring .....
202737	14101	" " " " Adjusting Collar with 200380c .....
200380C	14107	Tension Release Slide Spring Adjusting Collar Set Screw .....

No.	Plate	Name
202407	10881	Tension Spring .....
200632b	12349	" Stud .....
200397H	12349	" " Set Screw .....
201572b	10881	" Thumb Nut .....
204271	12349	" Washer .....
204272	12349	Tension complete, Nos. 200632b, 201572b, 202075, 202407, 204271 and two 244007 .....
204274	12349	Thread Controller Plate .....
200577H	10473	" " " Screw ....
202098	12349	" " Roller .....
204275	12349	" " Guard .....
202084	12349	" " " Washer .....
200300c	12349	" " " Screw .....
204276	12349	" " Spring .....
204333	12349	" " " Guard .....
200581H	12349	" " " " Screw..
202087	12349	" " " Stop .....
202088	12349	" " " Stud with 204925 .....
200366H	12349	Thread Controller Spring Stud Set Screw .....
204925	11292	Thread Controller Spring Stud Washer .....
205987	12349	Thread Controller complete, Nos. 200300c, 200581H, 202084, 202098, 204274, 204275 and 204333 .....
204280	12349	Thread Controller and Spring com- plete, Nos. 204276 and 205987 ...
202412	11292	Thread Guide .....
202413	11292	" " .....
202091	12349	" Retainer Sleeve .....
202092	12349	" " Spring .....
204058	12349	" " Stud .....
200368H	12349	" " " Set Screw .....
204059	12349	Thread Retainer complete, Nos. 202091, 202092 and 204058 .....
211485	12064	Throat Plate, 60 needle hole, for needle sizes 8 and 9, with 200178b, 200587b, 211416 and 211424, trims opposite the needle and .028, .035, .045, .060 and .085 in. to right of seam .....
213163	14102	Throat Plate Adjusting Lever with 200627E, 201539E, 204387 and two 200479F .....
200264D	11052	Throat Plate Adjusting Lever Hinge Screw .....
200479F	11052	Throat Plate Adjusting Lever Posi- tion Screw .....

No.	Plate	Name
200627E	11052	Throat Plate Adjusting Lever Screw Stud .....
201539E	11052	Throat Plate Adjusting Lever Screw Stud Nut .....
201556D	14103	Throat Plate Adjusting Lever Screw Stud Thumb Nut .....
213112	14101	Throat Plate Adjusting Lever Screw Stud Thumb Nut Washer Plate .....
203152	14103	Throat Plate Adjusting Lever Screw Stud Thumb Nut Washer Plate Pin (2) .....
211424	12024	Throat Plate Knife Follower .....
200587D	14103	" " " " Screw ..
211416	14106	" " " " Spring
200178D	14103	" " " " " Screw .....
200585H	11285	Throat Plate Screw (2) .....
213162	14102	" " Slide Plate (adjust- able) .....
204387	14101	Throat Plate Slide Plate Position Stud .....
200306D	11052	Throat Plate Slide Plate Screw (2)

**LIST OF PARTS COMPLETE**  
**FOR**  
**MACHINE No. 29w15**

**DROP FEED. OBLIQUE UNDEREDGE TRIMMER**

**For Leather**

No.	Plate	Name
*213166	---	Arm .....
213921	11282	" Cap .....
200278H	12311	" " Screw .....
202248	11285	" " " Washer .....
203089	11282	" " Spool Holder Base .....
203090	11282	" " " " " 203089 with 200079H and 204296 .....
200585H	11285	Arm Cap Spool Holder Base Screw
204296	11282	" " " " Wire .....
200079H	12311	" " " " " Hinge Screw .....
213922	---	Arm Cap and Spool Holder complete, Nos. 203090, 213921 and two 200585H .....
200010E	---	Arm Screw (3) .....
202005	11285	" " Washer (3) .....
213158	11281	" Shaft .....
223431	---	" " 213158 with 200244D, 200245D, 213150, 213354, 213654, 213655, 223429, 223430 and two 201528E .....
204801	11282	Arm Shaft Bushing (back) with 202260 .....
202260	---	Arm Shaft Bushing (back) Oil Packing (wick) .....
200338c	11048	Arm Shaft Bushing (back) Set Screw .....
213299	11282	Arm Shaft Bushing (center) with 202260 .....
202260	---	Arm Shaft Bushing (center) Oil Packing (wick) .....
200338c	11048	Arm Shaft Bushing (center) Set Screw .....
204802	11282	Arm Shaft Bushing (front) with 202036 and 202260 .....

No.	Plate	Name
202260	---	Arm Shaft Bushing (front) Oil Packing (wick) .....
200502B	11285	Arm Shaft Bushing (front) Oil Packing Thumb Screw .....
202036	11285	Arm Shaft Bushing (front) Position Pin .....
200341c	11285	Arm Shaft Bushing (front) Set Screw .....
204804	11281	Arm Shaft Connection with four 200054E (2) .....
200054E	11285	Arm Shaft Connection Screw .....
213153	11281	Balance Wheel, 5 1/2 in. diam. (belt groove 2 3/4 in. diam.), with 200328c and 200355c .....
200062H	12311	Balance Wheel Adjusting Screw .....
200328c	12311	" " Position Screw .....
200335c	12311	" " Set Screw .....
*213652	---	Bed with 203248, 203249, two each 200362c, 200516E, 200840E and 202299 .....
202258	12153	Bed Hinge Connection (2) .....
200570E	12311	" " " " Screw (4) .....
203329	11282	" Slide (back) .....
203207	11282	" " (front) .....
203208	11284	Bobbin .....
203210	11284	" Case Base with 202056, 203211 to 203213 and 203216 .....
203211	11284	Bobbin Case Base Latch .....
*202056	---	" " " " Pin .....
203212	11284	" " " " Plunger .....
203213	11284	" " " " Spring .....
203209	11284	" " Cap with 200984c, 203214, 203215 and two 200594c .....
203214	11284	Bobbin Case Tension Spring .....
200984c	11284	" " " " " Regulat- ing Screw .....
200594c	11284	Bobbin Case Tension Spring Screw
203215	11284	" " Thread Guide .....
200594c	11284	" " " " " Screw .....
203216	---	" " " " Washer (cloth) .....
203217	11284	Bobbin Case complete, Nos. 203209 and 203210 .....
201353	11283	Bracket (underedge) with 204411 .....
200517D	11290	" Screw (2) .....
213629	11283	Bracket (underedge) complete, Nos. 200047D, 200118E, 200577H, 200888, 202603, 204233, 204353, 204361, 204363 to 204365, 204368, 204372, 204373, 213772, 213774, 213777, 214053 and two 200028B .....

No.	Plate	Name
223421	14102	Face Plate with 200366u, 200368u, 202087, 202090, 204185 and two 200397u .....
200065c	11285	Face Plate Screw (2) .....
204185	11292	" " Thread Guide .....
200397u	12349	" " " " Set Screw .....
223422	---	Face Plate complete, Nos. 200309f, 200577u, 202088, 204059, 204272, 204280, 223421 and 223423 .....
213146	11282	Feed Bar .....
213229	---	" " 213146 with 200641c, 201522e and 213147 .....
200641c	11048	Feed Bar Hinge Screw .....
201522e	11285	" " " " nut .....
207651	14106	" Dog .....
200106e	12311	" " Screw (2) .....
223429	11298	" Driving Eccentric (adjustable) .....
223430	11298	" " " Adjusting Disc .....
213150	11282	" " " Flange with 200378c and 200437c .....
200437c	12311	Feed Driving Eccentric Flange Position Screw .....
200378c	12311	Feed Driving Eccentric Flange Set Screw .....
213655	11048	Feed Driving Eccentric Friction Spring Washer .....
200245b	11048	Feed Driving Eccentric Friction Spring Washer Screw .....
201528e	11285	Feed Driving Eccentric Friction Spring Washer Screw Nut .....
200244b	11048	Feed Driving Eccentric Fulcrum Screw .....
201528e	11285	Feed Driving Eccentric Fulcrum Screw Nut .....
213147	11281	Feed Driving Rock Shaft .....
202305	11285	" " " " Center (2) .....
200043c	12311	" " " " " Set Screw (2) .....
213354	11281	Feed Driving Rock Shaft Connection with 200054e and 202277 .....
213654	11048	Feed Driving Rock Shaft Connection Collar .....
202298	11048	Feed Driving Rock Shaft Connection Crank with 200038c .....
200038c	11048	Feed Driving Rock Shaft Connection Crank Pinch Screw .....
200545c	11048	Feed Driving Rock Shaft Connection Hinge Screw .....
201518e	11285	Feed Driving Rock Shaft Connection Hinge Screw Nut .....

No.	Plate	Name
202277	----	Feed Driving Rock Shaft Connection Oil Packing (wick) .....
200054e	11285	Feed Driving Rock Shaft Connection Pinch Screw .....
213627	11285	Feed Lifting Cam with 202126 ....
204202	11285	" " " Fork with 200027e .....
200027e	11285	" " " " Pinch Screw .....
202126	11285	" " " " Position Pin ...
200045e	11285	" " " " Screw .....
203236	11281	" " " Rock Shaft .....
203316	11281	" " " " 203236 with 203238 .....
202305	11285	Feed Lifting Rock Shaft Center (2) .....
200043c	12311	" " " " " Set Screw (2) .....
202276	11285	Feed Lifting Rock Shaft Slide Block .....
203238	11285	" " " " " " " " 202276 with 200243e and 201531e .....
200243e	11285	Feed Lifting Rock Shaft Slide Block Hinge Screw .....
201531e	11285	Feed Lifting Rock Shaft Slide Block Hinge Screw Nut .....
213161	11048	Feed Regulating Lever with 213657 .....
200665c	11048	" " " " Hinge Screw .....
213656	14104	" " " " Spring .....
213657	14104	" " " " " Pin ..
204356	11291	Guide Finger .....
204357	10473	" " " " " Clamp with 200103b and 200136e .....
204358	10473	Guide Finger Clamp Bar .....
204359	10473	" " " " " Carrier with 200875 .....
213777	- -	Guide Finger Clamp Bar Carrier 204359 with 204357, 204358, 204366 and 204367 .....
204361	10473	Guide Finger Clamp Bar Carrier Latch .....
200802e	11291	Guide Finger Clamp Bar Carrier Latch Hinge Screw .....
204230	11291	Guide Finger Clamp Bar Carrier Latch Spring .....
204233	10473	Guide Finger Clamp Bar Carrier Latch Spring 204230 with 200802e .....
204364	10473	Guide Finger Clamp Bar Carrier Position Guide with 200078u and 200387c .....
200078u	10473	Guide Finger Clamp Bar Carrier Position Guide Pinch Screw ....
200387c	10473	Guide Finger Clamp Bar Carrier Position Guide Screw .....

No.	Plate	Name
204363	10473	Guide Finger Clamp Bar Carrier Position Guide Slide .....
200577u	10473	Guide Finger Clamp Bar Carrier Position Guide Slide Screw ....
200785d	14104	Guide Finger Clamp Bar Carrier Screw (handle) .....
200875	10473	Guide Finger Clamp Bar Carrier Screw 200785d with 201537u ....
201537u	12319	Guide Finger Clamp Bar Carrier Screw (handle) Nut .....
204365	10473	Guide Finger Clamp Bar Carrier Spring .....
204366	10473	Guide Finger Clamp Bar Position Guide with 200140u .....
200140u	11290	Guide Finger Clamp Bar Position Guide Screw .....
204367	10473	Guide Finger Clamp Bar Spring ...
200103d	10473	" " " " Pinch Screw .....
200136f	14104	Guide Finger Clamp Screw .....
204368	10473	" " Suspending Stop (adjustable) .....
200118f	11290	Guide Finger Suspending Stop Screw .....
202603	11290	Guide Finger Suspending Stop Screw Washer .....
*203463	—	Hook (sewing) .....
203464	11241	" 203463 with 201253f, 201376f and 203251 .....
203465	11241	Hook and Bobbin Case complete, Nos. 203217 and 203464 .....
203241	11007	Hook Bevel Gear Socket, 24 teeth
200555u	11007	" " " " Screw ...
203242	11007	" " Pinion, 24 teeth, with two 200383c .....
200383c	12311	Hook Bevel Pinion Set Screw ....
203243	11281	" Counter Shaft .....
203244	11007	" " " Collar with two 200393c .....
200393c	11007	Hook Counter Shaft Collar Set Screw .....
203245	11007	Hook Counter Shaft Driving Gear, 44 teeth, with 200362c and 200139c
213155	—	Hook Counter Shaft Driving Gear 203245 with 200045e and 213627...
200439c	12311	Hook Counter Shaft Driving Gear Position Screw .....
200362c	12311	Hook Counter Shaft Driving Gear Set Screw .....

No.	Plate	Name
203246	11007	Hook Counter Shaft Gear, 22 teeth, with two 200383c .....
200383c	12311	Hook Counter Shaft Gear Set Screw
202299	—	" " " Oil Packing (wick) .....
200840f	11007	Hook Counter Shaft Oil Packing (wick) Stop Screw .....
203247	11281	Hook Driving Shaft .....
203248	11288	" " " Bearing with 202299 .....
202299	—	Hook Driving Shaft Bearing Oil Packing (wick) .....
202126	11285	Hook Driving Shaft Bearing Position Pin .....
200516f	12311	Hook Driving Shaft Bearing Screw
203249	11007	" " " Bushing (eccentric) .....
202299	—	Hook Driving Shaft Bushing Oil Packing (wick) .....
200362c	12311	Hook Driving Shaft Bushing Set Screw .....
213141	14107	Hook Driving Shaft Collar with two 200393c .....
200393c	11007	Hook Driving Shaft Collar Set Screw .....
203251	11284	Hook Gib .....
201376f	14104	" " Hinge Screw .....
201253f	14104	" " Screw .....
203252	11288	" Saddle with 202299 .....
202299	—	" " Oil Packing (wick) ...
200019f	11285	" " Screw (2) .....
202622	11285	" " " Washer (2) .....
203718	11241	" Washer .....
203466	11288	Hook Saddle complete, Nos. 200555u, 203241, 203252, 203465 and 203718
228184	14108	Knee Lifter Connection Lever with 202446 .....
200224u	11285	Knee Lifter Connection Lever Hinge Screw .....
213879	14108	Knee Lifter Connection Lever Lifting Rod with 202302 .....
202302	14104	Knee Lifter Connection Lever Lifting Rod Cotter Pin .....
202446	14101	Knee Lifter Connection Lever Pin
228181	14102	" " Lifting Lever .....
228183	—	" " " " 228181 with 201178u, 201527u and 228182 ...
228182	14102	Knee Lifter Lifting Lever Bracket
200570f	12311	" " " " " Screw .....

No.	Plate	Name
201178R	14103	Knee Lifter Lifting Lever Hinge Screw .....
201527U	14103	Knee Lifter Lifting Lever Hinge Screw Nut .....
207807	10620	Knife .....
204369	11291	" Bar (hollow) .....
213774	---	" " 204369 with 200094F, 202603 and 204342 .....
204372	11291	Knife Bar Collar with two 200387C
200387C	10473	" " " " Set Screw .....
213780	11289	" " Driving Bar with two 200585U .....
200585U	11285	Knife Bar Driving Bar Screw ....
213178	11291	" " " Collar with 200381C and 200387C .....
213772	---	Knife Bar Driving Collar 213178 with 200097C, 200243E, 200252C, 213179, 213181, 213628 and two 201528E .....
200381C	11291	Knife Bar Driving Collar Screw ..
200387C	10473	" " " " Set Screw
213635	11052	" " " Eccentric with 200382C and 200437C .....
202890	11290	Knife Bar Driving Eccentric Fork with 200382C and 201464C .....
201464C	14103	Knife Bar Driving Eccentric Fork Position Screw .....
200382C	11285	Knife Bar Driving Eccentric Fork Set Screw .....
200437C	12311	Knife Bar Driving Eccentric Position Screw .....
200382C	11285	Knife Bar Driving Eccentric Set Screw .....
213181	11291	Knife Bar Driving Link .....
213179	11291	" " " " Bracket ..
200243E	11285	" " " " Hinge Screw .....
201528E	11285	Knife Bar Driving Link Bracket Hinge Screw Nut .....
200252C	11291	Knife Bar Driving Link Hinge Screw .....
201528E	11285	Knife Bar Driving Link Hinge Screw Nut .....
202891	11289	Knife Bar Driving Shaft Crank with 200694F and 201525E .....
200694F	11290	Knife Bar Driving Shaft Crank Screw Stud .....
201525E	11290	Knife Bar Driving Shaft Crank Screw Stud Nut .....

No.	Plate	Name
213628	11291	Knife Bar Handle .....
200097C	11291	" " " Screw .....
204373	11291	" " Position Guide with 200890 .....
200026D	11291	Knife Bar Position Guide Pinch Screw .....
200890	11291	Knife Bar Position Guide Pinch Screw 200026D with 201534U ....
201534U	11293	Knife Bar Position Guide Pinch Screw Nut .....
200028B	11290	Knife Bar Position Guide Screw ..
204411	11290	" " Sleeve (split) .....
200043C	12311	" " " Set Screw .....
200888	11291	" " " " " 200043C with 201524E .....
201524E	11291	Knife Bar Sleeve Set Screw Nut..
214053	11291	" " Throw-out Spring .....
200047D	14104	" " " " Screw (lower) .....
200301E	11291	Knife Bar Throw-out Spring Screw (upper) .....
204381	---	Knife Holder .....
204342	11291	" " 204381 with two 200126F
200094F	11291	" " Screw .....
202603	11290	" " " Washer .....
200126F	11290	" Screw .....
202898	11289	" Switch-out Handle with two 200103C .....
200403C	14103	Knife Switch-out Handle Set Screw
202899	11290	" " " Shaft ....
202900	11290	" " " Spring (spiral) .....
204383	11289	Needle Bar (hollow) with 200125F, 200175D and 204250 .....
207072	14104	Needle Bar Bushing (2) .....
200398C	14104	" " " Set Screw (2) ..
204248	11292	" " Connecting Link .....
200658C	11292	" " " " Hinge Screw Stud .....
201519E	14107	Needle Bar Connecting Link Hinge Screw Stud Nut .....
204249	11292	Needle Bar Connecting Stud with 200072C and 202277 .....
202277	---	Needle Bar Connecting Stud Oil Packing (wick) .....
200072C	11292	Needle Bar Connecting Stud Pinch Screw .....
204250	11292	Needle Bar Thread Guide .....
200175D	11284	" " " " Screw ..
200125F	11292	" Set Screw .....

No.	Plate	Name
207072	14104	Presser Bar Bushing .....
200398c	14104	" " " Set Screw ....
202339	14104	" " Lifter .....
200653c	14104	" " " Hinge Screw ....
204455	11287	" " Lifting Bracket with 200387c .....
213667	14104	Presser Bar Lifting Bracket Posi- tion Guide with 200075d and 203551 .....
200075d	11292	Presser Bar Lifting Bracket Posi- tion Guide Screw .....
203551	11292	Presser Bar Lifting Bracket Posi- tion Guide Screw Bushing .....
200362c	12311	Presser Bar Lifting Bracket Posi- tion Guide Set Screw .....
200387c	10473	Presser Bar Lifting Bracket Set Screw .....
204258	11292	Presser Bar Spring (heavy) .....
200494b	14104	" " Thumb Screw (pres- sure regulating) .....
201907	11293	Roller Presser, 1½ in. diam., ¾ in. in. face (fine), with 200548c and 201534u .....
202839	11293	Roller Presser Arm .....
204569	11293	" " " 202839 with 201907 .....
202560	11293	Roller Presser Arm Bracket (swing)
204436	—	" " " " 202560 with 200096d and 204569 .....
200675f	11293	Roller Presser Arm Bracket Posi- tion Screw Stud .....
202558	11293	Roller Presser Arm Bracket Spring
202559	11293	" " " " " " Stop .....
200141f	11293	Roller Presser Arm Bracket Spring Stop Screw .....
200096d	11293	Roller Presser Arm Screw .....
204495	11289	" " Bar .....
200548c	11293	" " Hinge Screw .....
201534u	11293	" " " " Nut ....
204437	—	Roller Presser and Bar complete, Nos. 200675f, 202558, 202559, 204436, 204495 and two 200141f ..
213006	11288	Take-up Cam with 200335c, 200383c, 200430c, 200658c and 201519c ..
203172	11292	Take-up Cam Friction Washer ....
200430c	12311	" " Position Screw .....
200383c	12311	" " " " Check Screw .....

No.	Plate	Name
200335c	12311	Take-up Cam Set Screw .....
203270	11292	" Lever .....
203291	—	" " 203270 with 204263 ...
204263	11292	" " Bearing with 204264 ..
204264	11292	" " " Position Pin ...
200042f	12311	" " " Screw .....
201816	11292	" " Roller .....
203271	11292	Take-up Lever complete, Nos. 200042f, 201816 and 203291 .....
244007	12349	Tension Disc .....
202090	12349	" " Position Pin .....
223423	14107	" Release Lever .....
200309i	12349	" " " Screw .....
202075	12349	" " Plunger .....
223427	14107	" " Slide .....
204457	14104	" " " Spring .....
202737	14104	" " " " Adjusting Collar with 200380c .....
200380c	14107	Tension Release Slide Spring Ad- justing Collar Set Screw .....
202407	10881	Tension Spring .....
200632b	12349	" Stud .....
200397h	12349	" " Set Screw .....
201572b	10881	" Thumb Nut .....
204271	12349	" Washer .....
204272	12349	Tension complete, Nos. 200632b, 201572b, 202075, 202407, 204271 and two 244007 .....
204274	12349	Thread Controller Plate .....
200577h	10473	" " " Screw ....
202098	12349	" " Roller .....
204275	12349	" " " Guard .....
202084	12349	" " " " Washer
200300c	12349	" " " Screw .....
204276	12349	" " Spring .....
204333	12349	" " " Guard .....
200581h	12349	" " " " Screw ..
202087	12349	" " " Stop .....
202088	12349	" " " Stud with 204925 .....
200366h	12349	Thread Controller Spring Stud Set Screw .....
204925	11292	Thread Controller Spring Stud Washer .....
205987	12349	Thread Controller complete, Nos. 200300c, 200581h, 202084, 202098, 204274, 204275 and 204333 .....
204280	12349	Thread Controller and Spring com- plete, Nos. 204276 and 205987 ..

No.	Plate	Name
202412	11292	Thread Guide .....
202413	11292	" " .....
202091	12349	" Retainer Sleeve .....
202092	12349	" " Spring .....
204058	12349	" " Stud .....
200368H	12349	" " " Set Screw .....
204059	12349	Thread Retainer complete, Nos. 202091, 202092 and 204058 .....
213163	14102	Throat Plate Adjusting Lever with 200627E, 201539E, 204387 and two 200479F .....
200264D	11052	Throat Plate Adjusting Lever Hinge Screw .....
200479E	11052	Throat Plate Adjusting Lever Position Screw .....
200627E	11052	Throat Plate Adjusting Lever Screw Stud .....
201539E	11052	Throat Plate Adjusting Lever Screw Stud Nut .....
201556D	14103	Throat Plate Adjusting Lever Screw Stud Thumb Nut .....
213112	14101	Throat Plate Adjusting Lever Screw Stud Thumb Nut Washer Plate .....
203152	14103	Throat Plate Adjusting Lever Screw Stud Thumb Nut Washer Plate Pin (2) .....
223444	14106	Throat Plate Body .....
207470	12060	" " Knife Cutting Bar, 53 needle hole, for needle sizes 12 and 13, trims opposite the needle and .040 in. to right of seam .....
200583H	14107	Throat Plate Knife Cutting Bar Screw .....
200585H	11285	Throat Plate Screw (2) .....
213162	14102	" " Slide Plate (adjustable) .....
204387	14101	Throat Plate Slide Plate Position Stud .....
200306D	11052	Throat Plate Slide Plate Screw (2) .....
211499	12061	Throat Plate complete, 53 needle hole, for needle sizes 12 and 13, trims opposite the needle and .040 in. to right of seam, Nos. 207470, 223444 and two 200583H

## LIST OF PARTS COMPLETE

FOR

**MACHINE No. 29w17**

DROP FEED. OBLIQUE UNDEREDGE TRIMMER

For Leather

No.	Plate	Name
*213166	- - -	Arm .....
213921	11282	" Cap .....
200278H	12311	" " Screw .....
202248	11285	" " " Washer .....
203089	11282	" " Spool Holder Base .....
203090	11282	" " " " " " 203089 with 200079H and 204296 .....
200585H	11285	Arm Cap Spool Holder Base Screw
204296	11282	" " " " Wire .....
200079H	12311	" " " " " " Hinge Screw .....
213922	- - -	Arm Cap and Spool Holder complete, Nos. 203090, 213921 and two 200585H .....
200010E	- - -	Arm Screw (3) .....
202005	11285	" " Washer (3) .....
213158	11281	" Shaft .....
223431	- - -	" " 213158 with 200244D, 200245D, 213150, 213354, 213654, 213655, 223429, 223430 and two 201528E .....
204891	11282	Arm Shaft Bushing (back) with 202260 .....
202260	- - -	Arm Shaft Bushing (back) Oil Packing (wick) .....
200338C	11048	Arm Shaft Bushing (back) Set Screw .....
213299	11282	Arm Shaft Bushing (center) with 202260 .....
202260	- - -	Arm Shaft Bushing (center) Oil Packing (wick) .....
200338C	11048	Arm Shaft Bushing (center) Set Screw .....
204802	11282	Arm Shaft Bushing (front) with 202036 and 202260 .....
202260	- - -	Arm Shaft Bushing (front) Oil Packing (wick) .....



No.	Plate	Name
200502b	11285	Arm Shaft Bushing (front) Oil Packing Thumb Screw .....
202036	11285	Arm Shaft Bushing (front) Position Pin .....
200341c	11285	Arm Shaft Bushing (front) Set Screw .....
204804	11281	Arm Shaft Connection with four 200054e (2) .....
200054e	11285	Arm Shaft Connection Screw ....
213153	11281	Balance Wheel, 5½ in. diam. (belt groove 2¾ in. diam.) with 200328c and 200335c .....
200062h	12311	Balance Wheel Adjusting Screw ..
200328c	12311	" " Position Screw ...
200335c	12311	" " Set Screw .....
*213652	----	Bed with 203248, 203249, two each 200362c, 200516e, 200840e and 202299 .....
202258	12153	Bed Hinge Connection (2) .....
200570e	12311	" " " Screw (4) ....
203329	11282	" Slide (back) .....
203207	11282	" " (front) .....
203470	11284	Bobbin .....
*203670	----	" Case .....
203648	11284	" " Latch .....
*202056	----	" " " Pin .....
203473	11284	" " " Plunger .....
203474	11284	" " " Spring .....
203499	11287	" " Lever .....
*203476	----	" " " Eccentric .....
204243	11284	" " " " Position Pin .....
203506	11287	" " " Fulcrum .....
200056E	10882	" " " " Screw ....
203478	11284	" " " Slide Stud .....
203214	11284	" " Tension Spring .....
200984c	11284	" " " " Regulat- ing Screw .....
200594c	11284	Bobbin Case Tension Spring Screw
203216	----	" " Washer (cloth) .....
203669	11284	Bobbin Case complete, Nos. 200594c, 200984c, 202056, 203214, 203216, 203473, 203474, 203648 and 203670
204353	11283	Bracket (underedge) with 204411..
200517D	11290	" Screw (2) .....
213629	11283	Bracket (underedge) complete, Nos. 200047D, 200118E, 200577H, 200888, 202603, 204233, 204353, 204361, 204363 to 204365, 204368, 204372, 204373, 213772, 213774, 213777, 214053 and two 200028B .....

No.	Plate	Name
223421	14102	Face Plate with 200366H, 200368H, 202087, 202090, 204185 and two 200397H .....
200065c	11285	Face Plate Screw (2) .....
204185	11292	" " Thread Guide .....
200397H	12349	" " " " Set Screw
223422	---	Face Plate complete, Nos. 200309E, 200577H, 202088, 204059, 204272, 204280, 223421 and 223423 .....
213146	11282	Feed Bar .....
213229	----	" " 213146 with 200641c, 201522e and 213147 .....
200641c	11048	Feed Bar Hinge Screw .....
201522e	11285	" " " Nut .....
207651	11106	" Dog .....
200106e	12311	" " Screw (2) .....
223429	11298	" Driving Eccentric (adjustable)
223430	11298	" " " Adjusting Disc
213150	11282	" " " Flange with 200378c and 200437c .....
200437c	12311	Feed Driving Eccentric Flange Position Screw .....
200378c	12311	Feed Driving Eccentric Flange Set Screw .....
213655	11048	Feed Driving Eccentric Friction Spring Washer .....
200245D	11048	Feed Driving Eccentric Friction Spring Washer Screw .....
201528e	11285	Feed Driving Eccentric Friction Spring Washer Screw Nut .....
200244D	11048	Feed Driving Eccentric Fulcrum Screw .....
201528e	11285	Feed Driving Eccentric Fulcrum Screw Nut .....
213147	11281	Feed Driving Rock Shaft .....
202305	11285	" " " " Center (2)
200043c	12311	" " " " " Set Screw (2) .....
213354	11281	Feed Driving Rock Shaft Connection with 200054e and 202277 ...
213654	11048	Feed Driving Rock Shaft Connection Collar .....
202298	11048	Feed Driving Rock Shaft Connection Crank with 200038c .....
200038c	11048	Feed Driving Rock Shaft Connection Crank Pinch Screw .....
200545c	11048	Feed Driving Rock Shaft Connection Hinge Screw .....
201518e	11285	Feed Driving Rock Shaft Connection Hinge Screw Nut .....

No.	Plate	Name
202277	---	Feed Driving Rock Shaft Connection Oil Packing (wick) .....
200054E	11285	Feed Driving Rock Shaft Connection Pinch Screw .....
213627	11285	Feed Lifting Cam with 202126 ....
204202	11285	" " " Fork with 200027E
200027E	11285	" " " Pinch Screw
202126	11285	" " " Position Pin ....
200045E	11285	" " " Screw .....
203236	11281	" " Rock Shaft .....
203316	11281	" " " " 203236 with 203238 .....
202305	11285	Feed Lifting Rock Shaft Center (2)
200043C	12311	" " " " " Set Screw (2) .....
202276	11285	Feed Lifting Rock Shaft Slide Block
203238	11285	" " " " " " " " 202276 with 200243E and 201531E
200243E	11285	Feed Lifting Rock Shaft Slide Block Hinge Screw .....
200531E	11285	Feed Lifting Rock Shaft Slide Block Hinge Screw Nut .....
213161	11048	Feed Regulating Lever with 213657
200665C	11048	" " " Hinge Screw
213656	14104	" " " Spring ....
213657	14104	" " " " Pin ..
204356	11291	Guide Finger .....
204357	10473	" " Clamp with 200103D and 200136F .....
204358	10473	Guide Finger Clamp Bar .....
204359	10473	" " " " Carrier with 200875 .....
213777	---	Guide Finger Clamp Bar Carrier 204359 with 204357, 204358, 204366 and 204367 .....
204361	10473	Guide Finger Clamp Bar Carrier Latch .....
200802E	11291	Guide Finger Clamp Bar Carrier Latch Hinge Screw .....
204230	11291	Guide Finger Clamp Bar Carrier Latch Spring .....
204233	10473	Guide Finger Clamp Bar Carrier Latch Spring 204230 with 200802E
204364	10473	Guide Finger Clamp Bar Carrier Position Guide with 200078U and 200387C .....
200078U	10473	Guide Finger Clamp Bar Carrier Position Guide Pinch Screw ....
200387C	10473	Guide Finger Clamp Bar Carrier Position Guide Screw .....

No.	Plate	Name
204363	10473	Guide Finger Clamp Bar Carrier Position Guide Slide .....
200577U	10473	Guide Finger Clamp Bar Carrier Position Guide Slide Screw ....
200785D	14104	Guide Finger Clamp Bar Carrier Screw (handle) .....
200875	10473	Guide Finger Clamp Bar Carrier Screw 200785D with 201537U ....
201537U	10473	Guide Finger Clamp Bar Carrier Screw (handle) Nut .....
204365	10473	Guide Finger Clamp Bar Carrier Spring .....
204366	10473	Guide Finger Clamp Bar Position Guide with 200140U .....
200140U	11290	Guide Finger Clamp Bar Position Guide Screw .....
204367	10473	Guide Finger Clamp Bar Spring ..
200103D	10473	" " " Pinch Screw ..
200136F	14104	" " " Screw .....
204368	10473	" " Suspending Stop (adjustable) .....
200118F	11290	Guide Finger Suspending Stop Screw .....
202603	11290	Guide Finger Suspending Stop Screw Washer .....
*203482	---	Hook (sewing) .....
203483	11287	" 203482 with 201253E, 201376F and 203251 .....
203671	11287	Hook and Bobbin Case complete, Nos. 203483 and 203669 .....
213810	11287	Hook Bevel Gear Socket, 24 teeth
200555U	11007	" " " " Screw ...
203242	11007	" " Pinion, 24 teeth, with two 200383C .....
200383C	12311	Hook Bevel Pinion Set Screw ....
203243	11281	" Counter Shaft .....
203244	11007	" " " Collar with two 200393C .....
200393C	11007	Hook Counter Shaft Collar Set Screw .....
203245	11007	Hook Counter Shaft Driving Gear, 44 teeth, with 200362C and 200439C
213155	---	Hook Counter Shaft Driving Gear 203245 with 200045E and 213627..
200439C	12311	Hook Counter Shaft Driving Gear Position Screw .....
200362C	12311	Hook Counter Shaft Driving Gear Set Screw .....
203246	11007	Hook Counter Shaft Gear, 22 teeth, with two 200383C .....

No.	Plate	Name
200383c	12311	Hook Counter Shaft Gear Set Screw
202299	—	" " " Oil Packing (wick) .....
200840e	11007	Hook Counter Shaft Oil Packing (wick) Stop Screw .....
203247	11281	Hook Driving Shaft .....
203248	11288	" " " Bearing with 202299 .....
202299	—	Hook Driving Shaft Bearing Oil Packing (wick) .....
202126	11285	Hook Driving Shaft Bearing Position Pin .....
200516e	12311	Hook Driving Shaft Bearing Screw
203249	11007	" " " Bushing (eccentric) .....
202299	—	Hook Driving Shaft Bushing Oil Packing (wick) .....
200362c	12311	Hook Driving Shaft Bushing Set Screw .....
213141	14107	Hook Driving Shaft Collar with two 200393e .....
200393c	11007	Hook Driving Shaft Collar Set Screw .....
203251	11284	Hook Gib .....
201376f	14104	" " Hinge Screw .....
201253f	14104	" " Screw .....
203504	11288	" Saddle with 200056e .....
200006e	11007	" " Screw (2) .....
225585	11007	" " Washer (2) .....
213018	—	" Washer with 203476 and two 204243 .....
203680	11288	Hook Saddle complete, Nos. 200555u, 203478, 203499, 203504, 203506, 203671, 213018 and 213810
228184	14108	Knee Lifter Connection Lever with 202246 .....
200224u	11285	Knee Lifter Connection Lever Hinge Screw .....
213879	14108	Knee Lifter Connection Lever Lifting Rod with 202302 .....
202302	14104	Knee Lifter Connection Lever Lifting Rod Cotter Pin .....
202446	14101	Knee Lifter Connection Lever Pin
228181	14102	" " Lifting Lever .....
228183	—	" " " " 228181 with 201178u, 201527u and 228182 ....
228182	14102	Knee Lifter Lifting Lever Bracket
200570e	12311	" " " " " Screw .....

No.	Plate	Name
201178u	14103	Knee Lifter Lifting Lever Hinge Screw .....
201527u	14103	Knee Lifter Lifting Lever Hinge Screw Nut .....
207807	10620	Knife .....
204369	11291	" Bar (hollow) .....
213774	—	" " 204369 with 200094e, 202603 and 204342 .....
204372	11291	Knife Bar Collar with two 200387c
200387c	10473	" " " Set Screw .....
213780	11289	" " Driving Bar with two 200585u .....
200585u	11285	Knife Bar Driving Bar Screw ....
213178	11291	" " " Collar with 200381c and 200387c .....
213772	—	Knife Bar Driving Collar 213178 with 200097c, 200243e, 200252c, 213179, 213181, 213628 and two 201528e .....
200381c	11291	Knife Bar Driving Collar Screw ..
200387c	10473	" " " " Set Screw
213635	11052	" " " Eccentric with 200382c and 200437c .....
202890	11290	Knife Bar Driving Eccentric Fork with 200382c and 201464c .....
201464c	14103	Knife Bar Driving Eccentric Fork Position Screw .....
200382c	11285	Knife Bar Driving Eccentric Fork Set Screw .....
200437c	12311	Knife Bar Driving Eccentric Position Screw .....
200382c	11285	Knife Bar Driving Eccentric Set Screw .....
213181	11291	Knife Bar Driving Link .....
213179	11291	" " " " Bracket
200243e	11285	" " " " " " Hinge Screw .....
201528e	11285	Knife Bar Driving Link Bracket Hinge Screw Nut .....
200252c	11291	Knife Bar Driving Link Hinge Screw .....
201528e	11285	Knife Bar Driving Link Hinge Screw Nut .....
202891	11289	Knife Bar Driving Shaft Crank with 200694e and 201525e .....
200694e	11290	Knife Bar Driving Shaft Crank Screw Stud .....
201525e	11290	Knife Bar Driving Shaft Crank Screw Stud Nut .....

No.	Plate	Name
213628	11291	Knife Bar Handle .....
200097c	11291	" " " Screw .....
204373	11291	" " Position Guide with 200890 .....
200026b	11291	Knife Bar Position Guide Pinch Screw .....
200890	11291	Knife Bar Position Guide Pinch Screw 200026b with 201534u ....
201534u	11293	Knife Bar Position Guide Pinch Screw Nut .....
200028b	11290	Knife Bar Position Guide Screw ..
204411	11290	" " Sleeve (split) .....
200043c	12311	" " " Set Screw .....
200888	11291	" " " " " 200043c with 201524e .....
201524e	11291	Knife Bar Sleeve Set Screw Nut..
214053	11291	" " Throw-out Spring .....
200047b	14104	" " " Screw (lower) .....
200301e	11291	Knife Bar Throw-out Spring Screw (upper) .....
204381	---	Knife Holder .....
204342	11291	" " 204381 with two 200126f
200094f	11291	" " Screw .....
202603	11290	" " Washer .....
200126f	11290	" Screw .....
202898	11289	" Switch-out Handle with two 200403c .....
200403c	14103	Knife Switch-out Handle Set Screw
202899	11290	" " " Shaft .....
202900	11290	" " " Spring (spiral) .....
204383	11289	Needle Bar (hollow) with 200125f, 200175b and 204250 .....
207072	14104	Needle Bar Bushing (2) .....
200398c	14104	" " " Set Screw (2) ..
204248	11292	" " Connecting Link .....
200658c	11292	" " " " Hinge Screw Stud .....
201519e	11292	Needle Bar Connecting Link Hinge Screw Stud Nut .....
204249	11292	Needle Bar Connecting Stud with 200072c and 202277 .....
202277	---	Needle Bar Connecting Stud Oil Packing (wick) .....
200072c	11292	Needle Bar Connecting Stud Pinch Screw .....
204250	11292	Needle Bar Thread Guide .....
200175b	11284	" " " " Screw ..
200125f	11292	" Set Screw .....

No.	Plate	Name
207072	14104	Presser Bar Bushing .....
200398c	14104	" " " Set Screw ...
202339	14104	" " Lifter .....
200653c	14104	" " " Hinge Screw ...
204455	11287	" " Lifting Bracket with 200387c .....
213667	14104	Presser Bar Lifting Bracket Posi- tion Guide with 200075b and 203551 .....
200075b	11292	Presser Bar Lifting Bracket Posi- tion Guide Screw .....
203551	11292	Presser Bar Lifting Bracket Posi- tion Guide Screw Bushing .....
200362c	12311	Presser Bar Lifting Bracket Posi- tion Guide Set Screw .....
200387c	10473	Presser Bar Lifting Bracket Set Screw .....
204258	11292	Presser Bar Spring (heavy) .....
200494b	14104	" " Thumb Screw (pres- sure regulating) .....
201907	11293	Roller Presser, 1 1/2 in. diam., 3/8 in. face (fine), with 200548c and 201534u .....
202839	11293	Roller Presser Arm .....
204569	11293	" " " 202839 with 201907 .....
202560	11293	Roller Presser Arm Bracket (swing)
204436	---	" " " " 202560 with 200096b and 204569 .....
200675f	11293	Roller Presser Arm Bracket Posi- tion Screw Stud .....
202558	11293	Roller Presser Arm Bracket Spring
202559	11293	" " " " " " Stop .....
200141f	11293	Roller Presser Arm Bracket Spring Stop Screw .....
200096b	11293	Roller Presser Arm Screw .....
204495	11289	" " Bar .....
200548c	11293	" " Hinge Screw .....
201534u	11293	" " " " Nut .....
204437	---	Roller Presser and Bar complete, Nos. 200675f, 202558, 202559, 204436, 204495 and two 200141f ..
213006	11288	Take-up Cam with 200335c, 200383c, 200430c, 200658c and 201519e ...
203172	11292	Take-up Cam Friction Washer ...
200430c	12311	" " Position Screw .....
200383c	12311	" " " " Check Screw .....

No.	Plate	Name
200335c	12311	Take-up Cam Set Screw .....
203270	11292	" Lever .....
203291	—	" " 203270 with 204263 ..
204263	11292	" " Bearing with 204264 ..
204264	11292	" " Position Pin ...
200042F	12311	" " " Screw .....
201816	11292	" " Roller .....
203271	11292	Take-up Lever complete, Nos 200042F, 201816 and 203291 ....
244007	12349	Tension Disc .....
202090	12349	" " Position Pin .....
223423	14107	" Release Lever .....
200309E	12349	" " " Screw .....
202075	12349	" " Plunger .....
223427	14107	" " Slide .....
204457	14104	" " " Spring .....
202737	14104	" " " " Adjusting Collar with 200380c .....
200380c	14107	Tension Release Slide Spring Ad- justing Collar Set Screw .....
202407	10881	Tension Spring .....
200632B	12349	" Stud .....
200397H	12349	" " Set Screw .....
201572B	10881	" Thumb Nut .....
204271	12349	" Washer .....
204272	12349	Tension complete, Nos. 200632B, 201572B, 202075, 202407, 204271 and two 244007 .....
204274	12349	Thread Controller Plate .....
200577H	10473	" " " Screw ....
202098	12349	" " Roller .....
204275	12349	" " " Guard .....
202084	12349	" " " " Washer .....
200300H	12349	" " " Screw .....
204276	12349	" " Spring .....
204333	12349	" " " Guard .....
200581H	12349	" " " " Screw..
202087	12349	" " " Stop .....
202088	12349	" " " Stud with 204925 .....
200366H	12349	Thread Controller Spring Stud Set Screw .....
204925	11292	Thread Controller Spring Stud Washer .....
205987	12349	Thread Controller complete, Nos. 200300c, 200581H, 202084, 202098, 204274, 204275 and 204333 .....
204280	12349	Thread Controller and Spring com- plete, Nos. 204276 and 205987 ...

No.	Plate	Name
202412	11292	Thread Guide .....
202413	11292	" " .....
202091	12349	" Retainer Sleeve .....
202092	12349	" " Spring .....
204058	12349	" " Stud .....
200368H	12349	" " " Set Screw ....
204059	12349	Thread Retainer complete, Nos. 202091, 202092 and 204058 .....
213163	14102	Throat Plate Adjusting Lever with 200627E, 201539E, 204387 and two 200479F .....
200264D	11052	Throat Plate Adjusting Lever Hinge Screw .....
200479F	11052	Throat Plate Adjusting Lever Posi- tion Screw .....
200627E	11052	Throat Plate Adjusting Lever Screw Stud .....
201539E	11052	Throat Plate Adjusting Lever Screw Stud Nut .....
201556D	14103	Throat Plate Adjusting Lever Screw Stud Thumb Nut .....
213112	14101	Throat Plate Adjusting Lever Screw Stud Thumb Nut Washer Plate .....
203152	14103	Throat Plate Adjusting Lever Screw Stud Thumb Nut Washer Plate Pin (2) .....
223446	14106	Throat Plate Body .....
207470	12060	" " Knife Cutting Bar, 53 needle hole, for needle sizes 12 and 13, trims opposite the needle and .040 in. to right of seam ..
200583H	14107	Throat Plate Knife Cutting Bar Screw .....
200585H	11285	Throat Plate Screw (2) .....
213162	14102	" " Slide Plate (adjustable)
204387	14101	" " " " Position Stud
200306D	11052	" " " " Screw (2) ..
211521	12065	Throat Plate complete, 53 needle hole, for needle sizes 12 and 13, trims opposite the needle and .040 in. to right of seam, Nos. 207470, 223446 and two 200583H .....

## LIST OF PARTS COMPLETE

FOR

## MACHINE No. 29w21

WHEEL FEED. OBLIQUE UNDEREDGE TRIMMER

For Leather and Gloves

No.	Plate	Name
*213166	—	Arm .....
213921	11282	" Cap .....
200278H	12311	" " Screw .....
202248	11285	" " " Washer .....
203089	11282	" " Spool Holder Base .....
203090	11282	" " " " " 203089 with 200079H and 204296 .....
200585H	11285	Arm Cap Spool Holder Base Screw
204296	11282	" " " " Wire .....
200079H	12311	" " " " " Hinge Screw .....
213922	—	Arm Cap and Spool Holder complete, Nos. 203090, 213921 and two 200585H .....
200010E	—	Arm Screw (3) .....
202005	11285	" " Washer (3) .....
213158	11281	" Shaft .....
223431	—	" " 213158 with 200244D, 200245D, 213150, 213354, 213654, 213655, 223429, 223430 and two 201528E .....
204801	11282	Arm Shaft Bushing (back) with 202260 .....
202260	—	Arm Shaft Bushing (back) Oil Packing (wick) .....
200338c	11048	Arm Shaft Bushing (back) Set Screw .....
213299	11282	Arm Shaft Bushing (center) with 202260 .....
202260	—	Arm Shaft Bushing (center) Oil Packing (wick) .....
200338c	11048	Arm Shaft Bushing (center) Set Screw .....
204802	11282	Arm Shaft Bushing (front) with 202036 and 202260 .....

No.	Plate	Name
202260	—	Arm Shaft Bushing (front) Oil Packing (wick) .....
200502B	11285	Arm Shaft Bushing (front) Oil Packing Thumb Screw .....
202036	11285	Arm Shaft Bushing (front) Position Pin .....
200341c	11285	Arm Shaft Bushing (front) Set Screw .....
204804	11281	Arm Shaft Connection with four 200054E (2) .....
200054E	11285	Arm Shaft Connection Screw .....
213153	11281	Balance Wheel, 5½ in. diam. (belt groove 2¾ in. diam.), with 200328c and 200335c .....
200062H	12311	Balance Wheel Adjusting Screw ..
200328c	12311	" " Position Screw .....
200335c	12311	" " Set Screw .....
*213868	—	Bed with 203248, 203249, two each 200362c, 200516E, 200840E and 202299 .....
202258	12153	Bed Hinge Connection (2) .....
200570E	12311	" " " Screw (4) .....
203329	11282	" Slide (back) .....
203207	11282	" " (front) .....
203208	11284	Bobbin .....
203210	11284	" Case Base with 202056, 203211 to 203213 and 203216 .....
203211	11284	Bobbin Case Base Latch .....
*202056	—	" " " " Pin .....
203212	11284	" " " " Plunger ..
203213	11284	" " " " Spring ..
203209	11284	" " Cap with 200984c, 203214, 203215 and two 200594c..
203214	11284	Bobbin Case Tension Spring .....
200984c	11284	" " " " Regulat- ing Screw .....
200594c	11284	Bobbin Case Tension Spring Screw
203216	—	" " Washer (cloth) .....
203217	11284	Bobbin Case complete, Nos. 203209 and 203210 .....
204353	11283	Bracket (underedge) with 204411 ..
200517D	11290	" Screw (2) .....
213629	11283	Bracket (underedge) complete, Nos. 200047D, 200118E, 200577H, 200888, 202603, 204233, 204353, 204361, 204363 to 204365, 204368, 204372, 204373, 213772, 213774, 213777, 214073 and two 200028H .....

No.	Plate	Name
223421	14102	Face Plate with 200366n, 200368n, 202087, 202090, 204185 and two 200397n .....
200065c	11285	Face Plate Screw (2) .....
204185	11292	" " Thread Guide .....
200397n	12349	" " " " Set Screw
223422	—	Face Plate complete, Nos. 200309n, 200577n, 202088, 204059, 204272, 204280, 223421 and 223423 .....
223429	11298	Feed Driving Eccentric (adjustable)
223430	11298	" " " Adjusting Disc
213150	11282	" " " Flange with 200378c and 200437c .....
200437c	12311	Feed Driving Eccentric Flange Posi- tion Screw .....
200378c	12311	Feed Driving Eccentric Flange Set Screw .....
213655	11048	Feed Driving Eccentric Friction Spring Washer .....
200245d	11048	Feed Driving Eccentric Friction Spring Washer Screw .....
201528e	11285	Feed Driving Eccentric Friction Spring Washer Screw Nut .....
200244d	11048	Feed Driving Eccentric Fulerum Screw .....
201528e	11285	Feed Driving Eccentric Fulerum Screw Nut .....
213863	11281	Feed Driving Rock Shaft .....
202305	11285	" " " " Center (2)
200043c	12311	" " " " " Set Screw (2) .....
213354	11281	Feed Driving Rock Shaft Connec- tion with 200054e and 202277 ..
213654	11048	Feed Driving Rock Shaft Connec- tion Collar .....
202298	11048	Feed Driving Rock Shaft Connec- tion Crank with 200038c .....
200038c	11048	Feed Driving Rock Shaft Connec- tion Crank Pinch Screw .....
200545c	11048	Feed Driving Rock Shaft Connec- tion Hinge Screw .....
201518e	11285	Feed Driving Rock Shaft Connec- tion Hinge Screw Nut .....
202277	—	Feed Driving Rock Shaft Connec- tion Oil Packing (wick) .....
200054e	11285	Feed Driving Rock Shaft Connec- tion Pinch Screw .....

No.	Plate	Name
213161	11048	Feed Regulating Lever with 213657
200665c	11048	" " " Hinge Screw
213656	14104	" " " Spring .....
213657	14104	" " " " Pin ..
204303	11288	" Wheel .....
223010	14103	" " Driver with two each each 201209e and 201515e .....
201209e	14103	Feed Wheel Driver Clutch Stud ..
201515e	14103	" " " " " Nut
223011	—	Feed Wheel Driver and Clutch com- plete, Nos. 200263e, 200266d, 201528e, 204308, 204310 and 223010
204308	14104	Feed Wheel Driver Crank with two 200383c .....
200266d	11286	Feed Wheel Driver Crank Hinge Screw .....
200383c	12311	Feed Wheel Driver Crank Set Screw .....
204335	11286	Feed Wheel Driver Guide .....
200162d	11286	" " " " Screw ..
204310	11286	" " " Link .....
200263e	11286	" " " " Hinge Screw
201528e	11285	" " " " " " "
		Nut .....
223043	—	Feed Wheel Driver Spring (spiral)
204190	11292	" " " " Hook (upper) .....
204336	14512	Feed Wheel Frame with 200383c, 204190 and 204321 .....
204315	11286	Feed Wheel Frame Adjusting Eccentric .....
200347c	14103	Feed Wheel Frame Adjusting Eccentric Set Screw .....
200383c	12311	Feed Wheel Frame Set Screw .....
204337	11281	" " " Shaft .....
202305	11285	" " " " Center (2)
200043c	12311	" " " " " Set Screw (2) .....
204317	11286	Feed Wheel Friction Spring .....
200162d	11286	" " " " Screw
204425	—	Feed Wheel Frame complete, Nos. 204303, 204317, 204320, 204335, 204336, 206047 and four 200162d
206047	11286	Feed Wheel Retaining Clutch with 204189 .....
204320	11286	Feed Wheel Retaining Clutch Spring .....
204189	11292	Feed Wheel Retaining Clutch Spring Hook .....

No.	Plate	Name
204321	11286	Feed Wheel Retaining Clutch Spring Pin .....
200162D	11286	Feed Wheel Retaining Screw ....
204355	11291	Guide Finger, for trimming back of needle .....
204356	11291	Guide Finger, for trimming abreast of needle .....
204357	10473	Guide Finger Clamp with 200103D and 200136F .....
204358	10473	Guide Finger Clamp Bar .....
204359	10473	" " " " Carrier with 200875 .....
213777	—	Guide Finger Clamp Bar Carrier 204359 with 204357, 201358, 204266 and 204367 .....
204361	10473	Guide Finger Clamp Bar Carrier Latch .....
200802E	11291	Guide Finger Clamp Bar Carrier Latch Hinge Screw .....
204230	11291	Guide Finger Clamp Bar Carrier Latch Spring .....
204233	10473	Guide Finger Clamp Bar Carrier Latch Spring 204230 with 200802E .....
204364	10473	Guide Finger Clamp Bar Carrier Position Guide with 200078H and 200387C .....
200078H	10473	Guide Finger Clamp Bar Carrier Position Guide Pinch Screw ....
200387C	10473	Guide Finger Clamp Bar Carrier Position Guide Screw .....
204363	10473	Guide Finger Clamp Bar Carrier Position Guide Slide .....
200577H	10473	Guide Finger Clamp Bar Carrier Position Guide Slide Screw ....
200785D	14104	Guide Finger Clamp Bar Carrier Screw (handle) .....
200875	10473	Guide Finger Clamp Bar Carrier Screw 200785D with 201537H ....
201537H	10473	Guide Finger Clamp Bar Carrier Screw (handle) Nut .....
204365	10473	Guide Finger Clamp Bar Carrier Spring .....
204366	10473	Guide Finger Clamp Bar Position Guide with 200149H .....
200149H	11290	Guide Finger Clamp Bar Position Guide Screw .....
204367	10473	Guide Finger Clamp Bar Spring ..
200103D	10473	" " " Pinch Screw ..
200136F	14104	" " " Screw .....

No.	Plate	Name
204368	10473	Guide Finger Suspending Stop (adjustable) .....
200118F	11290	Guide Finger Suspending Stop Screw .....
202603	11290	Guide Finger Suspending Stop Screw Washer .....
*203463	—	Hook (sewing) .....
203464	11241	" 203463 with 201253F, 201376F and 203251 .....
203465	11241	Hook and Bobbin Case complete, Nos. 203217 and 203464 .....
203241	11007	Hook Bevel Gear Socket, 24 teeth
200555H	11007	" " " " Screw ...
203242	11007	" " Pinion, 24 teeth, with two 200383C .....
200383C	12311	Hook Bevel Pinion Set Screw ....
203243	11281	" Counter Shaft .....
203244	11007	" " " Collar with two 200393C .....
200393C	11007	Hook Counter Shaft Collar Set Screw .....
203245	11007	Hook Counter Shaft Driving Gear, 44 teeth, with 200362C and 200439C .....
200439C	12311	Hook Counter Shaft Driving Gear Position Screw .....
200362C	12311	Hook Counter Shaft Driving Gear Set Screw .....
203246	11007	Hook Counter Shaft Gear, 22 teeth, with two 200383C .....
200383C	12311	Hook Counter Shaft Gear Set Screw
202299	—	" " " Oil Packing (wick) .....
200840E	11007	Hook Counter Shaft Oil Packing (wick) Stop Screw .....
203247	11281	Hook Driving Shaft .....
203248	11288	" " " Bearing with 202299 .....
202299	—	Hook Driving Shaft Bearing Oil Packing (wick) .....
202126	11285	Hook Driving Shaft Bearing Position Pin .....
200516E	12311	Hook Driving Shaft Bearing Screw
203249	11007	" " " Bushing (eccentric) .....
202299	—	Hook Driving Shaft Bushing Oil Packing (wick) .....
200362C	12311	Hook Driving Shaft Bushing Set Screw .....
213141	11282	Hook Driving Shaft Collar with two 200393C .....



No.	Plate	Name
200393C	11007	Hook Driving Shaft Collar Set Screw .....
203251	11284	Hook Gib .....
201376F	14104	" " Hinge Screw .....
201253F	14104	" " Screw .....
203252	11288	" Saddle with 202299 .....
202299	—	" " Oil Packing (wick) ....
200019E	11285	" " Screw (2) .....
202622	11285	" " Washer (2) .....
203718	11241	" Washer .....
203466	11288	Hook Saddle complete, Nos. 200555H, 203241, 203252, 203465 and 203718
228184	14108	Knee Lifter Connection Lever with 202446 .....
200224H	11285	Knee Lifter Connection Lever Hinge Screw .....
213879	14108	Knee Lifter Connection Lever Lifting Rod with 202302 .....
202302	14104	Knee Lifter Connection Lever Lifting Rod Cotter Pin .....
202446	14101	Knee Lifter Connection Lever Pin
228181	14102	" " Lifting Lever .....
228183	—	" " " " 228181 with 201178H, 201527H and 228182 ...
228182	14102	Knee Lifter Lifting Lever Bracket
200570E	12311	" " " " " " Screw .....
201178H	14103	Knee Lifter Lifting Lever Hinge Screw .....
201527H	14103	Knee Lifter Lifting Lever Hinge Screw Nut .....
207807	10620	Knife .....
204369	11291	" Bar (hollow) .....
213774	—	" " 204369 with 200094E, 202603 and 204342 .....
204372	11291	Knife Bar Collar with two 200387C
200387C	10473	" " " Set Screw .....
213780	11289	" " Driving Bar with two 200585H .....
200585H	11285	Knife Bar Driving Bar Screw ....
213178	11291	" " " Collar with 200381C and 200387C .....
213772	—	Knife Bar Driving Collar 213178 with 200097C, 200243E, 200252C, 213179, 213181, 213628 and two 201528E .....
200381C	11291	Knife Bar Driving Collar Screw ..
200387C	10473	" " " " Set Screw
213635	11052	" " " Eccentric with 200382C and 200437C .....

No.	Plate	Name
202890	11290	Knife Bar Driving Eccentric Fork with 200382C and 201464C .....
201464C	14103	Knife Bar Driving Eccentric Fork Position Screw .....
200382C	11285	Knife Bar Driving Eccentric Fork Set Screw .....
200437C	12311	Knife Bar Driving Eccentric Position Screw .....
200382C	11285	Knife Bar Driving Eccentric Set Screw .....
213181	11291	Knife Bar Driving Link .....
213179	11291	" " " " Bracket ...
200243E	11285	" " " " " Hinge Screw .....
201528E	11285	Knife Bar Driving Link Bracket Hinge Screw Nut .....
200252C	11291	Knife Bar Driving Link Hinge Screw .....
201528E	11285	Knife Bar Driving Link Hinge Screw Nut .....
202891	11289	Knife Bar Driving Shaft Crank with 200694C and 201525E .....
200694E	11290	Knife Bar Driving Shaft Crank Screw Stud .....
201525E	11290	Knife Bar Driving Shaft Crank Screw Stud Nut .....
213628	11291	Knife Bar Handle .....
200097C	11291	" " " Screw .....
204373	11291	" " Position Guide with 200890 .....
200026D	11291	Knife Bar Position Guide Pinch Screw .....
200890	11291	Knife Bar Position Guide Pinch Screw 200026D with 201534H ....
201534H	11293	Knife Bar Position Guide Pinch Screw Nut .....
200028B	11290	Knife Bar Position Guide Screw ..
204411	11290	" " Sleeve (split) .....
200043C	12311	" " " Set Screw .....
200888	11291	" " " " " 200043C with 201524E .....
201524E	11291	Knife Bar Sleeve Set Screw Nut ..
214053	11291	" " Throw-out Spring .....
200047D	14104	" " " " Screw (lower) .....
200301E	11291	Knife Bar Throw-out Spring Screw (upper) .....

No.	Plate	Name
204381	---	Knife Holder .....
204342	11291	" " 204381 with two 200126F
200094F	11291	" " " Screw .....
202603	11290	" " " Washer .....
200126F	11290	" Screw .....
202898	11289	" Switch-out Handle with two 200403c .....
200403c	14103	Knife Switch-out Handle Set Screw
202899	11290	" " " Shaft ....
202900	11290	" " " Spring (spiral) .....
204383	11289	Needle Bar (hollow) with 200125c, 200175b and 204250 .....
207072	14104	Needle Bar Bushing (2) .....
200398c	14104	" " " Set Screw (2) ..
204248	11292	" " " Connecting Link .....
200658c	11292	" " " " Hinge Screw Stud .....
201519E	11292	Needle Bar Connecting Link Hinge Screw Stud Nut .....
204249	11292	Needle Bar Connecting Stud with 200072c and 202277 .....
202277	---	Needle Bar Connecting Stud Oil Packing (wick) .....
200072c	11292	Needle Bar Connecting Stud Pinch Screw .....
204250	11292	Needle Bar Thread Guide .....
200175b	11284	" " " " Screw ..
200125F	11292	" Set Screw .....
207072	14104	Presser Bar Bushing .....
200398c	14104	" " " Set Screw ....
202339	14104	" " " Lifter .....
200653c	14104	" " " Hinge Screw ...
204455	11287	" " " Lifting Bracket with 200387c .....
213667	14104	Presser Bar Lifting Bracket Posi- tion Guide with 200075b and 203551 .....
200075b	11292	Presser Bar Lifting Bracket Posi- tion Guide Screw .....
203551	11292	Presser Bar Lifting Bracket Posi- tion Guide Screw Bushing .....
200362c	12311	Presser Bar Lifting Bracket Posi- tion Guide Set Screw .....
200387c	10473	Presser Bar Lifting Bracket Set Screw .....
204258	11292	Presser Bar Spring (heavy) .....
200494B	14104	" " Thumb Screw (pres- sure regulating) .....

No.	Plate	Name
201907	11293	Roller Presser, 1 $\frac{1}{2}$ in. diam., $\frac{5}{8}$ in. face (fine), with 200548c and 201534u .....
202839	11293	Roller Presser Arm .....
204569	11293	" " " 202839 with 201907 .....
202560	11293	Roller Presser Arm Bracket (swing)
204436	-----	" " " " 250560 with 200096b and 204569 .....
200675F	11293	Roller Presser Arm Bracket Posi- tion Screw Stud .....
202558	11293	Roller Presser Arm Bracket Spring
202559	11293	" " " " " " Stop .....
200141F	11293	Roller Presser Arm Bracket Spring Stop Screw .....
200096b	11293	Roller Presser Arm Screw .....
204495	11289	" " Bar .....
200548c	11293	" " Hinge Screw .....
201534u	11293	" " " " Nut .....
204437	---	Roller Presser and Bar complete, Nos. 200675F, 202558, 202559, 204436, 204495 and two 200141F ..
213006	11288	Take-up Cam with 200335c, 200383c, 200430c, 200658c and 201519E ...
203172	11292	Take-up Cam Friction Washer ....
200430c	12311	" " Position Screw .....
200383c	12311	" " " " Check Screw .....
200335c	12311	Take-up Cam Set Screw .....
203270	11292	" Lever .....
203291	-----	" " 203270 with 204263 ...
204263	11292	" " Bearing with 204264 ..
204264	11292	" " " Position Pin ...
200042F	12311	" " " Screw .....
201816	11292	" " Roller .....
203271	11292	Take-up Lever complete, Nos. 200042F, 201816 and 203291 ....
244007	12349	Tension Disc .....
202090	12349	" " Position Pin .....
223423	14107	" Release Lever .....
200309E	12349	" " " Screw .....
202075	12349	" " Plunger .....
223427	14107	" " Slide .....
204457	14104	" " " Spring .....
202737	14104	" " " " Adjusting Collar with 200380c .....
200380c	14107	Tension Release Slide Spring Ad- justing Collar Set Screw .....

No.	Plate	Name
202407	10881	Tension Spring .....
200632B	12349	" Stud .....
200397H	12349	" " Set Screw .....
201572B	10881	" Thumb Nut .....
204271	12349	" Washer .....
204272	12249	Tension complete, Nos. 200632B, 201572B, 202075, 202407, 204271 and two 244007 .....
204274	12349	Thread Controller Plate .....
200577H	10473	" " " Screw .....
202098	12349	" " Roller .....
204275	12249	" " " Guard .....
202084	12249	" " " " Washer .....
200300C	12349	" " " Screw .....
204276	12349	" " Spring .....
204333	12349	" " " Guard .....
200581H	12349	" " " " Screw .....
202087	12349	" " " Stop .....
202088	12349	" " " Stud with 204925 .....
200366H	12349	Thread Controller Spring Stud Set Screw .....
204925	11292	Thread Controller Spring Stud Washer .....
205987	12349	Thread Controller complete, Nos. 200300C, 200581H, 202084, 202098, 204274, 204275 and 204333 .....
204280	12349	Thread Controller and Spring com- plete, Nos. 204276 and 205987 .....
202412	11292	Thread Guide .....
202413	11292	" " .....
202091	12349	" Retainer Sleeve .....
202092	12349	" " Spring .....
204058	12349	" " Stud .....
200368H	12349	" " " Set Screw .....
204059	12349	Thread Retainer complete, Nos. 202091, 202092 and 204058 .....
213163	14102	Throat Plate Adjusting Lever with 200627E, 201539E, 204387 and two 200479F .....
200264D	11052	Throat Plate Adjusting Lever Hinge Screw .....
200479F	11052	Throat Plate Adjusting Lever Posi- tion Screw .....
200627E	11052	Throat Plate Adjusting Lever Screw Stud .....
201539E	11052	Throat Plate Adjusting Lever Screw Stud Nut .....
201556D	14103	Throat Plate Adjusting Lever Screw Stud Thumb Nut .....

No.	Plate	Name
213112	14101	Throat Plate Adjusting Lever Screw Stud Thumb Nut Washer Plate .....
203152	14103	Throat Plate Adjusting Lever Screw Stud Thumb Nut Washer Plate Pin (2) .....
223443	14106	Throat Plate Body .....
207464	12059	" " Knife Cutting Bar, 53 needle hole, for needle sizes 12 and 13, trims back of needle and .015 in. to right of seam .....
200583H	14107	Throat Plate Knife Cutting Bar Screw .....
200585H	11285	Throat Plate Screw (2) .....
213162	14102	" " Slide Plate (adjustable)
204387	14101	" " " Position Stud
200306D	11052	" " " " Screw (2) ..
211493	12061	Throat Plate complete, 53 needle hole, for needle sizes 12 and 13, trims back of needle and .015 in. to right of seam, Nos. 207464, 223443 and two 200583H .....

**MACHINE No. 29w23**

DROP FEED. OBLIQUE UNDEREDGE TRIMMER

For Leather

The same as Machine No. 29w15 with the following exceptions:

No.	Plate	Name
204355	11291	Guide Finger, in place of 204356 ..
223443	14106	Throat Plate Body, in place of 223444 .....
207464	12059	Throat Plate Knife Cutting Bar, 53 needle hole, for needle sizes 12 and 13, trims back of needle and .015 in. to right of seam, in place of 207470 .....
211493	12061	Throat Plate complete, 53 needle hole, for needle sizes 12 and 13, trims back of needle and .015 in. to right of seam, Nos. 207464, 223443 and two 200583u, in place of 211499 .....

**MACHINE No. 29w27**

DROP FEED. OBLIQUE UNDEREDGE TRIMMER

For Leather

Same as Machine No. 29w17 with the following exceptions:

No.	Plate	Name
204355	11291	Guide Finger, in place of 204356 ..
223445	14106	Throat Plate Body, in place of 223446 .....
207464	12059	Throat Plate Knife Cutting Bar, 53 needle hole, for needle sizes 12 and 13, trims back of needle and .015 in. to right of seam, in place of 207470 .....
211515	12065	Throat Plate complete, 53 needle hole, for needle sizes 12 and 13, trims back of needle and .015 in. to right of seam, Nos. 207464, 223445 and two 200583u, in place of 211521 .....

## ACCESSORIES

FOR MACHINE No. 29w2

No.	Plate	Name
203208	11284	Bobbin (5) .....
*225482	---	" Case Screw Driver Blade ..
*225483	---	" " " " Handle ..
225497	12153	Bobbin Case Screw Driver complete, Nos. 225482 and 225483 ..
225487	14104	Roller Presser Hinge Screw Nut Wrench .....
207805	10620	Trimmer Knife (3) .....
128 x 4	---	Needles, two each, sizes 11, 12 and 13 .....
228212	---	Drip Pan with four 1 in. wire nails
41400	12153	Machine Rest Pin (wood) .....
120342	12153	Oiler (copper plated) with 120343..
120343	12153	" Spout, 3½ in. long .....
*225484	---	Screw Driver Blade .....
*225485	---	" " Handle .....
225498	12153	Screw Driver complete (7¼ in. long), Nos. 225484 and 225485 ..
225554	12153	Wrench (steel) .....

### BOBBIN WINDER

Swing Automatic, Right Hand

225453	10884	Frame with 202277 and 225438 ...
225454	10884	" Hinge Pin .....
202277	---	" Oil Packing (wick) .....
225438	10884	" " Well Cap .....
225455	10884	" Spring .....
225456	10884	" " Plunger .....
202473	10885	Pulley with 200380c .....
200380c	14107	" Set Screw .....
225381	10884	Spindle .....
225444	10884	Stop Latch .....
200056E	10884	" " Screw .....
225458	10884	" " Thumb Lever .....
225459	10884	" " " " Hinge Stud
225459	10884	" " " " Joint Stud
202478	10884	" " Trip Lever .....
200299H	10884	" " " " Hinge Screw

No.	Plate	Name
225461	10881	Tension Bracket with 201499B ....
200082D	10881	" " " Screw .....
228026	10884	" " " Washer .....
2102	10881	" Disc .....
202407	10881	" Spring .....
201499B	10881	" Stud .....
201572B	10881	" " Thumb Nut .....
225462	10881	Bobbin Winder Tension Bracket complete, Nos. 201572B, 202407, 225461 and two 2102 .....
225433	10885	Bobbin Winder and Tension Bracket Base .....
225382	10885	Universal Bobbin Winder complete, Nos. 200056E, 200082D, 200299H, 202473, 202478, 225381, 225433, 225444, 225453 to 225456, 225458, 225462, 228026, two each 225459 and wood screws ¾ in., No. 12, R.H.B. ....

### KNEE LIFTER

2763	14171	Rock Shaft .....
7539	14171	" " Hanger (back) with two wood screws 1 in., No. 10 .....
20093	14171	Rock Shaft Hanger (front) with two wood screws 1 in., No. 10 ..
2765	14171	Rock Shaft Knee Arm .....
2768	---	" " " " 2765 with 2766 and 2767 .....
2766	14171	Rock Shaft Knee Arm Hub with 356c .....
356c	14171	Rock Shaft Knee Arm Hub Set Screw .....
2767	14171	Rock Shaft Knee Plate with 356c..
356c	14171	" " " " Set Screw..
228238	14171	" " Lifting Lever with 356c
228239	---	" " " " 228238 with 8073, 204225, 228240 and 228241 ..
228240	14171	Rock Shaft Lifting Lever Rod (3 in. long) .....
200529c	14171	Rock Shaft Lifting Lever Rod Set Screw .....
228241	14171	Rock Shaft Lifting Lever Rod Swivel with 200529c .....

No.	Plate	Name
204225	14171	Rock Shaft Lifting Lever Rod Swivel Spring .....
8073	14171	Rock Shaft Lifting Lever Rod Swivel Spring Plunger .....
356c	14171	Rock Shaft Lifting Lever Set Screw
2770	14171	" " Stop Dog with 356c ...
356c	14171	" " " " Set Screw ..
228242	14171	Rock Shaft complete, Nos. 2763, 2768, 7539, 20093, 228239 and two 2770 .....

#### FOR MACHINES NOS. 29w6 AND 29w14

Same as for No. 29w2 with the following exception:

No.	Plate	Name
203470	11284	Bobbin (5), in place of 203208 ....

#### FOR MACHINE No. 29w11

Same as for No. 29w2 with the following exception:

128 x 6	---	Needles, six, size 16 (reverse twist), in place of 128 x 4 .....
---------	-----	--

#### FOR MACHINES NOS. 29w15, 29w21 AND 29w23

Same as for No. 29w2 with the following exception:

207807	10620	Trimmer Knife (3), in place of 207805 .....
--------	-------	---

#### FOR MACHINES NOS. 29w17 AND 29w27

Same as for No. 29w2 with the following exceptions:

203470	11284	Bobbin (5), in place of 203208 ....
207807	10620	Trimmer Knife (3), in place of 207805 .....

## FEED DOGS

No.	Plate	Name
207651	14106	Feed Dog, for 211292, 211420, 211422, 211451 to 211454, 211463 to 211466, 211483, 211484, 211489 to 211503, 211515 to 211525, 211605, 223432 and 223433 .....
211597	14106	Feed Dog, for 211292, 211420, 211422, 211451 to 211454, 211463 to 211466, 211483, 211484, 211489 to 211503, 211515 to 211525, 211605, 223432 and 223433 .....
211255	12024	Feed Dog, for 211421, 211447 to 211450, 211481 and 211482 .....
211256	12024	Feed Dog, for 211421, 211448 to 211450, 211481 and 211482 .....

## FEED WHEELS

204303	11288	Feed Wheel, for 204425, 211292, 211420, 211422, 211451 to 211454, 211463 to 211466, 211483, 211484, 211489 to 211503, 211515 to 211525, 211605, 223432 and 223433 .....
204429	11288	Feed Wheel, for 204433, 211245, 211250, 211284 to 211288, 211455 to 211462, 211485, 211486 and 211973

## ROLLER PRESSERS

No.	Plate	Name
201907	11293	Roller Presser, 1 $\frac{1}{4}$ in. diam., $\frac{5}{8}$ in. face (fine), with 200548c and 201534u .....
201910	11293	Roller Presser, 1 $\frac{1}{4}$ in. diam., $\frac{1}{2}$ in. face (coarse) with 200551c and 201534u .....
208497	11293	Roller Presser Arm .....
208498	---	" " " 208497 with 201910 .....
202839	11293	Roller Presser Arm .....
204569	11293	" " " 202839 with 201907 .....
202560	11293	Roller Presser Arm Bracket (swing) .....
208499	---	" " " " 202560 with 200096D and 208498 .....
204436	---	Roller Presser Arm Bracket 202560 with 200096D and 204569 .....
200675F	11293	Roller Presser Arm Bracket Position Screw Stud .....
202558	11293	Roller Presser Arm Bracket Spring .....
202559	11293	" " " " " " Stop .....
200141F	11293	Roller Presser Arm Bracket Spring Stop Screw .....
200096D	11293	Roller Presser Arm Screw .....
204495	11289	" " Bar .....
200551c	11293	" " Hinge Screw .....
200548c	11293	" " " " " " .....
201534u	11293	" " " " " Nut .....
204576	---	Roller Presser and Bar complete, Nos. 200675F, 202558, 202559, 204495, 208499 and two 200141F, for Machines Nos. 29w2, 29w6 and 29w14 .....
204437	---	Roller Presser and Bar complete, Nos. 200675F, 202558, 202559, 204436, 204495 and two 200141F, for Machines Nos. 29w11, 29w15, 29w17, 21w21, 29w23 and 29w27..

## THROAT PLATES

FOR VERTICAL TRIMMER MACHINE No. 29w2

No.	Plate	Name
211424	12024	Throat Plate Knife Follower .....
200587D	14103	" " " " Screw ..
211416	12024	" " " " Spring ..
200178D	14103	" " " " " " Screw .....
211451	12058	Throat Plate, 60 needle hole, for needle sizes 8 and 9, with 200178D, 200587D, 211416 and 211424, trims opposite the needle and .028, .035, .045, .060 and .085 in. to right of seam, for 204303, 207651 and 211597 .....
211452	12058	Throat Plate, 56 needle hole, for needle sizes 10 and 11, with 200178D, 200587D, 211416 and 211424, trims opposite the needle and .035, .045, .060 and .085 in. to right of seam, for 204303, 207651 and 211597 .....
211453	12058	Throat Plate, 53 needle hole, for needle sizes 12 and 13, with 200178D, 200587D, 211416 and 211424, trims opposite the needle and .045, .060 and .085 in. to right of seam, for 204303, 207651 and 211597 .....
211454	12058	Throat Plate, 50 needle hole, for needle sizes 14 and 15, with 200178D, 200587D, 211416 and 211424, trims opposite the needle and .060 and .085 in. to right of seam, for 204303, 207651 and 211597 .....
211292	12058	Throat Plate, 46 needle hole, for needle sizes 16 and 18, with 200178D, 200587D, 211416 and 211424, trims opposite the needle and .060 and .085 in. to right of seam, for 204303, 207651 and 211597 .....

No.	Plate	Name
211455	12058	Throat Plate, 60 needle hole, for needle sizes 8 and 9, with 200178D, 200587D, 211416 and 211424, trims opposite the needle and .028, .035, .045, .060 and .085 in. to right of seam, for 204429 ..
211456	12058	Throat Plate, 56 needle hole, for needle sizes 10 and 11, with 200178D, 200587D, 211416 and 211424, trims opposite the needle and .035, .045, .060 and .085 in. to right of seam, for 204429 ....
211457	12058	Throat Plate, 53 needle hole, for needle sizes 12 and 13, with 200178D, 200587D, 211416 and 211424, trims opposite the needle .045, .060 and .085 in. to right of seam, for 204429 .....
211458	12058	Throat Plate, 50 needle hole, for needle sizes 14 and 15, with 200178D, 200587D, 211416 and 211424, trims opposite the needle and .060 and .085 in. to right of seam, for 204429 .....
		Nos. 211459 to 211462, for glove work
211459	12058	Throat Plate, 60 needle hole, for needle sizes 8 and 9, with 200178D, 200587D, 211416 and 211424, trims opposite the needle and .028, .035, .045, .060 and .085 in. to right of seam, for 204429 ..
211460	12058	Throat Plate, 56 needle hole, for needle sizes 10 and 11, with 200178D, 200587D, 211416 and 211424, trims opposite the needle and .035, .045, .060 and .085 in. to right of seam, for 204429 .....
211461	12058	Throat Plate, 53 needle hole, for needle sizes 12 and 13, with 200178D, 200587D, 211416 and 211424, trims opposite the needle and .045, .060 and .085 in. to right of seam, for 204429 .....
211462	12058	Throat Plate, 50 needle hole, for needle sizes 14 and 15, with 200178D, 200587D, 211416 and 211424, trims opposite the needle and .060 and .085 in. to right of seam, for 204429 .....

## FOR VERTICAL TRIMMER MACHINE No. 29w6

No.	Plate	Name
211422	12064	Throat Plate, 60 needle hole, for needle sizes 8 and 9, with 200178D, 200587D, 211416 and 211424, trims opposite the needle and .028, .035, .045, .060 and .085 in. to right of seam, for 207651 and 211597 .....
211420	12064	Throat Plate, 56 needle hole, for needle sizes 10 and 11, with 200178D, 200587D, 211416 and 211424, trims opposite the needle and .035, .045, .060 and .085 in. to right of seam, for 207651 and 211597 .....
211483	12064	Throat Plate, 53 needle hole, for needle sizes 12 and 13, with 200178D, 200587D, 211416 and 211424, trims opposite the needle and .045, .060 and .085 in. to right of seam, for 207651 and 211597..
211484	12064	Throat Plate, 50 needle hole, for needle sizes 14 and 15, with 200178D, 200587D, 211416 and 211424, trims opposite the needle and .060 and .085 in. to right of seam, for 207651 and 211597 ....
211605	12064	Throat Plate, 46 needle hole, for needle sizes 16 and 18, with 200178D, 200587D, 211416 and 211424, trims opposite the needle and .060 and .085 in. to right of seam, for 207651 and 211597 ....

## FOR VERTICAL TRIMMER MACHINE No. 29w11

211453	12058	Throat Plate, 53 needle hole, for needle sizes 12 and 13, with 200178D, 200587D, 211416 and 211424, trims opposite the needle and .045, .060 and .085 in. to right of seam, for 204303, 207651 and 211597 .....
--------	-------	---



No.	Plate	Name
211454	12058	Throat Plate, 50 needle hole, for needle sizes 14 and 15, with 200178D, 200587D, 211416 and 211424, trims opposite the needle and .060 and .085 in. to right of seam, for 204303, 207651 and 211597 .....
211292	12058	Throat Plate, 46 needle hole, for needle sizes 16 and 18, with 200178D, 200587D, 211416 and 211424, trims opposite the needle and .060 and .085 in. to right of seam, for 204303, 207651 and 211597 .....
211457	12058	Throat Plate, 53 needle hole, for needle sizes 12 and 13, with 200178D, 200587D, 211416 and 211424, trims opposite the needle and .045, .060 and .085 in. to right of seam, for 204429 .....
211458	12058	Throat Plate, 50 needle hole, for needle sizes 14 and 15, with 200178D, 200587D, 211416 and 211424, trims opposite the needle and .060 and .085 in. to right of seam, for 204429 .....
211461	12058	Throat Plate, 53 needle hole, for needle sizes 12 and 13, with 200178D, 200587D, 211416 and 211424, trims opposite the needle and .045, .060 and .085 in. to right of seam, for glove work, for 204429 .....
211462	12058	Throat Plate, 50 needle hole, for needle sizes 14 and 15, with 200178D, 200587D, 211416 and 211424, trims opposite the needle and .060 and .085 in. to right of seam, for glove work, for 204429 .....

**FOR VERTICAL TRIMMER MACHINE No. 29w14**

211422	12064	Throat Plate, 60 needle hole, for needle sizes 8 and 9, with 200178D, 200587D, 211416 and 211424, trims opposite the needle and .028, .035, .045, .060 and .085 in. to right of seam, for 204303..
--------	-------	--

No.	Plate	Name
211420	12061	Throat Plate, 56 needle hole, for needle sizes 10 and 11, with 200178D, 200587D, 211416 and 211424, trims opposite the needle and .035, .045, .060 and .085 in. to right of seam, for 204303 .....
211483	12064	Throat Plate, 53 needle hole, for needle sizes 12 and 13, with 200178D, 200587D, 211416 and 211424, trims opposite the needle and .045, .060 and .085 in. to right of seam, for 204303 .....
211484	12064	Throat Plate, 50 needle hole, for needle sizes 14 and 15, with 200178D, 200587D, 211416 and 211424, trims opposite the needle and .060 and .085 in. to right of seam, for 204303 .....
211605	12061	Throat Plate, 46 needle hole, for needle sizes 16 and 18, with 200178D, 200587D, 211416 and 211424, trims opposite the needle and .060 and .085 in. to right of seam, for 204303 .....
211287	12024	Throat Plate, 60 needle hole, for needle sizes 8 and 9, with 200178D, 200587D, 211416 and 211424, trims opposite the needle and .028, .035, .045, .060 and .085 in. to right of seam, for 204429 ..
211245	12024	Throat Plate, 56 elongated needle hole, for needle sizes 12 and 13, with 200178D, 200587D, 211416 and 211424, trims opposite the needle and .035, .045, .060 and .085 in. to right of seam, for 204429 ....
211284	12024	Throat Plate, 53 elongated needle hole, for needle sizes 14 and 15, with 200178D, 200587D, 211416 and 211424, trims opposite the needle and .045, .060 and .085 in. to right of seam, for 204429 .....
211288	12024	Throat Plate, 50 elongated needle hole, for needle sizes 16 and 18, with 200178D, 200587D, 211416 and 211424, trims opposite the needle and .060 and .085 in. to right of seam, for 204429 .....

## Throat Plates

No.	Plate	Name
211250	12024	Throat Plate, 46 elongated needle hole, for needle sizes 20 and 22, with 200178D, 200587D, 211416 and 211424, trims opposite the needle and .060 and .085 in. to right of seam, for 204429 .....
211485	12064	Throat Plate, 60 needle hole, for needle sizes 8 and 9, with 200178D, 200587D, 211416 and 211424, trims opposite the needle and .028, .035, .045, .060 and .085 in. to right of seam, for glove work, for 204429 .....
211486	12064	Throat Plate, 56 needle hole, for needle sizes 10 and 11, with 200178D, 200587D, 211416 and 211424, trims opposite the needle and .035, .045, .060 and .085 in. to right of seam, for glove work, for 204429 .....
211285	12064	Throat Plate, 53 elongated needle hole, for needle sizes 14 and 15, with 200178D, 200587D, 211416 and 211424, trims opposite the needle and .045, .060 and .085 in. to right of seam, for glove work, for 204429 .....
211973	12064	Throat Plate, 50 needle hole, for needle sizes 14 and 15, with 200178D, 200587D, 211416 and 211424, trims opposite the needle and .060 and .085 in. to right of seam, for 204429 .....
211286	12064	Throat Plate, 46 elongated needle hole, for needle sizes 20 and 22, with 200178D, 200587D, 211416 and 211424, trims opposite the needle and .060 and .085 in. to right of seam, for glove work, for 204429 .....

## FOR UNDEREDGE TRIMMER MACHINE No. 29w15

211465	12059	Throat Plate, 53 needle hole, for needle sizes 12 and 13, with 200178D, 200587D, 211416 and 211540, trims opposite the needle and .040, .050, .060, .075 and .085 in. to right of seam, for 204303, 207651 and 211597 .....
--------	-------	---

## Throat Plates

No.	Plate	Name
211466	12059	Throat Plate, 50 needle hole, for needle sizes 14 and 15, with 200178D, 200587D, 211416 and 211540, trims opposite the needle and .050, .060, .075 and .085 in. to right of seam, for 204303, 207651 and 211597 .....
223444	14106	Throat Plate Body, for trimming opposite the needle and .035, .040 or .050 in. to right of seam, for 211499 to 211501 and 223433 ....
211468	12059	Throat Plate Body, for trimming opposite the needle and .060 or .075 in. to right of seam, for 211502 and 211503 .....
211540	14106	Throat Plate Knife Follower .....
207487	12069	" " " Cutting Bar, 56 needle hole, for needle sizes 10 and 11, trims opposite the needle and .035 in. to right of seam ....
223433	11299	Throat Plate complete, 56 needle hole, for needle sizes 10 and 11, trims opposite the needle and .035 in. to right of seam, Nos. 207487, 223444 and two 200583H, for 204303, 207651 and 211597 ..
207470	12069	Throat Plate Knife Cutting Bar, 53 needle hole, for needle sizes 12 and 13, trims opposite the needle and .040 in. to right of seam ....
200583H	14107	Throat Plate Knife Cutting Bar Screw .....
211499	12061	Throat Plate complete, 53 needle hole, for needle sizes 12 and 13, trims opposite the needle and .040 in. to right of seam, Nos. 207470, 223444 and two 200583H, for 204303, 207651 and 211597 .....
208496	14107	Throat Plate Knife Cutting Bar, 53 needle hole, for needle sizes 12 and 13, trims opposite the needle and .050 in. to right of seam ....
211500	12061	Throat Plate complete, 53 needle hole, for needle sizes 12 and 13, trims opposite the needle and .050 in. to right of seam, Nos. 208496, 223444 and two 200583H, for 204303, 207651 and 211597 .....

## Throat Plates

No.	Plate	Name
207463	12060	Throat Plate Knife Cutting Bar, 50 needle hole, for needle sizes 14 and 15, trims opposite the needle and .050 in. to right of seam ....
211501	12061	Throat Plate complete, 50 needle hole, for needle sizes 14 and 15, trims opposite the needle and .050 in. to right of seam. Nos. 207463, 223444 and two 200583u, for 202403, 207651 and 211597 .....
207474	12060	Throat Plate Knife Cutting Bar, 50 needle hole, for needle sizes 14 and 15, trims opposite the needle and .060 in. to right of seam ....
211502	12061	Throat Plate complete, 50 needle hole, for needle sizes 14 and 15, trims opposite the needle and .060 in. to right of seam. Nos. 207474, 211468 and two 200583u, for 204303, 207651 and 211597 .....
207475	12060	Throat Plate Knife Cutting Bar, 50 needle hole, for needle sizes 14 and 15, trims opposite the needle and .075 in. to right of seam ....
211503	12061	Throat Plate complete, 50 needle hole, for needle sizes 14 and 15, trims opposite the needle and .075 in. to right of seam. Nos. 207475, 211468 and two 200583u, for 204303, 207651 and 211597 .....

## FOR UNDEREDGE TRIMMER MACHINE No. 29w17

211491	12066	Throat Plate, 53 needle hole, for needle sizes 12 and 13, with 200178D, 200587D, 211416 and 211540, trims opposite the needle and .040, .050, .060, .075 and .085 in. to right of seam, for 204303, 207651 and 211597 .....
211492	12066	Throat Plate, 50 needle hole, for needle sizes 14 and 15, with 200178D, 200587D, 211416 and 211540, trims opposite the needle and .050, .060, .075 and .085 in. to right of seam, for 204303, 207651 and 211597 .....

## Throat Plates

No.	Plate	Name
211488	12065	Throat Plate Body, for trimming opposite the needle and .060 or .075 in. to right of seam, for 211524 and 211525 .....
223446	14106	Throat Plate Body, for trimming opposite the needle and .035, .040 or .050 in. to right of seam, for 211521 to 211523 and 223432 ....
207487	12060	Throat Plate Knife Cutting Bar, 56 needle hole, for needle sizes 10 and 11, trims opposite the needle and .035 in. to right of seam ....
207470	12060	Throat Plate Knife Cutting Bar, 53 needle hole, for needle sizes 12 and 13, trims opposite the needle and .040 in. to right of seam ....
223432	11299	Throat Plate complete, 56 needle hole, for needle sizes 10 and 11, trims opposite the needle and .035 in. to right of seam. Nos. 207487, 223446 and two 200583u, for 204303, 207651 and 211597 .....
211521	12065	Throat Plate complete, 53 needle hole, for needle sizes 12 and 13, trims opposite the needle and .040 in. to right of seam. Nos. 207470, 223446 and two 200583u, for 204303, 207651 and 211597 .....
211522	12065	Throat Plate complete, 53 needle hole, for needle sizes 12 and 13, trims opposite the needle and .050 in. to right of seam. Nos. 208496, 223446 and two 200583u, for 204303, 207651 and 211597 .....
208496	14107	Throat Plate Knife Cutting Bar, 53 needle hole, for needle sizes 12 and 13, trims opposite the needle and .050 in. to right of seam ..
207463	12060	Throat Plate Knife Cutting Bar, 50 needle hole, for needle sizes 14 and 15, trims opposite the needle and .050 in. to right of seam ....
211523	12065	Throat Plate complete, 50 needle hole, for needle sizes 14 and 15, trims opposite the needle and .050 in. to right of seam. Nos. 207463, 223446 and two 200583u, for 204303, 207651 and 211597 .....

No.	Plate	Name
207474	12060	Throat Plate Knife Cutting Bar, 50 needle hole, for needle sizes 14 and 15, trims opposite the needle and .060 in. to right of seam . . . .
211524	12065	Throat Plate complete, 50 needle hole, for needle sizes 14 and 15, trims opposite the needle and .060 in. to right of seam, Nos. 207474, 211488 and two 200583u, for 204303, 207651 and 211597 . . . . .
207475	12060	Throat Plate Knife Cutting Bar, 50 needle hole, for needle sizes 14 and 15, trims opposite the needle and .075 in. to right of seam . . . .
211525	12065	Throat Plate complete, 50 needle hole, for needle sizes 14 and 15, trims opposite the needle and .075 in. to right of seam, Nos. 207475, 211488 and two 200583u, for 204303, 207651 and 211597 . . . . .

**FOR UNDEREDGE TRIMMER MACHINES  
NOS. 29w21 AND 29w23**

211463	12058	Throat Plate, 53 needle hole, for needle sizes 12 and 13, with 200178D, 200587D, 211416 and 211425, trims back of needle and .015, .025, .035 and .050 in. to right of seam, for 204303, 207651 and 211597 . . . . .
211464	12058	Throat Plate, 50 needle hole, for needle sizes 14 and 15, with 200178D, 200587D, 211416 and 211425, trims back of needle and .015, .025, .035 and .050 in. to right of seam, for 204303, 207651 and 211597 . . . . .
223443	14106	Throat Plate Body, for trimming back of needle and .015 or .025 in. to right of seam, for 211493 to 211496 . . . . .
211467	12059	Throat Plate Body, for trimming back of needle and .035 or .050 in. to right of seam, for 211497 and 211498 . . . . .
211425	12058	Throat Plate Knife Follower . . . .

No.	Plate	Name
207464	12059	Throat Plate Knife Cutting Bar, 53 needle hole, for needle sizes 12 and 13, trims back of needle and .015 in. to right of seam . . . . .
211493	12061	Throat Plate complete, 53 needle hole, for needle sizes 12 and 13, trims back of needle and .015 in. to right of seam, Nos. 207464, 223443 and two 200583u, for 204303, 207651 and 211597 . . . . .
207299	12059	Throat Plate Knife Cutting Bar, 50 needle hole, for needle sizes 14 and 15, trims back of needle and .015 in. to right of seam . . . . .
211494	12061	Throat Plate complete, 50 needle hole, for needle sizes 14 and 15, trims back of needle and .015 in. to right of seam, Nos. 207299, 223443 and two 200583u, for 204303, 207651 and 211597 . . . . .
207471	12059	Throat Plate Knife Cutting Bar, 53 needle hole, for needle sizes 12 and 13, trims back of needle and .025 in. to right of seam . . . . .
211495	12061	Throat Plate complete, 53 needle hole, for needle sizes 12 and 13, trims back of needle and .025 in. to right of seam, Nos. 207471, 223443 and two 200583u, for 204303, 207651 and 211597 . . . . .
207300	12059	Throat Plate Knife Cutting Bar, 50 needle hole, for needle sizes 14 and 15, trims back of needle and .025 in. to right of seam . . . . .
211496	12061	Throat Plate complete, 50 needle hole, for needle sizes 14 and 15, trims back of needle and .025 in. to right of seam, Nos. 207300, 223443 and two 200583u, for 204303, 207651 and 211597 . . . . .
207472	12060	Throat Plate Knife Cutting Bar, 50 needle hole, for needle sizes 14 and 15, trims back of needle and .035 in. to right of seam . . . . .
211497	12061	Throat Plate complete, 50 needle hole, for needle sizes 14 and 15, trims back of needle and .035 in. to right of seam, Nos. 207472, 211467 and two 200583u, for 204303, 207651 and 211597 . . . . .

## Throat Plates

No.	Plate	Name
207473	12060	Throat Plate Knife Cutting Bar, 50 needle hole, for needle sizes 14 and 15, trims back of needle and .050 in. to right of seam .....
211498	12061	Throat Plate complete, 50 needle hole, for needle sizes 14 and 15, trims back of needle and .050 in. to right of seam, Nos. 207473, 211467 and two 200583u, for 204303, 207651 and 211597 .....

## FOR UNDEREDGE TRIMMER MACHINE No. 29w27

211489	12066	Throat Plate, 53 needle hole, for needle sizes 12 and 13, with 200178D, 200587D, 211416 and 211425, trims back of needle and .015, .025, .035 and .050 in. to right of seam, for 204303, 207651 and 211597 .....
211490	12066	Throat Plate, 50 needle hole, for needle sizes 14 and 15, with 200178D, 200587D, 211416 and 211425, trims back of needle and .015, .025, .035 and .050 in. to right of seam, for 204303, 207651 and 211597 .....
211487	12065	Throat Plate Body, for trimming back of needle and .035 or .050 in. to right of seam, for 211519 and 211520 .....
223445	14106	Throat Plate Body, for trimming back of needle and .015 or .025 in. to right of seam, for 211515 to 211518 .....
207464	12059	Throat Plate Knife Cutting Bar, 53 needle hole, for needle sizes 12 and 13, trims back of needle and .015 in. to right of seam .....
211515	12065	Throat Plate complete, 53 needle hole, for needle sizes 12 and 13, trims back of needle and .015 in. to right of seam, Nos. 207464, 223445 and two 200583u, for 204303, 207651 and 211597 .....
207299	12059	Throat Plate Knife Cutting Bar, 50 needle hole, for needle sizes 14 and 15, trims back of needle and .015 in. to right of seam .....

## Throat Plates

No.	Plate	Name
211516	12065	Throat Plate complete, 50 needle hole, for needle sizes 14 and 15, trims back of needle and .015 in. to right of seam, Nos. 207299, 223445 and two 200583u, for 204303, 207651 and 211597 .....
207471	12059	Throat Plate Knife Cutting Bar, 53 needle hole, for needle sizes 12 and 13, trims back of needle and .025 in. to right of seam .....
211517	12065	Throat Plate complete, 53 needle hole, for needle sizes 12 and 13, trims back of needle and .025 in. to right of seam, Nos. 207471, 223445 and two 200583u, for 204303, 207651 and 211597 .....
207300	12059	Throat Plate Knife Cutting Bar, 50 needle hole, for needle sizes 14 and 15, trims back of needle and .025 in. to right of seam .....
211518	12065	Throat Plate complete, 50 needle hole, for needle sizes 14 and 15, trims back of needle and .025 in. to right of seam, Nos. 207300, 223445 and two 200583u, for 204303, 207651 and 211597 .....
207472	12060	Throat Plate Knife Cutting Bar, 50 needle hole, for needle sizes 14 and 15, trims back of needle and .035 in. to right of seam .....
211519	12065	Throat Plate complete, 50 needle hole, for needle sizes 14 and 15, trims back of needle and .035 in. to right of seam, Nos. 207472, 211487 and two 200583u, for 204303, 207651 and 211597 .....
207473	12060	Throat Plate Knife Cutting Bar, 50 needle hole, for needle sizes 14 and 15, trims back of needle and .050 in. to right of seam .....
211520	12065	Throat Plate complete, 50 needle hole, for needle sizes 14 and 15, trims back of needle and .050 in. to right of seam, Nos. 207473, 211487 and two 200583u, for 204303, 207651 and 211597 .....

## KNIFE GRINDER

No.	Plate	Name
206977	----	Emery Wheel, 2 in. diameter ....
206962	11296	" " Driving Shaft .....
201510D	11296	" " " " Nut
204101	11296	" " " " "
		Washer .....
206963	11296	Emery Wheel Driving Shaft Pulley with two 200403c .....
200403c	14103	Emery Wheel Driving Shaft Pulley Set Screw .....
244040	11296	Emery Wheel Guard .....
200054E	11296	" " " Screw .....
206969	11296	" " Washer (paper) ....
206964	----	Knife Grinder Frame with two 54897 .....
54897	14101	Knife Grinder Frame Oil Cup ....
207029	11296	" Holder Slide Bracket with 200394c, 200457D and 201168D ...
200457D	11296	Knife Holder Slide Bracket Adjust- ing Screw .....
206966	11296	Knife Holder Slide Bracket Adjust- ing Screw Slide Plate .....
200577H	10473	Knife Holder Slide Bracket Adjust- ing Screw Slide Plate Screw ....
200394c	11296	Knife Holder Slide Bracket Set Screw .....
206967	11296	Knife Holder Slide Bracket Shaft
207031	11296	" " " " "
		Collar with 200473B .....
200473B	11296	Knife Holder Slide Bracket Shaft Collar Thumb Screw .....
201168D	11296	Knife Set Screw .....
207032	11296	Knife Grinder complete, Nos. 200577H, 201510D, 204101, 206962 to 206964, 206966, 206967, 206977, 207029, 207031, 244040, two each 200054E and 206969 .....

## KNIVES

No.	Plate	Name
207801	10620	Knife .....
207802	10620	" .....
207803	10620	" .....
207803	10620	" .....
207804	10620	" .....
207805	10620	" .....
207806	10620	" .....
207807	10620	" .....
207808	10620	" .....

## OBSOLETE PARTS

202470	12320	Bobbin Winder Base .....
202471	12320	" " Frame .....
202472	12319	" " " Spring .....
202474	12320	" " Spindle .....
227522	12319	" " Stop Latch .....
202477	12319	" " " Thumb Lever .....
202480	12320	Bobbin Winder Spool Holder Base with 200355H and 202484 .....
202481	12320	Bobbin Winder Spool Holder Base Spool Pin .....
202482	12319	Bobbin Winder Spool Holder Ten- sion Disc (lower or upper) .....
202483	12319	Bobbin Winder Spool Holder Ten- sion Disc Spring (brass) .....
202484	12319	Bobbin Winder Spool Holder Ten- sion Disc Thread Guide .....
202485	12320	Bobbin Winder Spool Holder com- plete, Nos. 200011D, 202480, 202481, 202483, two 202482 and one wood screw 1 in., No. 13 .....

No.	Plate	Name
227522	12319	Bobbin Winder Stop Latch .....
227523	12320	Bobbin Winder complete, Nos. 200056e, 200161b, 200221b, 201537u, 202470 to 202474, 202477, 204278, 227522, three 200299u and two round head wood screws $\frac{3}{4}$ in., No. 12 .....
213145	11281	Face Plate with 200366u, 200368u, 202087, 202090, 204185 and two 200397u .....
213653	11281	Face Plate complete, Nos. 200122u, 200319c, 200577u, 202088, 204059, 204272, 204280, 213145, 213164 and 213165 .....
213148	11282	Feed Driving Eccentric (adjustable) .....
213149	11282	Feed Driving Eccentric Adjusting Disc .....
204306	14512	Feed Wheel Driver with 204189, 204307 and 204311 .....
213867	---	Feed Wheel Driver 204306 with 200263e, 201528e and 213866, for Machines Nos. 29w14 and 29w21 .....
204307	11286	Feed Wheel Driver Clutch .....
213864	11286	" " " Crank with two 200383c .....
213865	11286	Feed Wheel Driver Crank Lever (auxiliary) .....
213866	----	Feed Wheel Driver Crank Lever 213865 with 204310, 213864 and two 200266b .....
203250	11007	Hook Driving Shaft Collar with two 200393c .....
227449	14108	Knee Lifter Lifting Lever .....
213182	11059	Knife Bar Collar with 200078e and two 200387c, for Machines Nos. 29w15, 29w17, 29w21, 29w23 and 29w27 .....
213185	11059	Knife Bar Collar Extension, for Machines Nos. 29w15, 29w17, 29w21, 29w23 and 29w27 .....
213183	11059	Knife Bar Handle (switch-in) .....
213184	11059	" " " Bracket with 200263e and 201528b .....
213180	11059	Knife Bar Handle Spring .....
213778	---	" " Position Guide 204373 with 213180, 213183, 213184 and two 200577u, for Machines Nos. 29w15, 29w17, 29w21, 29w23 and 29w27 .....

No.	Plate	Name
213164	11052	Tension Release Lever .....
213165	11052	" " " Spring .....
213156	11052	" " Slide with 204269 .....
204269	11292	" " " Spring, for 213156 .....
211426	12024	Throat Plate Knife Follower .....
211448	12024	" " 56 needle hole, for needle sizes 10 and 11, with 200178b, 200587b, 211416 and 211426, trims opposite the needle and .035, .045, .060 and .085 in. to right of seam, for 211255 and 211256, for Machine No. 29w2 .....
211449	12024	Throat Plate, 53 needle hole, for needle sizes 12 and 13, with 200178b, 200587b, 211416 and 211426, trims opposite the needle and .045, .060 and .085 in. to right of seam, for 211255 and 211256, for Machine No. 29w2 .....
211450	12024	Throat Plate, 50 needle hole, for needle sizes 14 and 15, with 200178b, 200587b, 211416 and 211426, trims opposite the needle and .060 and .085 in. to right of seam, for Machine No. 29w2 .....
211421	12064	Throat Plate, 56 needle hole, for needle sizes 10 and 11, with 200178b, 200587b, 211416 and 211426, trims opposite the needle and .035, .045, .060 and .085 in. to right of seam, for 211255 and 211256, for Machine No. 29w6 .....
211481	12064	Throat Plate, 53 needle hole, for needle sizes 12 and 13, with 200178b, 200587b, 211416 and 211426, trims opposite the needle and .045, .060 and .085 in. to right of seam, for 211255 and 211256, for Machine No. 29w6 .....
211482	12064	Throat Plate, 50 needle hole, for needle sizes 14 and 15, with 200178b, 200587b, 211416 and 211426, trims opposite the needle and .060 and .085 in. to right of seam, for 211255 and 211256, for Machine No. 29w6 .....

PLATE 10473—FULL SIZE

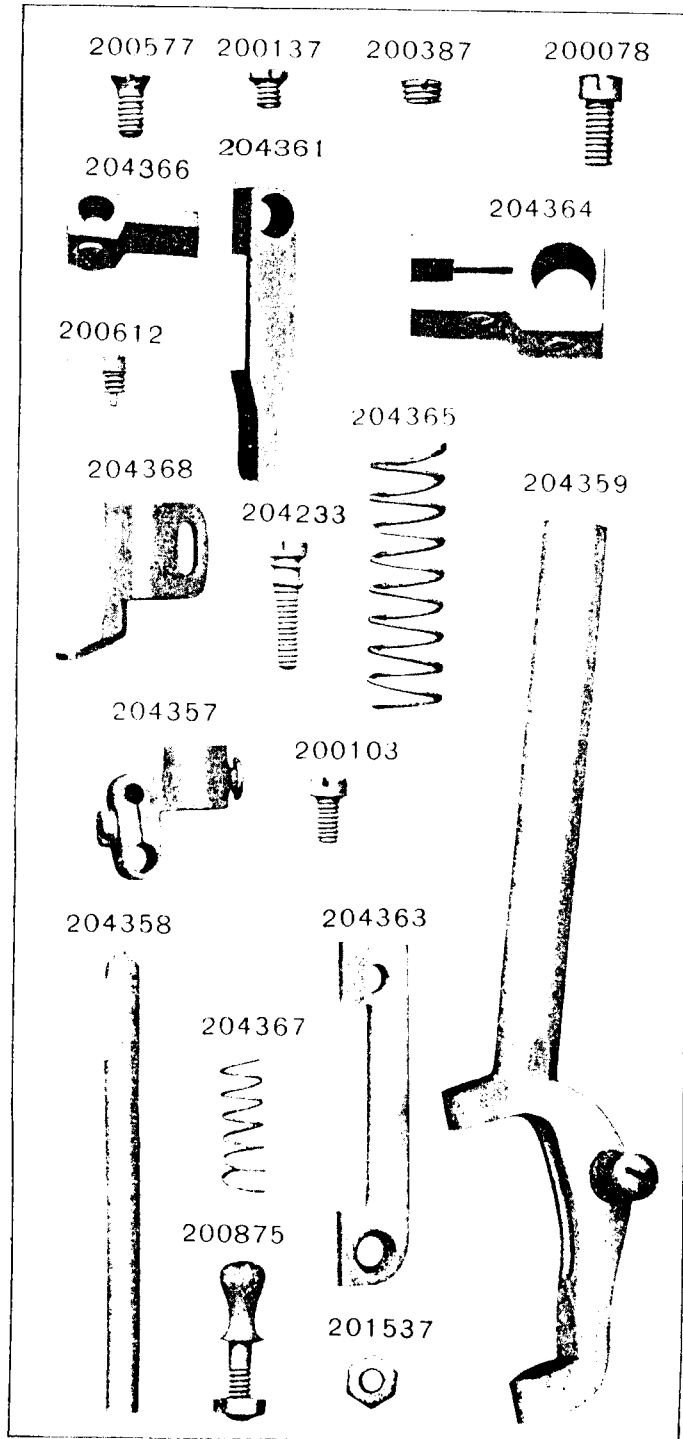
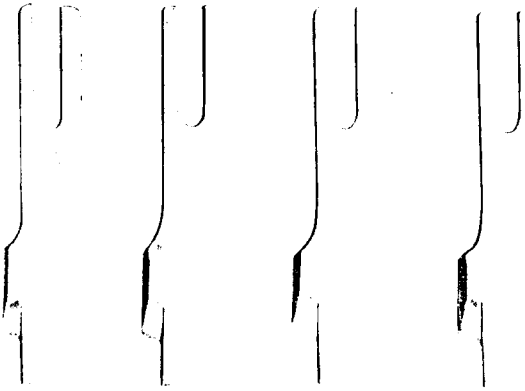




PLATE 10620—FULL SIZE

207801 207802 207803 207804



207805 207806 207807 207808

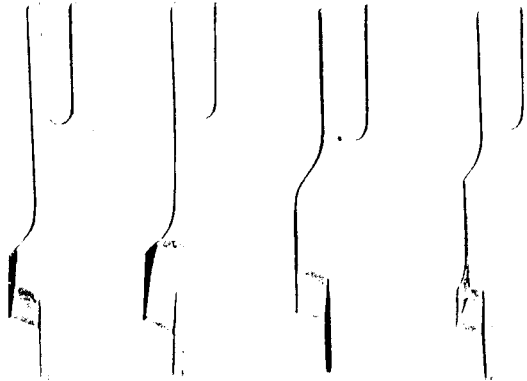
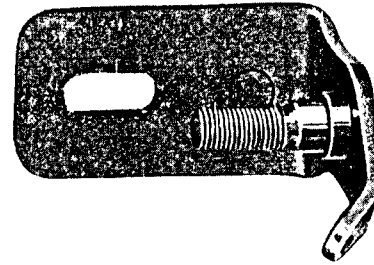


PLATE 10881—FULL SIZE

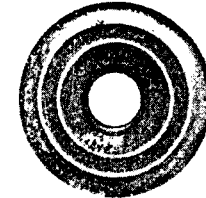
225461



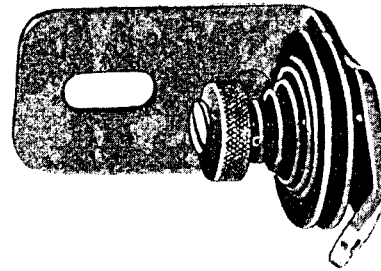
200082 202104



2102



225462



202407



201499



201572

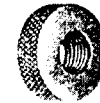


PLATE 10884—FULL SIZE

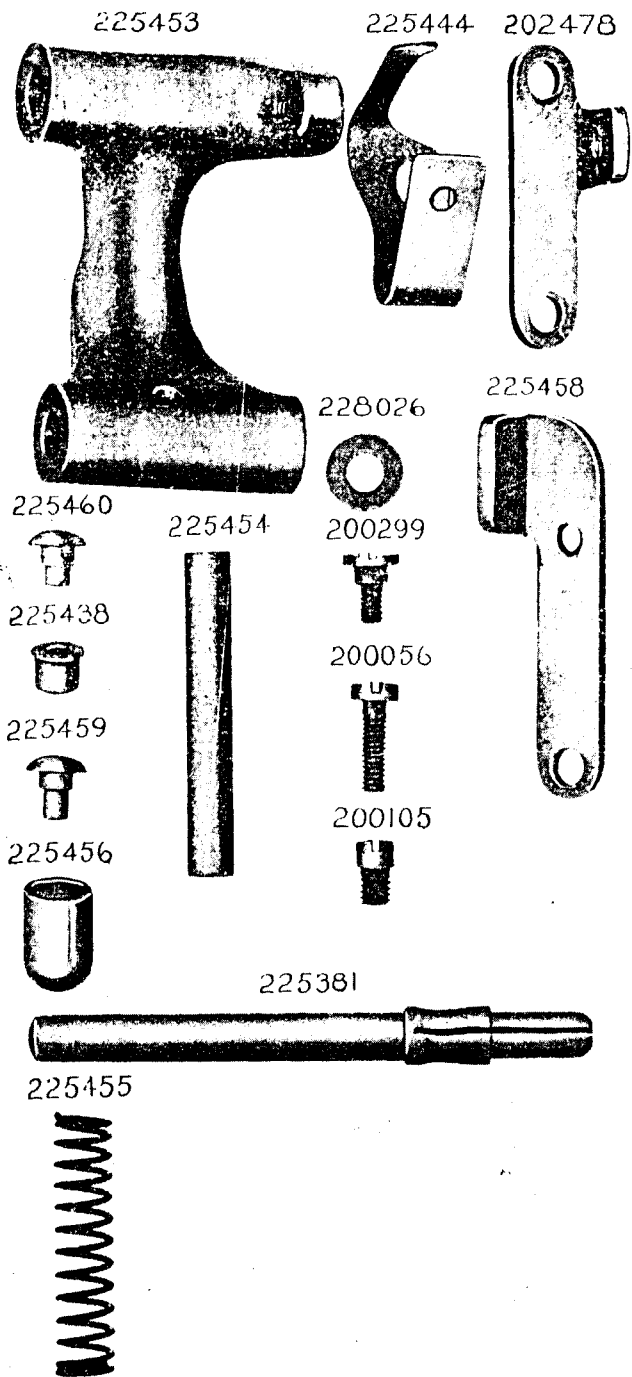


PLATE 10885—ONE-FOURTH SIZE

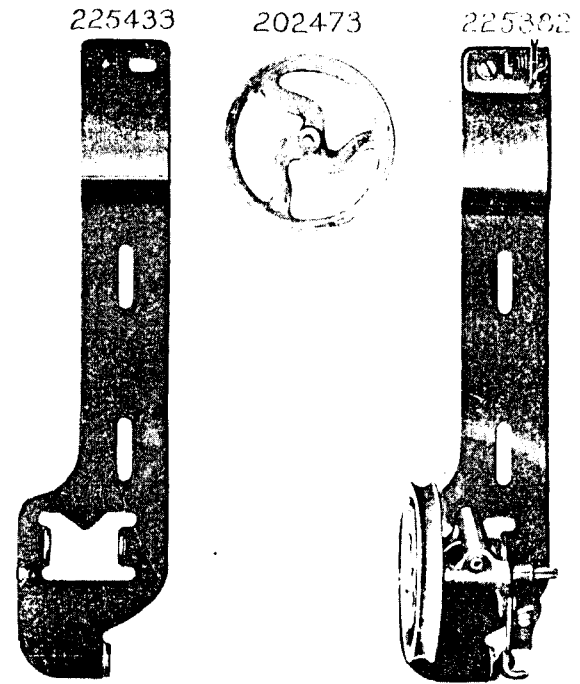
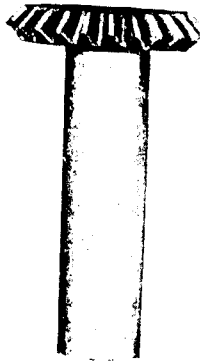


PLATE 11007—FULL SIZE

203241



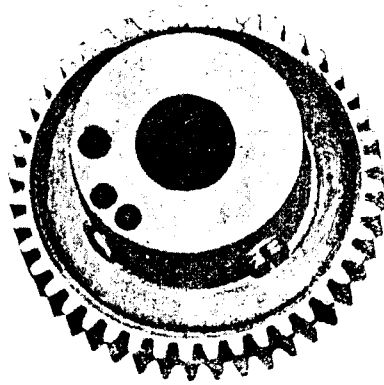
200555



203242



203245



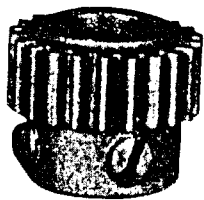
203250



200393

ES

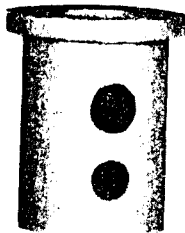
203246



200006



203249



225585



203244



200840



PLATE 11048—FULL SIZE

200338



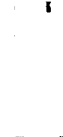
200038



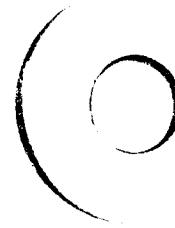
200545



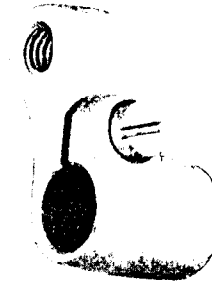
200641



213654



202298



200244



200245



200665



213655



213161

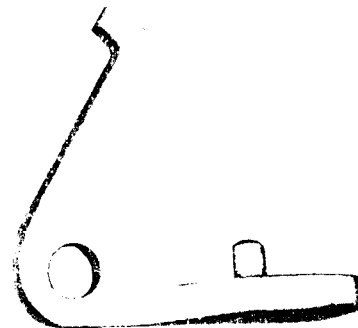


PLATE 11052—FULL SIZE

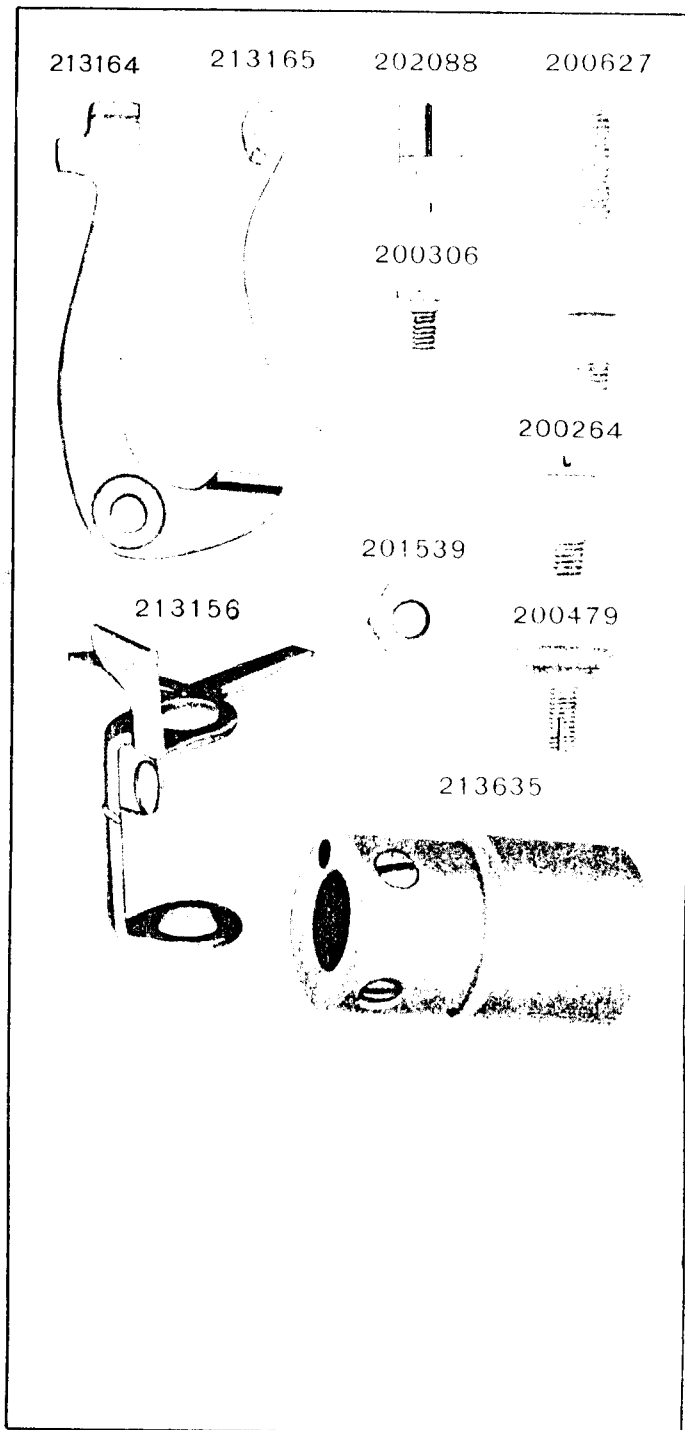


PLATE 11059—FULL SIZE

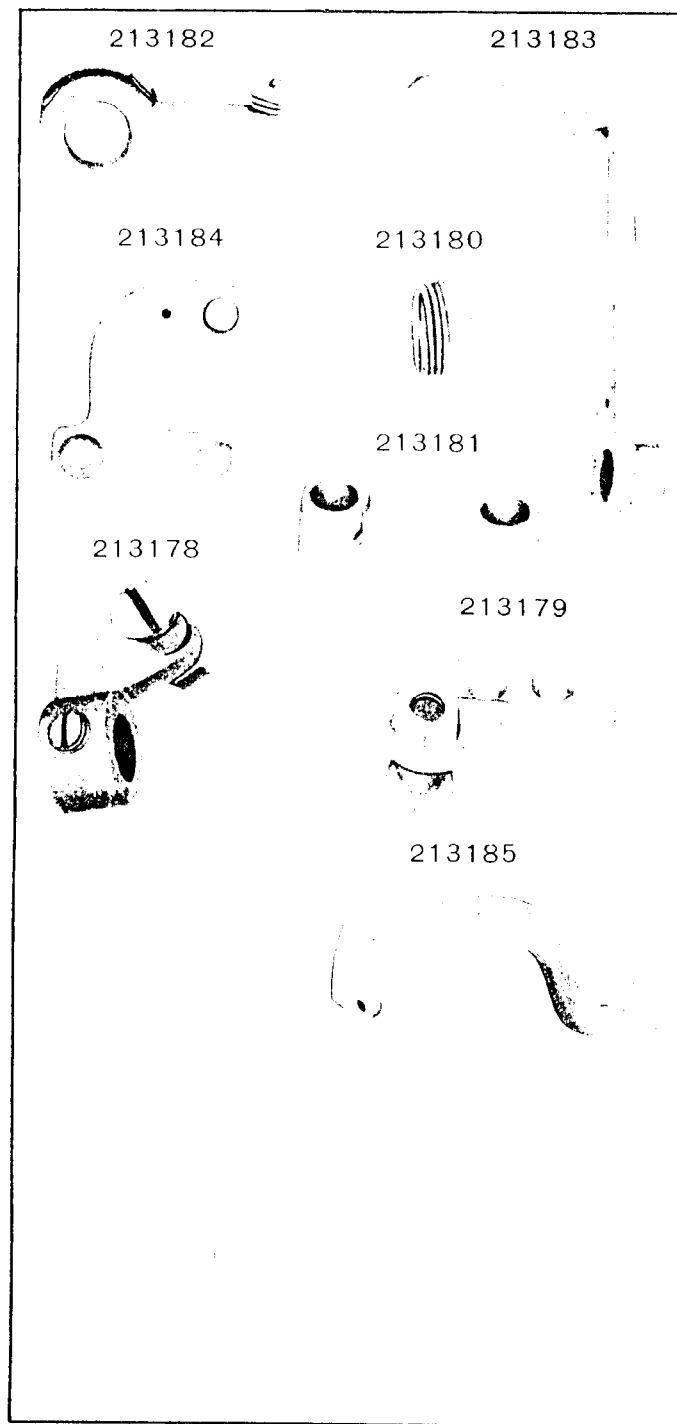


PLATE 11241—FULL SIZE

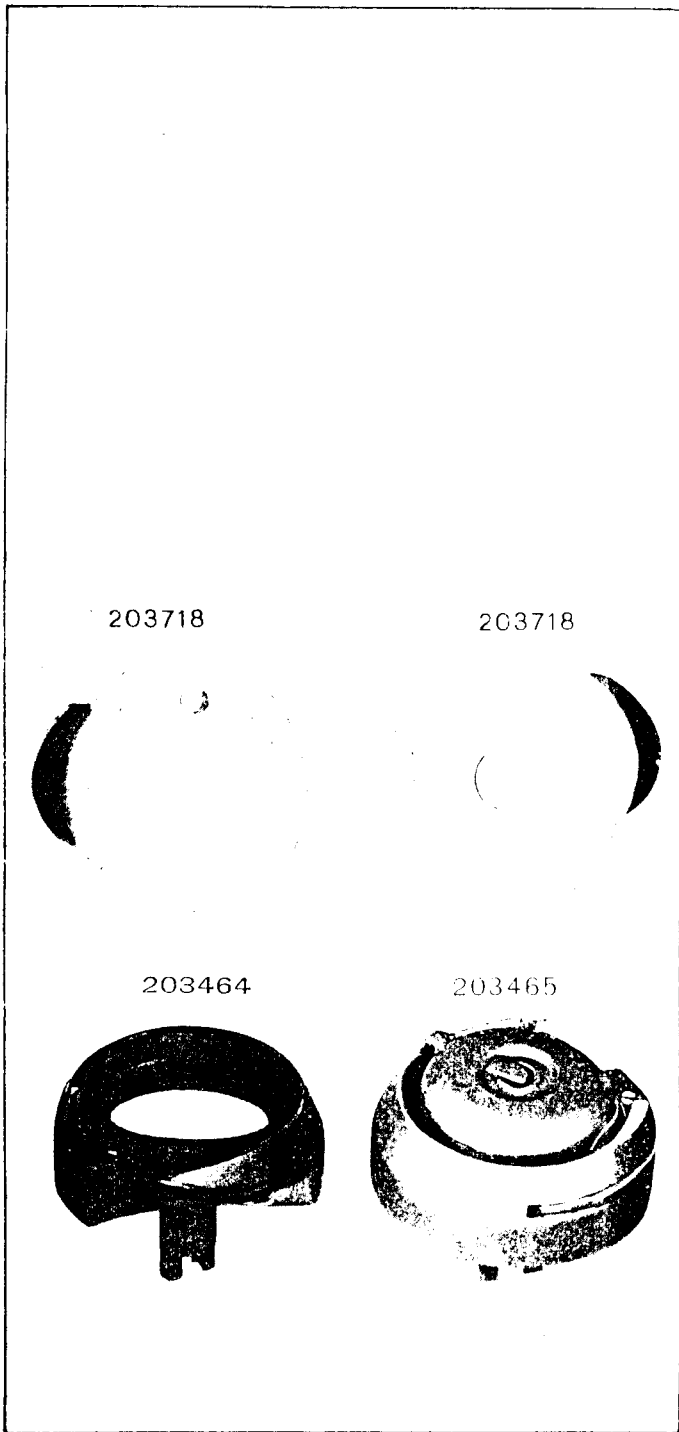


PLATE 11281—ONE-FOURTH SIZE

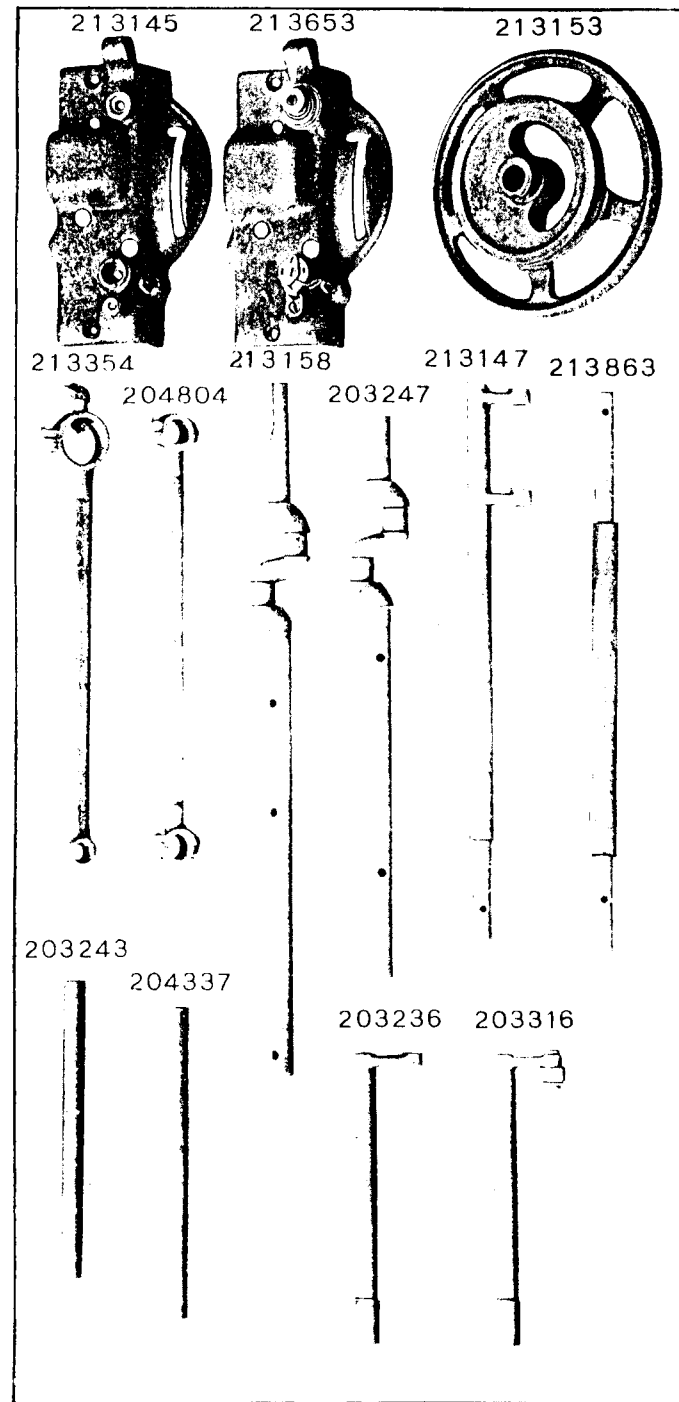


PLATE 11282-ONE-HALF SIZE

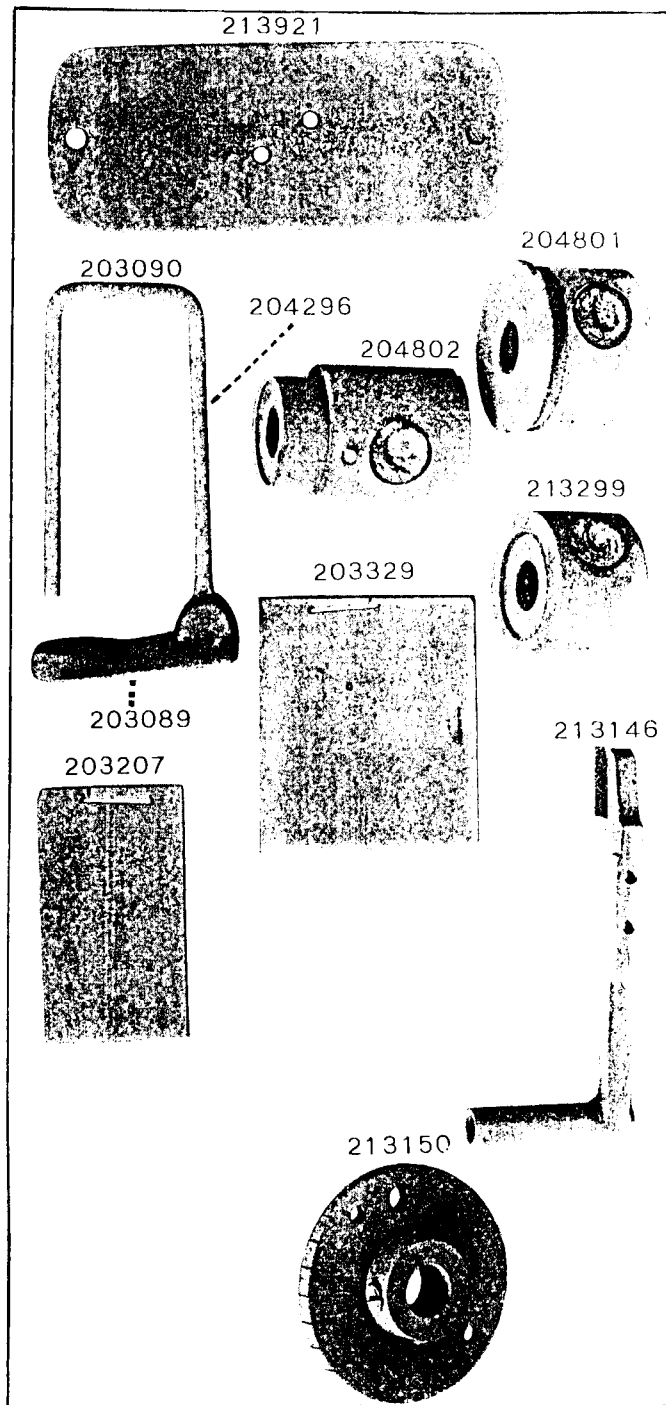


PLATE 11283-ONE-HALF SIZE

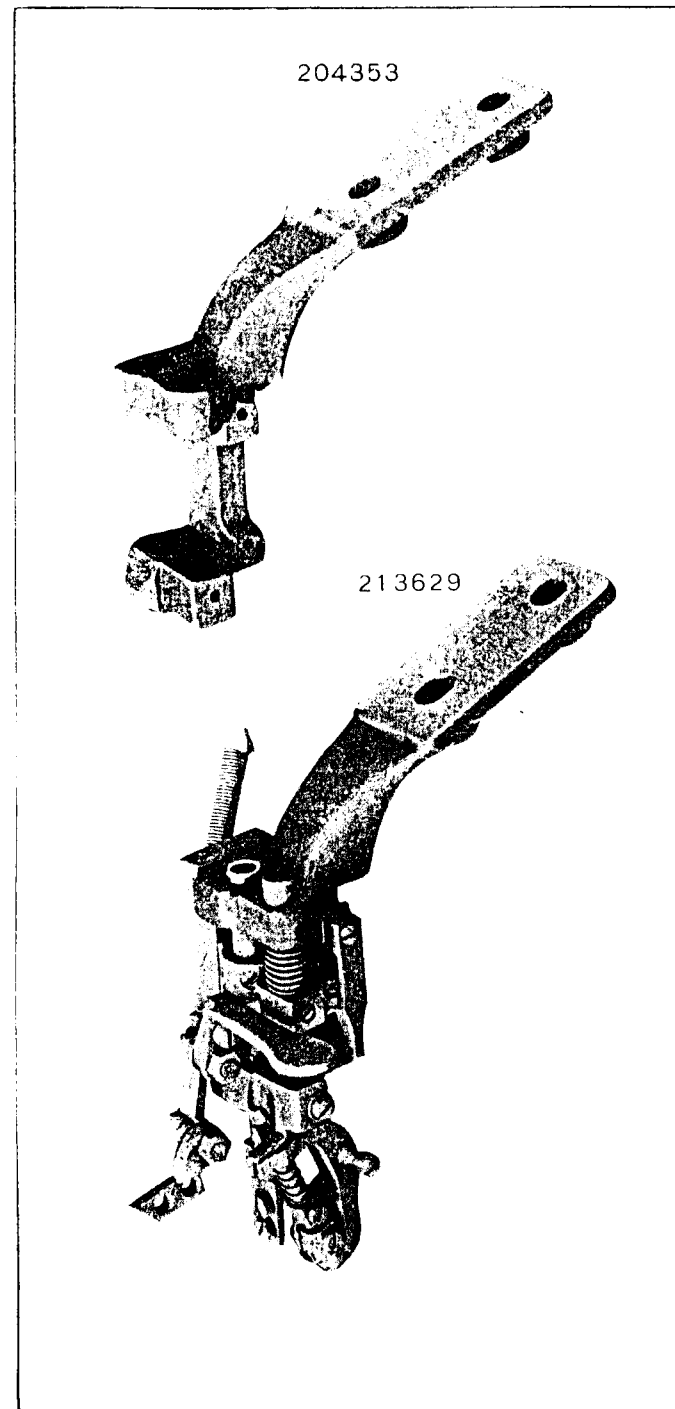


PLATE 11284 - FULL SIZE

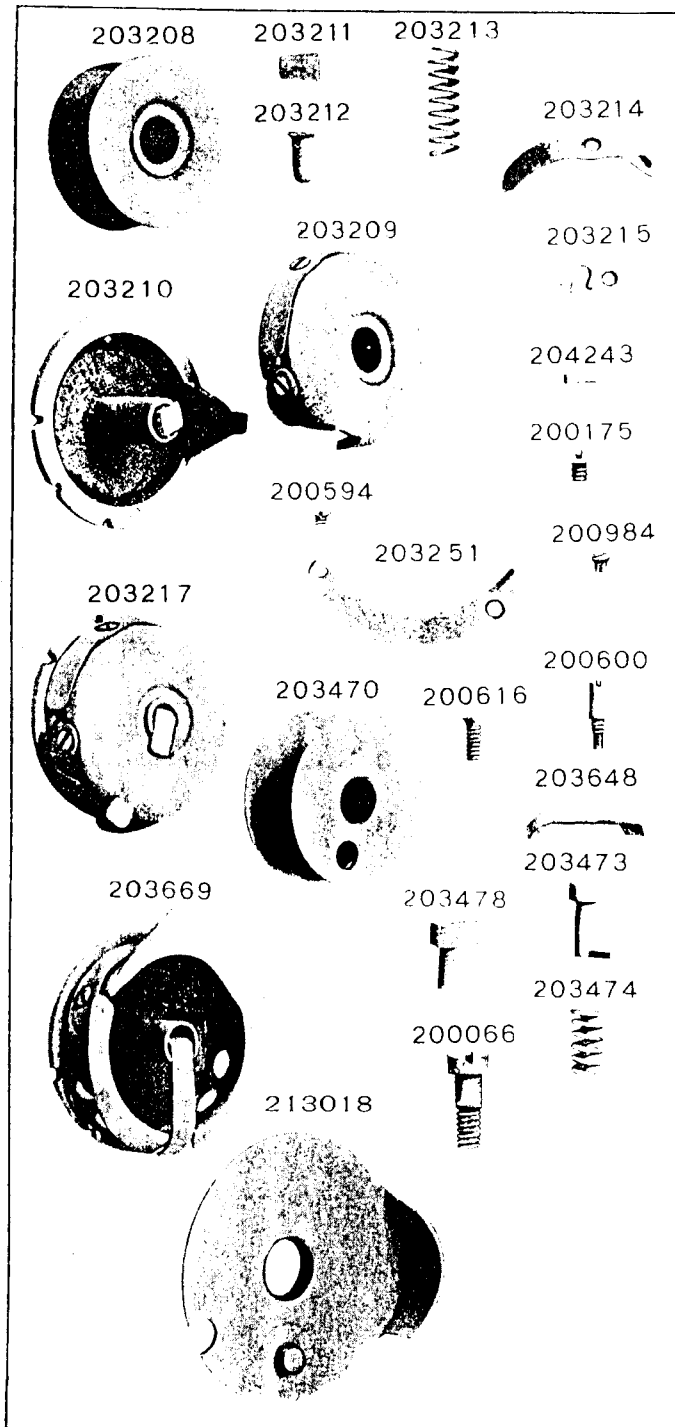


PLATE 11285 - FULL SIZE

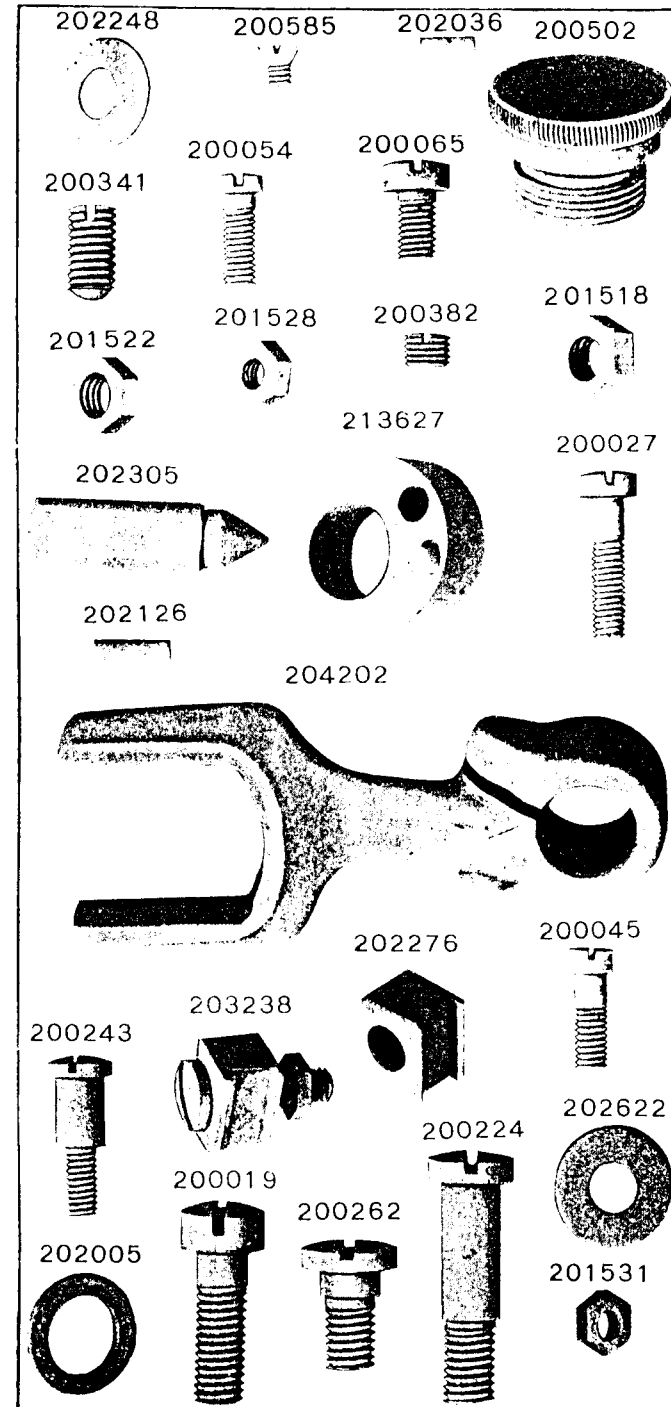


PLATE 11286 - FULL SIZE

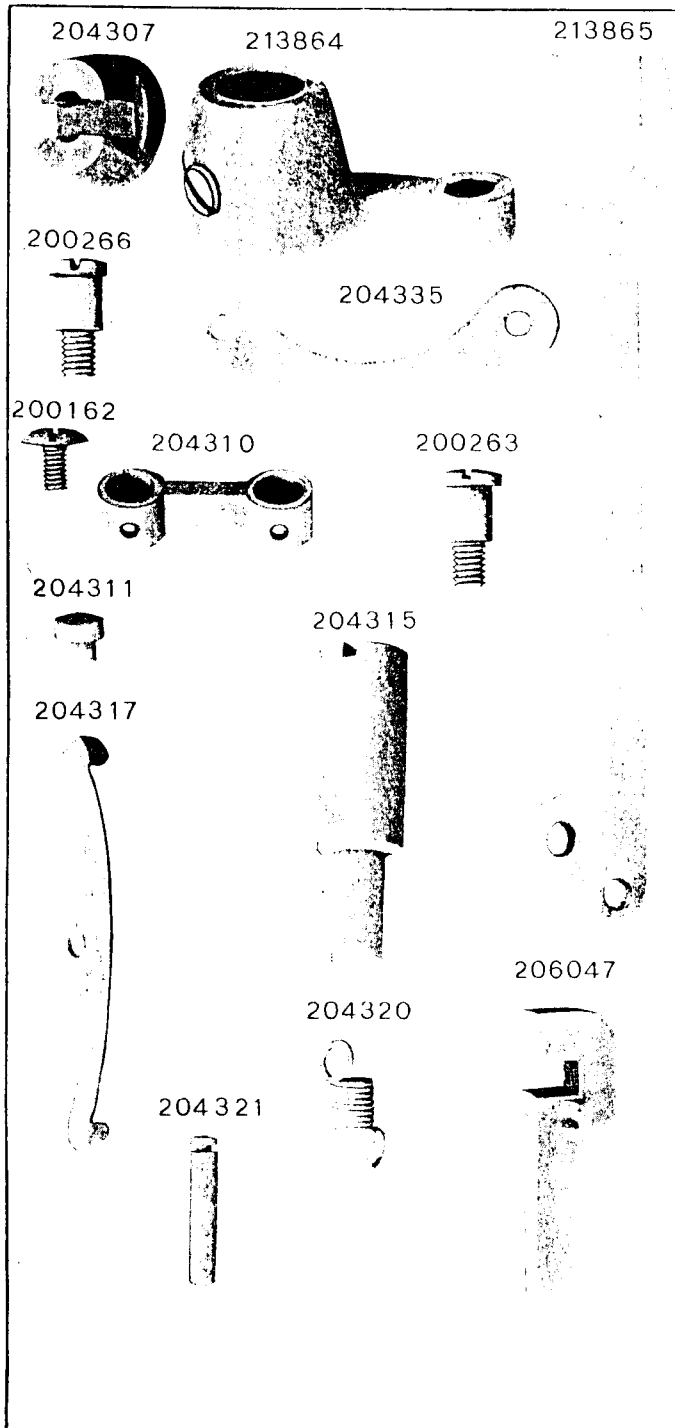


PLATE 11287 - FULL SIZE

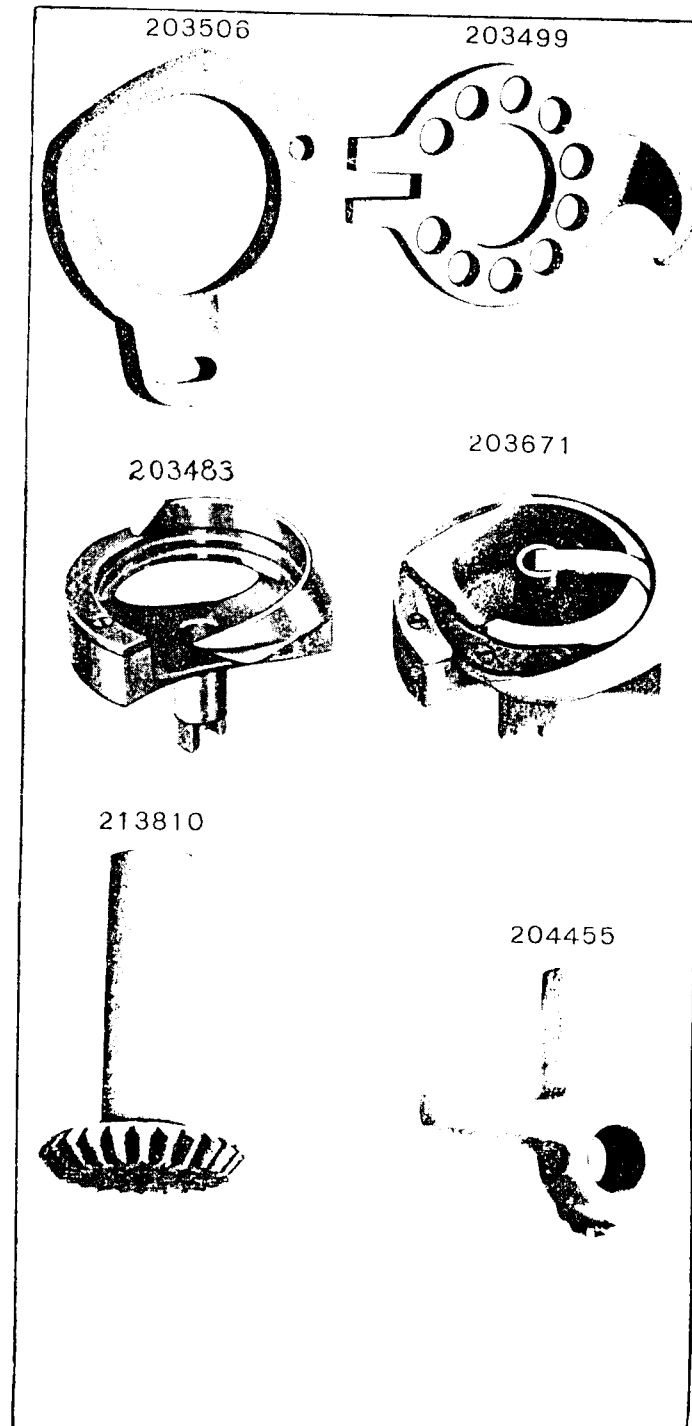




PLATE 11288 - ONE-HALF SIZE

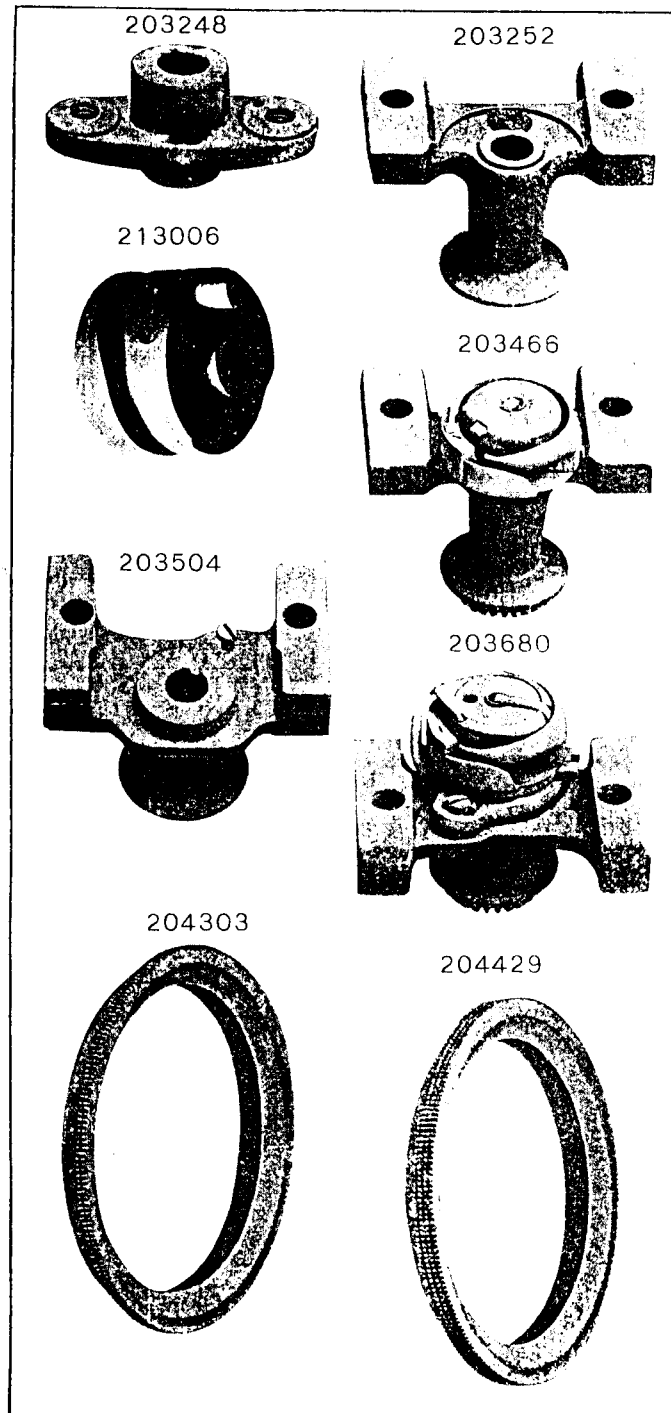


PLATE 11289 - ONE-HALF SIZE

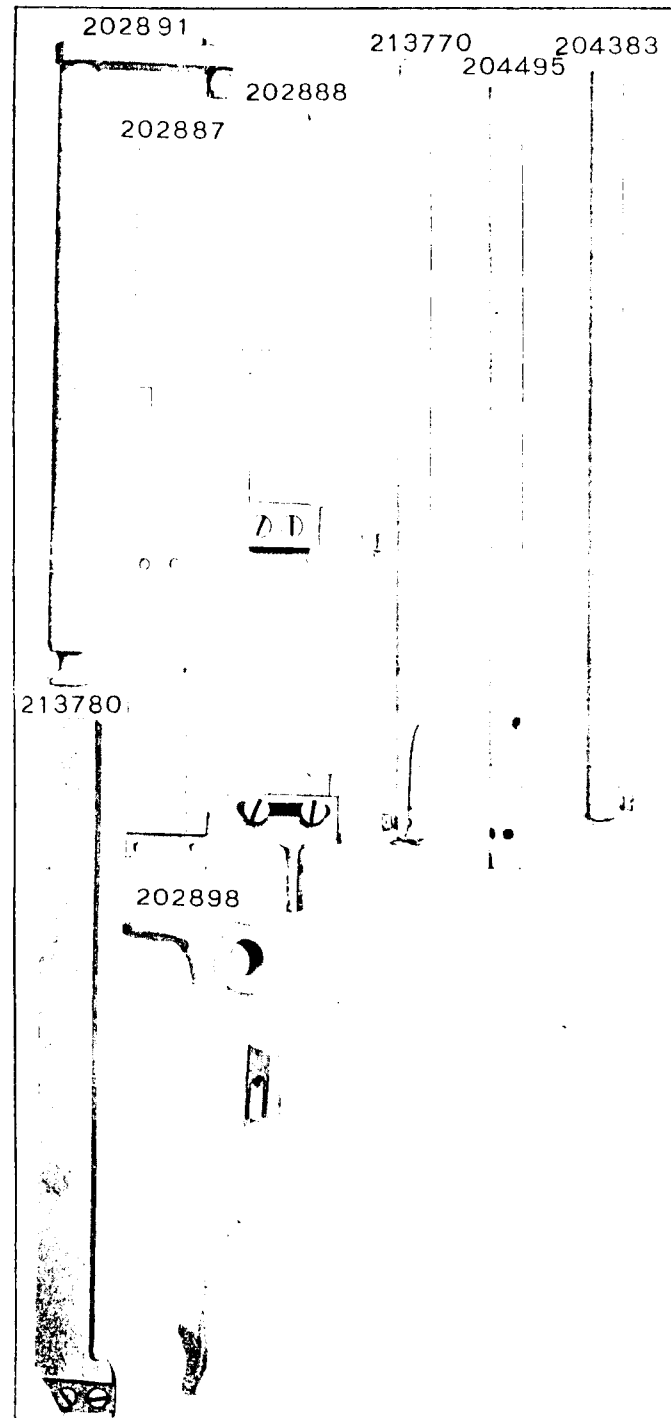


PLATE 11290 - FULL SIZE

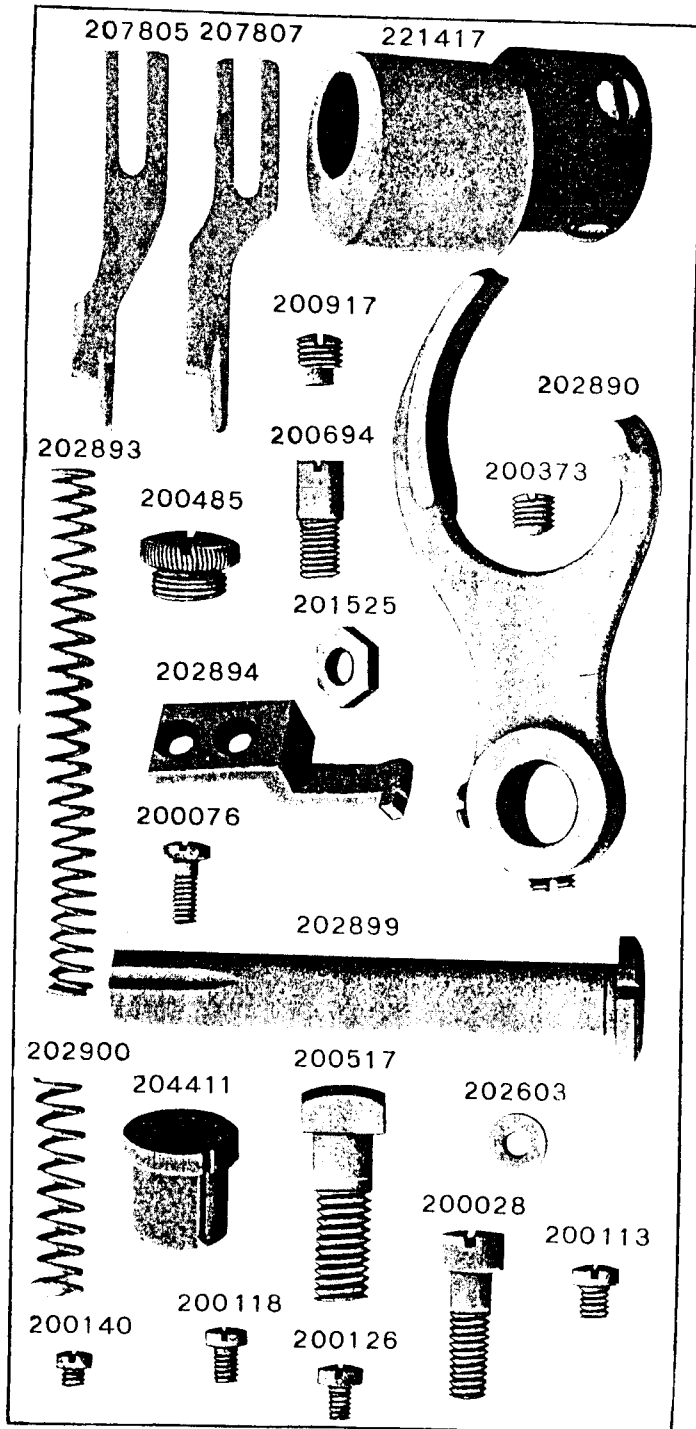


PLATE 11291 - FULL SIZE

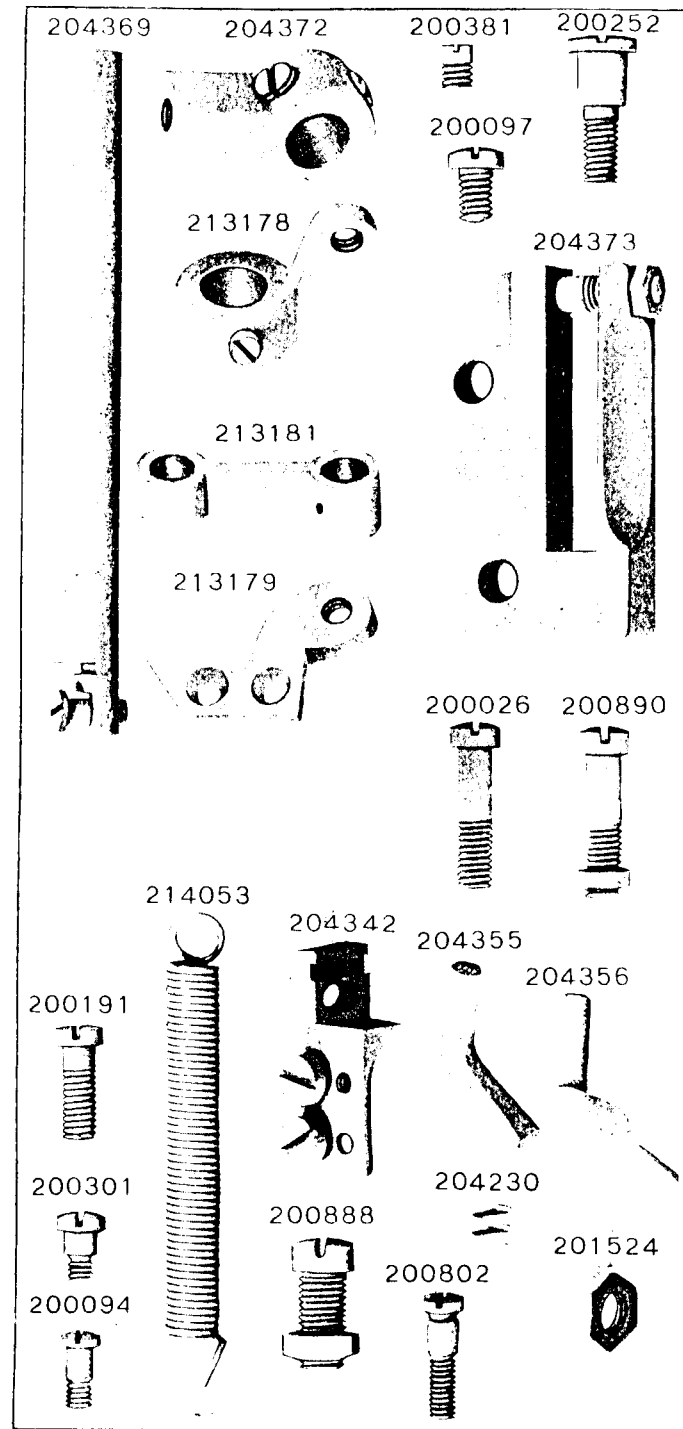


PLATE 11292-FULL SIZE

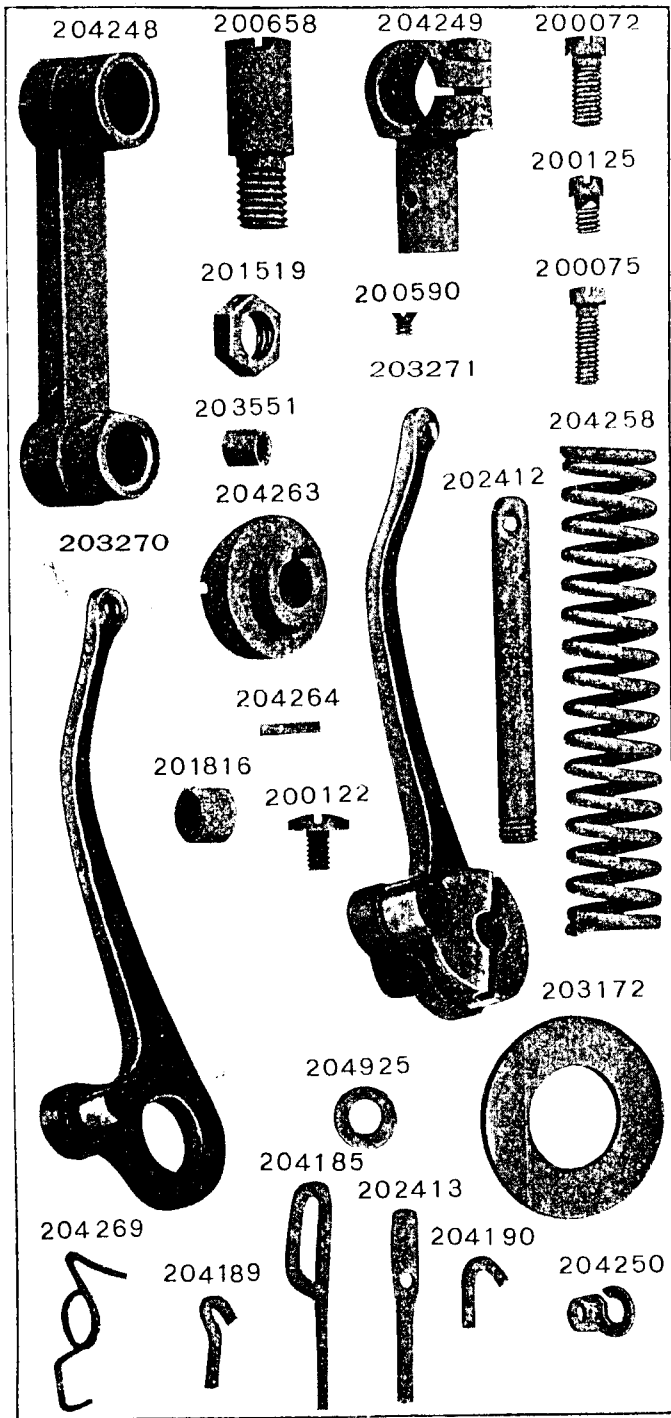


PLATE 11293-FULL SIZE

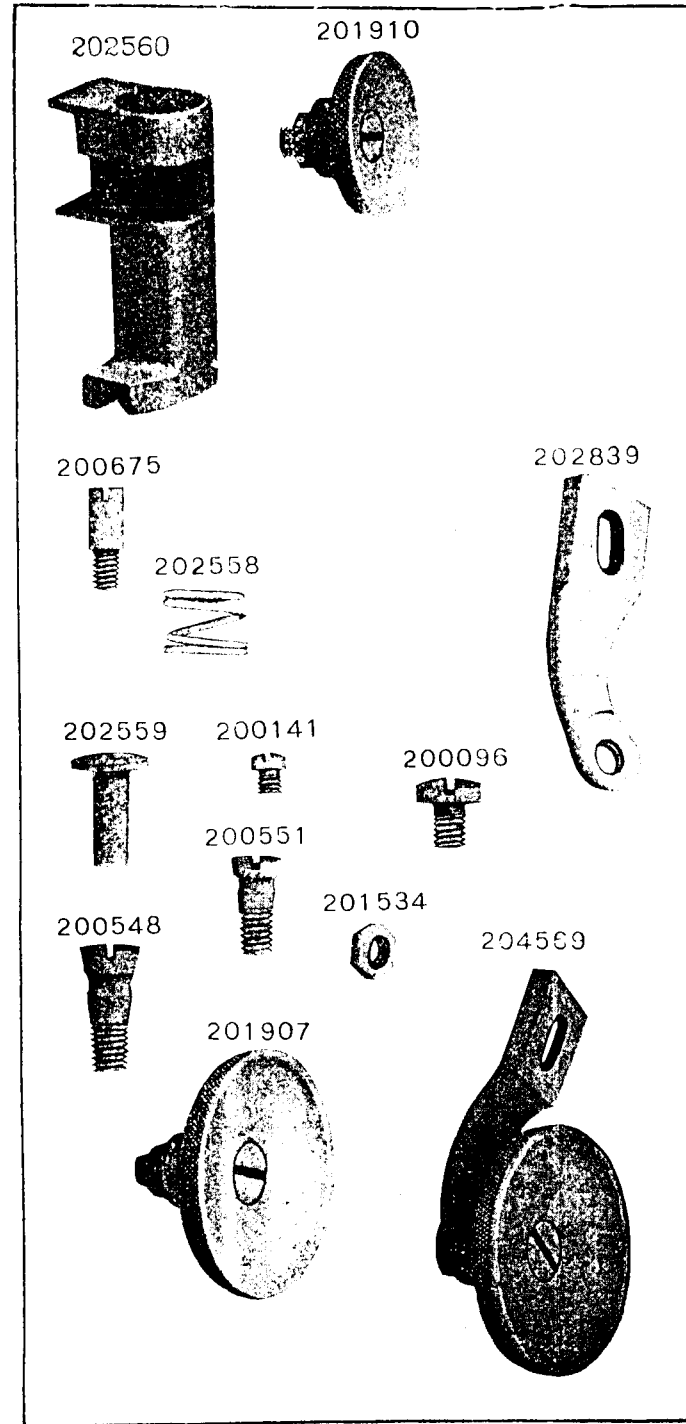
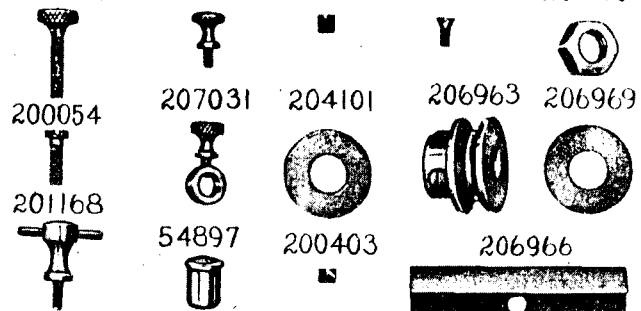
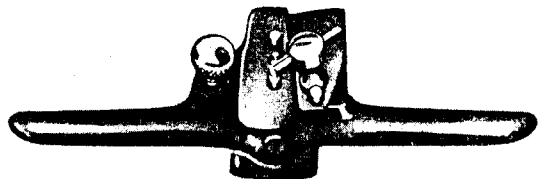


PLATE 11296—ONE-HALF SIZE

200457 200473 200394 200577 201510



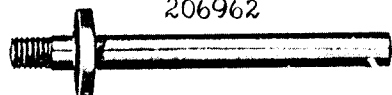
207029



206967



206962



244040

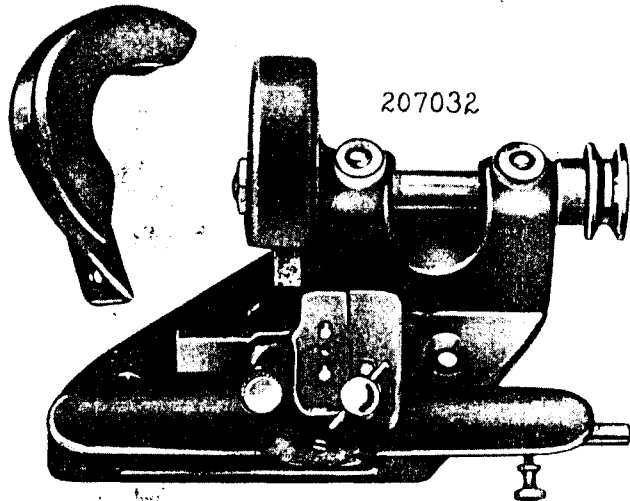
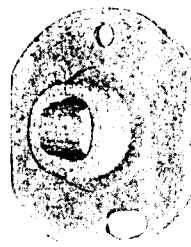


PLATE 11298—ONE-HALF SIZE

223429



223430

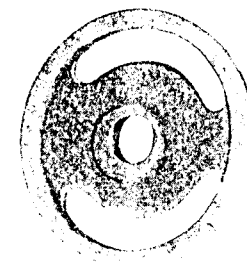


PLATE 11299 - FULL SIZE

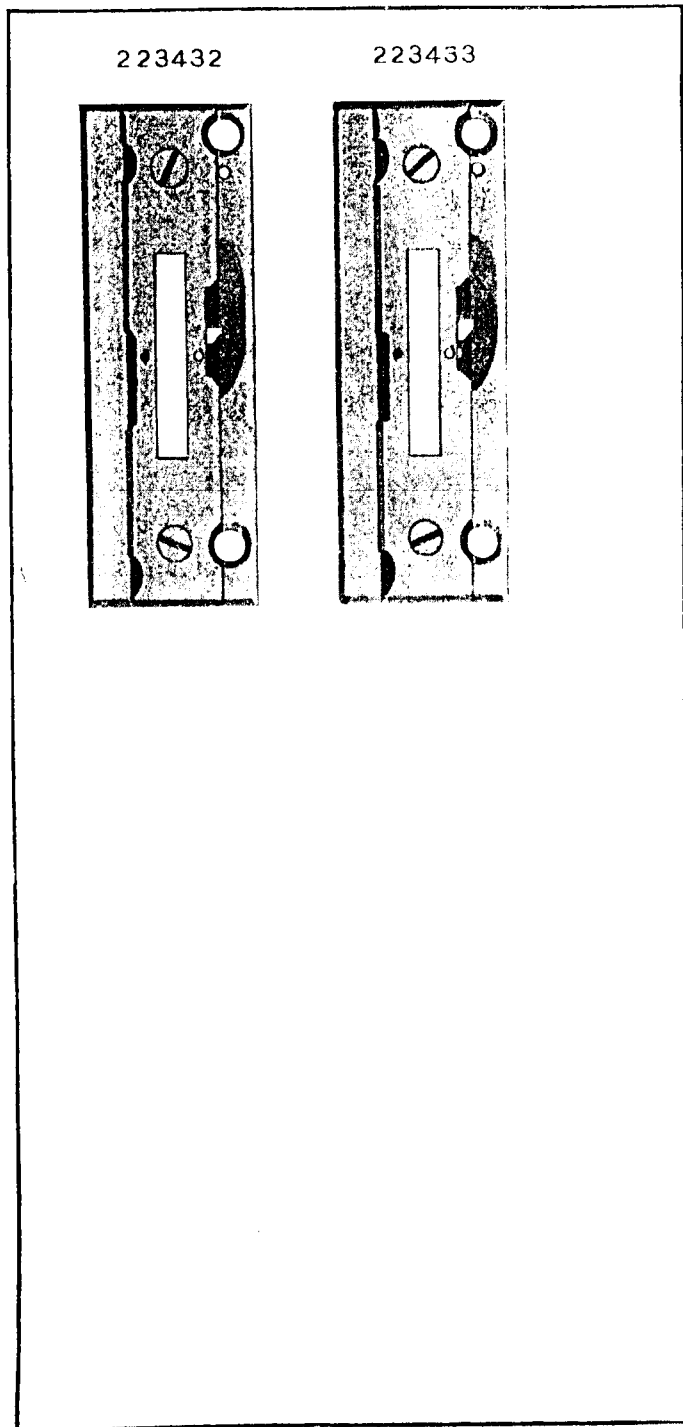


PLATE 12024 - FULL SIZE

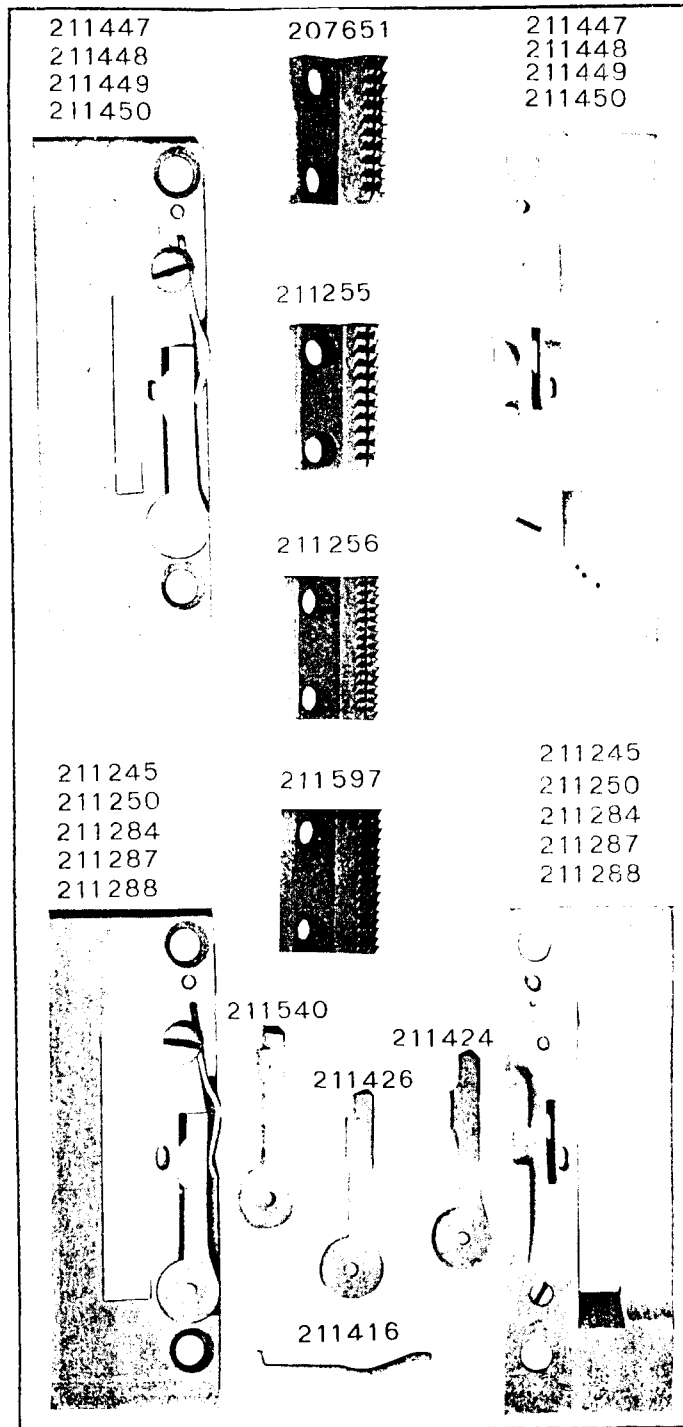
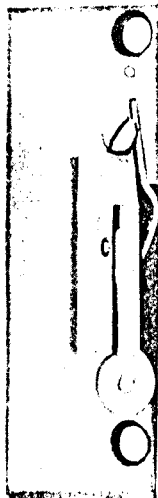
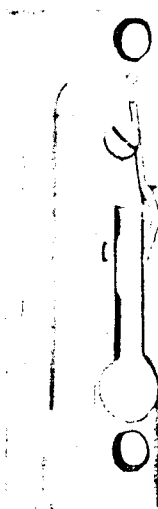


PLATE 12058—FULL SIZE

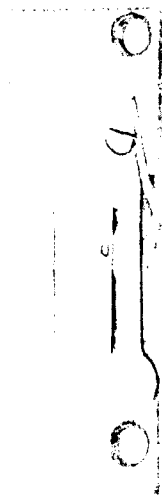
211292  
211451  
211452  
211453  
211454



211459  
211460  
211461  
211462



211455  
211456  
211457  
211458



211425



211463  
211464

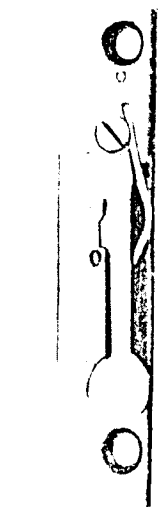
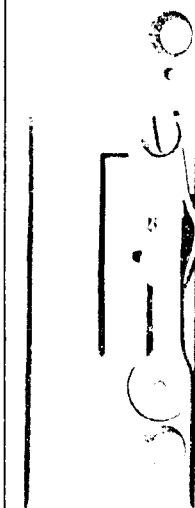
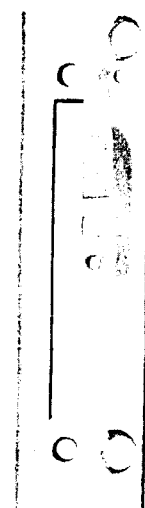


PLATE 12059—FULL SIZE

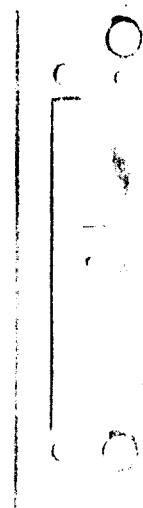
211465  
211466



211467



211468



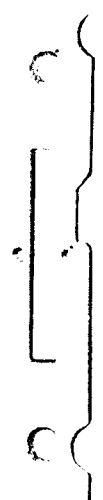
207464



207299



207471



207300

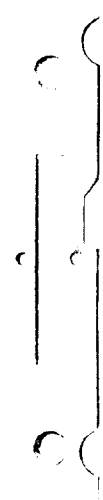
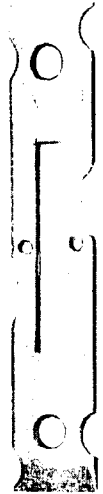


PLATE 12060—FULL SIZE

207472



207473



207470  
207487



207463



207474



207475



PLATE 12061—FULL SIZE

211493

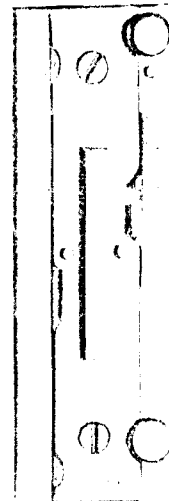
211494

211495

211496

211497

211498



211499

211500

211501

211502

211503

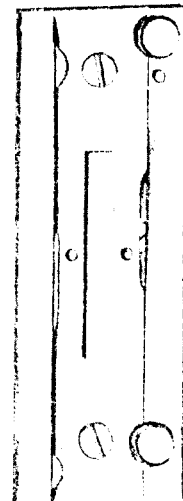
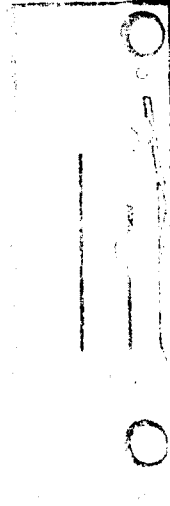
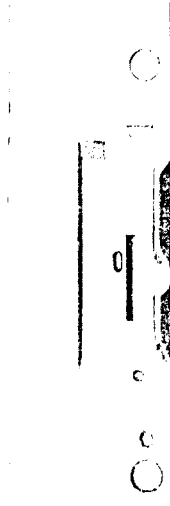
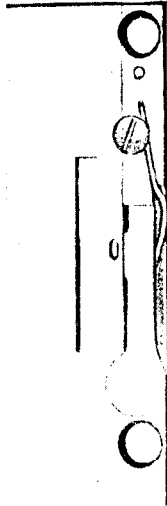


PLATE 12064—FULL SIZE

211421  
211481  
211482

211421  
211481  
211482

211420  
211422  
211483  
211484  
211605



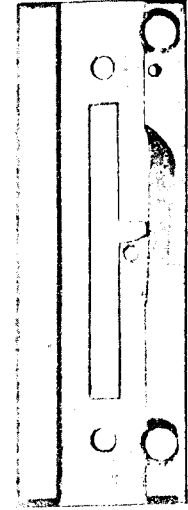
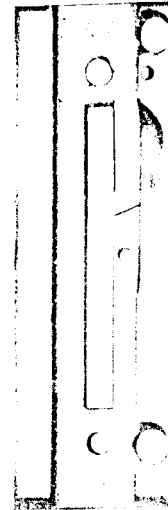
211285  
211286  
211485  
211486  
211973



PLATE 12065—FULL SIZE

211487

211488



211515  
211516  
211517  
211518  
211519  
211520

211521  
211522  
211523  
211524  
211525

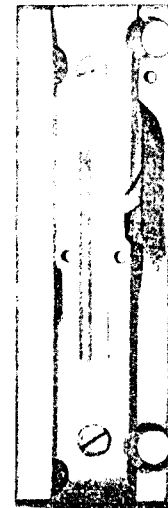




PLATE 12066—FULL SIZE

211489

211491

211490

211492

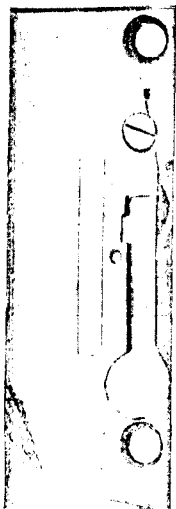


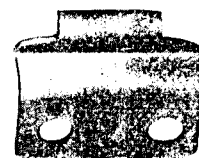
PLATE 12153—ONE HALF SIZE

41400

225498

225497

202258



120342

225554

120343

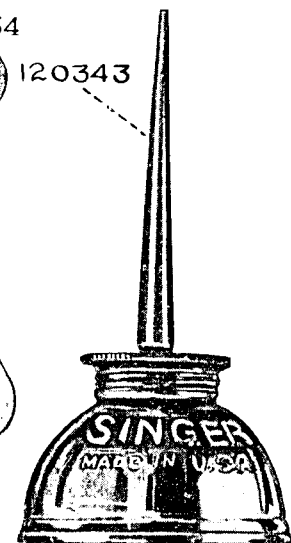
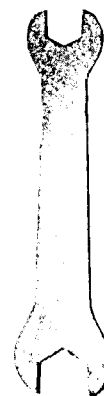


PLATE 12311—FULL SIZE

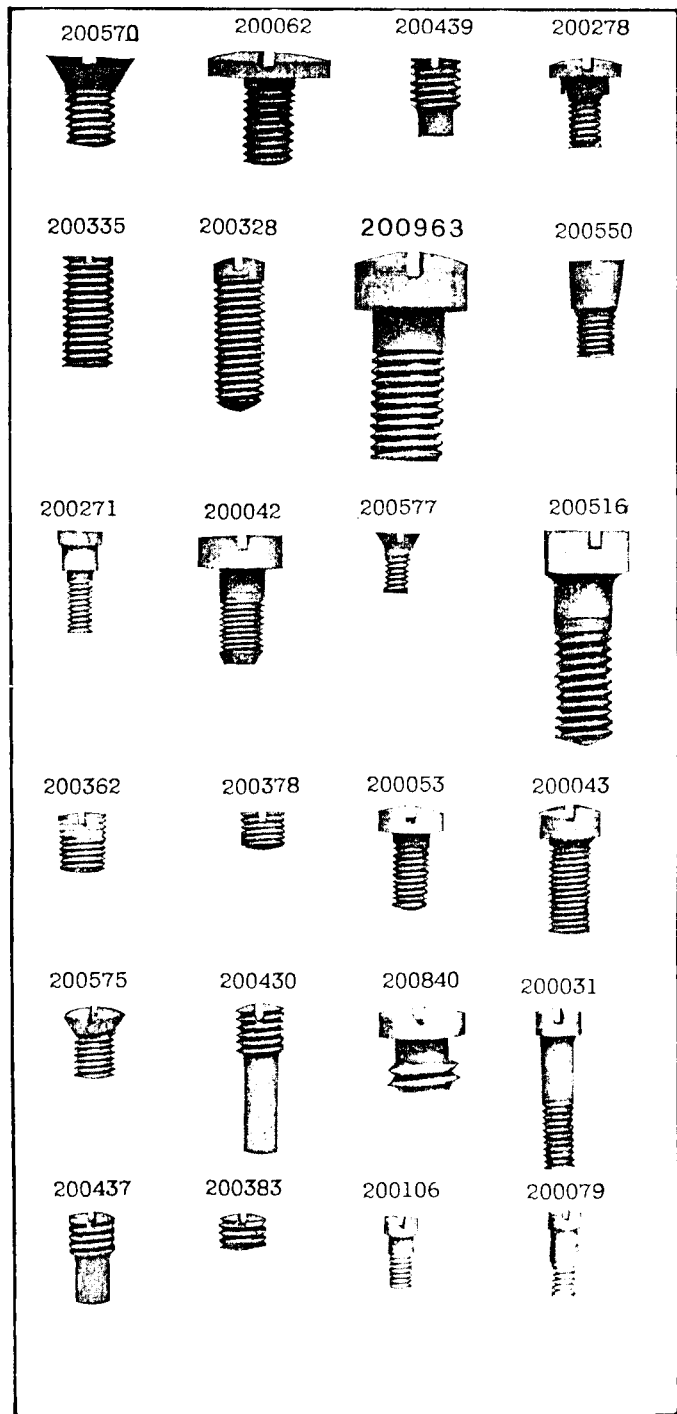


PLATE 12319—FULL SIZE

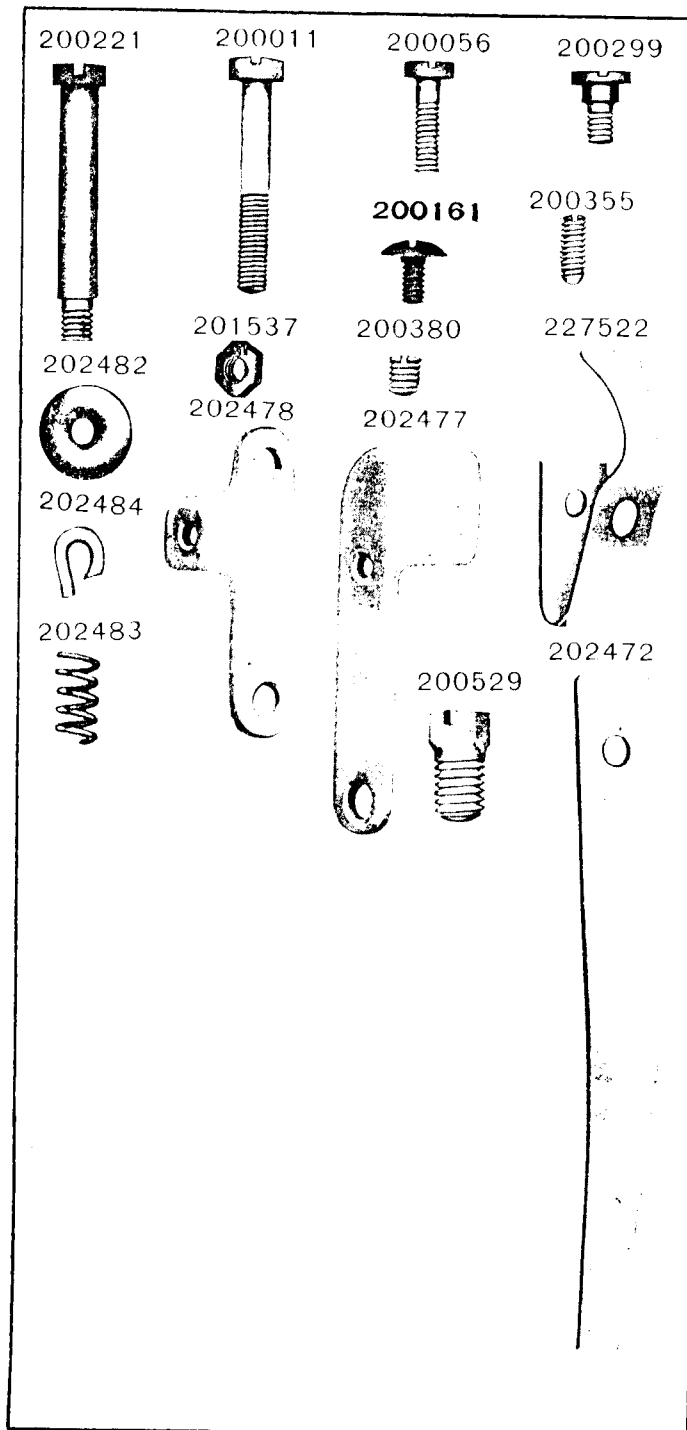


PLATE 12320—ONE-HALF SIZE

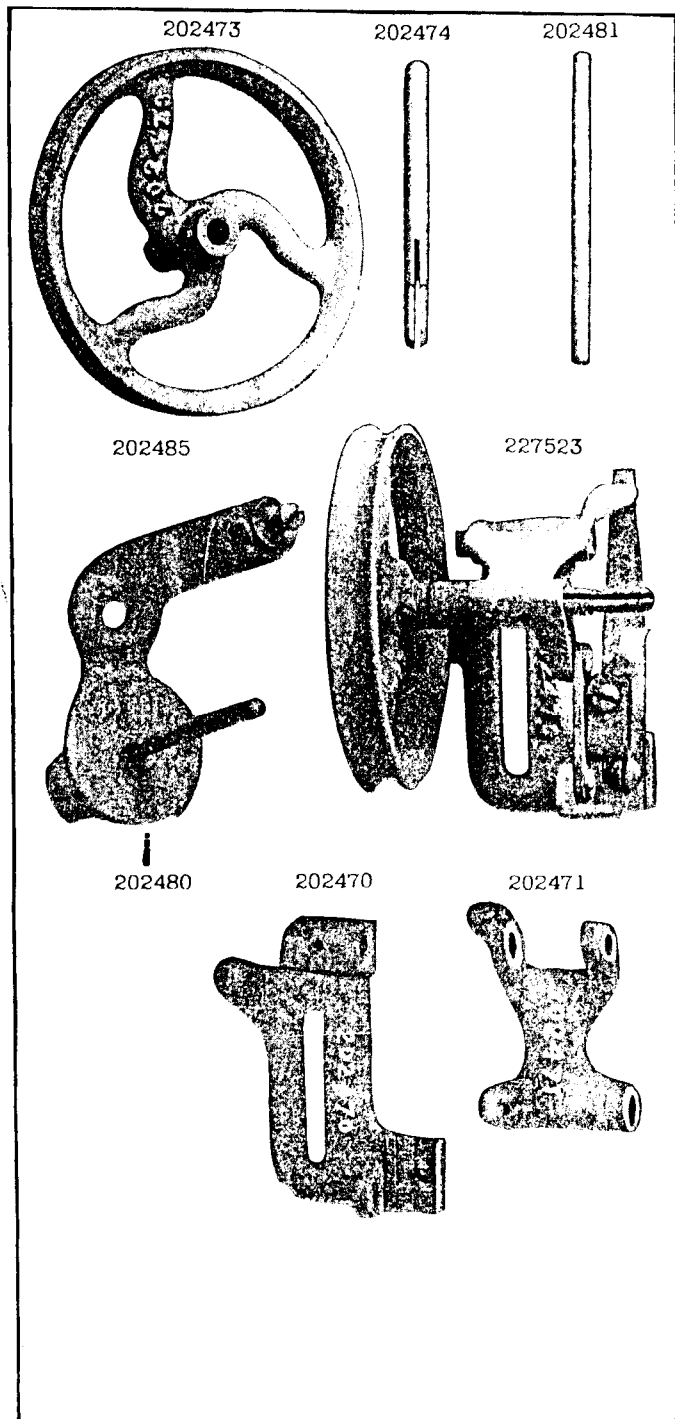


PLATE 12349—FULL SIZE

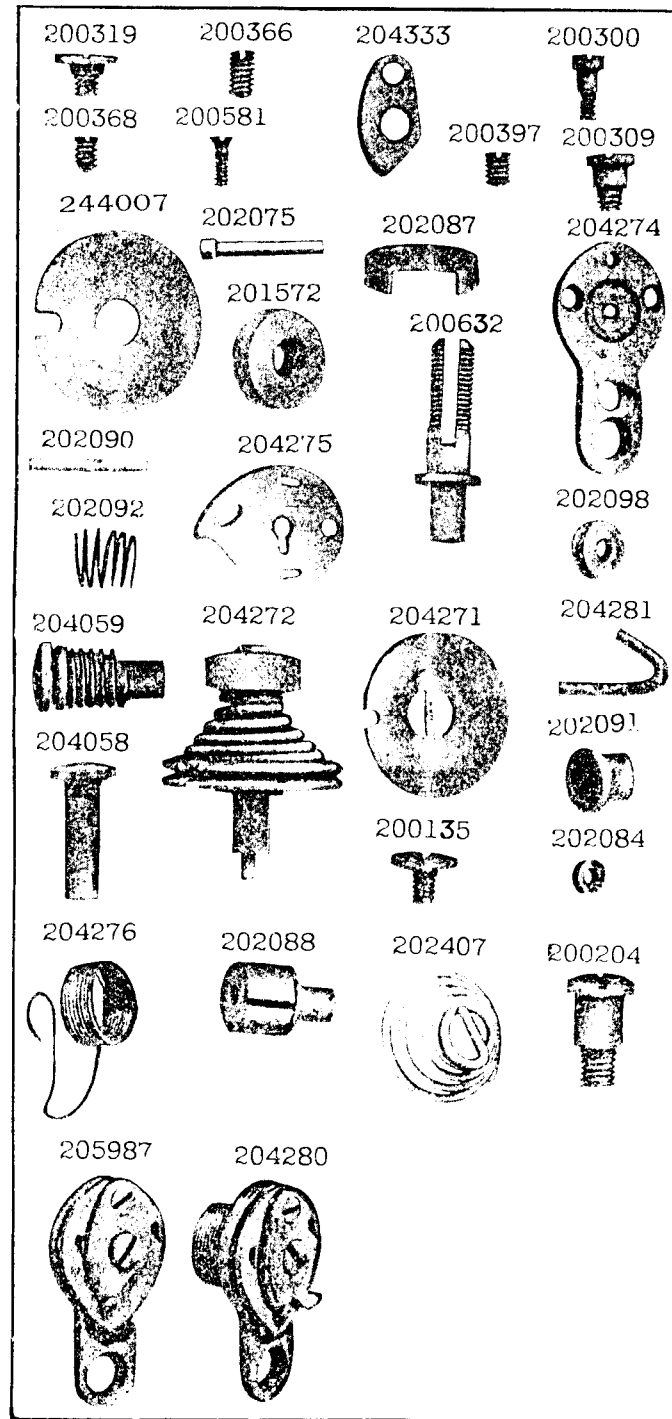


PLATE 14101—FULL SIZE

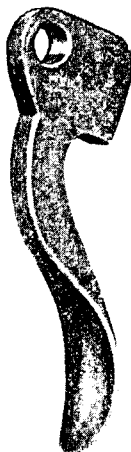
54897



202446



202554



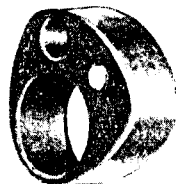
202737



204457



213007



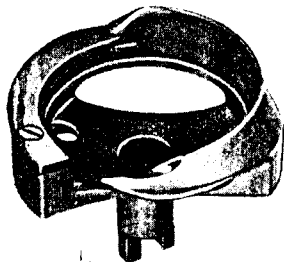
213112



223438



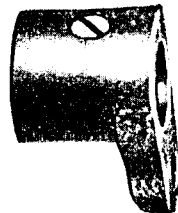
223435



204424



204308

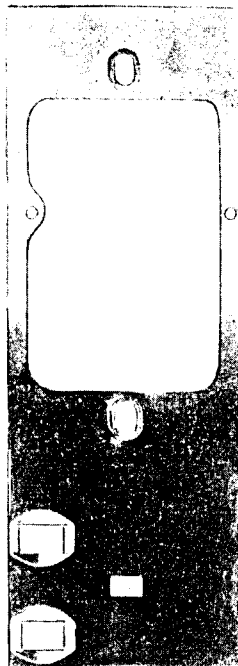


204387

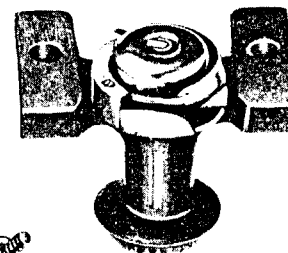


PLATE 14102—ONE-HALF SIZE

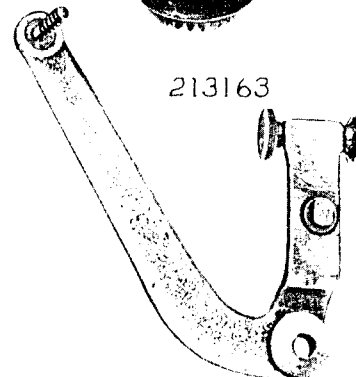
213162



223437



213163



228182



228181



223421

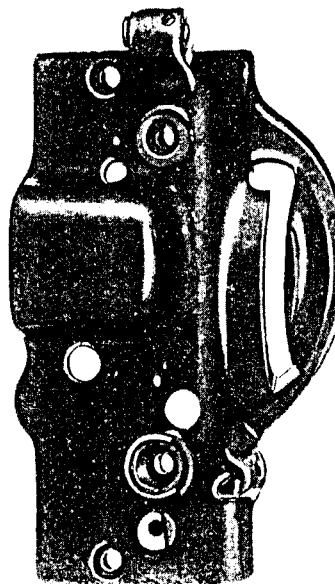


PLATE 14103—FULL SIZE

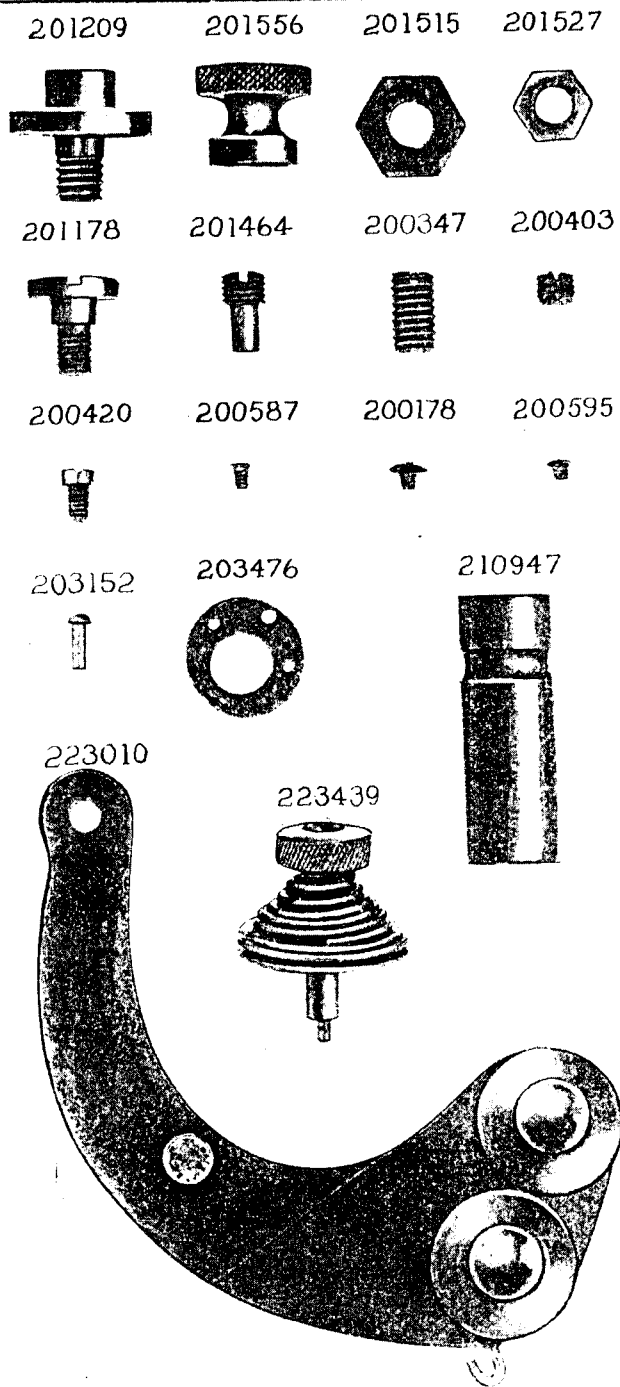


PLATE 14104—FULL SIZE

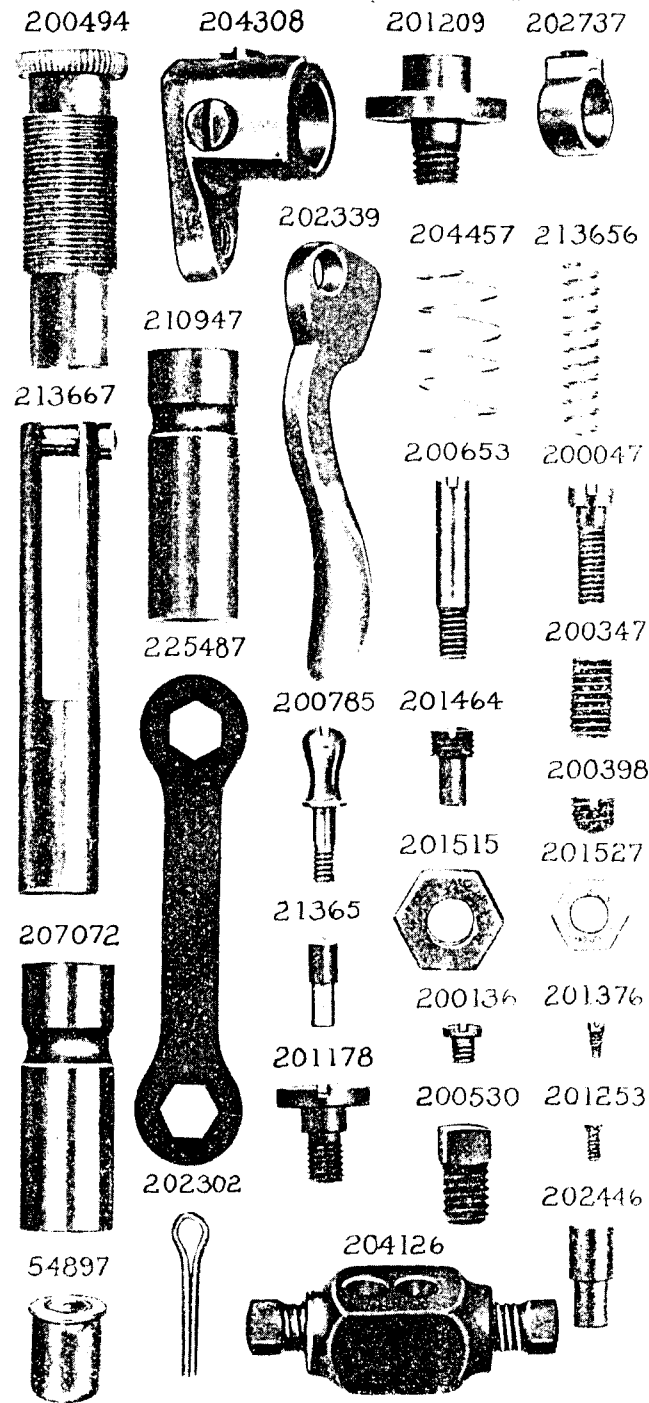
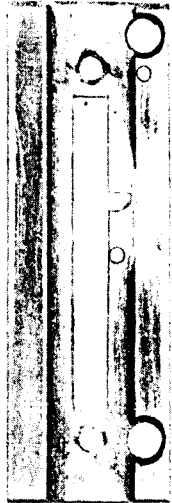


PLATE 14106—FULL SIZE

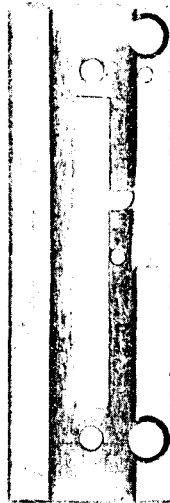
223443



223444



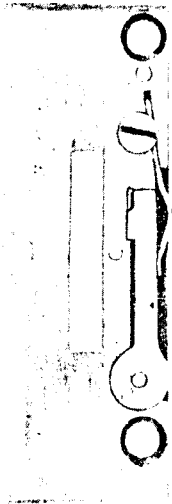
223445



223446



211463  
211464



211540



211425

207651



211597

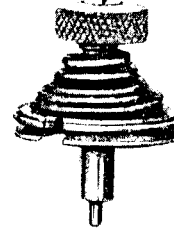


211416

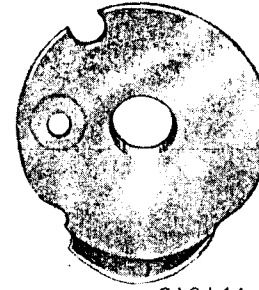


PLATE 14107—FULL SIZE

223439



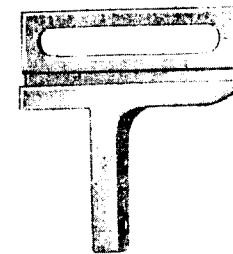
213018



202897



202895



208496



223423



213141



200898



200378



200380



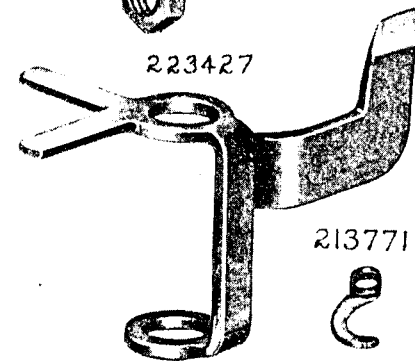
201519



200583



223427



213771



PLATE 14108—ONE-HALF SIZE

213879



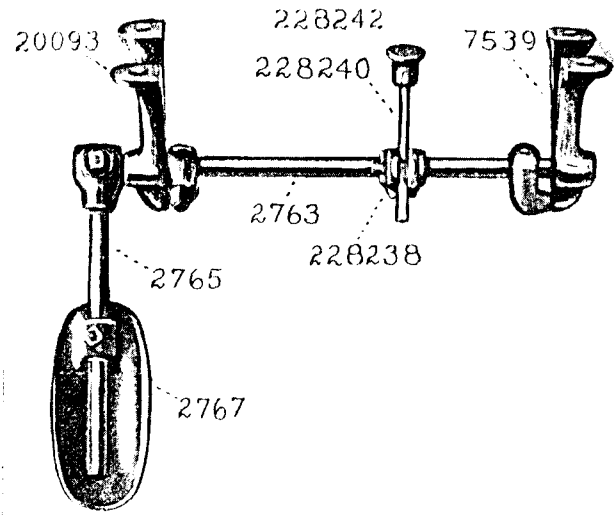
228184



227449



PLATE 14171—ONE-FOURTH SIZE



FULL SIZE

2766



2770



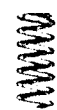
200529



228241



204225



8073



356



PLATE 14512—ONE-HALF SIZE

204306



204336

