

Form 8410—Revised
June, 1931
PRINTED IN U. S. A.

PARTS DEPARTMENT
HISTORICAL COPY
PARTS CATALOG
DO NOT REMOVE

LIST
OF
PARTS



MACHINE No. 25-56

THE SINGER MANUFACTURING COMPANY

COPYRIGHT, U. S. A., 1916, 1917, 1924 and 1931
BY THE SINGER MANUFACTURING Co.
ALL RIGHTS RESERVED FOR ALL COUNTRIES

INDEX

	PAGE
ACCESSORIES	15
BINDER	15
FOOT LIFTER PARTS	15
MACHINE BASE	14
MACHINE No. 25-56	7
NUMERICAL LIST OF PARTS	19
OBSOLETE PARTS	16
THREAD UNWINDER	16

INSTRUCTIONS FOR ORDERING

In ordering from this list, use **ONLY** the part **NUMBER** in the **FIRST** column.

The number stamped on a Sewing Machine part is in every case the number of the single part only.

Every combination of parts sent out as such has its specific number, which, although not stamped on the parts, must be used when ordering the combination.

Each number always indicates the **SAME PART** in whatever list it appears, or for whatever machine.

The letters after some of the numbers indicate the style of finish only, as follows:

- A—Hardened, Polished, Nickel Plated and Buffed
- B—Polished, Nickel Plated and Buffed
- C—Hardened Only
- D—Polished Only
- E—Soft, Not Polished
- F—Hardened and Polished
- H—Blued
- J—Nickel Plated Only
- K—Hardened and Nickel Plated
- L—Brass Plated
- M—Oxidized
- N—Japanned, Dull
- P—Japanned, Bright
- R—Merlized
- T—Copper Plated
- T. A.—Hardened, Polished, Copper and Nickel Plated and Buffed
- T. B.—Copper and Nickel Plated and Polished
- T. J.—Copper and Nickel Plated Only
- T. K.—Hardened, Copper and Nickel Plated
- T. M.—Copper Plated and Oxidized
- T. L.—Copper and Brass Plated
- U—Zinc Plated
- V—Silver Plated
- W—Polished and Nickel Plated
- Y—Black Nickel Plated Only
- Z—Chromium Plated
- Z. B.—Polished, Nickel Plated, Buffed and Chromium Plated
- Z. J.—Nickel and Chromium Plated

These letters **MUST BE USED** when they appear in the list; and **AFTER** the number **as** in the list.

In this series:
1 to 1500 and 50001 to 51500 are Screw Numbers
1501 to 1800 and 51501 to 51800 are Nut Numbers
1801 to 2000 and 51801 to 52000 are Roller Numbers
2001 to 50000 and 52001 and upward are numbers of Sewing Machine Parts and Electrical Parts

The figures in the second column refer only to the plates, illustrating the parts, and are **NOT TO BE USED** in ordering.

Parts marked with an asterisk (*) are furnished only when repairs are made at factory.

LIST OF PARTS COMPLETE FOR

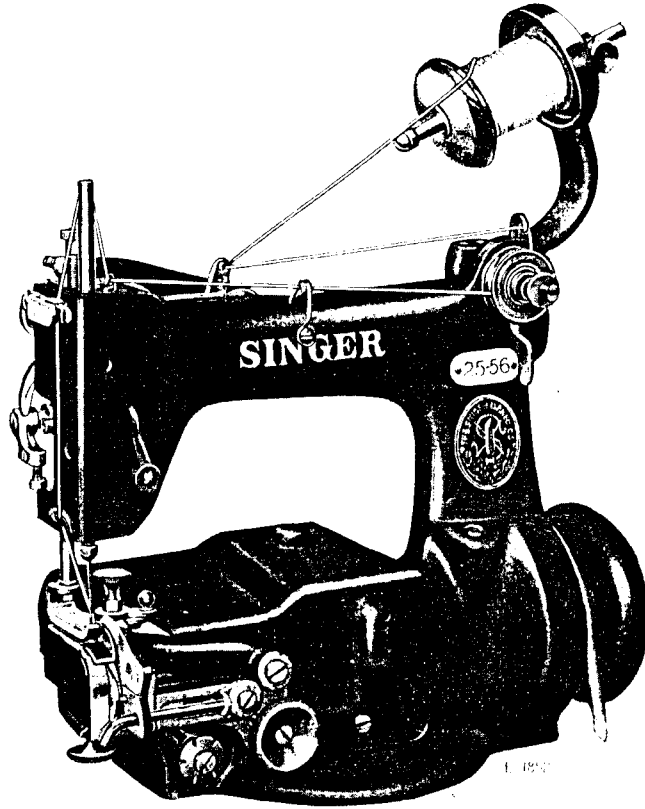

MACHINE No. 25-56

FOR STITCHING STRAW BRAID FOR HATS. BED NOT CYLINDRICAL. HAS LEVER ON SIDE OF ARM NEXT TO THE OPERATOR FOR THROWING THE TIPPER INTO AND OUT OF ACTION; COMPOUND TENSION, FOOT LIFTER. FURNISHED WITH FEED DOGS, GUIDES AND PRESSER FEET FOR DIFFERENT VARIETIES OF BRAID. ALL THE WORKING PARTS OF THIS MACHINE ARE MADE OF HARDENED STEEL AND ARE ENCLOSED. THE MACHINE IS BUSHED THROUGHOUT.

NO.	PLATE	NAME
*32234	—	Arm, upper and lower (solid) with 32233 and two 1485E.....

PARTS FOR MACHINE No. 25-56

NO.	PLATE	NAME
32275	—	Arm End Cover.....
32276	7073	" " " 32275 with 32277.....
32277	—	" " " Belt Guard.....
219F	7063	" " " Screw.....
*32233	—	" Extension.....
1485E	7063	" " Screw.....
32144	7051	" Rock Shaft.....
32145	7052	" " " Bushing (back).....
624c	7052	" " " " " Set Screw
32146	7052	" " " " (front).....
624c	7052	" " " " " Set Screw
32147	7052	" " " Crank (back) with 1259c
		and 50275c.....
50275c	7052	Arm Rock Shaft Crank (back) Position
		Screw.....
1259c	7052	Arm Rock Shaft Crank (back) Set Screw..
32148	7052	" " " " (front) with 1266c
		and 50275c.....
50275c	7052	Arm Rock Shaft Crank (front) Position
		Screw.....
1266c	7052	Arm Rock Shaft Crank (front) Set Screw
32149	7051	" Rotary Shaft with 1019c.....
32150	7052	" " " Bushing (back).....
889c	7052	" " " " " Set Screw
32151	7052	" " " " (front).....
462c	7052	" " " " " Set Screw
32152	7052	" " " Collar with two 889c..
889c	7052	" " " " Set Screw.....
32231	7051	Balance Wheel and Connecting Rod Eccen- tric, 1¾ in. pulley, with 1285c.....
32267	—	Balance Wheel and Connecting Rod Eccen- tric 32231 with 32253.....
32225	7051	Balance Wheel and Connecting Rod Eccen- tric Oil Pad (felt).....
32226	7052	Balance Wheel and Connecting Rod Eccen- tric Oil Pad Oil Hole Packing (braided cotton).....
1285c	7063	Balance Wheel and Connecting Rod Eccen- tric Set Screw.....
32227	7051	Connecting Rod with 32096 and two 896E
32253	—	" " 32227 with 1520j and 50276c.....
*32096	—	Connecting Rod Cap.....
896E	7063	" " " Screw.....
50276c	7063	" " Hinge Screw.....
1520j	7063	" " " " Nut.....

PARTS FOR MACHINE No. 25-56

NO.	PLATE	NAME
32155	7052	Face Plate.....
330W	7052	" " Screw.....
32156	7052	" " Thread Guard.....
32157	7051	Feed Bar with 440c.....
32264	—	" " 32157 with 32098, 32158 and 32169.....
32158	7053	Feed Bar Carrier with four 624c.....
32159	7053	" " " Hinge Pin.....
32160	7053	" " " " " Bushing (left)
446c	7053	" " " " " " " "
		Set Screw.....
32161	7053	Feed Bar Carrier Hinge Pin Bushing (right)
446c	7053	" " " " " " " "
		Set Screw.....
624c	7052	Feed Bar Carrier Hinge Pin Set Screw...
32162	7067	" " Cover.....
190W	7063	" " " Screw.....
32098	7051	" " Hinge Pin.....
624c	7052	" " " " Set Screw.....
32163	7053	" Connecting Rod with 1012E, 32164 and two 896E.....
1012E	7053	Feed Connecting Rod Adjusting Screw...
*32164	—	" " " Cap.....
896E	7063	" " " " Screw.....
32071	2195	" Dog, for Japanese.....
19015	2195	" " " medium or Milan.....
19018	2195	" " " fine or chip.....
19094	2195	" " " chip.....
32220	2195	" " " fine Milan tape.....
32165	7053	" " Carrier.....
32254	—	" " " 32165 with 995c.....
19020	7053	" " " Friction Spring.....
22441	7064	" " " " " Washer
995c	7053	" " " Regulating Thumb Screw
996c	7053	" " " Screw.....
997c	7053	" " Screw.....
32166	7054	" Eccentric with two 889c.....
889c	7052	" " Set Screw.....
32167	7054	" Lifting Eccentric with two 889c...
32168	7054	" " " Connection.....
32169	7054	" " " " Bar...
440c	7063	" " " " " Set Screw.....
889c	7052	Feed Lifting Eccentric Set Screw.....
50277c	7054	" Regulating Screw Stud.....
1627c	7054	" " " " Nut.....
42290	7064	" " " " Washer.....

PARTS FOR MACHINE No. 25-56

NO.	PLATE	NAME
32170	7054	Lifting Presser Bar.....
9830	7054	" " " " " " Set
624c	7052	Screw.....
9830	7054	Lifting Presser Bar Bushing (upper).....
462c	7052	" " " " " " Set
		Screw.....
32122	7054	Lifting Presser Bar Guide and Lifting Bracket with 390j.....
390j	7054	Lifting Presser Bar Guide and Lifting Bracket Adjusting Screw.....
1155H	7054	Lifting Presser Bar Guide and Lifting Bracket Screw.....
32171	7054	Lifting Presser Bar Lifter.....
32235	7054	" " " " " " Set
460c	7054	Screw.....
32124	7054	Lifting Presser Bar Lifting Arm with 223E and 1083c.....
1083c	7054	Lifting Presser Bar Lifting Arm Adjust- ing Screw.....
223E	7054	Lifting Presser Bar Lifting Arm Adjust- ing Screw Clamping Screw.....
32125	7054	Lifting Presser Bar Lifting Arm Disen- gaging Lever.....
2273	7054	Lifting Presser Bar Lifting Arm Disen- gaging Lever Pin.....
32172	7055	Lifting Presser Bar Lifting Arm Disen- gaging Lever Shaft.....
32127	7055	Lifting Presser Bar Lifting Arm Disen- gaging Lever Shaft Crank with 175w..
175w	7055	Lifting Presser Bar Lifting Arm Disen- gaging Lever Shaft Crank Clamping Screw.....
14026	7055	Lifting Presser Bar Lifting Arm Pin.....
32173	7055	" " " " " " Position Spring.....
190w	7063	Lifting Presser Bar Lifting Arm Position Spring Screw.....
32129	7055	Lifting Presser Bar Lifting Arm Shaft
32130	7055	" " " " " " " "
		Bushing.....
624c	7052	Lifting Presser Bar Lifting Arm Shaft Bushing Set Screw.....
32174	7055	Lifting Presser Bar Lifting Arm Shaft Driving Lever with 1999.....

NO.	PLATE	NAME
14026	7055	Lifting Presser Bar Lifting Arm Shaft Driving Lever Pin.....
1999	7055	Lifting Presser Bar Lifting Arm Shaft Driving Lever Roller and Stud.....
50278j	7063	Lifting Presser Bar Pressure Regulating Thumb Screw.....
51807	7055	Lifting Presser Bar Roller and Screw Stud
19034	7055	" " " " Spring (light).....
32038	—	" " " " (heavy).....
19035	7055	" " " " Bracket.....
32175	7055	" " " " Stud.....
19036	7057	" " " " Foot (narrow toe).....
32176	7056	" " " " (narrow) for binding.....
32177	7056	" " " " (wide) for binding...
32178	7056	" " " " with Guide, for braid, for high rolled edge.....
32179	7056	Lifting Presser Foot with Guide and 32214 (wide, Japanese).....
32180	7056	Lifting Presser Foot with Guide (coarse Canton).....
32181	7056	Lifting Presser Foot with Guide, for extra heavy braid.....
32182	7056	Lifting Presser Foot with Guide and 32268, for coarse braid.....
701j	7064	Lifting Presser Foot Adjusting Screw
32210	7057	" " " " " " " Washer.....
32211	7057	Lifting Presser Foot Plate.....
32212	7057	" " " " Shank.....
32213	—	Lifting Presser Foot (adjustable) com- plete, Nos. 704j and 32210 to 32212...
32072	2195	Lifting Presser Foot Guide (Canton) with 19083.....
32073	2195	Lifting Presser Foot Guide (coarse Canton) with 19082.....
19040	2195	Lifting Presser Foot Guide (fine Canton)
19041	2195	" " " " (Milan).....
32136	7057	" " " " (chip) for short stitch.....
32183	7057	Lifting Presser Foot Guide (tape) for fine work.....
32137	7057	Lifting Presser Foot Guide (tape) for short stitch.....
19043	2195	Lifting Presser Foot Guide Adjusting Lever with 19045 and 19046.....
19020	7053	Lifting Presser Foot Guide Adjusting Lever Friction Washer.....

NO.	PLATE	NAME
19045	2195	Lifting Presser Foot Guide Adjusting Lever Handle.....
19046	2195	Lifting Presser Foot Guide Adjusting Lever Pin.....
1003c	2195	Lifting Presser Foot Guide Adjusting Lever Thumb Screw.....
19083	2195	Lifting Presser Foot Guide Stud for 32072
19082	2195	" " " " " " 32073
32214	7056	" " " " " " 32179
32268	—	" " " " " " 32182
50161c	7055	" " " Screw.....
19047	7055	" " " Washer.....
19048	7055	Looper with 34418.....
32217	7055	" Gate.....
32218	—	" " 32217 with 32219 and two 337j.....
36006	7055	Looper Gate Friction Washer.....
946D	7055	" " Hinge Screw.....
32185	7055	" " Lock Stud.....
14058	7055	" " " " Spring.....
453c	7055	" " " " " Stop Screw.....
32219	7055	" " Thread Guard.....
337j	7055	" " " " Screw.....
1019c	7055	" Set Screw.....
34418	7055	" Washer.....
32186	7058	Needle Bar (hollow) with 12495 and 32273
32255	7064	" " Bushing (lower).....
624c	7052	" " " " Set Screw....
9830	7054	" " " (upper).....
624c	7052	" " " " Set Screw...
34170	7058	" " Connecting Link with two 1313E.....
1313E	7058	Needle Bar Connecting Link Adjusting Screw.....
32111	7058	Needle Bar Connecting Stud with 195E and 1296c.....
195E	7058	Needle Bar Connecting Stud Clamping Screw.....
32273	7064	Needle Bar (thread eyelet) Extension...
12495	7064	" " " " " Pin
1296c	7058	" " Position Screw.....
1737c	7058	" Clamping Nut.....
32236	7059	Plait Guide (lower).....
32237	7059	" " (upper).....
32262	7064	" " " Friction Washer.....
89c	7059	" " " Hinge Screw.....
32238	7059	" " " Holder with 54705..

NO.	PLATE	NAME
32239	7059	Plait Guide (upper) Lock Stud.....
32240	7059	" " " " " Spring
50117E	7059	" " " " " " Screw.....
208E	7063	Plait Guide (upper) Screw.....
646J	7064	" " " " Stud.....
54705	7059	" " " Steady Pin.....
32241	—	Plait Guide complete, Nos. 89c, 208E, 32236 to 32240, 32262 and 50117E.....
32190	7060	Plait Guide Block.....
402E	7060	" " " Screw.....
19020	7053	" " Friction Washer.....
19055	7060	" " Regulating Pinion.....
1004F	7060	" " " " Screw.....
1005F	7060	" " Screw.....
19056	7060	" " (inside edge) Nos. 19059 and 19060.....
19059	—	Plait Guide (inside edge) Plate.....
19060	—	" " " " Rod.....
32242	7059	" " (stationary) Nos. 32243 and 32244.....
32243	7059	Plait Guide (stationary) Bracket with 735c
32244	7059	" " " " Rod.....
735c	7059	" " " " Set Screw....
32112	7065	Spool Bracket with 1009c.....
29627	7058	" " Dowel Pin.....
129D	7063	" " Screw.....
32083	2196	" Spindle.....
32084	—	Spool Spindle complete, Nos. 32083, 32086, 32087, 32089, 50159B and 50160c.....
1009c	2196	Spool Spindle Set Screw.....
32085	2196	" " Washer (felt).....
32086	2196	" " " (steel) with 32085..
32191	7058	Tension Disc.....
1712c	7058	" Regulating Thumb Nut.....
32192	7058	" Regulator.....
32193	7058	" " Bushing.....
32194	7058	" " Friction Spring.....
32195	7058	" " Plate.....
393c	7058	" " " Screw.....
50279c	7058	" Screw Stud.....
32266	—	" " " 50279c with 1712c...
51808	7058	" " " Roller.....
910c	7058	" " " Set Screw.....
13710	7058	" Spring.....
32572	7058	" " Washer.....

NO.	PLATE	NAME
32196	7058	Tension Thread Guard.....
223F	7054	" " " Set Screw.....
32197	7061	Thread Controller Bracket.....
190w	7063	" " " Screw.....
32198	7061	" " " Guide Plate.....
19071	7061	" " " Releasing Rod.....
32199	7061	" " " Spring (inside).....
32200	7061	" " " " (outside).....
32201	7061	" " " Eyelet (side of arm).....
330D	7061	" " " " " Screw.....
32279	7064	" " " " (top of arm).....
335w	—	" " " " " Screw.....
32087	2196	" " " Guiding Disc with two 32088.....
32088	2196	" " " Bushing.....
50159B	2196	" " " Cap Screw.....
50160c	2196	" " " Screw Stud.....
32089	2196	" " " Washer.....
32202	7061	" " " Pull-off Lever with 1933.....
19076	7064	" " " Cam with two 460c.....
460c	7054	" " " " " Set Screw....
701D	7061	" " " " Hinge Screw.....
1933	7061	" " " " Roller and Stud...
32256	7062	Throat Plate with 662J, 32258, 32259 and two 19078, for 19015, 19018, 19094 and 32071.....
32257	7062	Throat Plate with 662J, 32258, 32259 and two 19078, for 32220.....
32258	7062	Throat Plate Oil Hole Cover.....
32259	7062	" " " " " Spring.....
662J	7062	" " " " " " Screw.....
1011F	7062	" " " Screw.....
19078	7062	" " " Steady Pin.....

MACHINE BASE

NO.	PLATE	NAME
32245	7067	Machine Base with 25761, 32247, and three each 32246 and wood screws 1 in. No. 14.....
25761	7064	Machine Base Pin.....
32247	7064	" " Cushion (felt) oblong.....
32246	7064	" " " " round.....

ACCESSORIES

NO.	PLATE	NAME
50280J	7063	Machine Thumb Screw for power table...
1166J	7063	" " " " Stand.....
2015	7061	" " " Cushion (rubber).....
9842	7061	" " " Washer.....
120344	7066	Oiler (copper plated) with 120345.....
120345	7066	" Spout, 5 in. long.....
26026	7066	Screw Driver (large).....
26485	7066	" " (small).....
19079	7066	Wrench for 1083, 1628 and 1737.....
32207	7066	" " 50277.....

BINDER

FOR BINDING STRAW BRAID

NO.	PLATE	NAME
28834	2172	Folder.....
219F	7063	" Screw.....
7071	7061	" " Washer.....
19036	2172	Lifting Presser Foot (narrow toe).....
28835	2172	Binder complete, Nos. 219F, 7071, 19036 and 28834.....

FOOT LIFTER PARTS

NO.	PLATE	NAME
6439	—	Chain, 36 in. to 45 in., with 56864 and 56865.....
NOTE: When ordering No. 6439 state length required.		
56864	7064	Chain Hook (large).....
56865	7064	" " (small).....
4879	7066	" Connecting Link.....
32208	7066	Lifting Lever.....
21D	7063	" " Hinge Screw.....
19081	7061	" " Spring.....
59051	7067	Treadle.....
7585	7066	" Shaft.....
14357	7067	" Stand.....
59074	7067	Treadle complete, Nos. 4879, 7585, 14357, 59051 and two wood screws 1 1/4 in. No. 12
32209	—	Foot Lifter complete, Nos. 21D, 6439, 19081, 32208 and 59074.....

THREAD UNWINDER

FOR ONE SPOOL

NO.	PLATE	NAME
225389	8523	Spool Rest with 201018c.....
225388	8523	" " Rod.....
200383c	7064	" " " Set Screw.....
201018c	7064	" " " Set Screw.....
202490	8523	" Stand with 200383c.....
225391	8523	Thread Guide.....
201696J	7064	" " Lock Nut.....
225392	8523	" " Rod with 208E and 225393
208E	7063	" " " Screw.....
225393	7064	" " " Washer.....
225394	8523	Thread Unwinder complete, Nos. 201696J, 202490, 225388, 225389, 225391, 225392 and three wood screws $\frac{7}{8}$ in. No. 12...
27739	7073	Thread Cone (wood) for large cones.....
225390	—	" " Holder, for inverted cones..

NOTE: Nos. 27739 and 225390 are used with, but not included in 225394.

OBSOLETE PARTS

NO.	PLATE	NAME
32228	—	Arm End Cover for 32229.....
32229	7051	" " " 32228 with 32230, use 32276.....
32230	—	Arm End Cover Belt Guard for 32229....
19021	7053	Feed Dog Carrier Friction Spring Washer, use 22441.....
19025	7054	Feed Regulating Screw Stud Washer, use 42290.....
9954	7054	Lifting Presser Bar Lifting Arm Pin.....
1094F	7057	" " Foot Adjusting Screw, use 704J.....
19044	2195	Lifting Presser Foot Guide Adjusting Lever Friction Washer, use 19020.....
32110	7058	Needle Bar Bushing (lower).....
19020	7053	Plait Guide (upper) Friction Washer, use 32262.....
32156	7052	Thread Eyelet (top of arm) use 32279....
32203	7061	" Pull-off Lever Cam with two 465c, use 19076.....
465c	7061	Thread Pull-off Lever Cam Set Screw for 32203.....

NO.	PLATE	NAME
32204	7062	Throat Plate with 664J, 32205 and two 19078, for 19015, 19018, 19094 and 32071, use 32256.....
32221	7062	Throat Plate with 664J, 32205 and two 19078, for 32220, use 32257.....
32205	7062	Throat Plate Oil Hole Cover.....
664J	7062	" " " " " Screw.....

Genuine Singer Needles and their Containers are marked with the Company's Trade Mark "SIMANCO." 1

Needles in Containers marked "For Singer Machines" are not Singer made needles. 2

NUMERICAL LIST OF PARTS

NO. PLATE	NAME
21d 7063	Lifting Lever Hinge Screw for 32209.....
89c 7059	Plait Guide (upper) Hinge Screw for 32211
129d 7063	Spool Bracket Screw.....
175w 7055	Lifting Presser Bar Lifting Arm Disen- gaging Lever Shaft Crank Clamping Screw for 32127.....
190w 7063	Feed Bar Cover Screw.....
190w 7063	Lifting Presser Bar Lifting Arm Position Spring Screw.....
190w 7063	Thread Controller Bracket Screw.....
195E 7058	Needle Bar Connecting Stud Clamping Screw for 32111.....
208E 7063	Plait Guide (upper) Screw for 32241.....
208E 7063	Thread Unwinder Thread Guide Rod Screw for 225392.....
219F 7063	Arm End Cover Screw.....
219F 7063	Binder Folder Screw for 28835.....
223E 7054	Lifting Presser Bar Lifting Arm Adjust- ing Screw Clamping Screw for 32124...
223F 7054	Tension Thread Guard Set Screw.....
330w 7052	Face Plate Screw.....
330w 7061	Thread Eyelet (side of arm) Screw.....
335w ----	“ “ (top of arm) Screw.....
337j 7055	Looper Gate Thread Guard Screw for 32218.....
390j 7054	Lifting Presser Bar Guide and Lifting Bracket Adjusting Screw for 32122.....
393c 7058	Tension Regulator Plate Screw.....
402E 7060	Plait Guide Block Screw.....
440c 7063	Feed Lifting Eccentric Connection Bar Set Screw for 32157.....
446c 7053	Feed Bar Carrier Hinge Pin Bushing (left) Set Screw.....
446c 7053	Feed Bar Carrier Hinge Pin Bushing (right) Set Screw.....
453c 7055	Looper Gate Lock Stud Spring Stop Screw
460c 7054	Lifting Presser Bar Lifter Hinge Stud Set Screw.....
460c 7054	Thread Pull-off Lever Cam Set Screw for 19076.....
462c 7052	Arm Rotary Shaft Bushing (front) Set Screw.....
462c 7052	Lifting Presser Bar Bushing (upper) Set Screw.....

NUMERICAL LIST OF PARTS

NO. PLATE	NAME
465c 7061	Thread Pull-off Lever Cam Set Screw for 32203, obsolete.....
624c 7052	Arm Rock Shaft Bushing (back) Set Screw.....
624c 7052	Arm Rock Shaft Bushing (front) Set Screw.....
624c 7052	Feed Bar Carrier Hinge Pin Set Screw for 32158.....
624c 7052	Feed Bar Hinge Pin Set Screw for 32158..
624c 7052	Lifting Presser Bar Bushing (lower) Set Screw.....
624c 7052	Lifting Presser Bar Lifting Arm Shaft Bushing Set Screw.....
624c 7052	Needle Bar Bushing (lower) Set Screw...
624c 7052	" " " (upper) Set Screw...
646j 7064	Plait Guide (upper) Screw Stud.....
662j 7062	Throat Plate Oil Hole Cover Spring Screw for 32256 and 32257.....
664j 7062	Throat Plate Oil Hole Cover Screw for 32204 and 32221, obsolete.....
701b 7061	Thread Pull-off Lever Hinge Screw.....
704j 7064	Lifting Presser Foot Adjusting Screw for 32213.....
735c 7059	Plait Guide (stationary) Rod Set Screw for 32243.....
889c 7052	Arm Rotary Shaft Bushing (back) Set Screw.....
889c 7052	Arm Rotary Shaft Collar Set Screw for 32152.....
889c 7052	Feed Eccentric Set Screw for 32166.....
889c 7052	" Lifting Eccentric Set Screw for 32167.....
896E 7063	Connecting Rod Cap Screw for 32227....
896E 7063	Feed Connecting Rod Cap Screw for 32163
910c 7058	Tension Screw Stud Set Screw.....
946d 7055	Looper Gate Hinge Screw.....
995c 7053	Feed Dog Carrier Regulating Thumb Screw for 32254.....
996c 7053	Feed Dog Carrier Screw.....
997c 7053	" " Screw.....
1003c 2195	Lifting Presser Foot Guide Adjusting Lever Thumb Screw.....
1004F 7060	Plait Guide Regulating Pinion Screw....
1005F 7060	" " Screw.....
1009c 2196	Spool Spindle Set Screw for 32112.....
1011F 7062	Throat Plate Screw.....

NUMERICAL LIST OF PARTS

NO. PLATE	NAME
1012E 7053	Feed Connecting Rod Adjusting Screw for 32163.....
1019c 7055	Looper Set Screw for 32149.....
1083c 7054	Lifting Presser Bar Lifting Arm Adjusting Screw for 32124.....
1094F 7057	Lifting Presser Foot Adjusting Screw, obsolete, use 701J.....
1155H 7054	Lifting Presser Bar Guide and Lifting Bracket Screw.....
1166j 7063	Machine Thumb Screw, for stand (Accessories).....
1259c 7052	Arm Rock Shaft Crank (back) Set Screw for 32147.....
1266c 7052	Arm Rock Shaft Crank (front) Set Screw for 32148.....
1285c 7063	Balance Wheel and Connecting Rod Eccentric Set Screw for 32231.....
1296c 7058	Needle Bar Position Screw for 32111.....
1313E 7058	" " Connecting Link Adjusting Screw for 34170.....
1485E 7063	Arm Extension Screw for 32234.....
1520j 7063	Connecting Rod Hinge Screw Nut for 32253.....
1627c 7054	Feed Regulating Screw Stud Nut.....
1712c 7058	Tension Regulating Thumb Nut for 32266
1737c 7058	Needle Clamping Nut.....
1933 7061	Thread Pull-off Lever Roller and Stud for 32202.....
1999 7055	Lifting Presser Bar Lifting Arm Shaft Driving Lever Roller and Stud for 32174.....
2015 7061	Machine Thumb Screw Cushion, rubber (Accessories).....
2273 7054	Lifting Presser Bar Lifting Arm Disengaging Lever Pin.....
4879 7066	Chain Connecting Link for 59074.....
6439 —	" 36 in. to 45 in., with 56864 and 56865, for 32209.....
7071 7061	Binder Folder Screw Washer for 28835..
7585 7066	Treadle Shaft for 59074.....
9830 7054	Lifting Presser Bar Bushing (lower).....
9830 7054	" " " " (upper).....
9830 7054	Needle Bar Bushing (upper).....
9842 7061	Machine Thumb Screw Washer (Accessories).....
9954 7054	Lifting Presser Bar Lifting Arm Pin, obsolete.....

NO.	PLATE	NAME
12495	7064	Needle Bar (thread eyelet) Extension Pin for 32186.....
13710	7058	Tension Spring.....
14026	7055	Lifting Presser Bar Lifting Arm Pin.....
14026	7055	" " " " " Shaft Driving Lever Pin.....
14058	7055	Looper Gate Lock Stud Spring.....
14357	7067	Treadle Stand for 59074.....
19015	2195	Feed Dog for medium or Milan.....
19018	2195	" " " fine or chip.....
19020	7053	" " Carrier Friction Spring.....
19020	7053	Lifting Presser Foot Guide Adjusting Lever Friction Washer.....
19020	7053	Plait Guide Friction Washer.....
19020	7053	" " (upper) Friction Washer, obsolete, use 32262.....
19021	7053	Feed Dog Carrier Friction Spring Washer, obsolete, use 22441.....
19025	7054	Feed Regulating Screw Stud Washer, obsolete, use 42290.....
19034	7055	Lifting Presser Bar Spring (light).....
19035	7055	" " " " Bracket.....
19036	7057	Binder Lifting Presser Foot (narrow toe) for 28835.....
19036	7057	Lifting Presser Foot (narrow toe).....
19040	2195	" " " Guide (fine Canton).....
19041	2195	" " " " (Milan).....
19043	2195	" " " " Adjusting Lever with 19045 and 19046.....
19044	2195	Lifting Presser Foot Guide Adjusting Lever Friction Washer, obsolete, use 19020.....
19045	2195	Lifting Presser Foot Guide Adjusting Lever Handle for 19043.....
19046	2195	Lifting Presser Foot Guide Adjusting Lever Pin for 19043.....
19047	7055	Lifting Presser Foot Washer.....
19048	7055	Looper with 34418.....
19055	7060	Plait Guide Regulating Pinion.....
19056	7060	" " (inside edge) Nos. 19059 and 19060.....
19059	---	Plait Guide (inside edge) Plate for 19056.....
19060	---	" " " " Rod for 19056.....
19071	7061	Thread Controller Releasing Rod.....
19076	7064	" Pull-off Lever Cam with two 460c.....
19078	7062	Throat Plate Steady Pin for 32204, 32221, 32256 and 32257.....

NO.	PLATE	NAME
19079	7066	Wrench for 1083, 1628 and 1737 (Accessories).....
19081	7061	Lifting Lever Spring for 32209.....
19082	2195	" " Presser Foot Guide Stud for 32073.....
19083	2195	" " " " " " " 32072.....
19094	2195	Feed Dog for chip.....
22411	7064	" " Carrier Friction Spring Washer.....
25761	7064	Machine Base Pin for 32245.....
26026	7066	Screw Driver (large) Accessories.....
26485	7066	" " (small) Accessories.....
27739	7073	Thread Cone (wood) for large cones, for 225394.....
28834	2172	Binder Folder for 28835.....
28835	2172	Binder complete, for binding straw braid, Nos. 219F, 7071, 19036, and 28834.....
29627	7058	Spool Bracket Dowel Pin.....
32038	---	Lifting Presser Bar Spring (heavy).....
32071	2195	Feed Dog for Japanese.....
32072	2195	Lifting Presser Foot Guide (Canton) with 19083.....
32073	2195	Lifting Presser Foot Guide (coarse Canton) with 19082.....
32083	2196	Spool Spindle for 32084.....
32084	---	Spool Spindle complete, Nos. 32083, 32086, 32087, 32089, 50159b and 50160c.....
32085	2196	Spool Spindle Washer (felt) for 32086.....
32086	2196	Spool Spindle Washer (steel) with 32085, for 32084.....
32087	2196	Thread Guiding Disc with two 32088, for 32084.....
32088	2196	Thread Guiding Disc Bushing for 32087.....
32089	2196	" " " Washer for 32084.....
*32096	---	Connecting Rod Cap for 32227.....
32098	7051	Feed Bar Hinge Pin for 32264.....
32110	7058	Needle Bar Bushing (lower) obsolete.....
32111	7058	Needle Bar Connecting Stud with 195E and 1296c.....
32112	7065	Spool Bracket with 1009c.....
32122	7054	Lifting Presser Bar Guide and Lifting Bracket with 390J.....
32124	7054	Lifting Presser Bar Lifting Arm with 223E and 1083c.....
32125	7054	Lifting Presser Bar Lifting Arm Disengaging Lever.....
32127	7055	Lifting Presser Bar Lifting Arm Disengaging Lever Shaft Crank with 175w.....

NO.	PLATE	NAME
32129	7055	Lifting Presser Bar Lifting Arm Shaft.....
32130	7055	“ “ “ “ “ “ Bush- ing.....
32136	7057	Lifting Presser Foot Guide (chip) for short stitch.....
32137	7057	Lifting Presser Foot Guide (tape) for short stitch.....
32144	7051	Arm Rock Shaft.....
32145	7052	“ “ “ Bushing (back).....
32146	7052	“ “ “ “ (front).....
32147	7052	“ “ “ Crank (back) with 1259c and 50275c.....
32148	7052	Arm Rock Shaft Crank (front) with 1266c and 50275c.....
32149	7051	Arm Rotary Shaft with 1019c.....
32150	7052	“ “ “ Bushing (back).....
32151	7052	“ “ “ “ (front).....
32152	7052	“ “ “ Collar with two 889c..
32155	7052	Face Plate.....
32156	7052	“ “ Thread Guard.....
32156	7052	Thread Eyelet (top of arm) obsolete, use 32279.....
32157	7051	Feed Bar with 440c, for 32264.....
32158	7053	“ “ Carrier with four 624c, for 32264
32159	7053	“ “ “ Hinge Pin.....
32160	7053	“ “ “ “ “ Bushing (left).....
32161	7053	Feed Bar Carrier Hinge Pin Bushing (right).....
32162	7067	Feed Bar Cover.....
32163	7053	“ Connecting Rod with 1012E, 32164 and two 896E.....
*32164	—	Feed Connecting Rod Cap for 32163.....
32165	7053	“ Dog Carrier for 32254.....
32166	7054	“ Eccentric with two 889c.....
32167	7054	“ Lifting Eccentric with two 889c....
32168	7054	“ “ “ Connection.....
32169	7054	“ “ “ “ Bar for 32264.....
32170	7054	Lifting Presser Bar.....
32171	7054	“ “ “ Lifter.....
32172	7055	“ “ “ Lifting Arm Disen- gaging Lever Shaft.....
32173	7055	Lifting Presser Bar Lifting Arm Position Spring.....
32174	7055	Lifting Presser Bar Lifting Arm Shaft Driving Lever with 1999.....

NO.	PLATE	NAME
32175	7055	Lifting Presser Bar Stud.....
32176	7056	“ “ Foot (narrow) for binding
32177	7056	“ “ “ (wide) for binding...
32178	7056	“ “ “ with Guide, for braid, for high rolled edge.....
32179	7056	Lifting Presser Foot with Guide and 32214 (wide Japanese).....
32180	7056	Lifting Presser Foot with Guide (coarse Canton).....
32181	7056	Lifting Presser Foot with Guide, for extra heavy braid.....
32182	7056	Lifting Presser Foot with Guide and 32268, for coarse braid.....
32183	7057	Lifting Presser Foot Guide (tape) for fine work.....
32185	7055	Looper Gate Lock Stud.....
32186	7058	Needle Bar (hollow) with 12495 and 32273
32190	7060	Plait Guide Block.....
32191	7058	Tension Disc.....
32192	7058	“ Regulator.....
32193	7058	“ “ Bushing.....
32194	7058	“ “ Friction Spring.....
32195	7058	“ “ Plate.....
32196	7058	“ Thread Guard.....
32197	7061	Thread Controller Bracket.....
32198	7061	“ “ Guide Plate.....
32199	7061	“ “ Spring (inside).....
32200	7061	“ “ “ (outside).....
32201	7061	“ Eyelet (side of arm).....
32202	7061	“ Pull-off Lever with 1933.....
32203	7061	“ “ “ Cam with two 465c, obsolete, use 19076.....
32204	7062	Throat Plate with 664J, 32205 and two 19078, for 19015, 19018, 19094 and 32071, obsolete, use 32256.....
32205	7062	Throat Plate Oil Hole Cover for 32204 and 32221, obsolete.....
32207	7066	Wrench for 50277 (Accessories).....
32208	7066	Lifting Lever for 32209.....
32209	—	Foot Lifter complete, Nos. 21b, 6439, 19081, 32208 and 59074.....
32210	7057	Lifting Presser Foot Adjusting Screw Washer, for 32213.....
32211	7057	Lifting Presser Foot Plate for 32213.....
32212	7057	“ “ “ Shank for 32213.....
32213	—	Lifting Presser Foot (adjustable) complete, Nos. 704J and 32210 to 32212.....

NO.	PLATE	NAME
32214	7056	Lifting Presser Foot Guide Stud for 32179
32217	7055	Looper Gate for 32218.....
32218	—	“ “ 32217 with 32219 and two 337J.....
32219	7055	Looper Gate Thread Guard for 32218....
32220	2195	Feed Dog for fine Milan tape.....
32221	7062	Throat Plate with 664J, 32205 and two 19078, for 32220, obsolete, use 32257...
32225	7051	Balance Wheel and Connecting Rod Eccentric Oil Pad (felt).....
32226	7052	Balance Wheel and Connecting Rod Eccentric Oil Pad Oil Hole Packing (braided cotton).....
32227	7051	Connecting Rod with 32096 and two 896E, for 32253.....
32228	—	Arm End Cover for 32229, obsolete.....
32229	7051	“ “ “ 32228 with 32230, obso- lete, use 32276.....
32230	—	Arm End Cover Belt Guard for 32229, obsolete.....
32231	7051	Balance Wheel and Connecting Rod Eccentric, 1 ³ / ₈ in. pulley. with 1285c, for 32267.....
*32233	—	Arm Extension for 32234.....
*32234	—	“ upper and lower (solid) with 32233 and two 1485E.....
32235	7054	Lifting Presser Bar Lifter Hinge Stud....
Nos. 32236 to 32240 for 32241		
32236	7059	Plait Guide (lower).....
32237	7059	“ “ (upper).....
32238	7059	“ “ “ Holder with 54705....
32239	7059	“ “ “ Lock Stud.....
32240	7059	“ “ “ “ “ Spring....
32241	—	Plait Guide complete, Nos. 89c, 208E, 32236 to 32240, 32262 and 50117E....
32242	7059	Plait Guide (stationary) Nos. 32243 and 32244.....
32243	7059	Plait Guide (stationary) Bracket with 735c, for 32242.....
32244	7059	Plait Guide (stationary) Rod for 32242..
32245	7067	Machine Base with 25761, 32247 and three each 32246 and wood screws 1 in. No. 14
32246	7064	Machine Cushion (felt) round, for 32245..
32247	7064	“ “ oblong, for 32245..
32253	—	Connecting Rod 32227 with 1520J and 50276c, for 32267.....

NO.	PLATE	NAME
32254	—	Feed Dog Carrier 32165 with 995c.....
32255	7064	Needle Bar Bushing (lower).....
32256	7062	Throat Plate with 662J, 32258, 32259 and two 19078, for 19015, 19018, 19094 and 32071.....
32257	7062	Throat Plate with 662J, 32258, 32259 and two 19078, for 32220.....
32258	7062	Throat Plate Oil Hole Cover for 32256 and 32257.....
32259	7062	Throat Plate Oil Hole Cover Spring for 32256 and 32257.....
32262	7064	Plait Guide (upper) Friction Washer for 32241.....
32264	—	Feed Bar 32157 with 32098, 32158 and 32169.....
32266	—	Tension Screw Stud 50279c with 1712c...
32267	—	Balance Wheel and Connecting Rod Eccentric 32231 with 32253.....
32268	—	Lifting Presser Foot Guide Stud for 32182.
32273	7064	Needle Bar (thread eyelet) Extension for 32186.....
32275	—	Arm End Cover for 32276.....
32276	7073	“ “ “ 32275 with 32277.....
32277	—	“ “ “ Belt Guard for 32276....
32279	7064	Thread Eyelet (top of arm).....
32572	7058	Tension Spring Washer.....
34170	7058	Needle Bar Connecting Link with two 1313E.....
34418	7055	Looper Washer for 19048.....
36006	7055	“ Gate Friction Washer.....
42290	7064	Feed Regulating Screw Stud Washer....
50117E	7059	Plait Guide (upper) Lock Stud Spring Screw for 32241.....
50159B	2196	Thread Guiding Disc Cap Screw for 32084
50160c	2196	“ “ “ Screw Stud for 32084
50161c	7055	Lifting Presser Foot Screw.....
50275c	7052	Arm Rock Shaft Crank (back) Position Screw for 32147.....
50275c	7052	Arm Rock Shaft Crank (front) Position Screw for 32148.....
50276c	7063	Connecting Rod Hinge Screw for 32253..
50277c	7054	Feed Regulating Screw Stud.....
50278J	7063	Lifting Presser Bar Pressure Regulating Thumb Screw.....
50279c	7058	Tension Screw Stud for 32266.....
50280J	7063	Machine Thumb Screw for Power Table (Accessories).....

NO.	PLATE	NAME
51807	7055	Lifting Presser Bar Roller and Screw Stud.
51808	7058	Tension Sere x Stud Roller.
54705	7059	Plait Guide (upper) Steady Pin for 32238.
56864	7064	Chain Hook (large) for 6439.
56865	7064	" " (small) for 6439.
59051	7067	Treadle for 59074.
59074	7067	Treadle complete, for 32200, Nos. 4879, 7585, 14357, 59051 and two wood sereas 1 1/4 in. No. 12.
120344	7066	Oiler (copper plated) with 120345 (Acces- sories).
120345	7066	Oiler Spout, 5 in. long, for 120344.
200383c	7064	Thread Unwinder Spool Rest Rod Set Screw for 202490.
201018c	7064	Thread Unwinder Spool Rest Set Screw for 225389.
201696j	7064	Thread Unwinder Thread Guide Lock Nut for 225394.
202490	8523	Thread Unwinder Spool Stand with 200383c, for 225394.
Nos. 225388 to 225392 for 225394		
225388	8523	Thread Unwinder Spool Rest Rod.
225389	8523	" " " " with 201018c
225390	---	" " Thread Cone Holder, for inverted cones.
225391	8523	Thread Unwinder Thread Guide.
225392	8523	" " " " Rod with 208E and 225393.
225393	7064	Thread Unwinder Thread Guide Rod Washer for 225392.
225394	8523	Thread Unwinder complete, for one spool, Nos. 201696j, 202490, 225388, 225389, 225391, 225392 and three wood screws 3/8 in. No. 12.

Genuine Singer Needles and their Con-
tainers are marked with the Company's
Trade Mark "SIMANCO." 1

Needles in Containers marked
"For Singer Machines"
are not Singer made needles. 2

ILLUSTRATIONS OF PARTS

FOR

MACHINE No. 25-56

28835

19036

28834

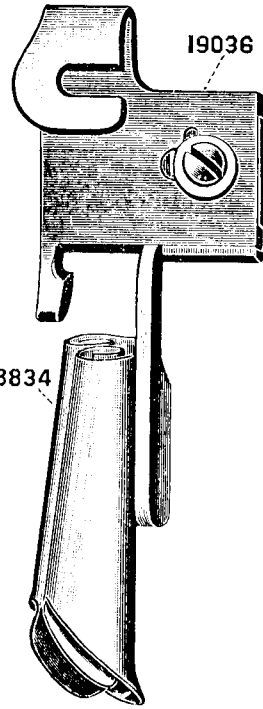

ILLUSTRATIONS OF PARTS

MACHINE No. 25-26

Machine, Hook, Needle and their Components are marked with the Company Trade Mark "SINGAPORE"

Needles in Components marked "The Singer Machine" are not fitted in this machine

PLATE 2195—FULL SIZE

19040

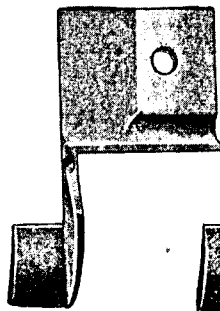

19041

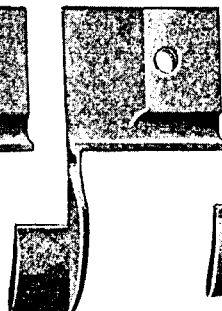

19095

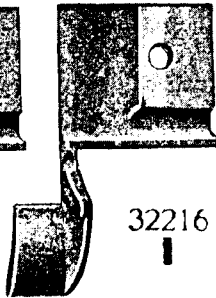

32216



19042

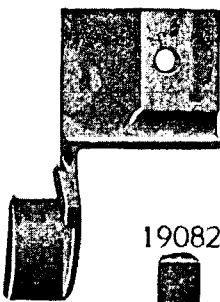

19043

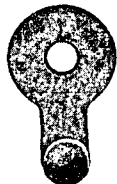

19044



19045



19082



19083



19046



1003



19015

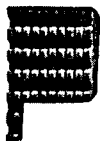

19094



19018



32071



32220



32072

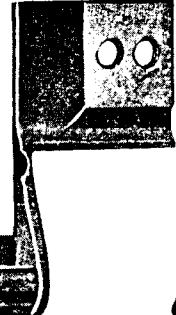

32073

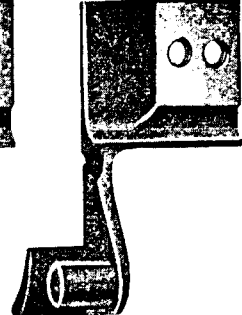
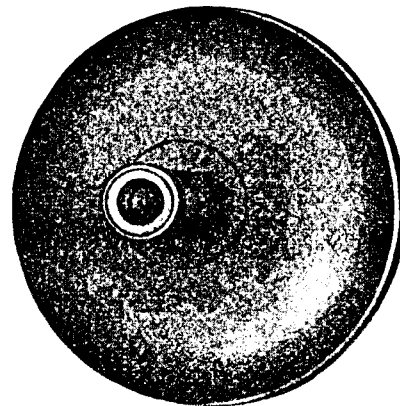

PLATE 2196—FULL SIZE

32083



32087



32089



32088



50159



32086

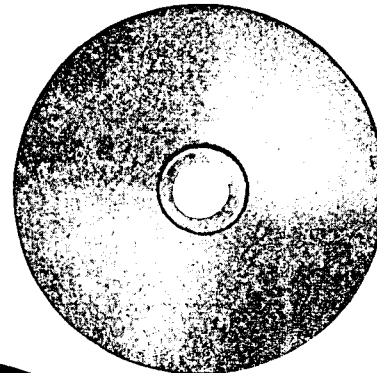

1009



32085

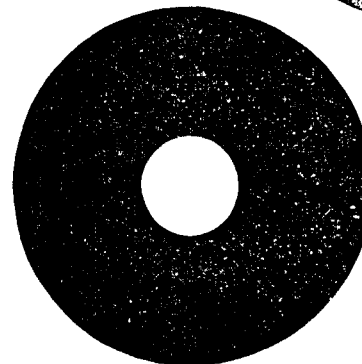

50160

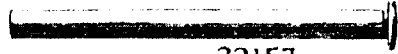

PLATE 7051—ONE-HALF SIZE

32149



32098



32157

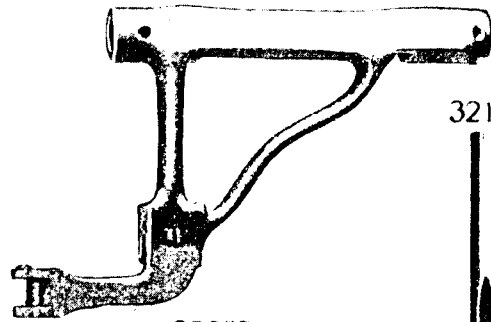

32144



32229

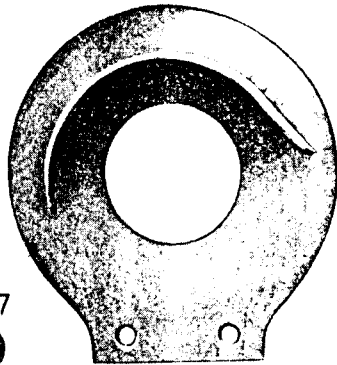

32227

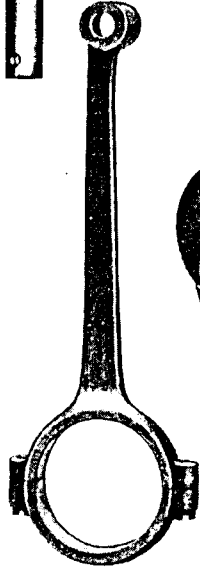

32231

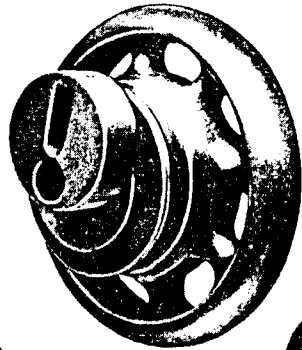

32225

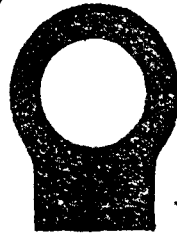
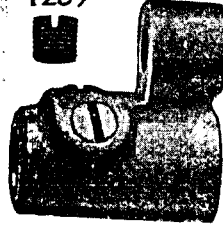

PLATE 7052—FULL SIZE

1259



32147



32145



50275



32146



462



32148

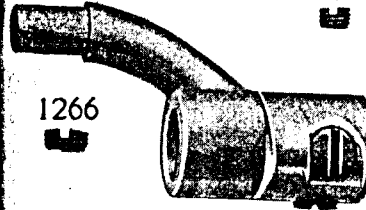

1266



624



889



32150

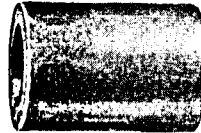

32155

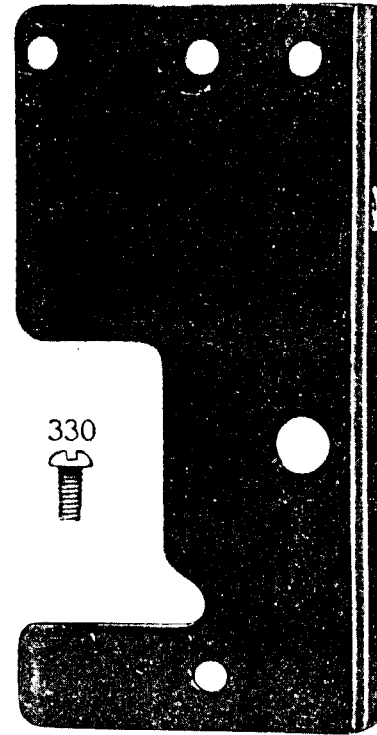

32151



32152



32226



32156



330



PLATE 7053—FULL SIZE

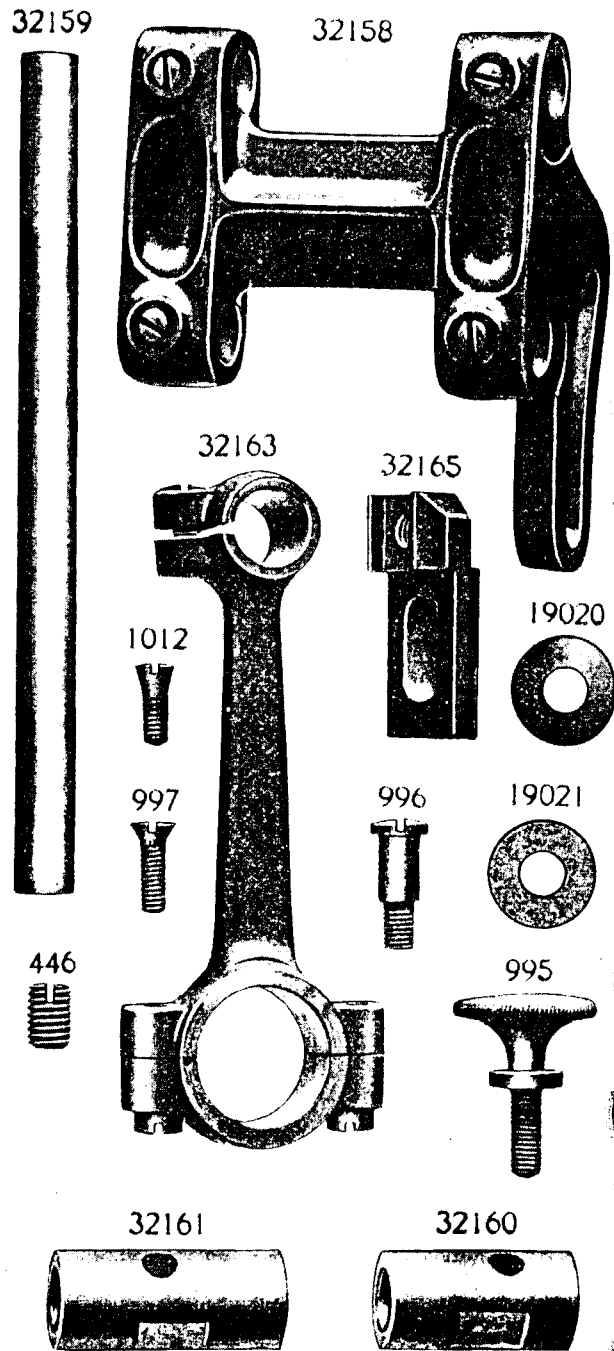

PLATE 7054—FULL SIZE

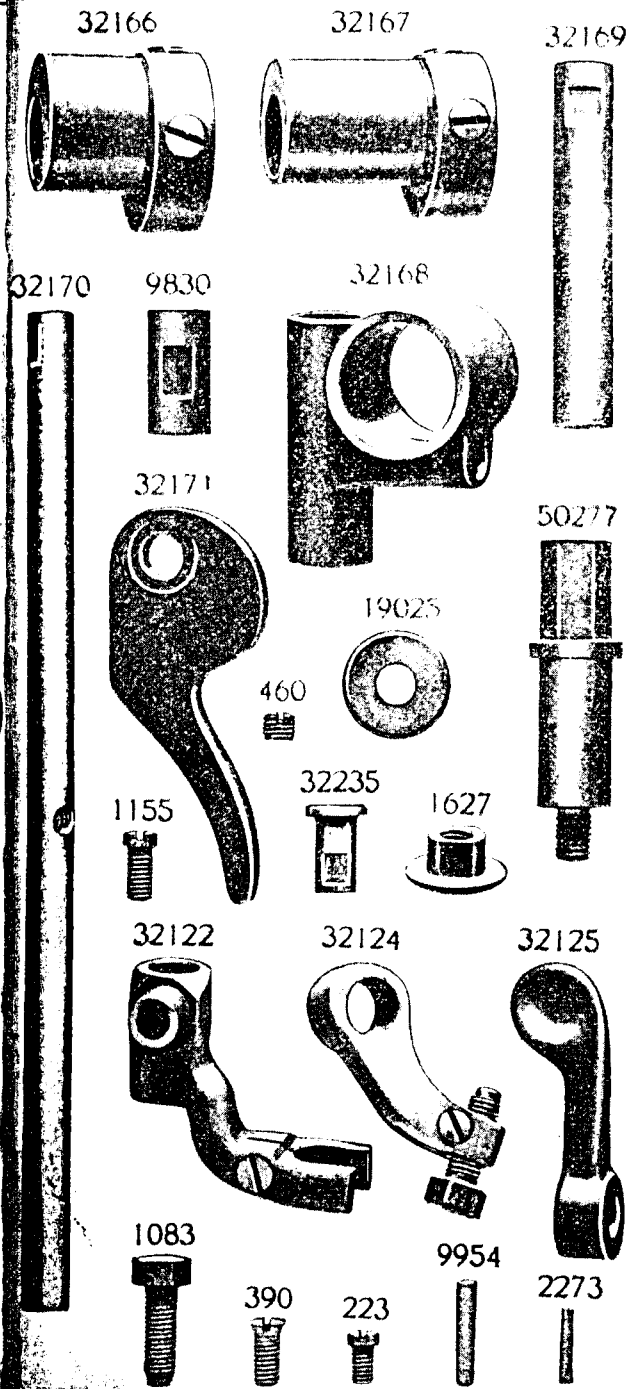

PLATE 7055—FULL SIZE

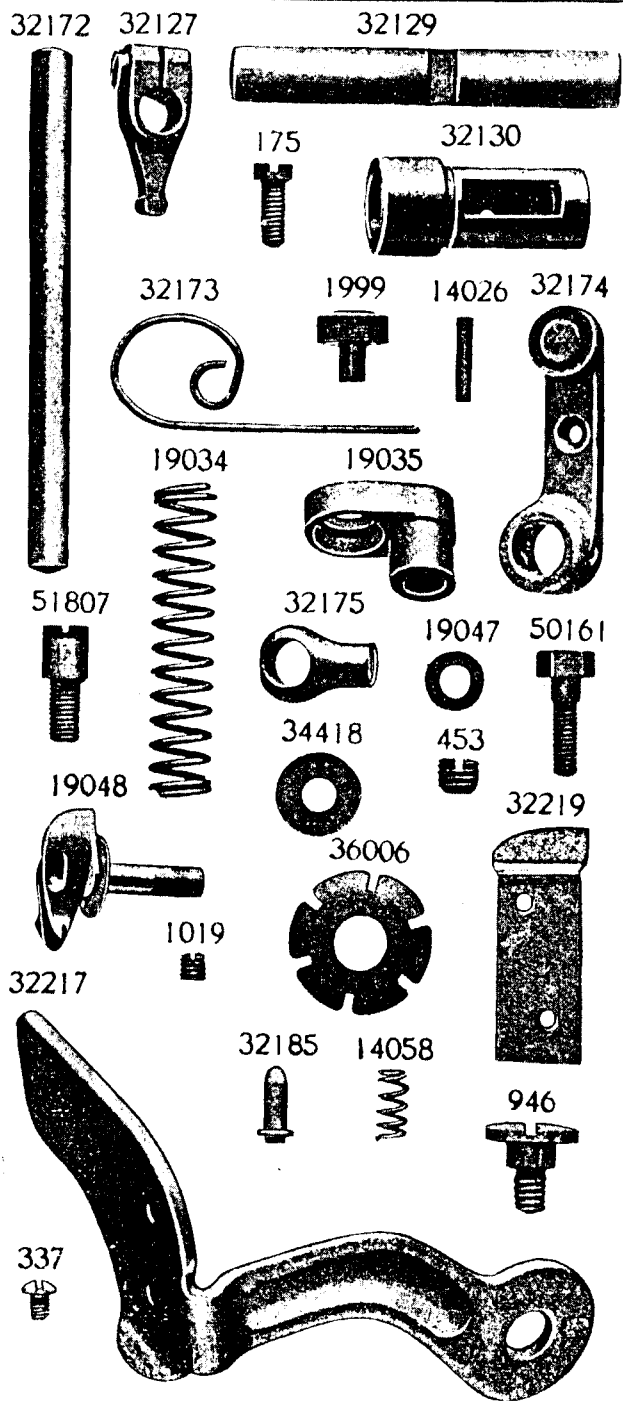

PLATE 7056—FULL SIZE

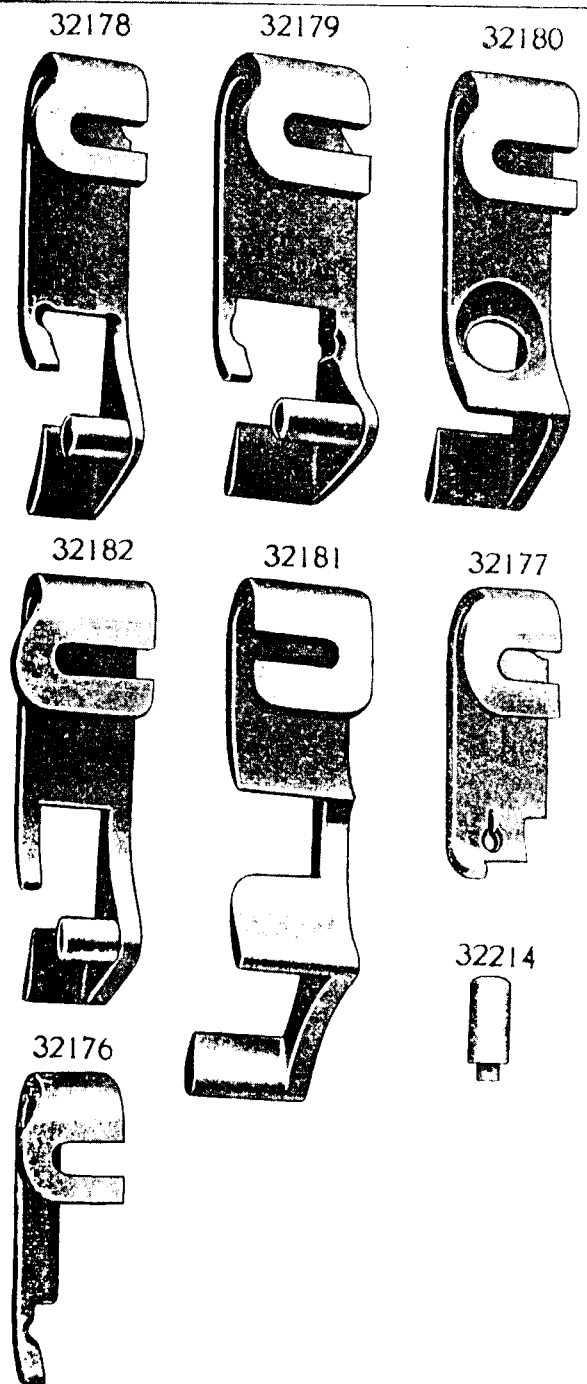

PLATE 7057—FULL SIZE

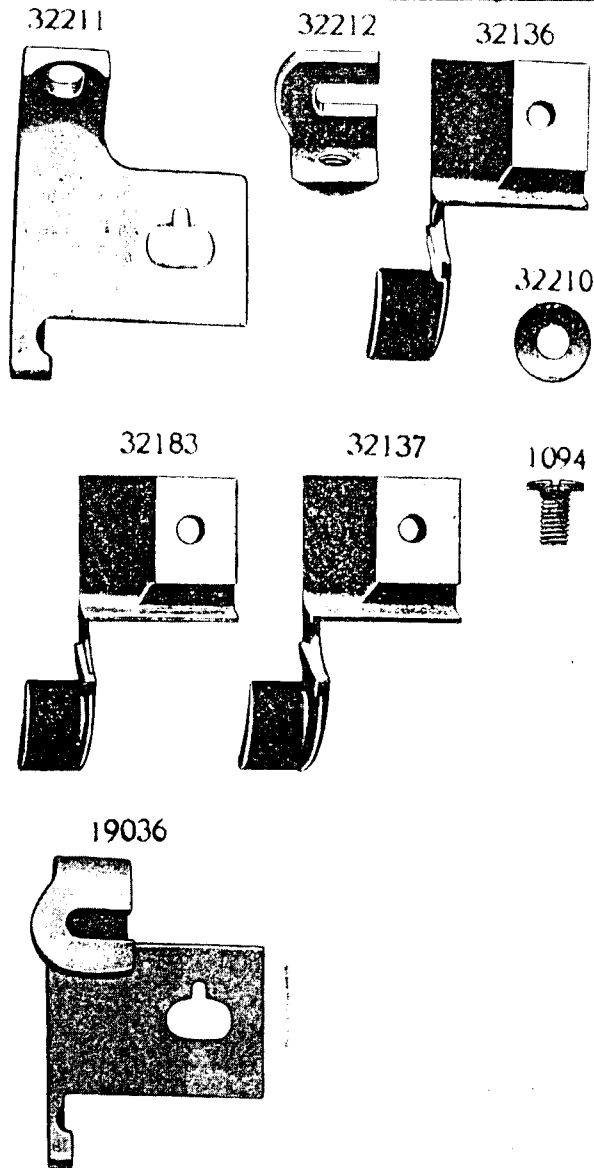

PLATE 7058—FULL SIZE

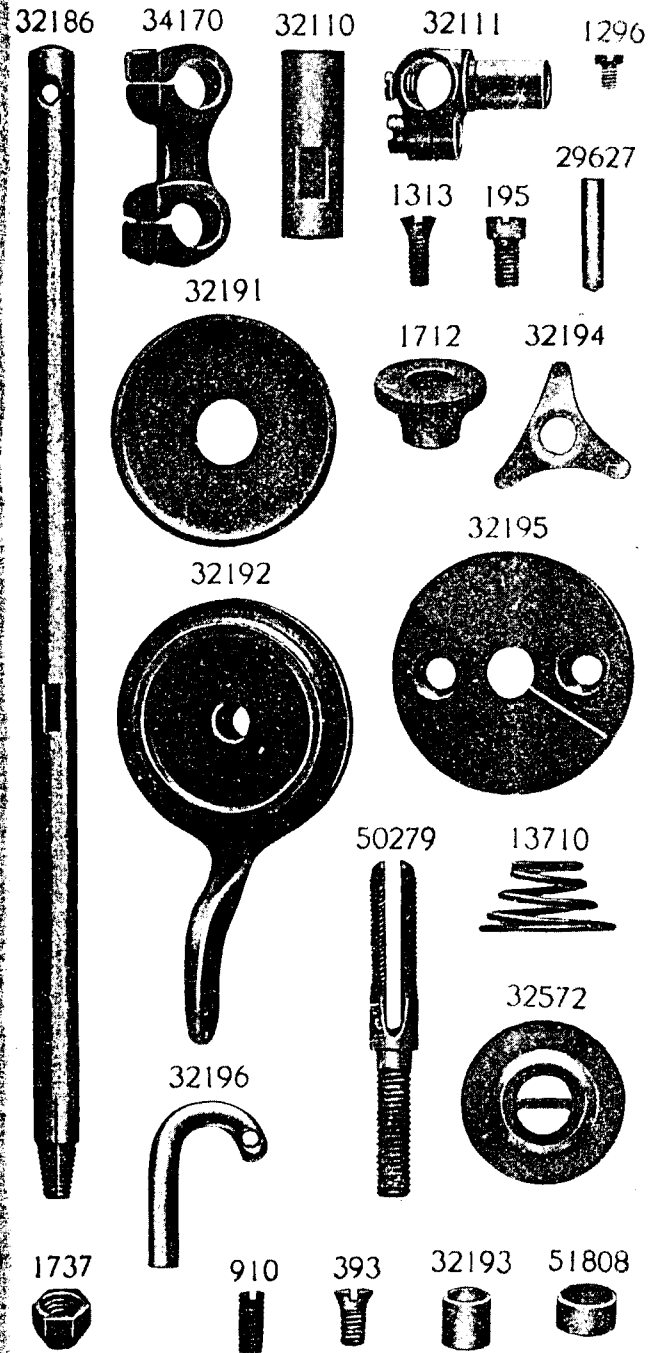
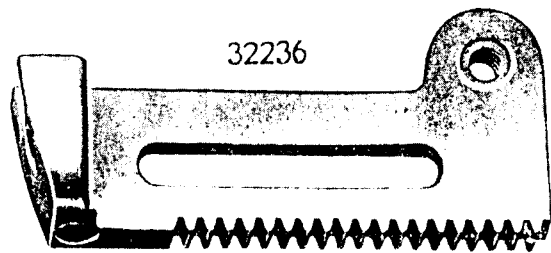
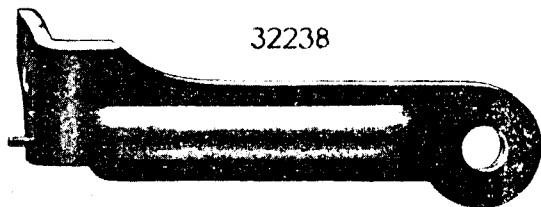

PLATE 7059—FULL SIZE

PLATE 7060—FULL SIZE



32236



32238

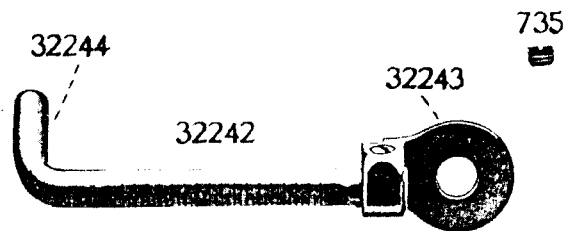

32244

32242

32243

735



32237

32240

32239



50117



89

54705

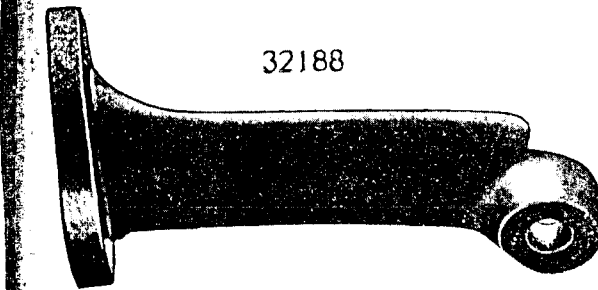

32188

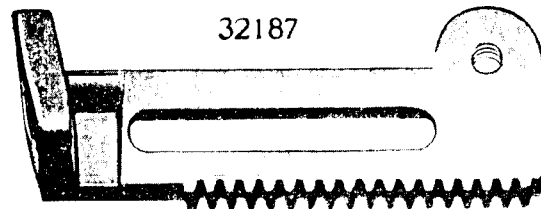

32187

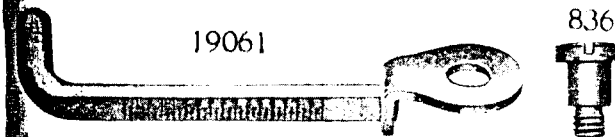

19061

836

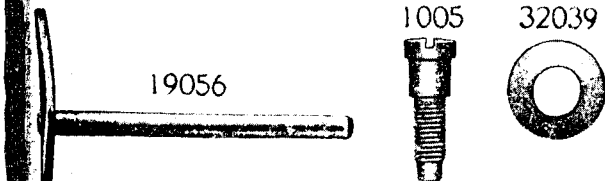

19056

1005

32039

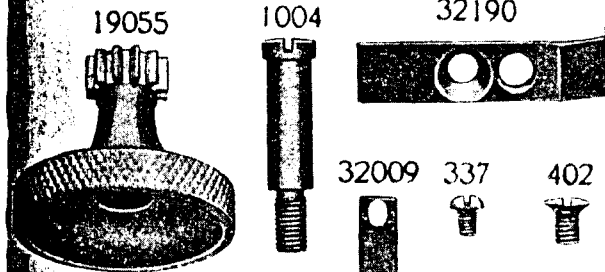

19055

1004

32190

32009

337

402

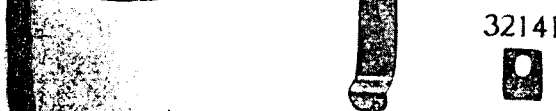

32141

PLATE 7061—FULL SIZE

PLATE 7062—FULL SIZE

32197 32198 32199 32200 32201

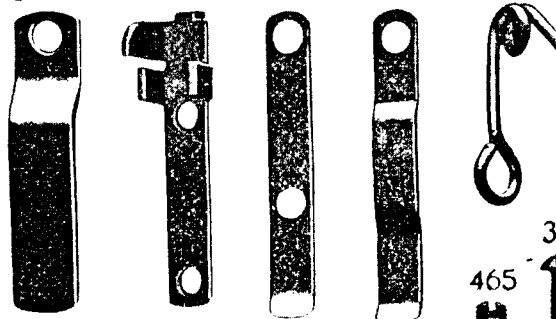

19071

32202

32203

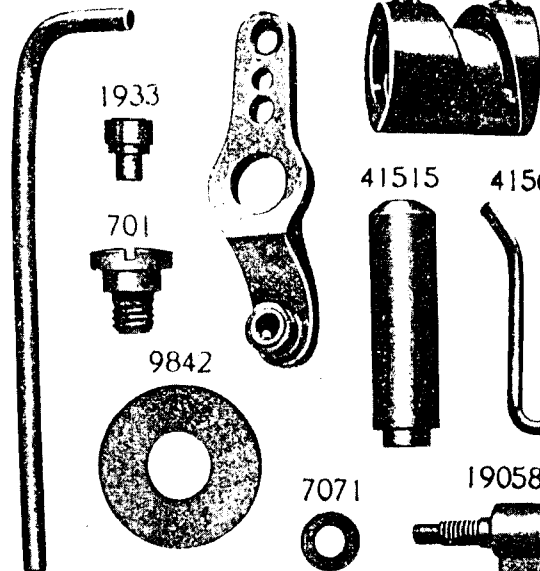

1933

701

9842

41515

41569

7071

19058

2015

19081

19057

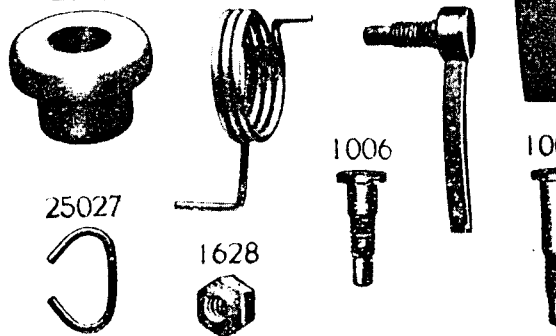

25027

1628

1006

1007

32257

33

465

32256

32221

32204

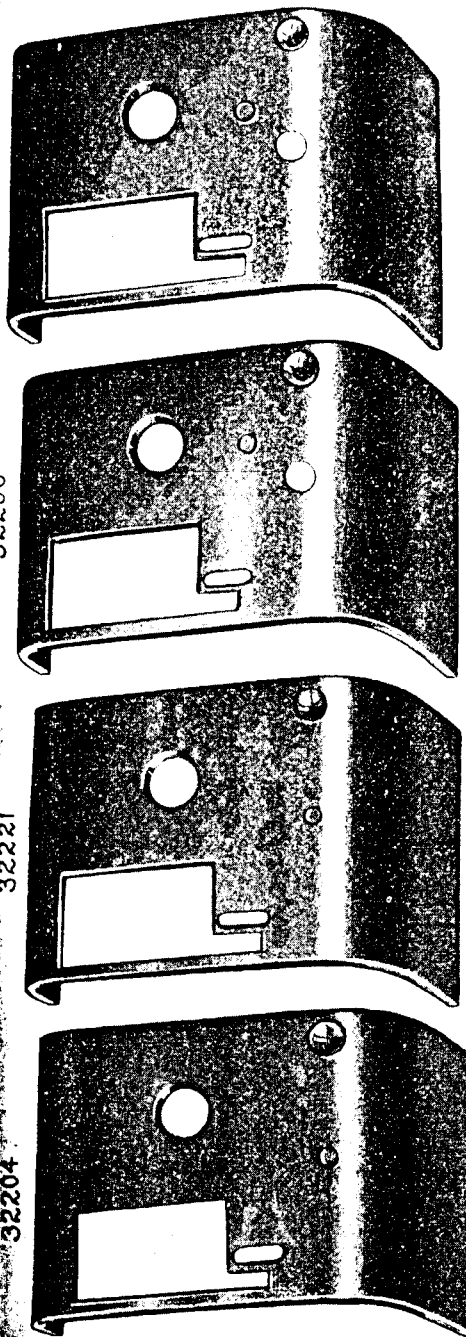

32258

32259

1011

662

19078

664

32205

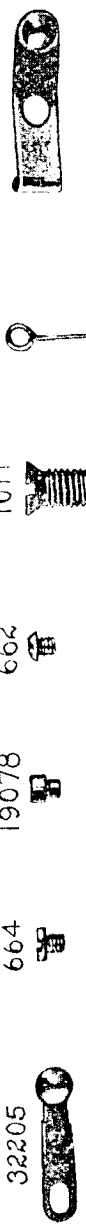

PLATE 7063—FULL SIZE

PLATE 7064—FULL SIZE

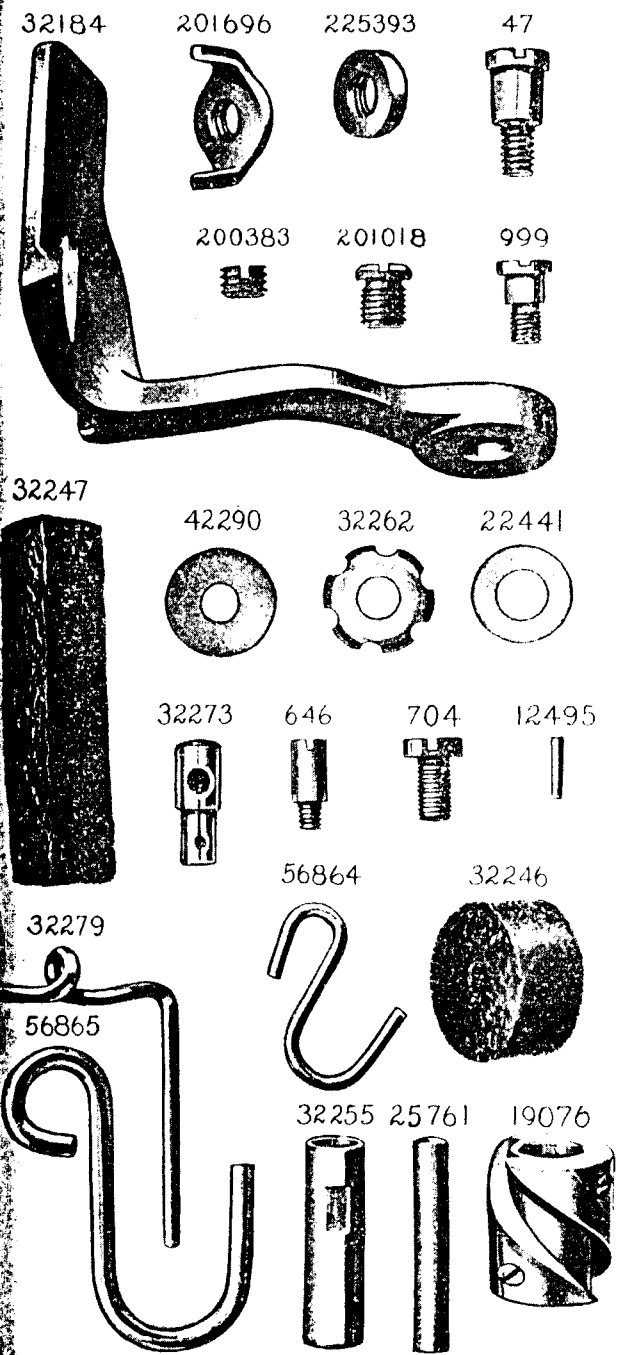
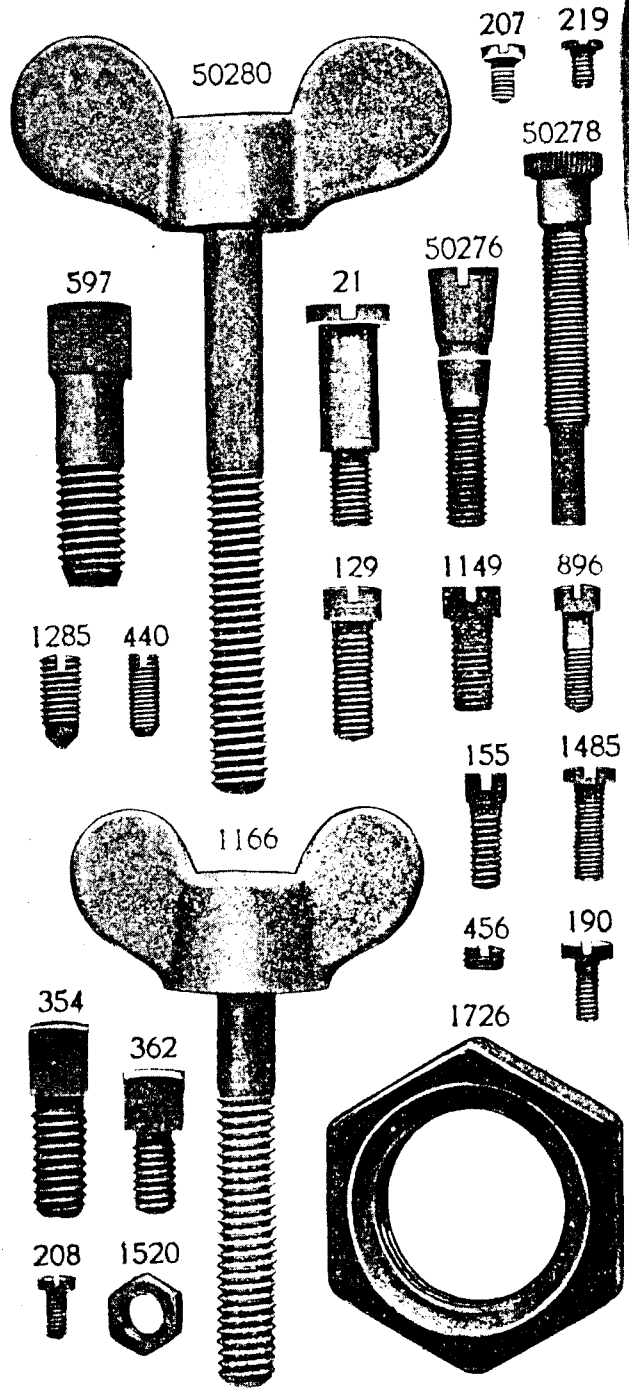
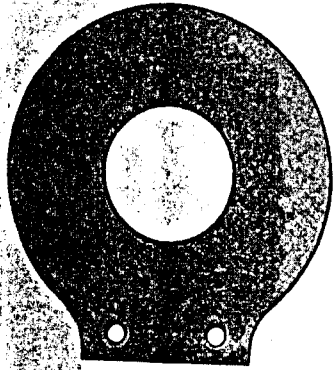
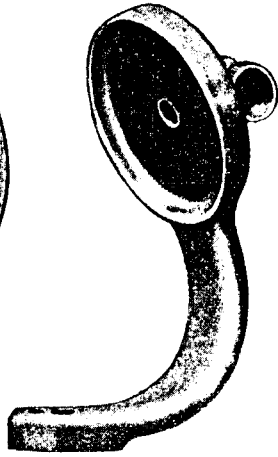

PLATE 7065—ONE-HALF SIZE

32091



32112



32153

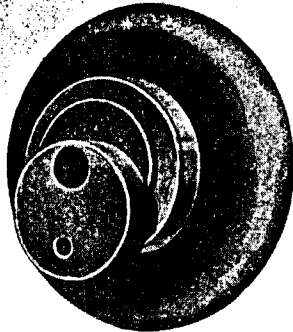

32154

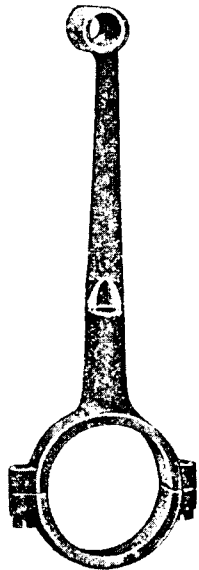

32224

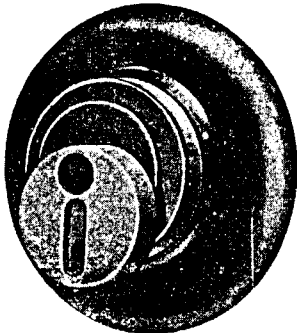

PLATE 7066—ONE-HALF SIZE

26485



26026



32207



120344

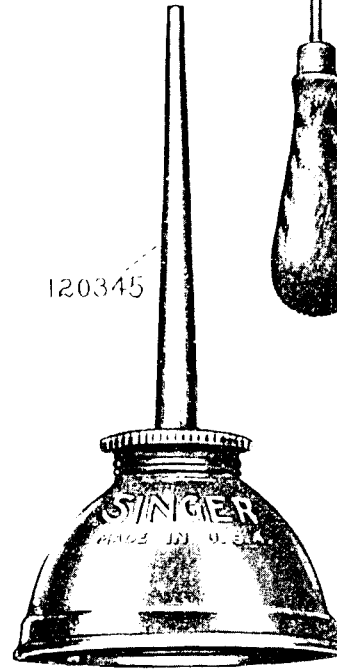

120345

19079



32208



4879



7585

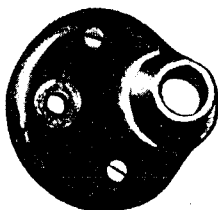

PLATE 7067—ONE-FOURTH SIZE

41046



41045



32162

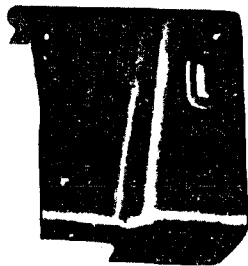

32245

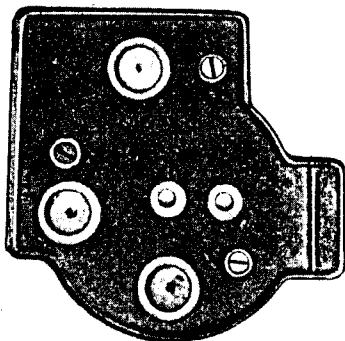

41044

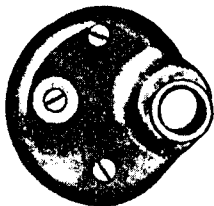

59074

59051

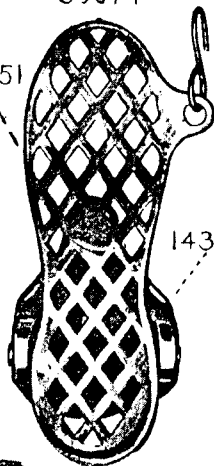

14357

32206

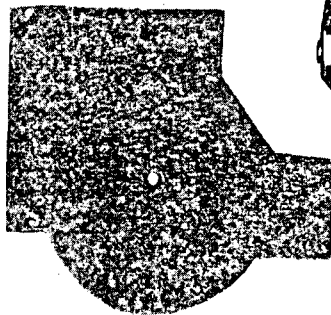
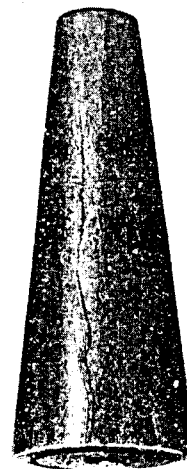

PLATE 7073—ONE-HALF SIZE

27739



32276

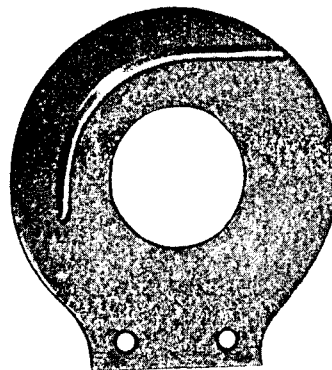

PLATE 8523—ONE-SIXTH SIZE

