

Form 20924
(1057)
Printed in U.S.A.

LIST
OF
PARTS
FOR FAMILY SHOPS



SINGER^{**}
MACHINES
Nos. 15-125 and 15-126

THE SINGER MANUFACTURING COMPANY

** A Trademark of THE SINGER MANUFACTURING COMPANY

PROPERTY OF
THE SINGER MANUFACTURING COMPANY

This is a private and confidential communication to and for the use of only the employees of The Singer Manufacturing Company and its affiliated companies. Reproduction, sale, distribution, or publication thereof to the public is forbidden.

INDEX

	Page
Accessories	24
Attachment Set	27
Bias Gauge	25
Bobbin Winder	24
Braider	25
Controllers (Foot)	20
Controllers (Foot or Knee)	18
Feller (Foot)	25
Finger Guard	25
Hemmer (Foot)	25
Hemstitcher	25
Light	23
Light Lamp	24
Machine No. 15-125	7
Machine No. 15-126	13
Motor Parts	15
Numerical List of Parts	29
Presser Feet	25
Presser Feet with Adjustable Guides	26
Quilter	26
Ruffler Shirring Plate	26
Seam Guide	26
Special Attachments	28
Stiletto	26
Underbraider	27

INSTRUCTIONS FOR ORDERING

In ordering from this list, use **ONLY** the part NUMBER in the **FIRST** column.

The number stamped on a Sewing Machine Part is in every case the number of the single part only.

Every combination of parts sent out as such has its specific number, which, although not stamped on the parts, must be used when ordering the combination.

Each number always indicates the **SAME PART** in whatever list it appears, or for whatever machine.

The letters after some of the numbers indicate the style of finish only, as follows:

- A—Hardened, Polished, Nickel Plated and Buffed
- B—Polished, Nickel Plated and Buffed
- C—Hardened Only
- D—Polished Only
- E—Soft, Not Polished
- F—Hardened and Polished
- G—Bright Rumbled and Nickel Plated
- H—Blued
- J—Nickel Plated Only
- K—Hardened and Nickel Plated
- L—Brass Plated
- M—Oxidized
- R—Phosphate Coating Formed on Surface of Iron or Steel
- S—Cadmium Plated
- T—Copper Plated
- U—Zinc Plated
- V—Silver Plated
- W—Polished and Nickel Plated
- X—Black Oxide for Iron and Steel
- Y—Black Nickel Plated Only
- Z—Chromium Plated
- A.A—Buffed and Chromium Plated
- A.B—Hardened, Polished, Buffed and Chromium Plated
- A.E—Hardened, Bright Rumbled and Nickel Plated
- A.F—Hardened, Bright Rumbled, Nickel Plated, Bright Rumbled and Chromium Plated
- A.G—Alumilite (Plain)
- A.H—Alumilite (Dyed) Color Must be Stated
- A.J—Polished, Nickel Plated and Chromium Plated
- A.K—Hardened, Polished, Nickel Plated and Chromium Plated
- A.L—Heat Treated for Toughness
- A.L.D—Heat Treated for Toughness and Polished
- A.L.X—Heat Treated for Toughness and Black Oxide

INSTRUCTIONS FOR ORDERING

- A.S—Black Moulded Phenolic
- A.T—Beige Moulded Phenolic
- A.U—Brown Moulded Phenolic
- A.W—Hardened then Flame Coated with Tungsten Carbide
- B.A—Chrome Nickel Satin Finish
- B.B—Hardened and Chrome Nickel, Satin Finished
- C.R—Hardened and Phosphate Coating Formed on Surface of Steel
- F.J—Hardened, Polished and Nickel Plated
- T.A—Hardened, Polished, Copper and Nickel Plated and Buffed
- T.B—Copper and Nickel Plated and Polished
- T.J—Copper and Nickel Plated Only
- T.K—Hardened, Copper and Nickel Plated
- T.L—Copper and Brass Plated
- T.M—Copper Plated and Oxidized
- X.C—Hardened and Black Oxide for Iron and Steel
- Z.A—Hardened, Polished Nickel Plated, Buffed and Chromium Plated
- Z.B—Polished, Nickel Plated, Buffed and Chromium Plated
- Z.C—Hardened and Chromium Plated
- Z.D—Polished and Chromium Plated
- Z.G—Bright Rumbled, Nickel Plated, Bright Rumbled and Chromium Plated
- Z.J—Nickel and Chromium Plated
- Z.T—Copper and Chromium Plated

These letters **MUST BE USED** when they appear in the list; and **AFTER** the number as in the list.

In this series:

1 to 1500, 50001 to 51500 and 140001 to 142,000 are screw numbers
1501 to 1800 and 51500 to 51800 are nut numbers
1801 to 2000 and 51801 to 52000 are roller numbers
2001 to 50000 and 52001 to 140000 and 142001 to 190000 are Sewing Machine Parts, 190001 and upward are numbers of Electrical Parts.

The figures in the second column refer only to the plates, illustrating the parts, and are **NOT TO BE USED** in ordering.

Parts marked with an asterisk (*) are furnished only when repairs are made at the factory.

LIST OF PARTS COMPLETE
FOR

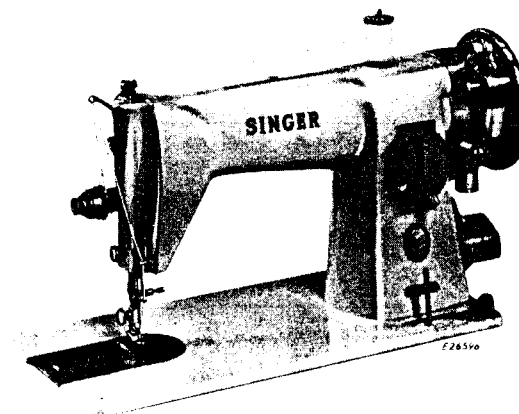

MACHINE NO. 15-125

No.	Plate	Name
171531	-----	Arm with 435AL, 15498, 81110, 125331, 125334, Trade Mark, Number Plate and four 140543L.....
		NOTE: When ordering No. 171531 color required, must be specified.
171532	-----	Arm and Bed Nos. 125255, 171531, two 2002 and three 138E.....
		NOTE: When ordering No. 171532 color required, must be specified.
2002	26100	Arm Dowel Pin (2).....
125331	26100	Arm Oil Pad (felt) for oiling Arm Shaft Back Bearing.....
81110	26100	Arm Oil Pad Spring.....
125334	26100	Arm Oil Pad Spring Cap.....
138E	26100	Arm Screw (3).....
125253	26100	Arm Shaft.....
125254	-----	Arm Shaft 125253 with 15434, 15498 and 125045.....
15498	26100	Arm Shaft Bushing.....
435AL	26100	Arm Shaft Bushing Set Screw.....
125466	26001	Arm Side Cover.....
		NOTE: When ordering No. 125466, color required, must be specified.
51224ZB	26001	Arm Side Cover Thumb Screw.....
2007ZG	26101	Arm Spool Pin.....
8879	26101	Arm Spool Pin Washer (cloth).....
		NOTE: When ordering No. 8879, color required, must be specified.

No.	Plate	Name
*125255	-----	Bed.....
51280ZB	26100	Clamp Stop Motion Clamp Screw.....
246ZA	26100	Clamp Stop Motion Clamp Stop Screw.....
171505J	26100	Clamp Stop Motion Clamp Washer.....
125360	-----	Clamp Stop Motion Flanged Bushing.....
125372	26100	Clamp Stop Motion Flanged Bushing 125360 with two 462AL.....
462AL	26100	Clamp Stop Motion Flanged Bushing Set Screw (2).....
125021	26100	Crank Connecting Rod with 125044 and two 896AL.....
896AL	26100	Crank Connecting Rod Cap Screw (2).....
375C	26100	Crank Connecting Rod Hinge Screw.....
1518R	26100	Crank Connecting Rod Hinge Screw Nut...
125044	26100	Crank Connecting Rod Oil Pad (felt).....
125482	26101	Face Plate with 15410, and 125472..... NOTE: When ordering No. 125482, color required, must be specified.
125483	26101	Face Plate 125482 with 857ZB, 50292ZB, and 125317..... NOTE: When ordering No. 125483, color required, must be specified.
125484	26101	Face Plate complete, Nos. 125418 and 125483..... NOTE: When ordering No. 125484, color required, must be specified.
125470	-----	Face Plate Thread Guard.....
125472	26101	Face Plate Thread Guard 125470 with 125373.....
125373	-----	Face Plate Thread Guard Rivet.....
51224ZB	26101	Face Plate Screw (lower).....
51354J	26101	Face Plate Screw (upper).....
2835	26103	Feed Bar.....
315C	26103	Feed Bar Screw Center (2).....
15445	-----	Feed Bar Screw Center 315C with 1519R (2).....
1519R	26103	Feed Bar Screw Center Nut (2).....
125386	26103	Feed Bar Throw-out Lever with 1813....
125349	26103	Feed Bar Throw-out Lever Retaining Ring.....
1904	26103	Feed Bar Throw-out Lever Roller.....
1813	-----	Feed Bar Throw-out Lever Roller and Stud, Nos. 1904 and 125060.....
125060	-----	Feed Bar Throw-out Lever Roller Stud...
125387	-----	Feed Bar Throw-out Lever Spring.....
51289X	26103	Feed Bar Throw-out Lever Thumb Screw..
125045	26100	Feed Cam and Counterbalance with 1285AL.....
1285AL	26100	Feed Cam and Counterbalance Position Screw.....
125261	26102	Feed Dog, 12 teeth (14 teeth to the inch) for 173585.....
208AL	26102	Feed Dog Screw (2).....
125262	26100	Feed Forked Connection with 175R.....

No.	Plate	Name
125340	-----	Feed Forked Connection 125262 with 125335.....
175R	26100	Feed Forked Connection Adjusting Screw..
51252C	26100	Feed Forked Connection Hinge Screw (eccentric).....
1520R	26100	Feed Forked Connection Hinge Screw Nut.
125047	26100	Feed Forked Connection Slide Block.....
125335	-----	Feed Forked Connection Slide Block 125047 with 1085E.....
1085E	26100	Feed Forked Connection Slide Block Screw Stud.....
125263	26103	Feed Lifting Rock Shaft.....
125388	26103	Feed Lifting Rock Shaft Crank with 157R..
157R	26103	Feed Lifting Rock Shaft Crank Clamping Screw.....
125389	-----	Feed Lifting Rock Shaft Crank complete, Nos. 51289X, 125386, 125387 and 125388.....
125390	-----	Feed Lifting Rock Shaft complete, Nos. 125263, 125349 and 125389.....
304C	26103	Feed Lifting Rock Shaft Screw Center (2)..
125344	-----	Feed Lifting Rock Shaft Screw Center 304C with 1513R (2).....
1513R	26103	Feed Lifting Rock Shaft Screw Center Nut (2).....
125397	26100	Feed Regulator.....
125398	-----	Feed Regulator 125397 with 125381.....
50353E	26100	Feed Regulator Hinge Screw.....
125399	26100	Feed Regulator Hinge Screw Friction Washer.....
45305	26001	Feed Reversing Handle.....
125381	-----	Feed Reversing Handle 45305 with 1550R..
1550R	26001	Feed Reversing Handle Lock Nut.....
125270	26103	Feed Rock Shaft.....
304C	26103	Feed Rock Shaft Screw Center (2).....
125344	-----	Feed Rock Shaft Screw Center 304C with 1513R (2).....
1513R	26103	Feed Rock Shaft Screw Center Nut (2)...
125458	26100	Hand Wheel..... NOTE: When ordering No. 125458, color required, must be specified.
125459	-----	Hand Wheel 125458 with 125354, 125358, 125460, 125461 and two 125385..... NOTE: When ordering No. 125459, color required, must be specified.
125460	26100	Hand Wheel Gear.....
125461	26100	Hand Wheel Gear Retainer.....
125354	26100	Hand Wheel Gear Spring.....
125385	26100	Hand Wheel Gear Spring Cushion Pin (eccentric) (2).....
125358	26100	Hand Wheel Spring Stud.....
51045AL	26100	Machine Hinge Connection Set Screw (2)..
125377	26104	Needle Bar.....
125273	26104	Needle Bar Bushing with 125274.....
125274	26104	Needle Bar Bushing Oil Pad (felt).....

No.	Plate	Name
1498AL	26104	Needle Bar Bushing Set Screw.....
15248	26104	Needle Bar Connecting Link with 51002E .
125275	-----	Needle Bar Connecting Link 15248 with 125276
51002E	26104	Needle Bar Connecting Link Adjusting Screw.....
570C	26100	Needle Bar Connecting Link Hinge Screw.
1520R	26100	Needle Bar Connecting Link Hinge Screw Nut.....
125276	26104	Needle Bar Connecting Stud with 1341AL .
1341AL	26104	Needle Bar Connecting Stud Set Screw....
45334	26104	Needle Clamp Body with 140545ZC.....
45285	-----	Needle Clamp Body 45334 with 51308ZJ ..
125378	26104	Needle Clamp Gib and Thread Guard.....
51308ZJ	26104	Needle Clamp Position Screw.....
140545ZC	26104	Needle Clamp Thumb Screw.....
140543L	-----	Number Plate Drive Screw (2)
125280	26103	Oscillating Rock Shaft with 125056.....
125048	26103	Oscillating Rock Shaft Center (left).....
51246AL	26103	Oscillating Rock Shaft Center (left) Set Screw.....
125049	26103	Oscillating Rock Shaft Center (right).....
51246AL	26103	Oscillating Rock Shaft Center (right) Set Screw
125056	26103	Oscillating Rock Shaft Oil Wick (braided cotton)
125500	26103	Oscillating Shaft.....
125284	26103	Oscillating Shaft Crank with 125330 and two 462AL
462AL	26103	Oscillating Shaft Crank Set Screw (2)....
125330	26103	Oscillating Shaft Crank Slide Block
125061	26104	Presser Bar.....
125474	26104	Presser Bar Lifter
15486	26104	Presser Bar Lifter Hinge Stud
140712AL	26104	Presser Bar Lifter Hinge Stud Set Screw.
80011	26104	Presser Bar Spring.....
2068	26104	Presser Bar Spring Bracket with 453AL.
453AL	26104	Presser Bar Spring Bracket Set Screw... 2070 26104 Presser Bar Spring Washer.....
45321	26102	Presser Foot (hinged)
51224ZB	26102	Presser Foot Thumb Screw.....
51228ZJ	26104	Pressure Regulating Thumb Screw.....
66773	-----	Pressure Regulating Thumb Screw 51228ZJ with 66752
66752	26104	Pressure Regulating Thumb Screw Plug (felt wick)
125453	26105	Shuttle Bobbin.....
125287	26105	Shuttle Bobbin Case Latch
125320	26105	Shuttle Bobbin Case Latch Lever
2974	26105	Shuttle Bobbin Case Latch Lever Fulcrum Pin.....
2975	26105	Shuttle Bobbin Case Latch Spring.....
592E	26105	Shuttle Bobbin Case Latch Stop Screw....
125288	26105	Shuttle Bobbin Case Hinge, Nos. 2974, 125287 and 125320

No.	Plate	Name
125290	26105	Shuttle Bobbin Case Position Plate.....
391R	26105	Shuttle Bobbin Case Position Plate Screw (2).....
125291	26105	Shuttle Bobbin Case complete, Nos. 591F, 592E, 2975, 125288 and 125293.....
125292	26105	Shuttle Body.....
591F	26105	Shuttle Tension Regulating Screw.....
125293	26105	Shuttle Tension Spring.....
125294	26105	Shuttle 1 11/16 in. diam., Nos. 125291, 125292 and 125453
125297	26103	Shuttle Driver with two 1253AL.....
125322	-----	Shuttle Driver, 125297 with 125298 and two 51229E
125298	26103	Shuttle Driver Cushion Spring.....
51229E	26103	Shuttle Driver Cushion Spring Screw (2)..
1253AL	26103	Shuttle Driver Set Screw (2).....
125299	26105	Shuttle Race Back.....
125301	26105	Shuttle Race Back Position Pin (2).....
125302	26105	Shuttle Race Back Spring
51261R	26105	Shuttle Race Back Spring Thumb Screw...
125303	26105	Shuttle Race Body.....
125304	-----	Shuttle Race Body 125303 with 125305 and two 662R
125300	-----	Shuttle Race Body 125304 with 125290 and two each 391R and 125301.....
125305	26105	Shuttle Race Cap.....
662R	26105	Shuttle Race Cap Screw (2).....
125306	26105	Shuttle Race complete, Nos. 51261R, 125299, 125300 and 125302.....
145J	26105	Shuttle Race Screw (2).....
125337	26102	Shuttle Race Slide Spring
51282ZJ	26102	Shuttle Race Slide Spring Screw (2).....
125338BA	26102	Shuttle Race Slide with 125337 and two 51282ZJ
125475	26001	Stitch Indicator Plate
		NOTE: When ordering No. 125475, color required, must be specified.
335ZJ	26001	Stitch Indicator Plate Screw (2).....
125481	26001	Stitch Regulating Plate
125479	-----	Stitch Regulating Plate 125481 with 45310, 51312ZB, 125400 and 125475.....
		NOTE: When ordering No. 125479, color required, must be specified.
51312ZB	26001	Stitch Regulating Thumb Screw.....
45310	26001	Stitch Regulating Thumb Screw Washer (fiber).....
125400	26001	Stitch Regulating Thumb Screw Friction Washer
2102	26101	Tension Disc (2).....
125421AH	26101	Tension Indicator.....
		NOTE: When ordering No. 125421, color required, must be specified.
125416AH	26101	Tension Indicator Flange
		NOTE: When ordering No. 125416, color required, must be specified.

No.	Plate	Name
45865	26101	Tension Indicator Flange Stop Washer.....
51682ZB	26101	Tension Regulating Thumb Nut with 45339..
45339	26101	Tension Regulating Thumb Nut Engaging Pin.....
125417	26101	Tension Releasing Pin.....
125314	26101	Tension Spring.....
140175ZJ	26101	Tension Stud.....
125420	-----	Tension Stud 140175ZJ with 51682ZB.....
15410	26101	Tension Stud Bushing.....
50292ZB	26101	Tension Stud Set Screw.....
125418AH	26101	Tension (graduated) complete, Nos. 45865, 125314, 125316, 125416, 125417, 125419, 125420, 125421 and two 2102.....
		NOTE: When ordering No. 125418, color required, must be specified.
26075	26104	Thread Cutter and Holder.....
15272	26100	Thread Take-up Cam with 140511AL.....
15434	-----	Thread Take-up Cam 15272 with 570C and 1520R.....
140511AL	26100	Thread Take-up Cam Position Screw.....
*125382	26100	Thread Take-up Lever with 1822.....
125383	-----	Thread Take-up Lever 125382 with 50527C
50527C	26100	Thread Take-up Lever Hinge Screw.....
1822	26100	Thread Take-up Lever Roller and Stud, ...
125316	26101	Thread Take-up Spring.....
125317	26101	Thread Take-up Spring Regulator.....
857ZB	26101	Thread Take-up Spring Regulator Set Screw.....
125419	26101	Thread Take-up Spring Thread Guard and Tension Thread Guide.....
173585	26102	Throat Plate for 125261.....
		NOTE: When ordering No. 173585, state finish required.
691BB	26102	Throat Plate Screw (2).....
140543L	-----	Trade Mark Drive Screw (2).....

MACHINE NO. 15-126
For Use With School Sewing and Cutting Table
Sets Nos. 417, 418, and 419

THIS MACHINE IS THE SAME AS NO. 15-125 WITH THE
FOLLOWING EXCEPTIONS:

WIRING HARNESS NO. 197177

No.	Plate	Name
196692	26020	Bed Extension.....
		NOTE: When ordering No. 196692, color required, must be stated.
195163	26020	Bed Extension Grommet (rubber).....
		NOTE: When ordering No. 195163, color required, must be stated.
	160R	Bed Extension Screw (2).....
	90530	Bed Extension Screw Washer (2).....
197245	26020	Lead Cord.....
		NOTE: When ordering No. 197245, color required, must be stated.
197185	-----	Lead Cord with Three-Pin Terminal (female half) complete from Three-Pin Terminal to Safety Switch, Nos. 196763 and 197245.....
		NOTE: When ordering No. 197185, color required, must be stated.
197184	26020	Lead Cord with Six-Pin Plug complete, from Wiring Outfit to Safety Switch....
197181	26020	Lead Cord Clamp with wood screw.....
965105	26020	Lead Cord Connector (5).....
197183	26020	Lead Cord Strain Relief (2).....
196690	26020	Switch (Mercury).....
197207	26020	Switch Box.....
140766	26020	Switch Box Fastening Screw (2).....
196691	26020	Switch Clip (2).....
140703	26020	Switch Clip Fastening Screw (2).....
51746	26020	Switch Clip Fastening Screw Nut (2)....
197015	26020	Switch Insulation (2).....
198955	26020	Three-Pin Terminal (female half) Cord Hole Plug.....
		NOTE: When ordering No. 198955, color required, must be stated.
196769	26020	Three-Pin Terminal (female half) Ground Contact.....
140593	26020	Three-Pin Terminal (female half) Ground Contact Screw.....
196766	26020	Three-Pin Terminal (female half) Housing (lower).....
		NOTE: When ordering No. 196766, color required, must be stated.
196768	26020	Three-Pin Terminal (female half) Housing (upper).....
		NOTE: When ordering No. 196768, color required, must be stated.

No.	Plate	Name
50577	26020	Three-Pin Terminal (female half) Housing Screw (4).....
1768X	26020	Three-Pin Terminal (female half) Housing Screw Nut (4).....
196767	26020	Three-Pin Terminal (female half) Sleeve (3).....
140593	26020	Three-Pin Terminal (female half) Sleeve Screw (3).....
196763	26020	Three-Pin Terminal (female half) complete, Nos. 196766, 196768, 196769, 198955, three 196767 and four each 1768X, 50577 and 140593.....
		NOTE: When ordering No. 196763, color required, must be stated.
197177	26020	Wiring Harness complete, Nos. 195163, 196690, 196692, 197015, 197181, 197184, 197185, 197207, two each 160, 51746, 90530, 140703, 140766, 196691, 197183 and five 965105.....
		NOTE: When ordering No. 197177, color required, must be stated.

MOTOR PARTS

No.	Plate	Name
193555	-----	Armature complete for PJ2-3 Motor.....
193556	-----	Armature complete for PJ2-5 Motor.....
195881	-----	Armature complete for PJ2-6 Motor.....
193557	-----	Armature complete for PJ2-7 Motor.....
193558	-----	Armature complete for PJ2-8 Motor.....
193559	-----	Armature complete for PJ2-9 Motor.....
193560	-----	Armature complete for PJ2-10 Motor.....
193561	-----	Armature complete for PJ2-11 Motor.....
195882	-----	Armature complete for PJ2-12 Motor.....
196196	-----	Armature complete for PJ2-14 Motor.....
193562	-----	Armature complete for PJ2-15 Motor.....
447AL	26019	Armature Shaft Bearing Sleeve (commutator end) Set Screw.....
50617R	26019	Armature Shaft Bearing Sleeve (front end) Cap Screw.....
447AL	26019	Armature Shaft Bearing Sleeve (front end) Set Screw.....
193529	26019	Armature Shaft Pinion (spiral) with two 462AL.....
462AL	26019	Armature Shaft Pinion Set Screw.....
192457	26019	Brush (carbon) (2).....
193543	26019	Brush Cap (2).....
		NOTE: When ordering No. 193543, color required, must be stated.
196961	26019	Brush Spring (2).....
194113	26019	Brush Tube (2).....
193546	26019	Brush Tube Insulating Bushing (2).....
882AL	26019	Brush Tube Insulating Bushing Set Screw (2).....
193565	-----	Field Coil complete, for PJ2-3 Motor.....
		NOTE: When ordering No. 193565, color of lead must be stated.
193568	-----	Field Coil complete, for PJ2-5 Motor.....
		NOTE: When ordering No. 193568, color of lead must be stated.
193571	-----	Field Coil complete, for PJ2-6 Motor.....
		NOTE: When ordering No. 193571, color of lead must be stated.
193574	-----	Field Coil complete, for PJ2-7 Motor.....
		NOTE: When ordering No. 193574, color of lead must be stated.
193577	-----	Field Coil complete, for PJ2-8 Motor.....
		NOTE: When ordering No. 193577, color of lead must be stated.
193580	-----	Field Coil complete, for PJ2-9 Motor.....
		NOTE: When ordering No. 193580, color of lead must be stated.
195883	-----	Field Coil complete, for PJ2-10 Motor ...
		NOTE: When ordering No. 195883, color of lead must be stated.

No.	Plate	Name
193583	-----	Field Coil complete, for PJ2-11 Motor.... NOTE: When ordering No. 193583, color of lead must be stated.
193586	-----	Field Coil complete, for PJ2-12 Motor.... NOTE: When ordering No. 193586, color of lead must be stated.
196197	-----	Field Coil complete, for PJ2-14 Motor.... NOTE: When ordering No. 196197, color of lead must be stated.
193589	-----	Field Coil complete, for PJ2-15 Motor.... NOTE: When ordering No. 193589, color of lead must be stated.
727511	26019	Field Coil Lead Bushing (rubber)..... NOTE: When ordering No. 727511, color required, must be stated.
197149	26019	Field Coil Lead Strain Relief
197303	-----	Field Coil Retainer (2).....
193541	26019	Field Core Complete
51286R	26019	Field Core Screw (2).....
194097	26019	Grease Wick (2)
193525	-----	Grease Wick 194097 with 193527 (2).....
193527	26019	Grease Wick Spring (2).....
51284R	26019	Grease Wick Spring Cap Screw (2).....
193640	26019	Grease Wick Spring Retainer.....
192851	-----	Lead Cord complete, from lamp socket to three-pin terminal, for Knee Control ... NOTE: When ordering No. 192851, color required, must be stated.
193544	26019	Motor Cover
		NOTE: When ordering No. 193544, color required, must be stated.
224R	26019	Motor Cover Screw (2)
197459	26019	Motor Frame with two each 447AL and 882AL..... NOTE: When ordering No. 197459, color required, must be stated.
51285E	26019	Motor Frame Screw (2).....
193700	26019	Three-Pin Terminal Body (male half).... NOTE: When ordering No. 193700, color required, must be stated.
51582	26019	Three-Pin Terminal Body (male half) Post Thumb Nut (3)
		NOTE: When ordering No. 51582, color required, must be stated.
701719	26019	Three-Pin Terminal Body (male half) Post Washer (3)
192797	-----	Three-Pin Terminal Body (male half) complete, Nos. 193700 and three each 51582 and 701719
		NOTE: When ordering No. 192797, color required, must be stated.
194093	26019	Three-Pin Terminal Body (male half) Bracket
		NOTE: When ordering No. 194093, color required, must be stated.

No.	Plate	Name
51293E	26019	Three-Pin Terminal Body (male half) Bracket Screw.....
50657R	26019	Three-Pin Terminal Body (male half) Screw
190439	-----	Tube, filled with Singer Motor Lubricant..
190613	-----	Tube 190439 with 190612.....
190612	-----	Tube Carton (paper)

CONTROLLERS (Bakelite)
 CONVERTIBLE FOR FOOTOR KNEE CONTROL
 FOR NO. 15-125 MACHINE

No.	Plate	Name
194827	-----	Controller complete for 32 to 55 volts, A. C. or D. C. Motor, Nos. 194321, 194573, 194825, 196917 and four each 140099X and 194407..... NOTE: When ordering No. 194827, color required, must be specified.
194828	26012	Controller complete for 95 to 145 volts, A. C. or D. C. Motor, Nos. 194321, 194573, 194825, 196918 and four each 140099X and 194407..... NOTE: When ordering No. 194828, color required, must be specified.
194829	-----	Controller complete for 150 to 250 volts, A. C. or D. C. Motor, Nos. 194321, 194573, 194825, 196919 and four each 140099X and 194407..... NOTE: When ordering No. 194829, color required, must be specified.
196930	26012	Controller Base..... NOTE: When ordering No. 196930, color required, must be specified.
196917	-----	Controller Base 196930 with 196939 and two each 23258, 140103X and 931090.... NOTE: When ordering No. 196917, color required, must be specified.
196918	26012	Controller Base 196930 with 196940 and two each 23258, 140103X and 931090.... NOTE: When ordering No. 196918, color required, must be specified.
196919	-----	Controller Base 196930 with 196941 and two each 23258, 140103X and 931090.... NOTE: When ordering No. 196919, color required, must be specified.
194407	26012	Controller Base Cushion (rubber) (4).... NOTE: When ordering No. 194407, color required, must be specified.
140099X	26012	Controller Base Screw (4).....
194573	26012	Controller Cover..... NOTE: When ordering No. 194573, color required, must be specified.
194321	26012	Controller Foot Pedal..... NOTE: When ordering No. 194321, color required, must be specified.
194825	26012	Controller Lead complete, 60 in. long.... NOTE: When ordering No. 194825, color required, must be specified.
196953	-----	Controller Resistance Unit for 32 to 55 volts, A. C. or D. C.
196954	26012	Controller Resistance Unit for 95 to 145 volts, A. C. or D. C.
196955	-----	Controller Resistance Unit for 150 to 250 volts, A. C. or D. C.

No.	Plate	Name
196935	26012	Controller Resistance Unit Linkage.....
196937	26012	Controller Resistance Unit Linkage Cross Slide.....
1783X	26012	Controller Resistance Unit Linkage Cross Slide Nut.....
196939	-----	Controller Resistance Unit with Linkage, Nos. 1783X, 196935, 196937, 196953 and two each 50587J, 51327J and 193384, for 32 to 55 Volts, A. C. or D. C.
196940	-----	Controller Resistance Unit with Linkage, Nos. 1783X, 196935, 196937, 196954 and two each 50587J, 51327J and 193384, for 95 to 145 volts, A. C. or D. C.
196941	-----	Controller Resistance Unit with Linkage, Nos. 1783X, 196935, 196937, 196955 and two each 50587J, 51327J and 193384, for 150 to 250 volts, A. C. or D. C.
140103X	26012	Controller Resistance Unit Screw (2)....
931090	-----	Controller Resistance Unit Screw Washer (asbestos) (2).....
23258	26012	Controller Resistance Unit Screw Washer (steel) (2).....
193384	26012	Controller Resistance Unit Short Circuiting Contact (2).....
51327J	26012	Controller Resistance Unit Short Circuiting Contact Screw (2).....
50587J	26012	Controller Resistance Unit Terminal Screw (2).....

FOOT CONTROLLERS (Bakelite)
FOR NO. 15-125 MACHINE

No.	Plate	Name
194583	-----	Controller complete, for 32 to 55 volts, A. C. or D. C. Motor, Nos. 194321, 194573, 194574, 196917 and four each 140099X and 194407. NOTE: When ordering No. 194583, color required, must be specified.
194584	26013	Controller complete, for 95 to 145 volts, A. C. or D. C. Motor, Nos. 194321, 194573, 194574, 196918 and four each 140099X and 194407. NOTE: When ordering No. 194584, color required, must be specified.
194585	-----	Controller complete, for 150 to 250 volts, A. C. or D. C. Motor, Nos. 194321, 194573, 194574, 196919 and four each 140099X and 194407. NOTE: When ordering No. 194585, color required, must be specified.
196930	26013	Controller Base NOTE: When ordering No. 196930, color required, must be specified.
196917	-----	Controller Base 196930 with 196939 and two each 23258, 140103X and 931090. NOTE: When ordering No. 196917, color required, must be specified.
196918	26013	Controller Base 196930 with 196940 and two each 23258, 140103X and 931090. NOTE: When ordering No. 196918, color required, must be specified.
196919	-----	Controller Base 196930 with 196941 and two each 23258, 140103X and 931090. NOTE: When ordering No. 196919, color required, must be specified.
194407	26013	Controller Base Cushion (rubber) (4) NOTE: When ordering No. 194407, color required, must be specified.
140099X	26013	Controller Base Screw (4):....
194573	26013	Controller Cover NOTE: When ordering No. 194573, color required, must be specified.
194321	26013	Controller Foot Pedal. NOTE: When ordering No. 194321, color required, must be specified.
194575	26013	Controller Lead Cord from Controller to Three-pin Terminal NOTE: When ordering No. 194575, color required, must be specified.
194517	26013	Controller Lead Cord from Wall Socket to Three-pin Terminal NOTE: When ordering No. 194517, color required, must be specified.

No.	Plate	Name
194522	26013	Controller Lead Cord from Wall Socket to Three-pin Terminal complete, Nos. 194517 and 194518. NOTE: When ordering No. 194522, color required, must be specified.
194518	26013	Controller Lead Cord Plug NOTE: When ordering No. 194518, color required, must be specified.
194574	26013	Controller Lead Cord with Three-pin Terminal complete, Nos. 194521, 194522 and 194575. NOTE: When ordering No. 194574, color required, must be specified.
196953	-----	Controller Resistance Unit, for 32 to 55 volts, A. C. or D. C.
196954	26013	Controller Resistance Unit, for 95 to 145 volts, A. C. or D. C.
196955	-----	Controller Resistance Unit, for 150 to 250 volts, A. C. or D. C.
196935	26013	Controller Resistance Unit Linkage
196937	26013	Controller Resistance Unit Linkage Cross Slide
1783X	26013	Controller Resistance Unit Linkage Cross Slide Nut.
196939	-----	Controller Resistance Unit with Linkage, Nos. 1783X, 196935, 196937, 196953 and two each 50587J, 51327J and 193384, for 32 to 55 volts, A. C. or D. C.
196940	-----	Controller Resistance Unit with Linkage, Nos. 1783X, 196935, 196937, 196954 and two each 50587J, 51327J and 193384, for 95 to 145 volts, A. C. or D. C.
196941	-----	Controller Resistance Unit with Linkage, Nos. 1783X, 196935, 196937, 196955 and two each 50587J, 51327J and 193384, for 150 to 250 volts, A. C. or D. C.
140103X	26013	Controller Resistance Unit Screw (2)
931090	-----	Controller Resistance Unit Screw Washer (asbestos) (2).
23258	26013	Controller Resistance Unit Screw Washer (steel) (2).
193384	26013	Controller Resistance Unit Short Circuiting Contact (2)
51327J	26013	Controller Resistance Unit Short Circuiting Contact Screw (2)
50587J	26013	Controller Resistance Unit Terminal Screw (2)
192644	26013	Three-pin Terminal (female half) Housing (lower) NOTE: When ordering No. 192644, color required, must be specified.

No.	Plate	Name
194520	26013	Three-pin Terminal (female half) Housing (upper).....
		NOTE: When ordering No. 194520, color required, must be specified.
51093X	26013	Three-pin Terminal (female half) Housing Screw (2).....
1768X	26013	Three-pin Terminal (female half) Housing Screw Nut (2).....
192691	26013	Three-pin Terminal (female half) Housing Sleeve (3).....
192692	26013	Three-pin Terminal (female half) Housing Sleeve Clamp (3).....
194521	26013	Three-pin Terminal (female half) complete, Nos. 192644, 194520, two each 1768X, 51093X and three each 192691 and 192692.....
		NOTE: When ordering No. 194521, color required, must be specified.

LIGHT

No.	Plate	Name
195281	24626	Body (lower half).....
		NOTE: When ordering No. 195281, color required, must be specified.
195280	24626	Body (upper half).....
		NOTE: When ordering No. 195280, color required, must be specified.
195958	24626	Body (upper half) 195280 with 195143, 196240 and 931868.....
		NOTE: When ordering No. 195958, color required, must be specified.
195352	24626	Body Snap Ring (large) (2).....
195130	24626	Body Snap Ring (small).....
195353	26014	Bracket.....
		NOTE: When ordering No. 195353, color required, must be specified.
50027ALX or ALD	26014	Bracket Screw (to fasten to Machine).....
140738X or J	26014	Bracket Screw (to fasten to Light Body) (2)
195349	26014	Lead with Terminal Clips and Spring Contacts complete, Nos. 195141 and 195351.....
		NOTE: When ordering No. 195349, color required, must be specified.
195279	24626	Lens (Blue Glass).....
195357	24626	Reflector.....
195282	24626	Shade.....
		NOTE: When ordering No. 195282, color required, must be specified.
195358	24626	Shade Holder (2).....
		NOTE: When ordering No. 195358, color required, must be specified.
195351	24626	Spring Contact and Holder.....
195141	24626	Spring Contact (lead end).....
196240	24626	Switch Key.....
		NOTE: When ordering No. 196240, color required, must be specified.
195143	-----	Switch Key Snap Ring.....
931868	-----	Switch Key Spring Washer.....
195957	24626	Switch Rotating Contact with Cam and Insulation.....
195289	26014	Light (Blue Glass) complete (less lamp) Nos. 50027ALX or ALD, 195130, 195279, 195281, 195282, 195349, 195353, 195357, 195957, 195958, and two each 140738X or J, 195352 and 195358.....
		NOTE: When ordering No. 195289, color required, must be specified.

LIGHT LAMP

No.	Plate	Name
194120	-----	Light Lamp.....
NOTE: When ordering No. 194120, state voltage required. We are prepared to furnish the following voltages:		
		32
		50
		110 to 120
		200 to 220
		230 to 250

ACCESSORIES

No.		Name
2007ZG	26101	Arm Spool Pin.....
120855	26016	Hemmer (foot).....
125453	26105	Bobbin (4).....

BOBBIN WINDER

15072	26019	Bobbin Position Pin.....
66670	26019	Frame.....
NOTE: When ordering No. 66670, color required, must be specified.		
125366	26019	Frame 66670 with 15288 and 125068.....
NOTE: When ordering No. 125366, color required, must be specified.		
51319ZJ	26019	Frame Hinge Screw.....
66601	26019	Frame Spring.....
15287	26019	Friction Ring (rubber).....
NOTE: When ordering No. 15287, color required, must be specified.		
15288	26019	Pulley.....
125068	26019	Spindle with 15072.....
8879	26101	Spool Pin Washer (cloth).....
NOTE: When ordering No. 8879, color required, must be specified.		
125376	26019	Stop Latch.....
51303ZJ	26019	Stop Latch Hinge Screw.....
125462	26019	Stop Latch Spring.....
125395	26019	Tension Bracket.....
125396	26019	Tension Bracket complete, Nos. 45847, 45915, 45916, 125395 and 140138ZB.....
193ZB	26019	Tension Bracket Screw.....
45915	26019	Tension Disc.....
45916	26019	Tension Disc Screw Washer.....
45847	26019	Tension Disc Spring.....
140138ZB	26019	Tension Screw.....
125326	26019	Tripping Arm.....
190ZB	26019	Tripping Arm Screw.....

BIAS GAUGE

No.	Plate	Name
25525	-----	Bias Gauge.....

BRAIDER

No.		Name
25510	26016	Braider.....
289B	26016	Braider Thumb Screw.....

FELLER (Foot)

No.		Name
120914	26016	Feller (foot).....

FINGER GUARD

No.		Name
121725	26017	Finger Guard.....

HEMMER (Foot)

No.		Name
120962	26016	Hemmer (foot) for 1/8 in. hem.....
25893	26016	Hemmer (foot) for 1/4 in. hem.....

HEMSTITCHER

No.		Name
120687	26016	Hemstitcher with Yielding Presser Plate..

PRESSER FEET

No.		Name
36058	26016	Presser Foot with 665B and 36059, for blind stitch cording, to turn small curves.....
36059	26016	Presser Foot Cord Guide.....
NOTE: When ordering No. 36058 or 36059, send sample of cord, for which it is to be used..		
665B	26016	Presser Foot Cord Guide Screw.....
36067	26016	Presser Foot, for braiding, for art work, for braid 1/16 in. to 3/16 in. wide.....
NOTE: When ordering No. 36067, state the size or send sample of braid for which it is to be used.		
25978	26016	Presser Foot (single toe) for gathering...

**PRESSER FOOT WITH GRADUATED
ADJUSTABLE GUIDES**

No.	Plate	Name
121717	26017	Presser Foot with 337D, 35002, 35135, 35206 and 36696.....
35002	26017	Presser Foot Extension.....
35003	26017	Presser Foot Graduated Adjustable Guide (long, left).....
35004	26017	Presser Foot Graduated Adjustable Guide (long, right).....
35005	26017	Presser Foot Graduated Adjustable Guide (short, right).....
35006	26017	Presser Foot Graduated Adjustable Guide (short, right) flush.....
35135	26017	Presser Foot Graduated Adjustable Guide Clamp.....
35206	26017	Presser Foot Graduated Adjustable Guide Clamp Lever.....
337D	26017	Presser Foot Graduated Adjustable Guide Clamp Screw.....
36696	26017	Presser Foot Graduated Adjustable Guide Clamp Steady Pin.....
121718	26017	Presser Foot with Extension and Graduated Adjustable Guide complete, Nos. 35003, 35004, 35005, 35006 and 121717.....

QUILTER

No.	Name
35932	26017 Quilter.....

**RUFFLER SHIRRING PLATE
(Universal)**

121170	26017	Ruffler Shirring Plate (universal) with 51395W.....
51395W	26017	Ruffler Shirring Plate Thumb Screw.....

SEAM GUIDE

No.	Name	
25527	26017	Seam Guide.....
50053ZB	26017	Seam Guide Thumb Screw.....

STILETTO

No.	Name	
25539	-----	Stiletto.....

UNDER BRAIDER

No.	Plate	Name
160927	26017	Under Braider with 51395W.....
51395W	26017	Under Braider Thumb Screw.....

**SET OF ATTACHMENTS NO. 160809
(U.S.A. and Canada only - with needles)**

No.	Name	
160359	26015	Binder.....
36865	26015	Edge Stitcher.....
121441	26015	Gathering Foot (double toe).....
35931	26015	Hemmer (adjustable).....
15x1	-----	Needles (3 each sizes 11 and 14) (6).....
120598	26015	Ruffler.....
25537	26015	Screw Driver (machine).....
120378	26015	Screw Driver (Shuttle Tension).....
161133	26015	Tube of Oil.....
160809	26015	Set of Attachments (with needles) complete, Nos. 25537, 35931, 36865, 120378, 120598, 121441, 160359, 161133, two 8879 and six needles (15x1, three each sizes 11 and 14).....

**SET OF ATTACHMENTS NO. 160810
(All Countries except U.S.A., Canada and Brazil with needles)**

No.	Name	
121464	26015	Binder.....
36865	26015	Edge Stitcher.....
121441	26015	Gathering Foot (double toe).....
35931	26015	Hemmer (adjustable).....
15x1	-----	Needles (3 each sizes 11 and 14) (6).....
120598	26015	Ruffler.....
25537	26015	Screw Driver (machine).....
120378	26015	Screw Driver (Shuttle Tension).....
160810	-----	Set of Attachments (with needles) complete, Nos. 25537, 35931, 36865, 120378, 120598, 121441, 121464, two 8879 and six needles (15x1, three each of sizes 11 and 14).....

SET OF ATTACHMENTS NO. 160811
(Brazil only - less needles)

No.	Plate	Name
121464	26015	Binder.....
36865	26015	Edge Stitcher.....
121441	26015	Gathering Foot (double toe).....
35931	26015	Hemmer (adjustable).....
120598	26015	Ruffler.....
25537	26015	Screw Driver (machine).....
120378	26015	Screw Driver (Shuttle Tension).....
160811	----	Set of Attachments (less needles) complete, Nos. 25537, 35931, 36865, 120598, 120378, 121441, 121464 and two 8879

SPECIAL ATTACHMENTS

No.	Name
161102	---- Automatic Zigzagger Attachment.....
160506	---- Buttonholer.....
35505	---- Embroidery Attachment for two threads.....
26538	---- Style-o-matic Attachment.....
121634	---- Needle Threader and Seam Ripper.....
35985	---- Tubular Trimming Attachment.....
160858	---- Darning Attachment (stripper foot).....
160719	---- Darning and Embroidery Attachment.....
160741	---- Walking Presser Foot.....
161127	---- Zipper Foot (left or right) adjustable, hinged.....

NUMERICAL LIST OF PARTS

No.	Name
138E 26100	Arm Screw for 171532.....
145J 26105	Shuttle Race Screw.....
157R 26103	Feed Lifting Rock Shaft Crank Clamping Screw for 125388.....
160R 26020	Bed Extension Screw for 197177.....
175R 26100	Feed Forked Connection Adjusting Screw for 125262.....
190ZB 26019	Bobbin Winder Tripping Arm Screw.....
193ZB 26019	Bobbin Winder Tension Bracket Screw.....
208AL 26102	Feed Dog Screw.....
224R 26019	Motor Cover Screw.....
246ZA 26100	Clamp Stop Motion Clamp Stop Screw.....
289B 26016	Braider Thumb Screw.....
304C 26103	Feed Lifting Rock Shaft Screw Center for 125344.....
304C 26103	Feed Rock Shaft Screw Center for 125344.....
315C 26103	Feed Bar Screw Center for 15445.....
335ZJ 26001	Stitch Indicator Plate Screw.....
337D 26017	Presser Foot Graduated Adjustable Guide Clamp Screw for 121717.....
375C 26100	Crank Connecting Rod Hinge Screw.....
391R 26105	Shuttle Bobbin Case Position Plate Screw for 125300.....
435AL 26100	Arm Shaft Bushing Set Screw.....
447AL 26019	Armature Shaft Bearing Sleeve (commutator end) Set Screw for 197459.....
447AL 26019	Armature Shaft Bearing Sleeve (front end) Set Screw for 197459.....
453AL 26104	Presser Bar Spring Bracket Set Screw for 2068.....
462AL 26019	Armature Shaft Pinion Set Screw for 193529
462AL 26100	Clamp Stop Motion Flanged Bushing Set Screw for 125372.....
462AL 26103	Oscillating Shaft Crank Set Screw for 125284.....
570C 26100	Needle Bar Connecting Link Hinge Screw for 15434.....
591F 26105	Shuttle Tension Regulating Screw for 125291.....
592E 26105	Shuttle Bobbin Case Latch Stop Screw for 125291.....
662R 26105	Shuttle Race Cap Screw for 125304.....
665B 26016	Presser Foot Cord Guide Screw for 36058..
691BB 26102	Throat Plate Screw.....
857ZB 26101	Thread Take-up Spring Regulator Set Screw for 125483.....
882AL 26019	Brush Tube Insulating Bushing Set Screw for 197459.....
896AL 26100	Crank Connecting Rod Cap Screw for 125021
1085E 26100	Feed Forked Connection Slide Block Screw Stud for 125335.....
1253AL 26103	Shuttle Driver Set Screw for 125297.....

No.	Plate	Name
1285AL	26100	Feed Cam and Counterbalance Position Screw for 125045.....
1341AL	26104	Needle Bar Connecting Stud Set Screw for 125276
1498AL	26104	Needle Bar Bushing Set Screw.....
1513R	26103	Feed Lifting Rock Shaft Screw Center Nut for 125344
1513R	26103	Feed Rock Shaft Screw Center Nut for 125344
1518R	26100	Crank Connecting Rod Hinge Screw Nut....
1519R	26103	Feed Bar Screw Center Nut for 15445
1520R	26100	Feed Forked Connection Hinge Screw Nut..
1520R	26100	Needle Bar Connecting Link Hinge Screw Nut for 15434.....
1550R	26001	Feed Reversing Handle Lock Nut for 125381
1768X	26013	Three-Pin Terminal (female half) Housing Screw Nut, for 194521 and 196763.....
1783X	26012	Controller Resistance Unit Linkage Cross Slide Nut for 196939, 196940 and 196941.
1813	-----	Feed Bar Throw-out Lever Roller and Stud Nos. 1904 and 125060, for 125386.....
1822	26100	Thread Take-up Lever Roller and Stud for 125382.....
1904	26103	Feed Bar Throw-out Lever Roller for 1813
2002	26100	Arm Dowel Pin for 171532
2007ZG	26101	Arm Spool Pin.....
2007ZG	26101	Bobbin Winder Spool Pin.....
2068	26104	Presser Bar Spring Bracket with 453AL...
2070	26104	Presser Bar Spring Washer.....
2102	26101	Tension Disc for 125418
2835	26103	Feed Bar
2974	26105	Shuttle Bobbin Case Latch Lever Fulcrum Pin for 125288.....
2975	26105	Shuttle Bobbin Case Latch Spring for 125291
8879	26101	Arm Spool Pin Washer (cloth) for 160809, 160810 and 160811
		NOTE: When ordering No. 8879, color required, must be specified.
8879	26101	Bobbin Winder Spool Pin Washer (cloth) for 160809, 160810 and 160811.....
		NOTE: When ordering No. 8879, color required, must be specified.
15072	26019	Bobbin Winder Bobbin Position Pin for 125068.....
15248	26104	Needle Bar Connecting Link with 51002E, for 125275.....
15272	26100	Thread Take-up Cam with 140511AL, for 15434.....
15287	26019	Bobbin Winder Friction Ring (rubber)....
		NOTE: When ordering No. 15287, color required, must be specified.
15288	26019	Bobbin Winder Pulley for 125366.....
15410	26101	Tension Stud Bushing for 125482.....

No.	Plate	Name
15434	-----	Thread Take-up Cam 15272 with 570C and 1520R, for 125254.....
15445	-----	Feed Bar Screw Center 315C with 1519R...
15486	26104	Presser Bar Lifter Hinge Stud.....
15498	26100	Arm Shaft Bushing, for 125254 and 171531.
23258	26012	Controller Resistance Unit Screw Washer (steel) for 196917, 196918 and 196919...
25510	26016	Braider.....
25525	-----	Bias Gauge.....
25527	26017	Seam Guide.....
25537	26015	Screw Driver (Machine) for 160809, 160810 and 160811
25539	-----	Stiletto
25893	26016	Hemmer (foot) for 1/4 in. hem.....
25978	26016	Presser Foot (single toe) for gathering....
26075	26104	Thread Cutter and Holder.....
26538	-----	Style-o-matic Attachment (Special Attachments).....
35002	26017	Presser Foot Extension for 121717.....
35003	26017	Presser Foot Graduated Adjustable Guide (long, left) for 121718.....
35004	26017	Presser Foot Graduated Adjustable Guide (long, right) for 121718.....
35005	26017	Presser Foot Graduated Adjustable Guide (short, right) for 121718.....
35006	26017	Presser Foot Graduated Adjustable Guide (short, right) flush for 121718.....
35135	26017	Presser Foot Graduated Adjustable Guide Clamp for 121717
35206	26017	Presser Foot Graduated Adjustable Guide Clamp Lever for 121717
35505	-----	Embroidery Attachment for two threads (Special Attachments)
35931	26015	Hemmer (adjustable) for 160809, 160810 and 160811
35932	26017	Quilter
35985	-----	Tubular Trimming Attachment (Special Attachments).....
36058	26016	Presser Foot with 665B and 36059, for blind stitch cording, to turn small curves
		NOTE: When ordering No. 36058 send sample of cord for which it is to be used.
36059	26016	Presser Foot Cord Guide for 36058
		NOTE: When ordering No. 36059, send sample of cord, for which it is to be used.
36067	26016	Presser Foot, for braiding, for art work, for braid 1/16 in. to 3/16 in. wide.
		NOTE: When ordering No. 36067, state the size or send sample of braid for which it is to be used.
36696	26017	Presser Foot Graduated Adjustable Guide Clamp Steady Pin for 121717.....
36865	26015	Edge Stitcher for 160809, 160810 and 160811

No.	Plate	Name
45285	-----	Needle Clamp Body 45334 with 51308ZJ....
45305	26001	Feed Reversing Handle for 125381
45310	26001	Stitch Regulating Thumb Screw Washer (fiber) for 125479
45321	26102	Presser Foot (hinged)
45334	26104	Needle Clamp Body with 140545ZC, for 45285
45339	26101	Tension Regulating Thumb Nut Engaging Pin for 51682
45847	26019	Bobbin Winder Tension Disc Spring for 125396
45865	26101	Tension Indicator Flange Stop Washer for 125418
45915	26019	Bobbin Winder Tension Disc for 125396....
45916	26019	Bobbin Winder Tension Disc Screw Washer for 125396
50027ALX	26014	Light Bracket Screw (to fasten to machine) or ALD for 195289
50053ZB	26017	Seam Guide Thumb Screw
50292ZB	26101	Tension Stud Set Screw for 125483
50353E	26100	Feed Regulator Hinge Screw
50527C	26100	Thread Take-up Lever Hinge Screw for 125383
50577	26020	Three-Pin Terminal (female half) Housing Screw, for 196763
50587	26012	Controller Resistance Unit Terminal Screw for 196939, 196940 and 196941
50617R	26019	Armature Shaft Bearing Sleeve (front end) Cap Screw
50657R	26019	Three-Pin Terminal Body (male half) Screw
51002E	26104	Needle Bar Connecting Link Adjusting Screw, for 15248
51045AL	26100	Machine Hinge Connection Set Screw
51093X	26013	Three-Pin Terminal (female half) Housing Screw, for 194521
51224ZB	26102	Arm Side Cover Thumb Screw
51224ZB	26101	Face Plate Screw (lower)
51224ZB	26003	Presser Foot Thumb Screw
51228ZJ	26104	Pressure Regulating Thumb Screw for 66773
51229E	26103	Shuttle Driver Cushion Spring Screw for 125322
51246AL	26103	Oscillating Rock Shaft Center (left) Set Screw
51246AL	26103	Oscillating Rock Shaft Center (right) Set Screw
51252C	26100	Feed Forked Connection Hinge Screw (eccentric)
51261R	26105	Shuttle Race Back Spring Thumb Screw for 125306
51280ZB	26100	Clamp Stop Motion Clamp Screw
51282ZJ	26102	Shuttle Race Slide Spring Screw for 125338.
51284R	26019	Grease Wick Spring Cap Screw
51285E	26019	Motor Frame Screw

No.	Plate	Name
51286R	26019	Field Core Screw
51289X	26103	Feed Bar Throw-out Lever Thumb Screw for 125389
51293E	26019	Three-Pin Terminal Body (male half) Bracket Screw
51303ZJ	26019	Bobbin Winder Stop Latch Hinge Screw....
51308ZJ	26104	Needle Clamp Position Screw for 45285....
51312ZB	26001	Stitch Regulating Thumb Screw for 125479..
51319ZJ	26019	Bobbin Winder Frame Hinge Screw
51327J	26012	Controller Resistance Unit Short Circuiting Contact Screw for 196939, 196940 and 196941
51354J	26101	Face Plate Screw (upper)
51395W	26017	Ruffler Shirring Plate Thumb Screw for 121170
51395W	26017	Under Braider Thumb Screw for 160927....
51582	26019	Three-Pin Terminal Body (male half) Post Thumb Nut for 192797
		NOTE: When ordering No. 51582, color required, must be specified.
51682ZB	26101	Tension Regulating Thumb Nut with 45339, for 125420
51746	26020	Switch Clip Fastening Screw Nut, for 197177
66601	26019	Bobbin Winder Frame Spring
66670	26019	Bobbin Winder Frame for 125366
		NOTE: When ordering No. 66670, color required, must be specified.
66752	26104	Pressure Regulating Thumb Screw Plug (felt wick) for 66773
66773	-----	Pressure Regulating Thumb Screw 51228ZJ with 66752
80011	26104	Presser Bar Spring
81110	26100	Arm Oil Pad Spring for 171531
90530	26020	Bed Extension Screw Washer for 197177 ...
120378	26015	Screw Driver (Shuttle Tension) for 160809, 160810 and 160811
120598	26015	Ruffler for 160809, 160810 and 160811....
120687	26016	Hemstitcher with Yielding Presser Plate ..
120855	26016	Hemmer (foot) Accessories
120914	26016	Feller (foot)
120962	26016	Hemmer (foot) for 1/8 in. hem
121170	26017	Ruffler Shirring Plate (universal) with 51395W
121441	26015	Gathering Foot (double toe) for 160809, 160810 and 160811
121464	26015	Binder for 160810 and 160811
121634	-----	Needle Threader and Seam Ripper (Special Attachments)
121717	26017	Presser Foot with 337D, 35002, 35135, 35206 and 36696, for 121718
121718	26017	Presser Foot with Extension and Graduated Adjustable Guide complete, Nos. 35003, 35004, 35005, 35006 and 121717

No.	Plate	Name
121725	26017	Finger Guard.....
125021	26100	Crank Connecting Rod with 125044 and two 896AL.....
125044	26100	Crank Connecting Rod Oil Pad (felt) for 125021.....
125045	26100	Feed Cam and Counterbalance with 1285AL, for 125254.....
125047	26100	Feed Forked Connection Slide Block for 125335.....
125048	26103	Oscillating Rock Shaft Center (left).....
125049	26103	Oscillating Rock Shaft Center (right).....
125056	26103	Oscillating Rock Shaft Oil Wick (braided cotton) for 125280.....
125060	----	Feed Bar Throw-out Lever Roller Stud for 1813.....
125061	26104	Presser Bar.....
125068	26019	Bobbin Winder Spindle with 15072, for 125366.....
125253	26100	Arm Shaft for 125254.....
125254	----	Arm Shaft 125253 with 15434, 15498 and 125045.....
*125255	----	Bed for 171532.....
125261	26102	Feed Dog, 12 teeth (14 teeth to the inch) for 173585.....
125262	26100	Feed Forked Connection with 175R, for 125340.....
125263	26103	Feed Lifting Rock Shaft for 125390.....
125270U	26103	Feed Rock Shaft.....
125273	26104	Needle Bar Bushing with 125274.....
125274	26104	Needle Bar Bushing Oil Pad (felt) for 125273.....
125275	----	Needle Bar Connecting Link 15248 with 125276.....
125276	26104	Needle Bar Connecting Stud with 1341AL, for 125275.....
125280	26103	Oscillating Rock Shaft with 125056.....
125284	26103	Oscillating Shaft Crank with 125330 and two 462AL.....
125287	26105	Shuttle Bobbin Case Latch for 125288.....
125288	26105	Shuttle Bobbin Case Hinge, Nos. 2974, 125287 and 125320, for 125291.....
125290	26105	Shuttle Bobbin Case Position Plate for 125300.....
125291	26105	Shuttle Bobbin Case complete, for 125294, Nos. 591F, 592E, 2975, 125288 and 125293.....
125292	26105	Shuttle Body for 125294.....
125293	26105	Shuttle Tension Spring for 125291.....
125294	26105	Shuttle 1 11/16 in. diam., Nos. 125291, 125292 and 125453.....
125297	26103	Shuttle Driver with two 1253AL, for 125322.....
125298	26103	Shuttle Driver Cushion Spring for 125322..
125299	26105	Shuttle Race Back for 125306.....
125300	----	Shuttle Race Body 125304 with 125290 and two each 391R and 125301, for 125306...

No.	Plate	Name
125301	26105	Shuttle Race Back Position Pin for 125300.
125302	26105	Shuttle Race Back Spring for 125306.....
125303	26105	Shuttle Race Body for 125304.....
125304	----	Shuttle Race Body 125303 with 125305 and two 662R, for 125300.....
125305	26105	Shuttle Race Cap for 125304.....
125306	26105	Shuttle Race complete, Nos. 51261R, 125299, 125300 and 125302.....
125314	26101	Tension Spring for 125418.....
125316	26101	Thread Take-up Spring for 125418.....
125317	26101	Thread Take-up Spring Regulator for 125483.....
125320	26105	Shuttle Bobbin Case Latch Lever for 125288.....
125322	----	Shuttle Driver 125297 with 125298 and two 51229E.....
125326	26019	Bobbin Winder Tripping Arm.....
125330	26103	Oscillating Shaft Crank Slide Block for 125284.....
125331	26100	Arm Oil Pad (felt) for oiling Arm Shaft Back Bearing for 171531.....
125334	26100	Arm Oil Pad Spring Cap for 171531.....
125335	----	Feed Forked Connection Slide Block 125047 with 1085E, for 125340.....
125337	26102	Shuttle Race Slide Spring for 125338.....
125338BA	26102	Shuttle Race Slide with 125337 and two 51282ZJ.....
125340	----	Feed Forked Connection 125262 with 125335.....
125344	----	Feed Lifting Rock Shaft Screw Center 304C with 1513R.....
125344	----	Feed Rock Shaft Screw Center 304C with 1513R.....
125349	26103	Feed Bar Throw-out Lever Retaining Ring for 125390.....
125354	26100	Hand Wheel Gear Spring for 125459.....
125358	26100	Hand Wheel Spring Stud for 125459.....
125360	----	Clamp Stop Motion Flanged Bushing for 125372.....
125366	26019	Bobbin Winder Frame 66670 with 15288 and 125068.....
		NOTE: When ordering No. 125366, color required, must be specified.
125372	26100	Clamp Stop Motion Flanged Bushing 125360 with two 462AL.....
125373	----	Face Plate Thread Guard Rivet for 125472
125376	26019	Bobbin Winder Stop Latch.....
125377	26104	Needle Bar.....
125378	26104	Needle Clamp Gib and Thread Guard.....
125381	----	Feed Reversing Handle 45305 with 1550R, for 125398.....
*125382	26100	Thread Take-up Lever with 1822, for 125383.....
125383	----	Thread Take-up Lever 125382 with 50527C
125385	26100	Hand Wheel Gear Spring Cushion Pin (eccentric) for 125459.....

No.	Plate	Name
125386	26103	Feed Bar Throw-out Lever with 1813, for 125389.....
125387	-----	Feed Bar Throw-out Lever Spring for 125389.....
125388	26103	Feed Lifting Rock Shaft Crank with 157R, for 125389.....
125389	-----	Feed Lifting Rock Shaft Crank complete, for 12390, Nos. 51289X, 125386, 125387 and 125388.....
125390	-----	Feed Lifting Rock Shaft complete, Nos. 125263, 125349 and 125389.....
125395	26019	Bobbin Winder Tension Bracket for 125396
125396	26019	Bobbin Winder Tension Bracket complete, Nos. 45847, 45915, 45916, 125395 and 140138ZB.....
125397	26100	Feed Regulator for 125398.....
125398	-----	Feed Regulator 125397 with 125381.....
125399	26100	Feed Regulator Hinge Screw Friction Washer.....
125400	26001	Stitch Regulating Thumb Screw Friction Washer for 125479.....
125416AH	26101	Tension Indicator Flange for 125418.....
		NOTE: When ordering No. 125416, color required, must be specified.
125417	26101	Tension Releasing Pin for 125418.....
125418AH	26101	Tension (graduated) complete for 125484, Nos. 45865, 125314, 125316, 125416, 125417, 125419, 125420, 125421 and two 2102.....
		NOTE: When ordering No. 125418, color required, must be specified.
125419	26101	Thread Take-up Spring Thread Guard and Tension Thread Guide for 125418.....
125420	-----	Tension Stud 140175ZJ with 51682ZB, for 125418.....
125421AH	26101	Tension Indicator for 125418.....
		NOTE: When ordering No. 125421, color required, must be specified.
125453	26105	Shuttle Bobbin for 125294.....
125458	26100	Hand Wheel for 125459.....
		NOTE: When ordering No. 125458, color required, must be specified.
125459	-----	Hand Wheel 125458 with 125354, 125358, 125460, 125461 and two 125385.....
		NOTE: When ordering No. 125459, color required, must be specified.
125460	26100	Hand Wheel Gear for 125459.....
125461	26100	Hand Wheel Gear Retainer for 125459.....
125462	26019	Bobbin Winder Stop Latch Spring.....
125466	26001	Arm Side Cover.....
		NOTE: When ordering No. 125466, color required, must be specified.
125470	-----	Face Plate Thread Guard for 125472.....
125472	26101	Face Plate Thread Guard 125470 with 125373, for 125482.....

No.	Plate	Name
125474	26104	Presser Bar Lifter.....
125475	26001	Stitch Indicator Plate for 125479.....
		NOTE: When ordering No. 125475, color required, must be specified.
125479	-----	Stitch Regulating Plate, 125481 with 45310, 51312ZB, 125400 and 125475.....
		NOTE: When ordering No. 125479, color required, must be specified.
125481	26001	Stitch Regulating Plate for 125479.....
125482	26101	Face Plate with 15410 and 125472 for 125483.....
		NOTE: When ordering No. 125482, color required, must be specified.
125483	26101	Face Plate 125482 with 857ZB, 50292ZB and 125317, for 125484.....
		NOTE: When ordering No. 125483, color required, must be specified.
125484	26101	Face Plate complete, Nos. 125418 and 125483.....
		NOTE: When ordering No. 125484, color required, must be specified.
125500	26103	Oscillating Shaft.....
140099X	26012	Controller Base Screw for 194827, 194828, 194829, 194583, 194584 and 194585.....
140103X	26012	Controller Resistance Unit Screw for 196917, 196918 and 196919.....
140138ZB	26019	Bobbin Winder Tension Screw for 125396..
140175ZJ	26101	Tension Stud for 125420.....
140511AL	26100	Thread Take-up Cam Position Screw for 15272.....
140543L	-----	Number Plate Drive Screw for 171531....
140543L	-----	Trade Mark Drive Screw for 171531.....
140545ZC	26104	Needle Clamp Thumb Screw for 45334....
140593	26020	Three-Pin Terminal (female half) Ground Contact Screw, for 196763.....
140703	26020	Switch Clip Fastening Screw, for 197177..
140712AL	26104	Presser Bar Lifter Hinge Stud Set Screw..
140738X	26014	Light Bracket Screw (to fasten to Light Body) for 195289.....
140766	26020	Switch Box Fastening Screw, for 197177..
160359	26015	Binder for 160809.....
160506	-----	Buttonholer (Special Attachment).....
160719	-----	Darning and Embroidery Attachment (Special Attachments).....
160741	-----	Walking Presser Foot (Special Attachments).....
160809	26015	Set of Attachments (with needles) complete, for U.S.A. and Canada only with Needles, Nos. 25537, 35931, 36865, 120378, 120598, 121441, 160359, 161133, two 8879 and six needles (15x1, three each sizes 11 and 14).....

No.	Plate	Name
160810	-----	Set of Attachments (with needles) complete, (all countries except U.S.A., Canada and Brazil with needles) Nos. 25537, 35931, 36865, 120378, 120598, 121441, 121464, two 8879 and six needles)15x1, three each of sizes 11 and 14).....
160811	-----	Set of Attachments (less needles) complete, (Brazil only less needles) Nos. 25537, 35931, 36865, 120378, 120598, 121441, 121464 and two 8879 (15x1, three each of sizes 11 and 14)
160858	-----	Darning Attachment (stripper foot) (Special Attachments).....
160927	26017	Under Braider with 51395W.....
161102	-----	Automatic Zigzagger Attachment (Special Attachment)
161127	-----	Zipper Foot (left or right) adjustable, hinged (Special Attachments)
161133	26015	Tube of Oil for 160809
171505J	26100	Clamp Stop Motion Clamp Washer.....
171531	-----	Arm with 435AL, 15498, 81110, 125331, 125334, Trade Mark, Number Plate and four 140543L, for 171532.....
		NOTE: When ordering No. 171531, color required, must be specified.
171532	-----	Arm and Bed Nos. 125255, 171531, two 2002 and three 138E
		NOTE: When ordering No. 171532, color required, must be specified.
173585	26102	Throat Plate for 125261
		NOTE: When ordering No. 173585, state finish required.
190439	-----	Tube, filled with Singer Motor Lubricant, for 190613.....
190612	-----	Tube Carton (paper) for 190613.....
190613	-----	Tube 190439 with 190612
192457	26019	Brush (carbon)
192644	26013	Three-Pin Terminal (female half) Housing (lower) for 194521.....
		NOTE: When ordering No. 192644, color required, must be specified.
192691	26013	Three-Pin Terminal (female half) Housing Sleeve, for 194521.....
192692	26013	Three-Pin Terminal (female half) Housing Sleeve Clamp, for 194521
192797	-----	Three-Pin Terminal Body (male half) complete Nos. 193700 and three each 51582 and 701719
		NOTE: When ordering No. 192797, color required, must be specified.

No.	Plate	Name
192851	-----	Lead Cord complete, from Lamp Socket to Three-Pin Terminal, for Knee Control.....
		NOTE: When ordering No. 192851, color required, must be specified.
193384	26012	Controller Resistance Unit Short Circuiting Contact for 196939, 196940 and 196941
193525	-----	Grease Wick 194097 with 193527
193527	26019	Grease Wick Spring for 193525.....
193529	26019	Armature Shaft Pinion (spiral) with two 462AL
193541	26019	Field Core complete.....
193543	26019	Brush Cap.....
		NOTE: When ordering No. 193543, color required, must be specified.
193544	26019	Motor Cover.....
		NOTE: When ordering No. 193544, color required, must be specified.
193546	26019	Brush Tube Insulating Bushing.....
193555	-----	Armature complete for PJ2-3 Motor.....
193556	-----	Armature complete for PJ2-5 Motor.....
193557	-----	Armature complete for PJ2-7 Motor.....
193558	-----	Armature complete for PJ2-8 Motor.....
193559	-----	Armature complete for PJ2-9 Motor.....
193560	-----	Armature complete for PJ2-10 Motor.....
193561	-----	Armature complete for PJ2-11 Motor.....
193562	-----	Armature complete for PJ2-15 Motor.....
193565	-----	Field Coil complete for PJ2-3 Motor.....
		NOTE: When ordering No. 193565, color of lead must be specified.
193568	-----	Field Coil complete, for PJ2-5 Motor.....
		NOTE: When ordering No. 193568, color of lead must be specified.
193571	-----	Field Coil complete, for PJ2-6 Motor.....
		NOTE: When ordering No. 193571, color of lead must be specified.
193574	-----	Field Coil complete, for PJ2-7 Motor.....
		NOTE: When ordering No. 193574, color of lead must be specified.
193577	-----	Field Coil complete, for PJ2-8 Motor.....
		NOTE: When ordering No. 193577, color of lead must be specified.
193580	-----	Field Coil complete, for PJ2-9 Motor.....
		NOTE: When ordering No. 193580, color of lead must be specified.
193583	-----	Field Coil complete, for PJ2-11 Motor....
		NOTE: When ordering No. 193583, color of lead must be specified.
193586	-----	Field Coil complete, for PJ2-12 Motor....
		NOTE: When ordering No. 193586, color of lead must be specified.
193589	-----	Field Coil complete, for PJ2-15 Motor....
		NOTE: When ordering No. 193589, color of lead must be specified.

No.	Plate	Name
193640	26019	Grease Wick Spring Retainer.....
193700	26019	Three-Pin Terminal Body (male half) for 192797.....
		NOTE: When ordering No. 193700, color required, must be specified.
194093	26019	Three-Pin Terminal Body (male half) Bracket
		NOTE: When ordering No. 194093, color required, must be specified.
194097	26019	Grease Wick for 193525
194113	26019	Brush Tube
194120	-----	Light Lamp
		NOTE: When ordering No. 194120, state voltage required.
194321	26012	Controller Foot Pedal for 194827, 194828, 194829, 194583, 194584 and 194585.....
		NOTE: When ordering No. 194321, color required, must be specified.
194407	26012	Controller Base Cushion (rubber) for 194827, 194828, 194829, 194583, 194584 and 194585.....
		NOTE: When ordering No. 194407, color required, must be specified.
194517	26013	Controller Lead Cord from Wall Socket to Three-Pin Terminal for 194522.....
		NOTE: When ordering No. 194517, color required, must be specified.
194518	26013	Controller Lead Cord Plug for 194522.....
		NOTE: When ordering No. 194518, color required, must be specified.
194520	26013	Three-Pin Terminal (female half) Housing (upper) for 194521.....
		NOTE: When ordering No. 194520, color required, must be specified.
194521	26013	Three-Pin Terminal (female half) complete for 194574 Nos. 192644, 194520, two each 1768X, 51093X and three each 192691 and 192692
		NOTE: When ordering No. 194521, color required, must be specified.
194522	26013	Controller Lead Cord from Wall Socket to Three-Pin Terminal complete for 194574, Nos. 194517 and 194518.....
		NOTE: When ordering No. 194522, color required, must be specified.
194573	26012	Controller Cover for 194827, 194828, 194829, 194583, 194584 and 194585
		NOTE: When ordering No. 194573, color required, must be specified.
194574	26013	Controller Lead Cord with Three-Pin Terminal complete, for 194583, 194584 and 194585, Nos. 194521, 194522 and 194575
		NOTE: When ordering No. 194574 color required, must be specified.

No.	Plate	Name
194575	26013	Controller Lead Cord from Controller to Three-Pin Terminal for 194574.....
		NOTE: When ordering No. 194575, color required, must be specified.
194583	-----	Controller (foot) complete, for 32 to 55 volts, A. C. or D. C. Motor for No. 15-125 Machine, Nos. 194321, 194573, 194574, 196917 and four each 140099X and 194407.....
		NOTE: When ordering No. 194583, color required, must be specified.
194584	26013	Controller (foot) complete, for 95 to 145 volts, A. C. or D. C. Motor for No. 15-125 Machine, Nos. 194321, 194573, 194574, 196918 and four each 140099X and 194407.....
		NOTE: When ordering No. 194584, color required, must be specified.
194585	-----	Controller (foot) complete for 150 to 250 volts, A. C. or D. C. Motor, for No. 15-125 Machine, Nos. 194321, 194573, 194574, 196919 and four each 140099X and 194407.....
		NOTE: When ordering No. 194585, color required, must be specified.
194825	26012	Controller Lead complete, 60 inches long for 194827, 194828 and 194829.....
		NOTE: When ordering No. 194825, color required, must be specified.
194827	-----	Controller (convertable for Foot or Knee Control) complete, for 32 to 55 volts, A. C. or D. C. Motor, for No. 15-125 Machine, Nos. 194321, 194573, 194825, 196917 and four each 140099X and 194407
		NOTE: When ordering No. 194827, color required, must be specified.
194828	26012	Controller (convertable for Foot or Knee Control) complete, for 95 to 145 volts, A. C. or D. C. Motor, for 15-125 Machine, Nos. 194321, 194573, 194825, 196918 and four each 140099X and 194407.....
		NOTE: When ordering No. 194828, color required, must be specified.
194829	-----	Controller (convertable for Foot or Knee Control) complete, for 150 to 250 volts, A. C. or D. C. Motor for 15-125 Machine, Nos. 194321, 194573, 194825, 196919 and four each 140099X and 194407.....
		NOTE: When ordering No. 194829, color required, must be specified.
195130	24626	Light Body Snap Ring (small) for 195289..
195141	24626	Light Spring Contact (lead end) for 195349.

No.	Plate	Name
195143	-----	Light Switch Key Snap Ring for 195958.
195163	26020	Bed Extension Grommet (rubber) for 197177.
		NOTE: When ordering No. 195163, color required, must be specified.
195279	24626	Light Lens (Blue Glass) for 195289.
195280	24626	Light Body (upper half) for 195958.
		NOTE: When ordering No. 195280, color required, must be specified.
195281	24626	Light Body (lower half) for 195289.
		NOTE: When ordering No. 195281, color required, must be specified.
195282	24626	Light Shade for 195289.
		NOTE: When ordering No. 195282, color required, must be specified.
195289	26014	Light (Blue Glass) complete (less Lamp) Nos. 50027 ALX, or ALD, 195130, 195279, 195281, 195282, 195349, 195353, 195357, 195957, 195958 and two each 140738X or J, 195352 and 195358.
		NOTE: When ordering No. 195289, color required, must be specified.
195349	26014	Light Lead with Terminal Clips and Spring Contacts complete, for 195289 Nos. 195141 and 195351.
		NOTE: When ordering No. 195349, color required, must be specified.
195351	24626	Light Spring Contact and Holder for 195349.
195352	24626	Light Body Snap Ring (large) for 195289.
195353	26014	Light Bracket for 195289.
		NOTE: When ordering No. 195353, color required, must be specified.
195357	24626	Light Reflector for 195289.
195358	24626	Light Shade Holder for 195289.
		NOTE: When ordering No. 195358, color required, must be specified.
195881	-----	Armature complete, for PJ2-6 Motor.
195882	-----	Armature complete, for PJ2-12 Motor.
195883	-----	Field Coil complete, for PJ2-10 Motor.
		NOTE: When ordering No. 195883, color required, must be specified.
195957	24626	Light Switch Rotating Contact with Cam and Insulation for 195289.
195958	24626	Light Body (upper half) 195280 with 195143, 196240 and 931868 for 195289.
		NOTE: When ordering No. 195958, color required, must be specified.
196196	-----	Armature complete, for PJ2-14 Motor.
196197	-----	Field Coil complete, for PJ2-14 Motor.
		NOTE: When ordering No. 196197, color of lead must be specified.
196240	24626	Light Switch Key for 195958.
		NOTE: When ordering No. 196240, color required, must be specified.

No.	Plate	Name
196690	26020	Switch (Mercury) for 197177.
196691	26020	Switch Clip for 197177.
196692	26020	Bed Extension for 197177.
		NOTE: When ordering No. 196692, color required, must be specified.
196763	26020	Three-Pin Terminal (female half) complete Nos. 196766, 196768, 196769, 198955, three 196767 and four each 1768, 50577 and 140593 for 197185.
		NOTE: When ordering No. 196763, color required, must be specified.
196766	26020	Three-Pin Terminal (female half) Housing (lower) for 196763.
		NOTE: When ordering No. 196766, color required, must be specified.
196767	26020	Three-Pin Terminal (female half) Sleeve for 196763.
196768	26020	Three-Pin Terminal (female half) Housing (upper) for 196763.
		NOTE: When ordering No. 196768, color required, must be specified.
196769	26020	Three-Pin Terminal (female half) Ground Contact for 196763.
196917	-----	Controller Base 196930 with 196939 and two each 23258, 140103X and 931090 for 194827 and 194583.
		NOTE: When ordering No. 196917, color required, must be specified.
196918	26012	Controller Base 196930 with 196940 and two each 23258, 140103X and 931090 for 194828 and 194584.
		NOTE: When ordering No. 196918, color required, must be specified.
196919	-----	Controller Base 196930 with 196941 and two each 23258, 140103X and 931090 for 194829 and 194585.
		NOTE: When ordering No. 196919, color required, must be specified.
196930	26012	Controller Base for 196917, 196918 and 196919.
		NOTE: When ordering No. 196930, color required, must be specified.
196935	26012	Controller Resistance Unit Linkage for 196939, 196940 and 196941.
196937	26012	Controller Resistance Unit Linkage Cross Slide for 196939, 196940 and 196941.
196939	-----	Controller Resistance Unit with Linkage Nos. 1783X, 196935, 196937, 196953 and two each 50587J, 51327J and 193384, for 32 to 55 volts A. C. or D. C. for 196917.
196940	-----	Controller Resistance Unit with Linkage, Nos. 1783X, 196935, 196937, 196954 and two each 50587J, 51327J and 193384 for 95 to 145 volts A. C. or D. C. for 196918.

No.	Plate	Name
196941	-----	Controller Resistance Unit with Linkage, Nos. 1783X, 196935, 196937, 196955 and two each 50587J, 51327J and 193384 for 150 to 250 volts, A. C. or D. C. for 196919.....
196953	-----	Controller Resistance Unit, for 32 to 55 volts, A. C. or D. C. for 196939.....
196954	26012	Controller Resistance Unit, for 95 to 145 volts A. C. or D. C. for 196940.....
196955	-----	Controller Resistance Unit, for 150 to 250 volts, A. C. or D. C., for 196941.....
196961	26019	Brush Spring.....
197015	26020	Switch Insulation, for 197177.....
197149	26019	Field Coil Lead Strain Relief.....
197177	26020	Wiring Harness complete for No. 15-126 Machine, Nos. 195163, 196690, 196692, 197015, 197181, 197184, 197185, 197207, two each 160R, 51746, 90530, 140703, 140766, 196691, 197183, and five 965105
		NOTE: When ordering No. 197177, color required, must be specified.
197181	26020	Lead Cord Clamp with wood screw, for 197177.....
197183	26020	Lead Cord Strain Relief for 197177.....
197184	26020	Lead Cord, with Six Pin Plug complete, from Wiring Outfit to Safety Switch, for 197177.....
197185	-----	Lead Cord with Three-Pin Terminal (female half) complete, from Three-Pin Terminal to Safety Switch, for 197177, Nos. 196763 and 197245.....
		NOTE: When ordering No. 197185, color required, must be specified.
197207	26020	Switch Box, for 197177.....
197245	26020	Lead Cord, for 197185.....
		NOTE: When ordering No. 197245, color required, must be specified.
197303	-----	Field Coil Retainer.....
197459	26019	Motor Frame, with two each 447AL and 882AL.....
		NOTE: When ordering No. 197459, color required, must be specified.
198955	26020	Three-Pin Terminal (female half) Cord Hole Plug, for 196763.....
		NOTE: When ordering No. 198955, color required, must be specified.
701719	26019	Three-Pin Terminal Body (male half) Post Washer for 192797.....
727511	26019	Field Coil Lead Bushing (rubber).....
		NOTE: When ordering No. 727511, color required, must be specified.
931090	-----	Controller Resistance Unit Screw Washer (asbestos) for 196917, 196918 and 196919
931868	-----	Light Switch Key Spring Washer for 195958
965105	26020	Lead Cord Connector, for 197177.....

24626-1/2

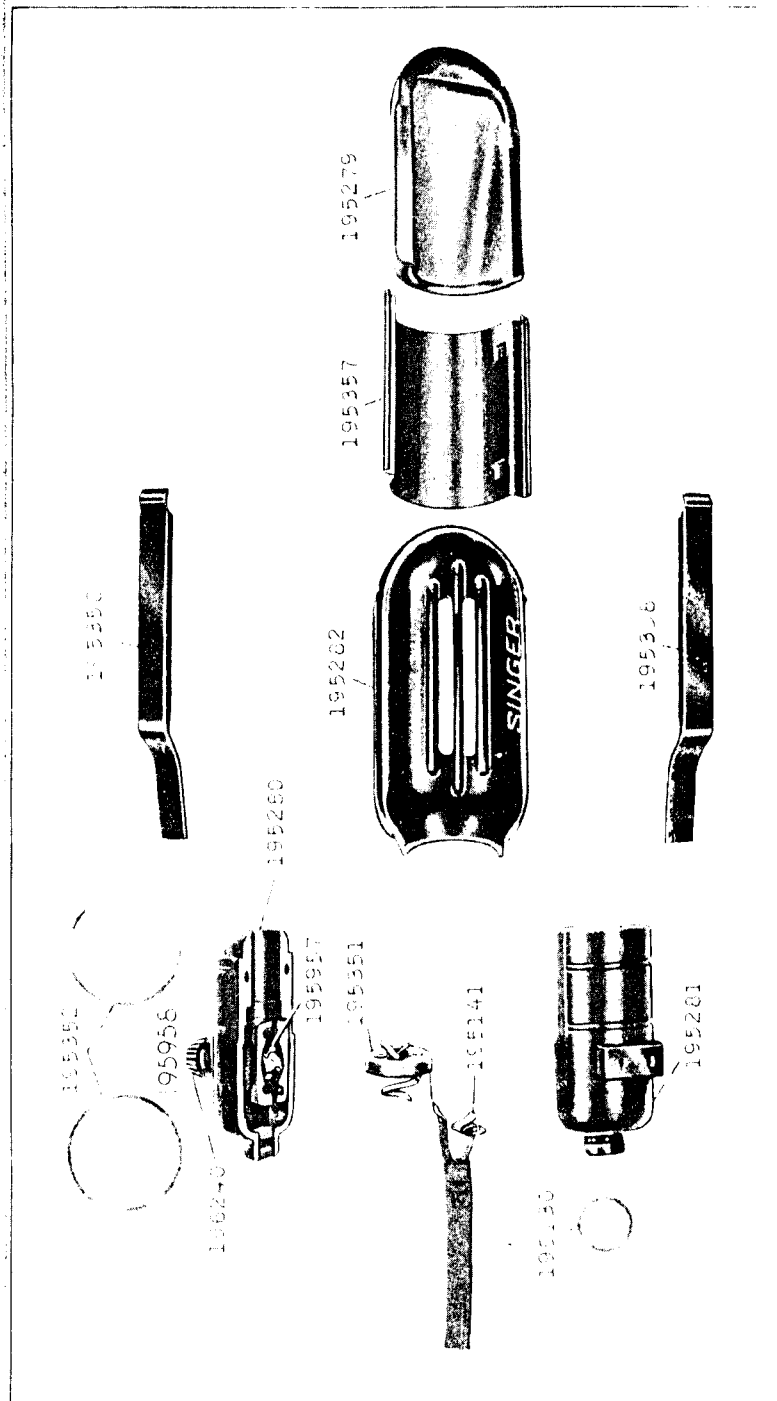

26001-2/3

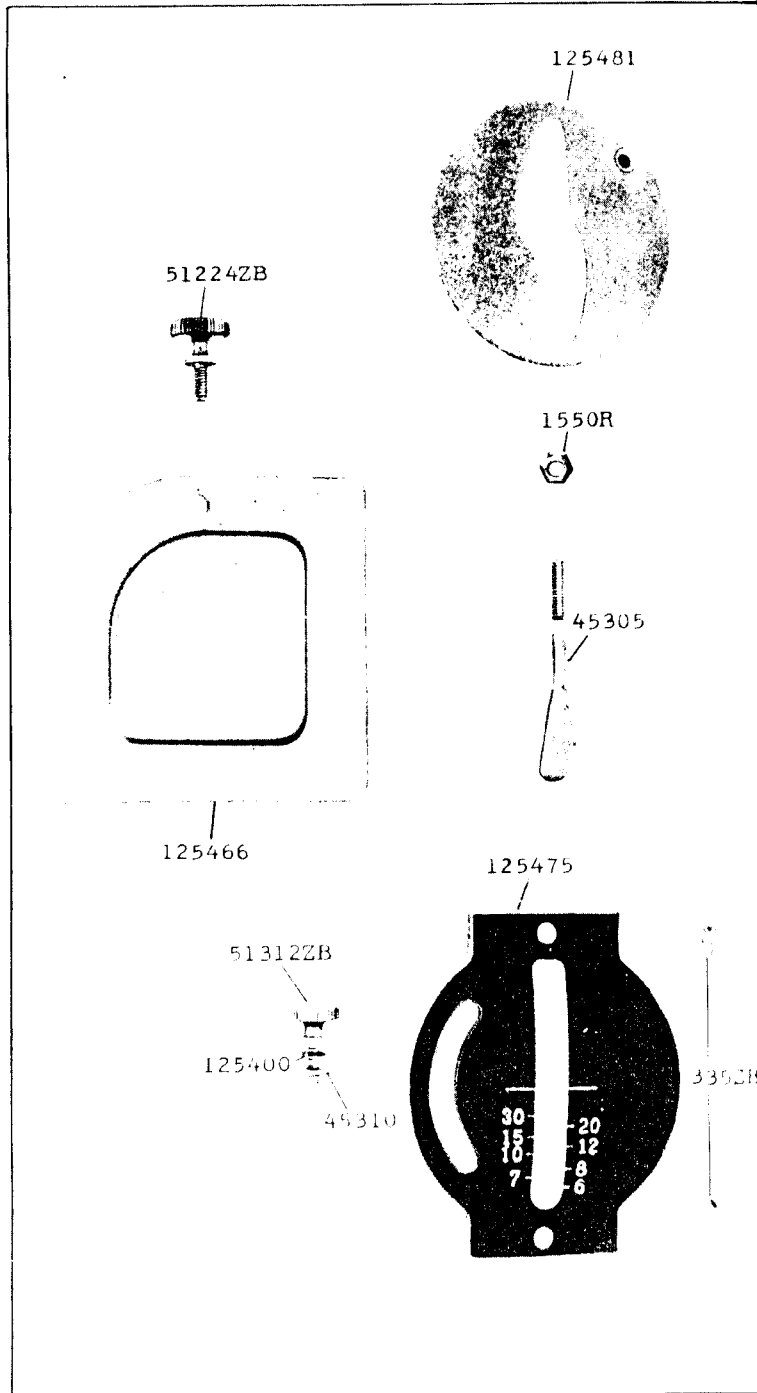

26012-1/2

194828
194825

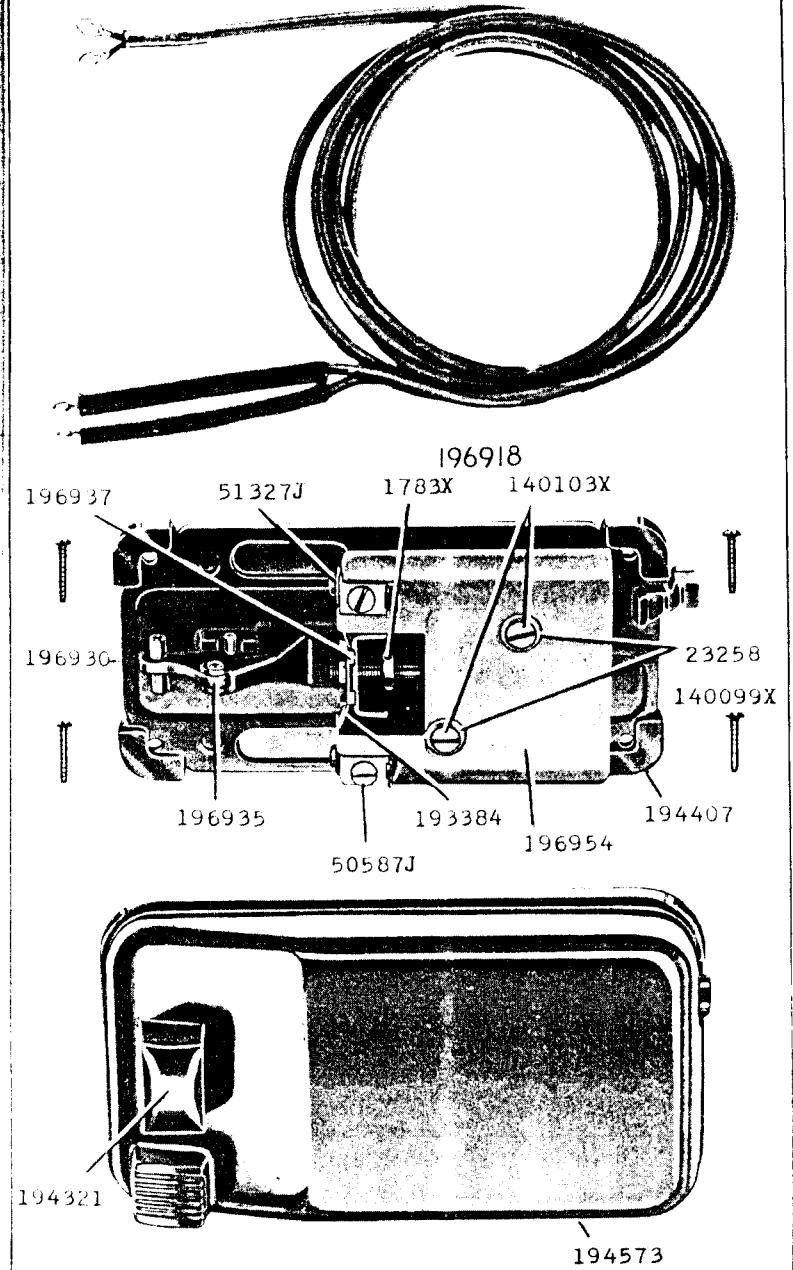

26013-1/3

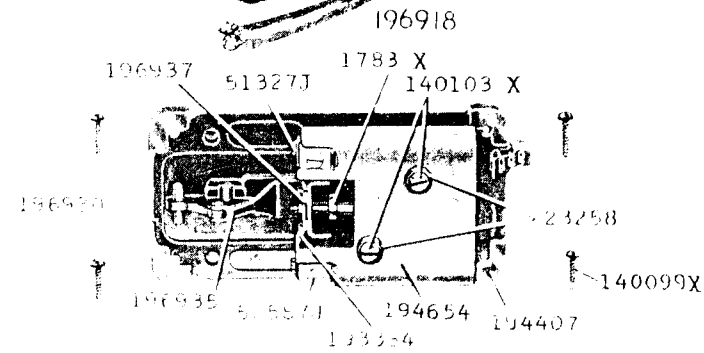
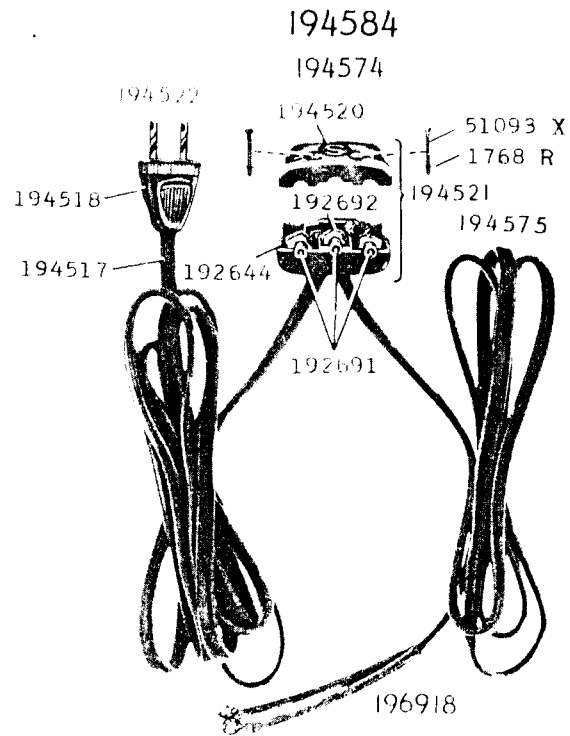

26014-1/2

195289

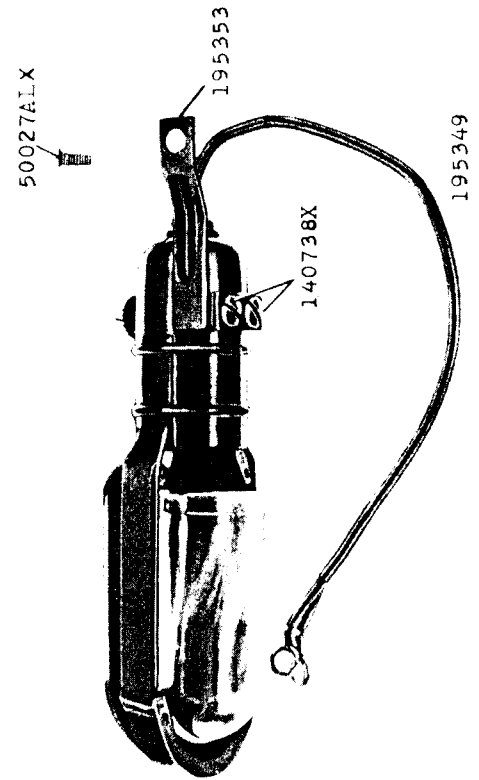

160809

120598

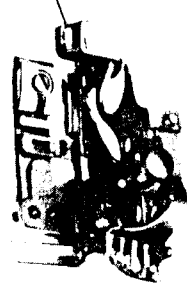

160359



35931

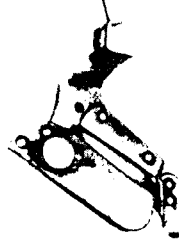

36865



121441



25537

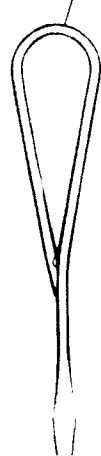

120378



161133



SINGER sewing OIL

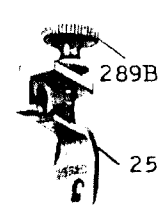

289B



25978



25893

25510



36067

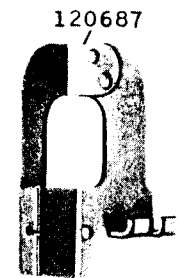

120687

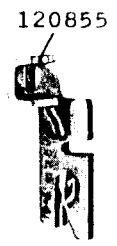

120855

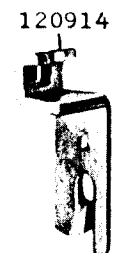

120914



120962

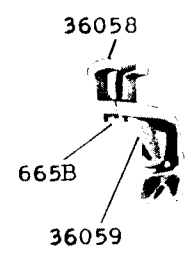

36058

665B

36059

26017-2/3

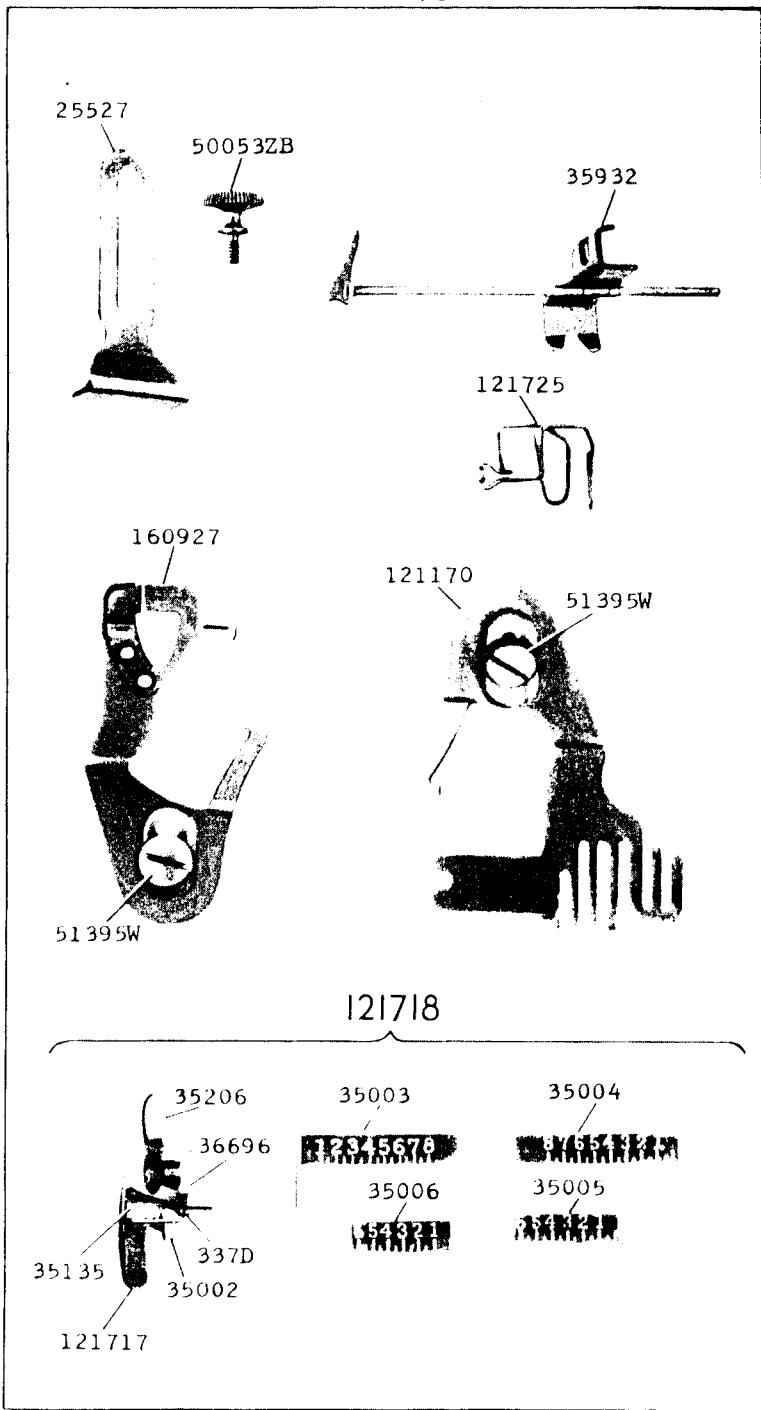

26019-1/3

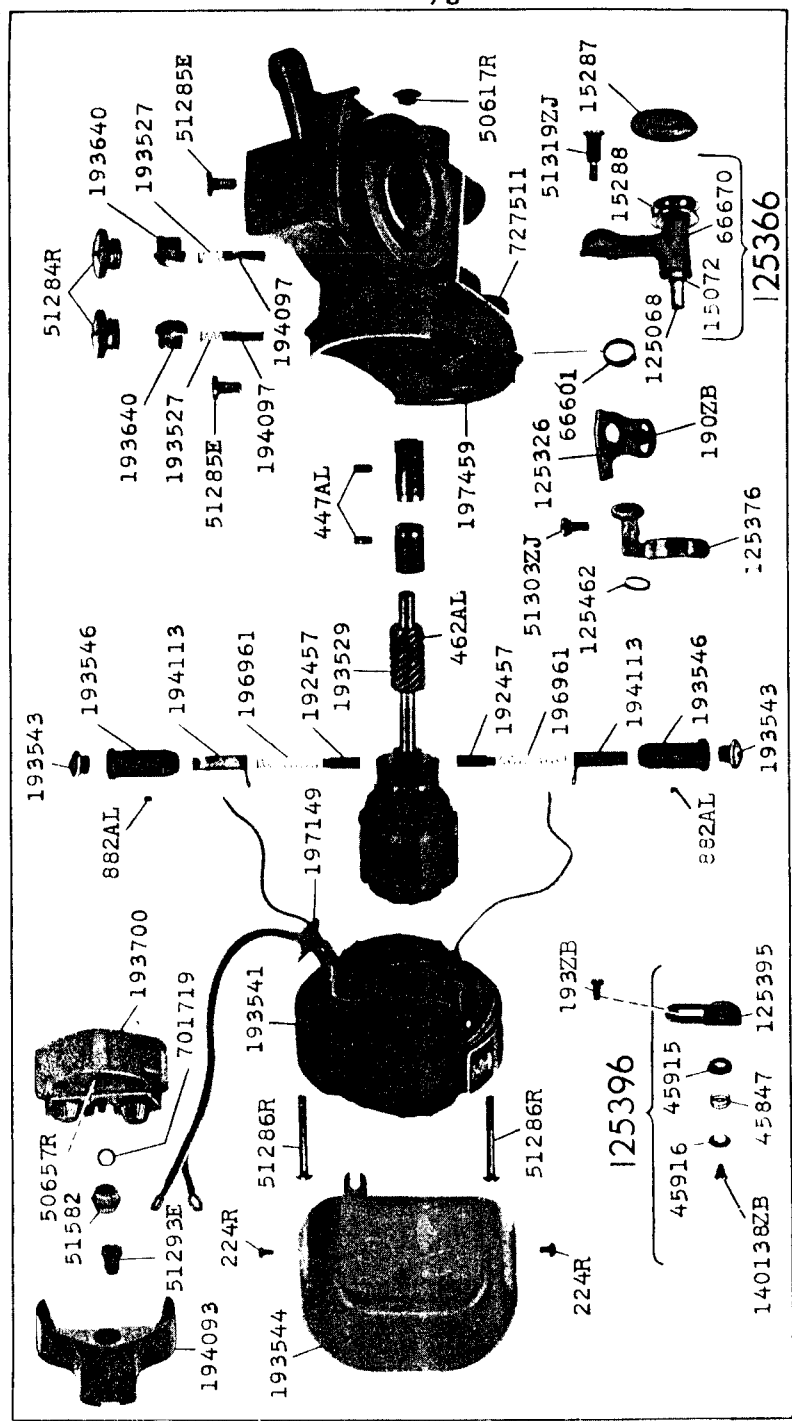

26020-1/3

197177

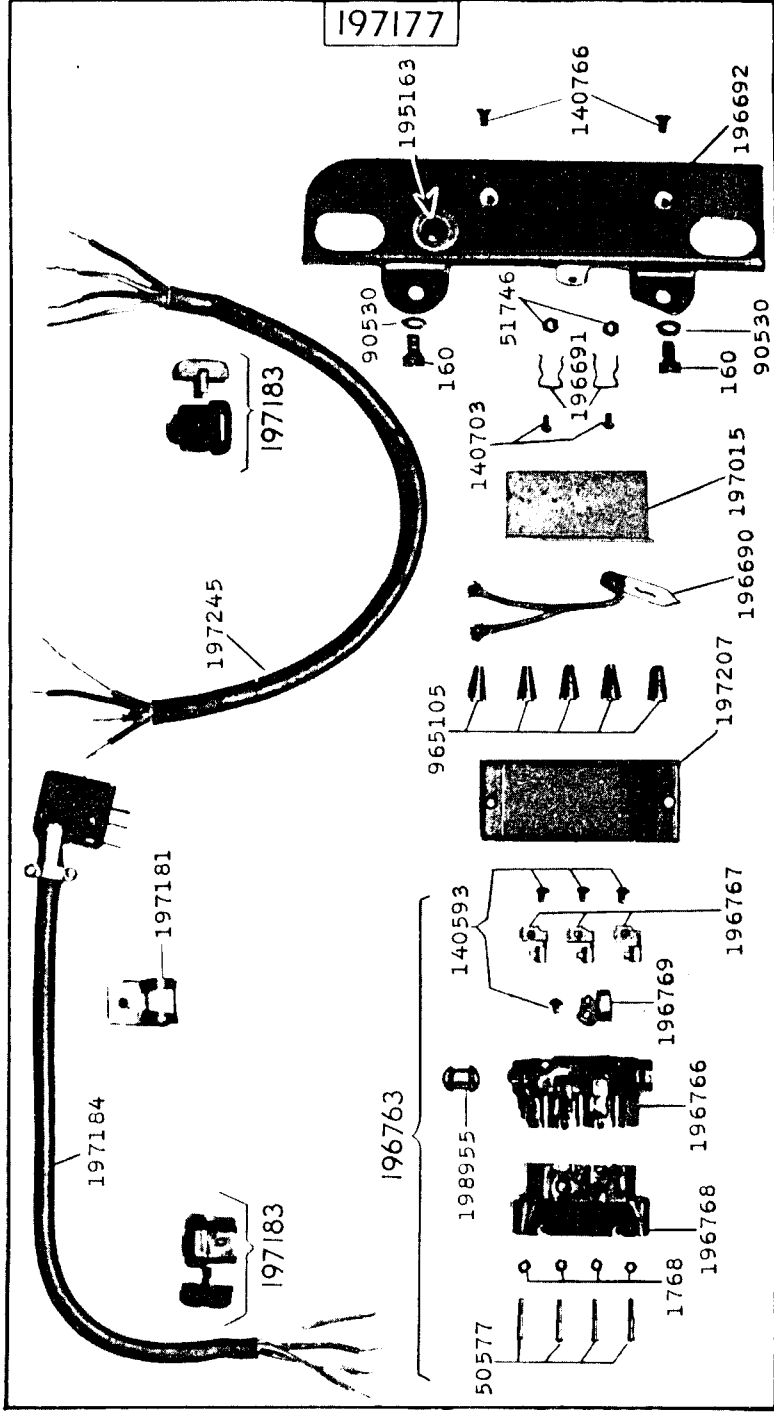

26100-1/3

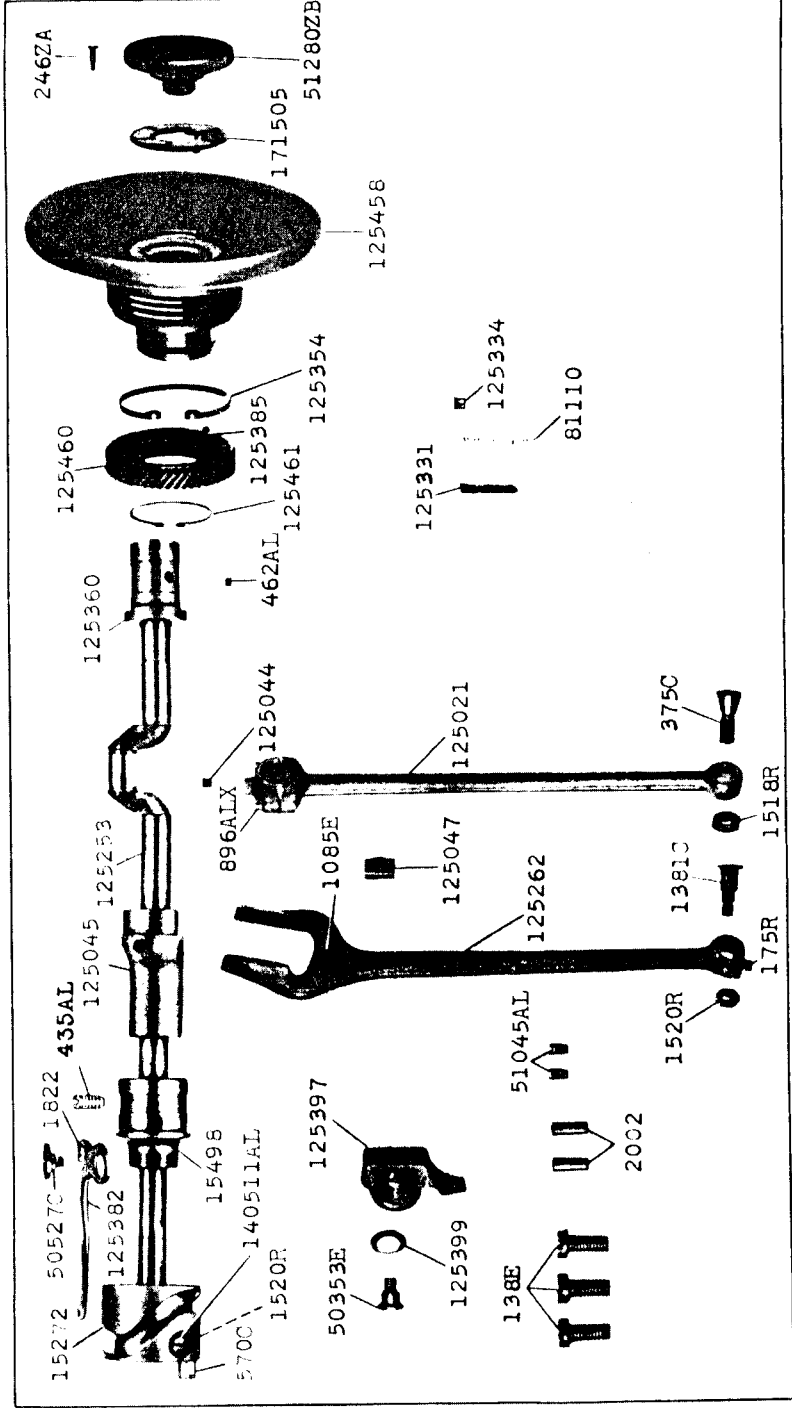

26101-1/2

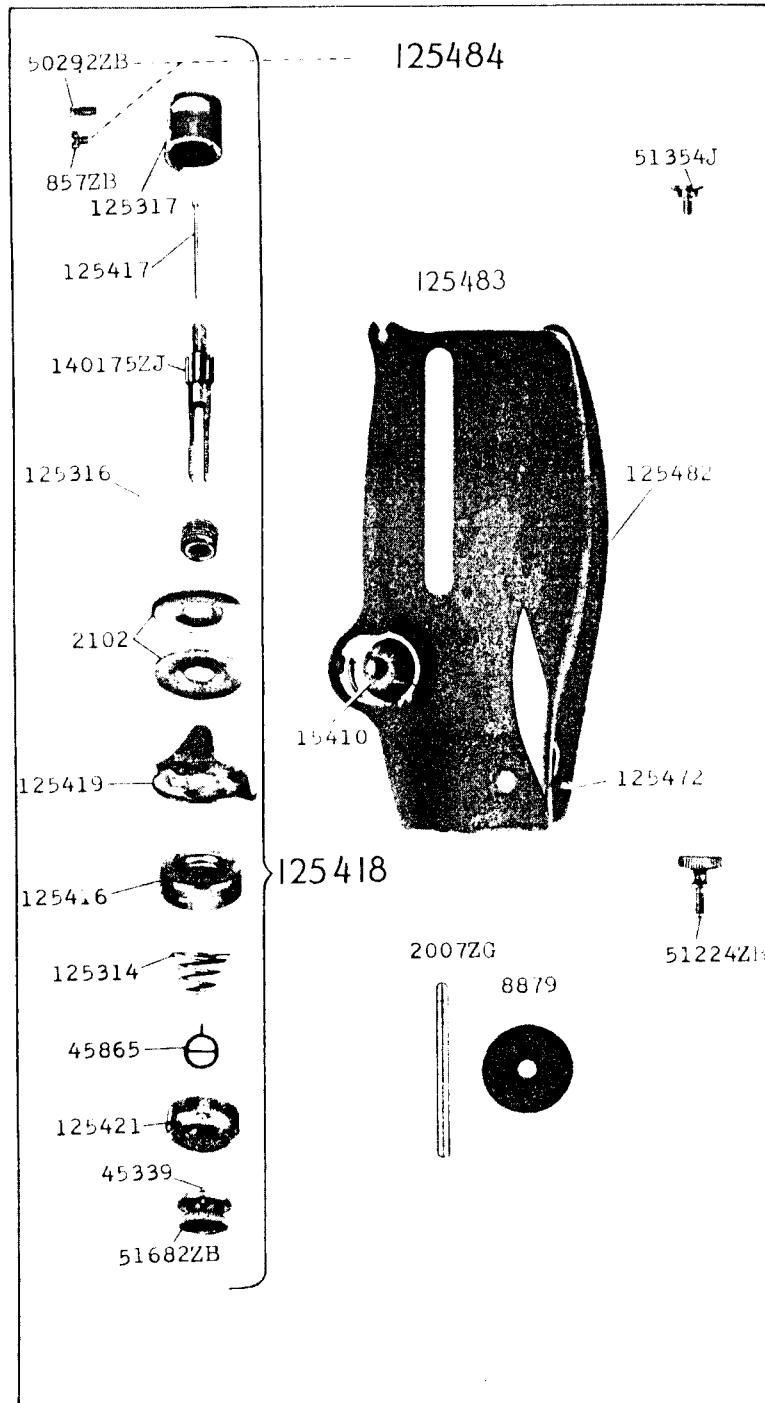

26102-2/3

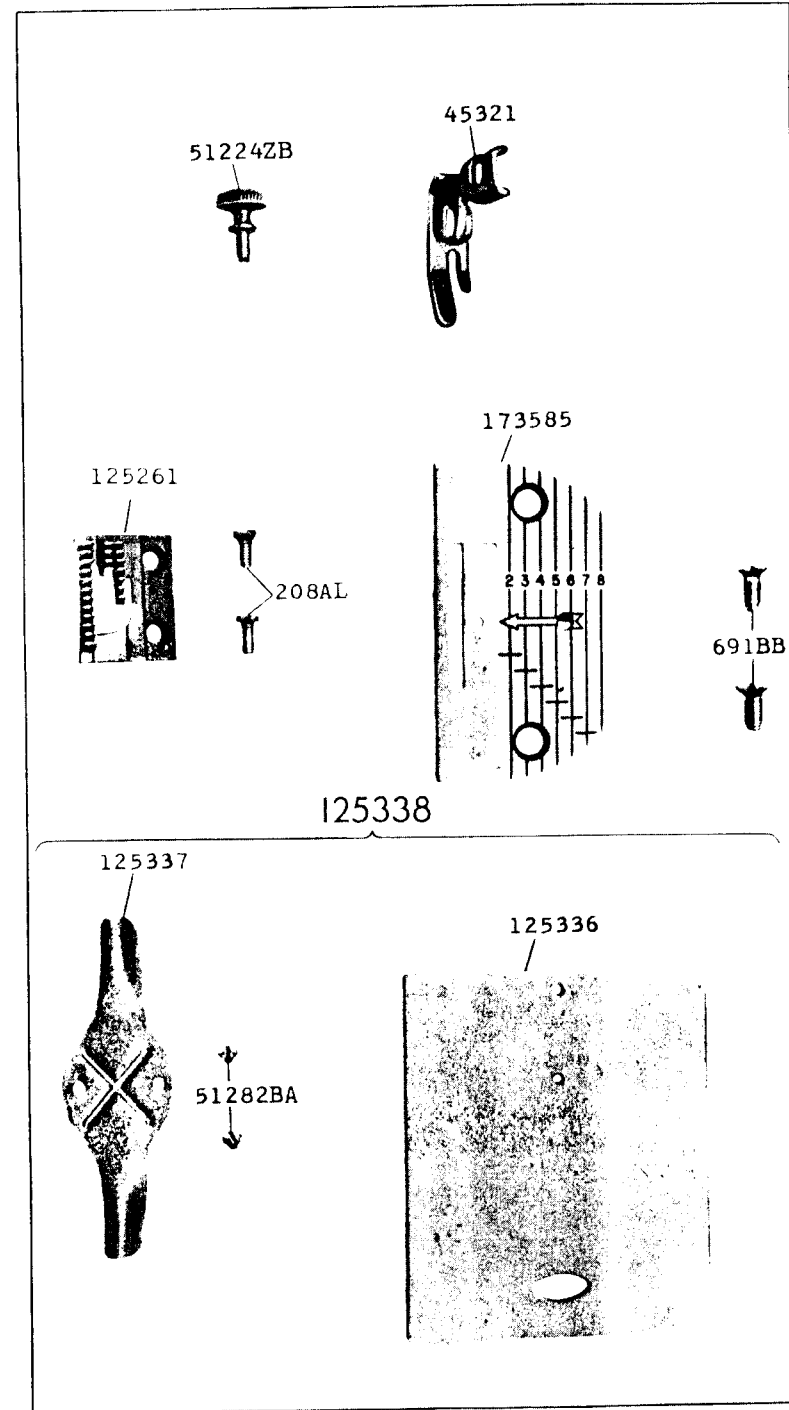

26103-1/2

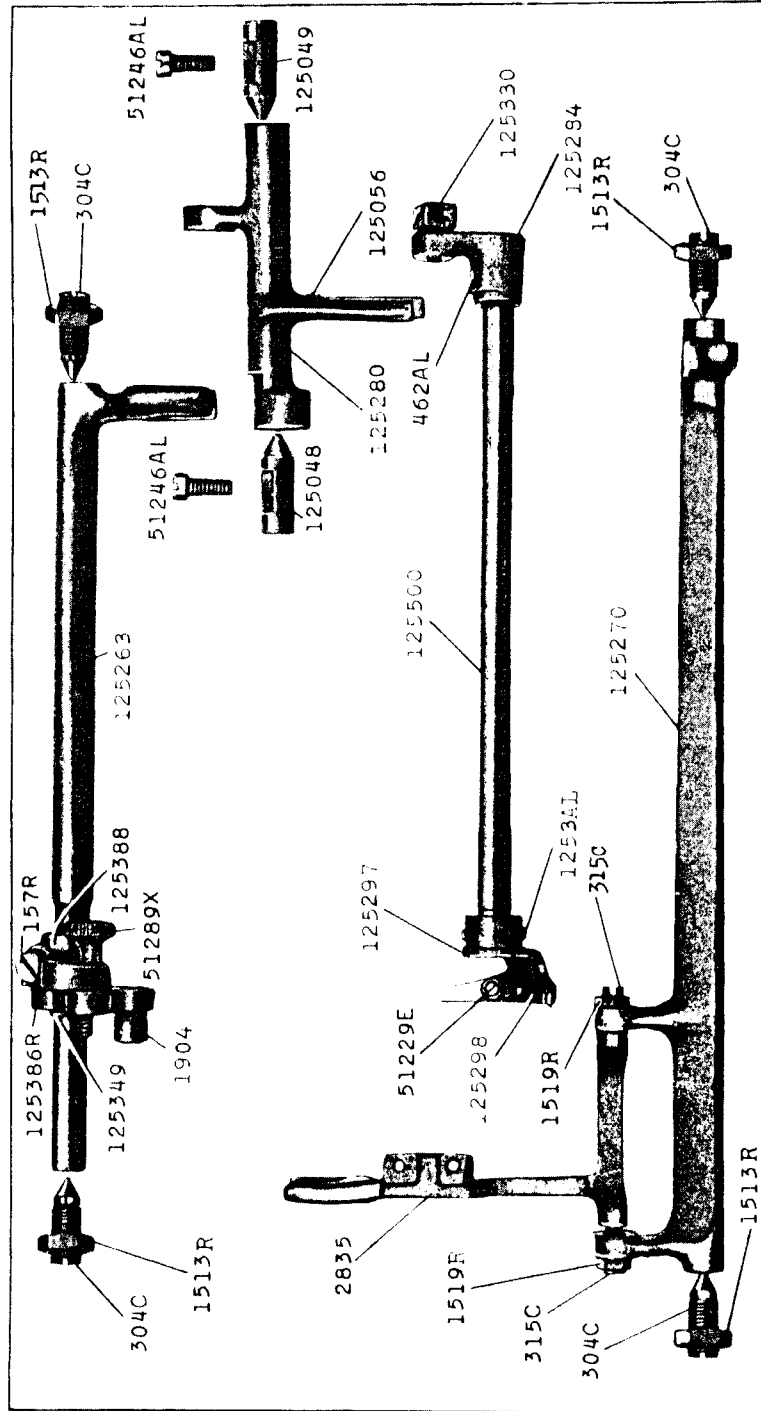

26104-1/2

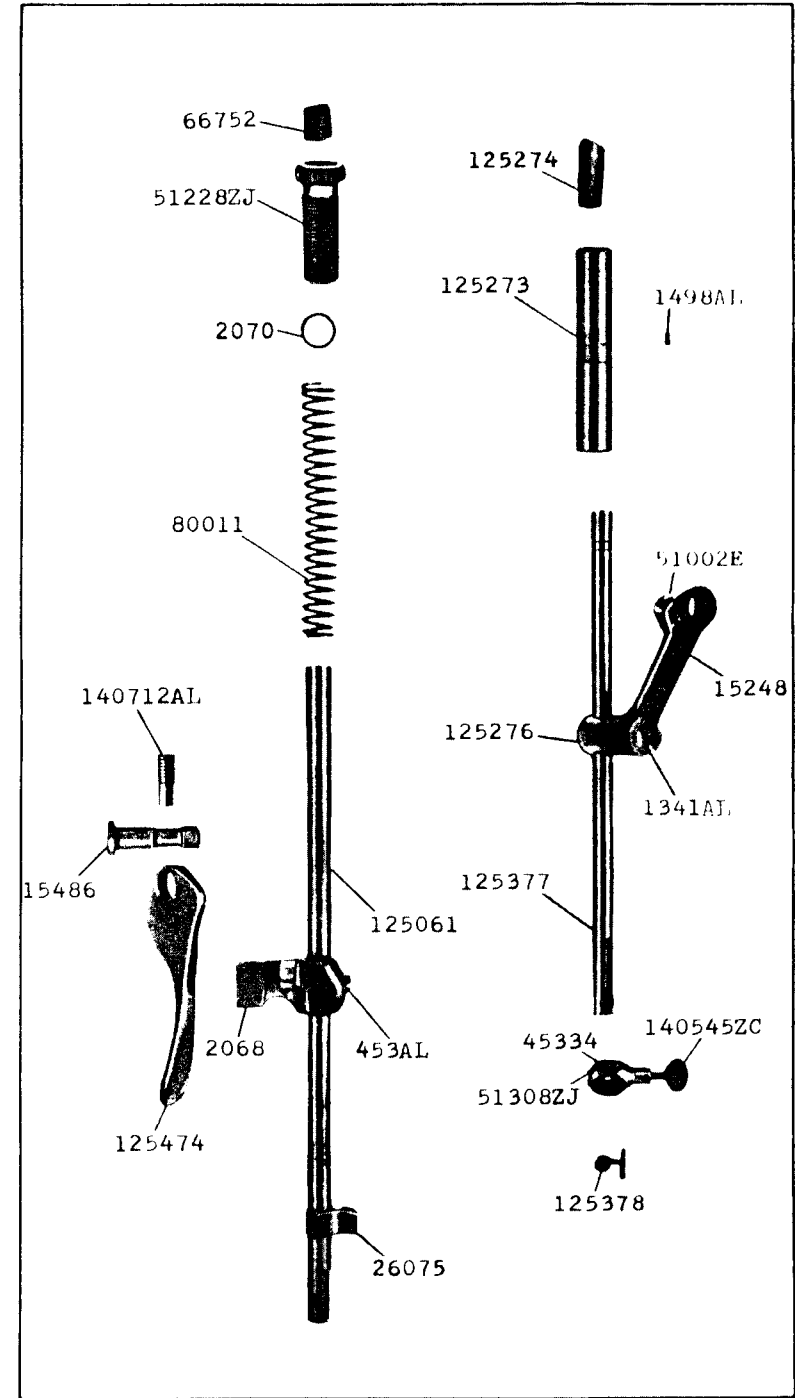

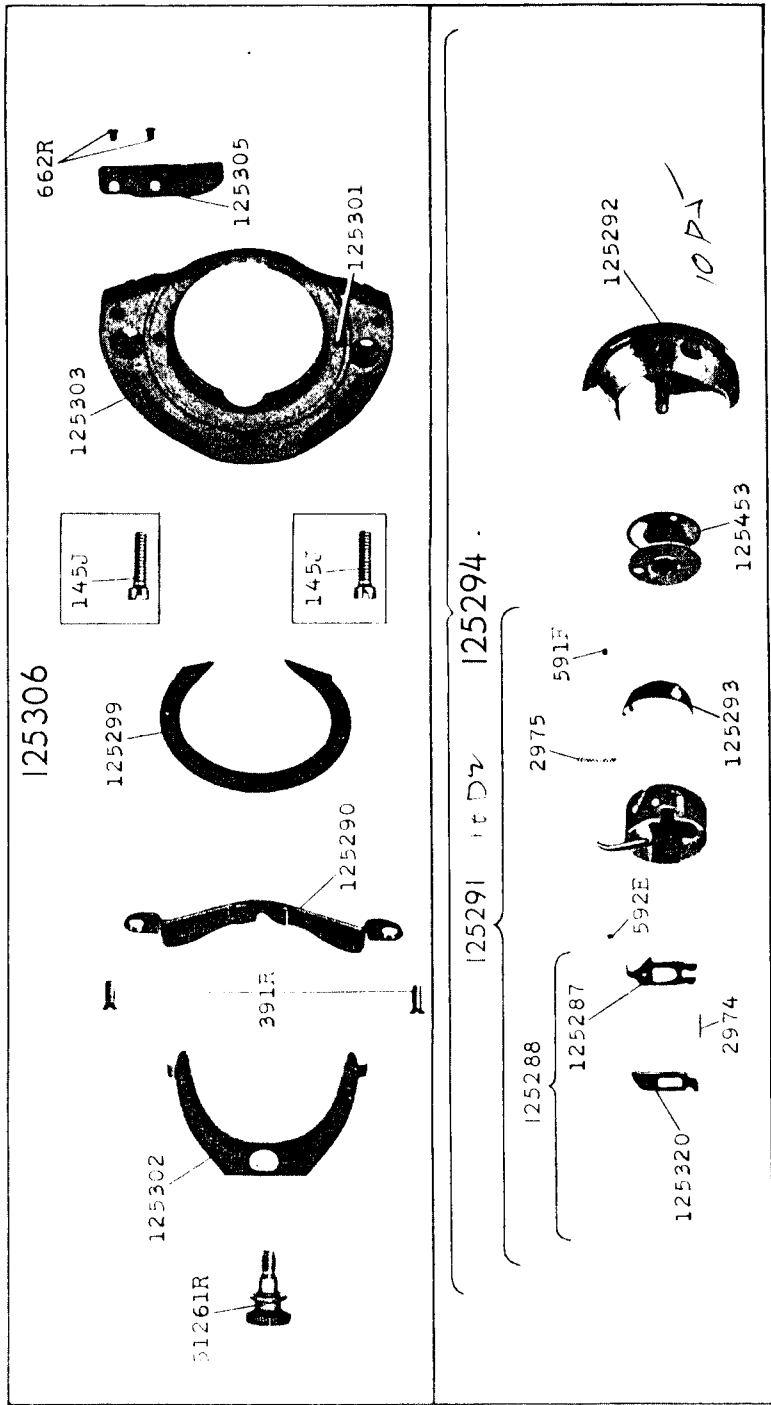

125306