

PFAFF

SRP

Supplement to the instruction
manual and parts list for the
series 1180, 938 U

Reprinting, copying or translation of PFAFF instruction manuals, whether in whole or in part, is not permitted without our prior permission and not without written indication of the source.

PFAFF Industrie Maschinen AG

Postfach 3020

D-67653 Kaiserslautern

Königstr. 154

D-67655 Kaiserslautern

	Page
Contents	Page
1 Proper use	4
2 Controls	5
2.01 Knee switch	5
2.02 Control panel.....	6
2.02.01 Screen displays	6
2.02.02 Function keys	6
2.02.03 Selecting and altering parameters	9
2.02.04 Selecting the user level.....	10
3 Commissioning	11
3.01 Basic position of the machine drive	11
3.02 Testing the function of the start inhibitor.....	12
4 Setting up	13
4.01 Entering the maximum speed	13
4.02 Setting the presser foot pressure	13
4.03 Entering the start and end backtacks.....	14
4.04 Setting the stitch counting function for the bobbin thread control	15
5 Sewing	16
5.01 Manual sewing	16
5.02 Programmed sewing.....	17
5.03 Error messages.....	18
6 Parameter Settings	19
7 Internet update of the machine software	20
8 Reset / Cold start	21
9 Parts list	22
10 Circuit diagrams	23

1 Proper use

The **SRP** system uses a linear motor to adjust the presser foot pressure to the actual sewing speed or workpiece. In addition the presser foot clearance can be adjusted individually. The adjustments are made by altering parameter values, see Chapter **2.02.03 Selecting/altering parameters**.



Any and all uses of this machine which have not been approved of by the manufacturer are considered to be inappropriate! The manufacturer cannot be held liable for any damage caused by the inappropriate use of the machine! The appropriate use of the machine includes the observance of all operational, adjustment, maintenance and repair measures required by the manufacturer!

2 Controls

2.01 Knee switch

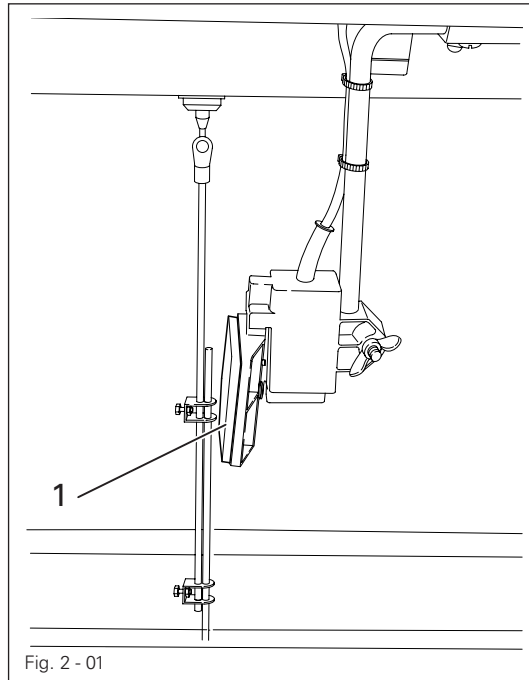

- By operating knee switch 1, the presser foot can be raised when sewing is interrupted.

2.02 Control panel

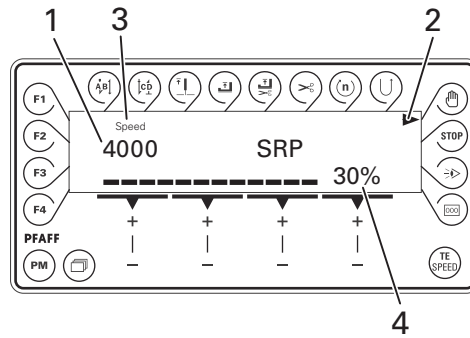

The control panel consists of display 1 and the function keys described below. The display 1 consists of a two-line alpha-numerical LCD display with 16 symbols per line. The texts 3 show the respective status of the function keys and the operating status of the machine. The control panels switches on all LCD-segments and the horn automatically for a short time during the power-on phase, after which the lettering PFAFF appears on the display, until the higher-ranking control unit sends commands to the control panel.

2.02.01 Screen displays

- Activated functions are displayed with a triangular marking 2 below or next to the respective function key.
- In the sewing mode all relevant sewing data is displayed and these can be changed directly, depending on the status of the machine, see also Chapter 5 Sewing.
- During the parameter input the selected parameter number with the corresponding value is displayed, see Chapter 2.02.03 Selecting/changing parameters.

2.02.02 Function keys

The function keys described below are used basically to switch machine functions on and off.

 If a corresponding value has to be set for the activated function, this is carried out with the corresponding +/- key. By pressing and holding the corresponding +/- key, the appropriate numerical value 4 is changed slowly to begin with. If the corresponding +/- key is held down longer, the values change more quickly.



Start backtacks

- If this key is pressed, the backtacks at the beginning of the seam (start backtacks) are switched on or off. The number of forward stitches (A) or reverse stitches (B) for the start backtacks can be changed by pressing the +/- key underneath. To convert from double backtack to single backtack set the corresponding number of stitches at zero.



End backtacks

- If this key is pressed, the backtacks at the end of the seam (end backtacks) are switched on or off. The number of reverse stitches (C) or forward stitches (D) can be changed by pressing the +/- key underneath. To convert from double backtack to single backtack set the corresponding number of stitches at zero.



Needle position

- If this key is pressed the corresponding function is switched on or off. When the function is switched on, the needle positions at t.d.c. after sewing stops.



Foot position after stop

- If this key is pressed the corresponding function is switched on or off. When the function is switched on, the presser foot is raised after sewing stops.



Foot position after trimming

- If this key is pressed the corresponding function is switched on or off. When the function is switched on, the presser foot is raised after thread trimming.



Thread trimmer

- If this key is pressed the thread trimming function is switched on or off.



Speed (only in programmed sewing)

- If this key is pressed the corresponding function is switched on or off. In the seam program the speed is not dependent on the pedal. When the function is switched on, the speed cannot be adjusted by pedal. Sewing can only be carried out at the set maximum speed.
- If the function is switched off, the speed up to maximum speed is adjusted by the pedal.



Reverse sewing

- If this key is pressed the reverse sewing function is switched on or off.



Manual seam (only in programmed sewing)

- If this key is pressed the machine switches to manual sewing. When the function is switched on, the move to the next seam section is not carried out by stitch counting or sensor, but manually with the use of the pedal (position "-2").



Stop

- If this key is pressed the corresponding function is switched on or off. When the function is switched on, the machine stops automatically at the end of a seam section.



Sensor

- In manual sewing the number of compensating stitches from the point where the photo-cell is light to the end of the seam can be set under parameter 111, and in programmed sewing directly.



Stitch counting

- If this key is pressed the corresponding function is switched on or off. The value for the compensating stitches can be changed immediately with the corresponding +/- key. When the function is switched on, the machine moves to the next seam section after sewing the number of stitches entered.



TE/Speed

- In the programmed sewing mode, the number of stitches is entered by stitching them off.
- If this key is pressed once, the machine changes to parameter input.
- If this key is pressed twice (within 5 seconds) the machine changes to stitch input.



Scrolling

- If this key is pressed in the programmed sewing mode, the machine scrolls through the input menus on the display.



PM

- If this key is pressed the programmed sewing function is switched on or off. When the function is switched on, the letters "PM" appear on the display of the control panel. The parameters related to the program are shown in the alpha-numerical part of the display.

F1

- No function assigned

F2

- No function assigned

F3

- No function assigned

F4

- No function assigned

2.02.03 Selecting and altering parameters



- Switch on the machine.
- Press the **TE/Speed** key to call up the parameter input function.

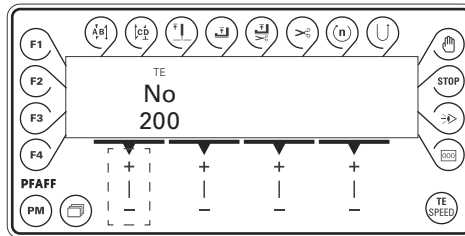

- No
- By pressing the corresponding **+/- key** select the desired parameter group, e.g. "600".

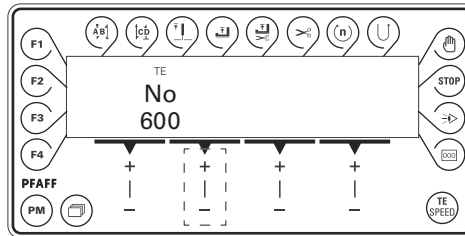

- No
- By pressing the corresponding **+/- key** select the desired parameter, e.g. "660" for the bobbin thread monitoring function.

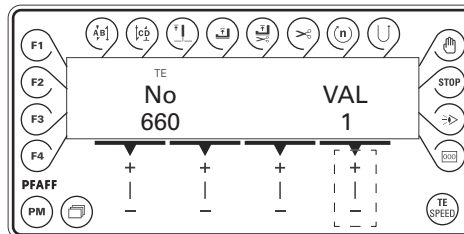

- VAL
- By pressing the corresponding **+/- key** set the desired value for the parameter selected, e.g. "2" for the "bobbin rest thread counter on" function..

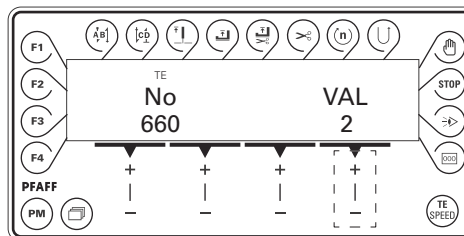

- Press the **TE/Speed** key to take over the value and change to the sewing mode.

2.02.04 Selecting the user level



- Switch on the machine.
- Press the **TE/Speed** key to call up the parameter input function.

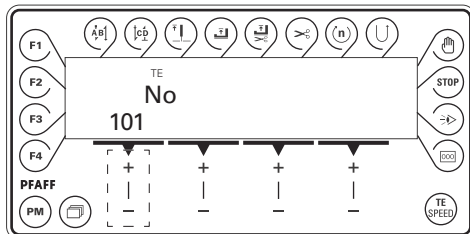

- No
- By pressing the corresponding **+/-** key select the parameter group "700".

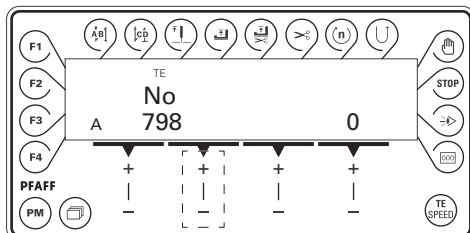

- No
- By pressing the corresponding **+/-** key select the parameter "798".

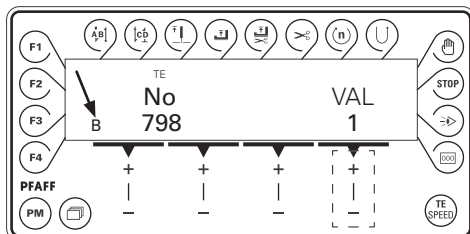

- VAL
- By pressing the corresponding **+/-** key select the desired user level:

- "0" = operator level A
- "1" = technician level B
- "11" = service level C

The respective level is displayed on the screen. (see arrow)



- Press the **TE/Speed** key to take over the value and change to the sewing mode.

3 Commissioning

3.01 Basic position of the machine drive

- Switch on the machine.

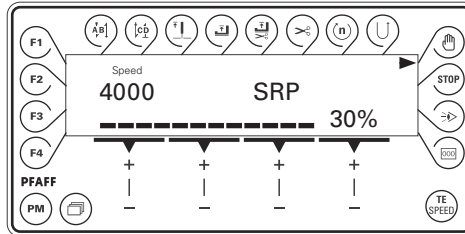

- Press the **TE/Speed** key to call up the parameter input function.
- Select the technician level B (value "1") with parameter "798", see Chapter 2.02.04 **Selecting the user level.**

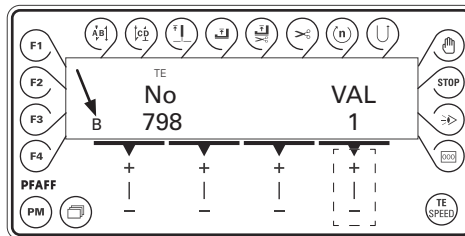

- No
- By pressing the corresponding +/- key select the parameter group "700".

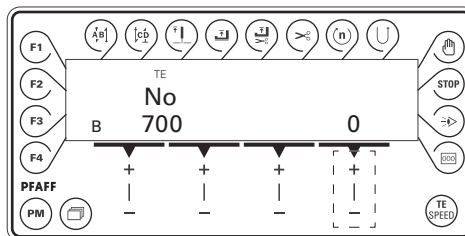

- Sew a stitch by operating the pedal.
- Turn the balance wheel in the direction of sewing until the needle point is level with the top edge of the needle plate.



- Press the **TE/Speed** key to take over the setting and to conclude the input.

3.02 Testing the function of the start inhibitor

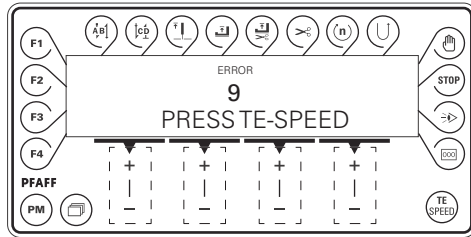

- Switch the machine on at the main switch and tilt back the sewing head. The error message "ERROR 9" must appear on the control panel.
- If the message does not appear, check the setting of the safety switch (in the machine instruction manual).
- Set the sewing head upright again and acknowledge the error message by pressing the TE/Speed key. The machine is ready for operation again.



4 Setting up

4.01 Entering the maximum speed

- Switch on the machine.

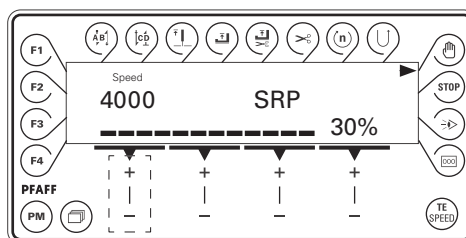

- Enter the maximum speed by pressing the corresponding +/- key.

4.02 Setting the presser foot pressure

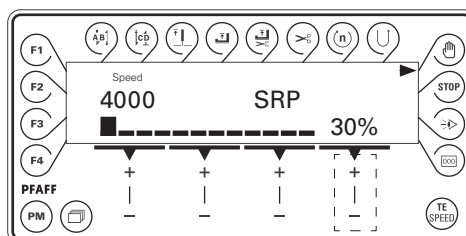

The presser foot pressure is adjusted with the sewing speed. The greater the sewing speed, the higher the pressure foot pressure. By altering the percent increase of the presser foot pressure, the increase of the presser foot pressure can be influenced by an increased sewing speed. The current pressure foot pressure can be seen on the bar graph display.

- Switch on the machine.
- Set the desired percent increase of the presser foot pressure by pressing the corresponding +/- key.

4.03 Entering the start and end backtacks

- Switch on the machine.
- Select the manual sewing mode by pressing the "PM" key.

2x



- Press the **TE/Speed** key twice to select the input menu for start and end backtacks.



In the programmed sewing mode it is possible to call up the input menu for start and end backtacks by pressing the scroll key, see Chapter 5.02 Programmed sewing.

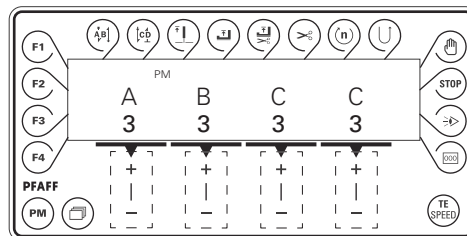

- A ● By pressing the corresponding +/- key select the desired value for the number of forward stitches (A) of the start backtack.
- B ● By pressing the corresponding +/- key select the desired value for the number of reverse stitches (B) of the start backtack.
- C ● By pressing the corresponding +/- key select the desired value for the number of reverse stitches (C) of the end backtack.
- D ● By pressing the corresponding +/- key select the desired value for the number of forward stitches (D) of the end backtack.

4.04 Setting the stitch counting function for the bobbin thread control

2x



- Switch on the machine.
- Press the **TE/Speed** key to call up the parameter input function.

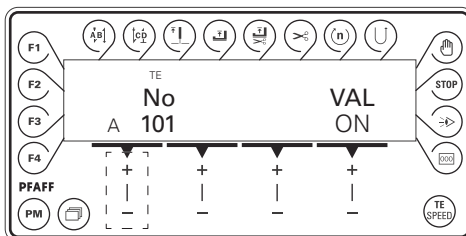

No

- By pressing the corresponding +/- key select the parameter "760".

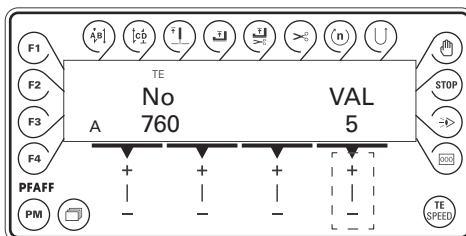

VAL

Press the corresponding +/- key to set the number of remaining stitches, which can still be sewn after recognition by the bobbin thread control function.

The selected value is multiplied by **10*** or **200**** and the result is the number of stitches.

Example display $5 \times 200^{**} = 1000$ stitches. The setting depends among other things on the thread strength.



- If the **TE/Speed** key is pressed, the value is taken over and the machine changes into the sewing mode.



The bobbin thread rest counter can only be used, if parameter "660" is set at value "1" or "2".

* If for parameter 660 the value is "1", the multiplier is 10

** If for parameter 660 the value is "2", the multiplier is 200

5 Sewing





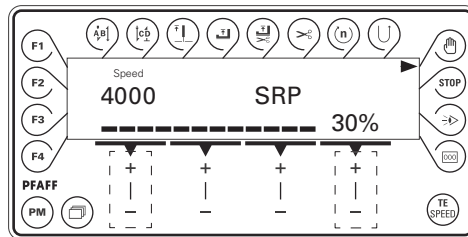

In the sewing mode all relevant adjustments for the sewing operation are shown on the display and can be altered directly. Functions can be switched on and off by pressing the key. In this mode a difference is made between **manual sewing** and **programmed sewing**. To change from manual to programmed sewing, press the PM key. In programmed sewing the text "PM" appears on the display.

5.01 Manual sewing

After the machine has been switched on, the max. speed and presser foot pressure can be adjusted with the corresponding +/- keys.



Further functions in manual sewing, also see Chapter 2.02.02 **Function** keys:

- | | | | |
|---|-------------------------------|---|--|
|  | Start backtacks on/off |  | Presser foot raised after thread trimming on/off |
|  | End backtacks on/off |  | Thread trimming on/off |
|  | Needle position raised on/off |  | Sensor on/off |
|  | Presser foot raised on/off | | |

5.02 Programmed sewing

In the programmed sewing mode **99** programs, each with **9** seam sections and **999** stitches, can be programmed.

The fixed programs are used for the quick and easy production of seams with different numbers of stitches. The pedal setting "0" is used to switch to the next seam section.

PM

After the machine has been switched on and the programmed sewing mode has been selected with the PM key, the display appears for selecting the program number, seam section and number of stitches.

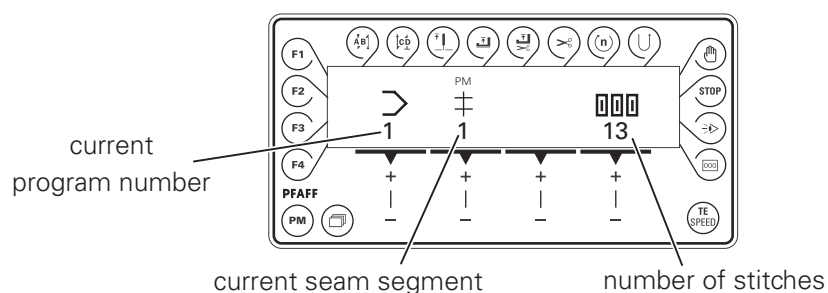

With the scroll key other menus can be selected for entering the values for start and end backtacks and the maximum speed in the corresponding seam section.

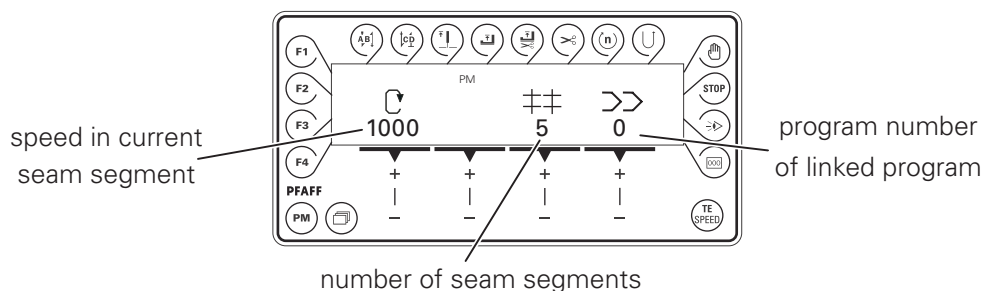

Further functions in programmed sewing, also see Chapter 2.02.02 Function keys:

	Start backtacks on/off		Seam section speed on/off
	End backtacks on/off		Reverse sewing direction on/off
	Needle position raised on/off		Manual sewing on/off
	Presser foot raised on/off		Stop on/off
	Presser foot raised after thread trimming on/off		Sensor on/off
	Thread trimming on/off		Stitch count on/off

5.03 Error messages

If a fault occurs, the text "ERROR" appears on the display, together with an error code and short instructions. An error message is caused by incorrect settings, faulty elements or seam programs as well as by overload conditions.

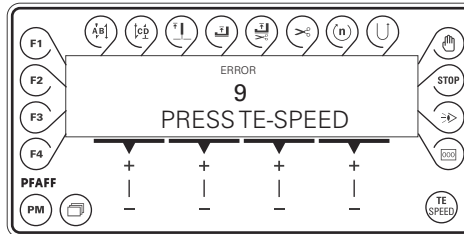

- Correct the error.



- Acknowledge error correction by pressing the TE/Speed key.

6 Parameter Settings

Group	Parameter	Description	Access level	Adjustment range	Standard value
2	251	Presser foot clearance when raised by pedal (pedal position -2)	B, C	0 - 255	160
	252	Presser foot clearance when raised by knee switch	B, C	0 - 255	150
	256	Min. presser foot pressure during sewing	B, C	0 - 32	10
	258	Machine feed type 1 = needle feed, 0 = bottom feed	B, C	0 - 1	0
	287	Presser foot clearance when raised by pedal (pedal position -1)	B, C	0 - 255	150
	288	Presser foot holding pressure while the M/C is stopped	B, C	0 - 255	80
6	607	Maximum speed	B, C	300 - 5500	4000
	660	Bobbin thread monitoring 0 = off 1 = by sensor (-926/06) 2 = by stitch counting	B, C	0 - 2	1180 = 1 938 U = 0
7	700	Needle position 0 (needle reference position)	B, C	0 - 255	*
	702	Needle position 1 (needle lowered)	B, C	0 - 255	90
	703	Needle position 2 (take-up lever raised)	B, C	0 - 255	236
	760	Multiplier for the fixed value (200) for stitch count	A,B, C	0 - 250	5
	799	Selected machine class	C	1 - 2	1
8	800	Rotating direction of the motor	C	0 - 1	0
9	985	Switch on angle for thread trapper	B,C	0 - 255	67
	986	Switch off angle for thread trapper	B,C	0 - 255	206
	989	Thread trapper at beginning of seam 1 = yes, 0 = no	B,C	0 - 2	0

* Adjustment see Chapter 3.01 Basic position of the machine drive unit.



The standard values listed in the table are basic settings, which can be altered if necessary.
For more displays and information see the motor instruction manual.

7 Internet update of the machine software

The machine software can be updated with PFAFF flash programming. For this purpose the PFP boot program and the appropriate control software for the machine type must be installed on a PC. To transfer the data to the machine, the PC and the machine control unit must be connected with an appropriate null modem cable (part no. **91-291 998-91**).



The PFP boot program and the control software of the machine type can be downloaded from the PFAFF-homepage using the following path:
www.pfaff-industrial.com/pfaff/de/service/downloads

To update the machine software carry out the following steps:



While the machine software is being updated, no setting up, maintenance or adjustment work may be carried out on the machine!

- Switch off the machine.
- Connect the PC (serial interface or appropriate USB-adapter) and the machine control unit (RS232).
- Switch on the PC and start the PFP boot program.
- Select the machine type.
- Press the "programming" button.
- An auxiliary program (Quickloader) is started.
- Switch on the machine within **60** seconds.
- The software update is carried out, the updating status is shown on the bar display.
- After the update has been completed, the message "Software updated successfully completed" appears.



If this message does not appear, the entire procedure must be repeated!
The operational reliability of the machine is not restored until the programming has been carried out successfully and without errors.

- Switch off the machine, end the quickloader and PFP-boot program.
- End the connection between the PC and the machine control unit.
- Switch on the machine.

A plausibility control is carried out and, if necessary, a cold start.



More information and assistance is at your disposal in the file "PFPHILFE.TXT", which can be called up from the PFP boot program by pressing the "help" button.

8 Reset / Cold start

After selecting the reset menu, by pressing the corresponding key it is possible to delete seam parameters, to delete seam programs or to carry out a cold start.

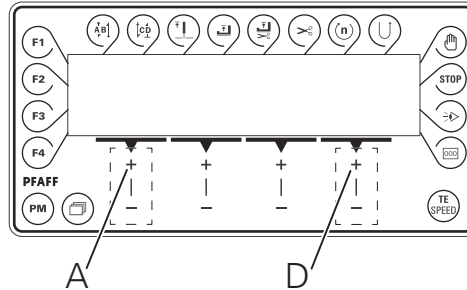

- Press and hold "+" on keys A and D and switch on the machine.

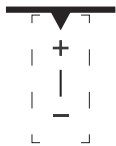
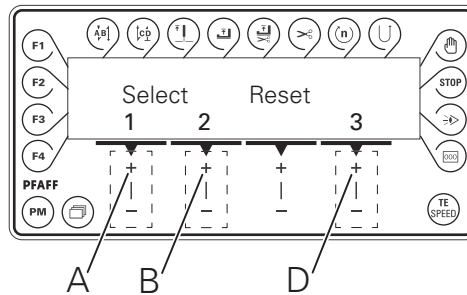

1 = Resetting the seam parameters

- Press "+" on key A.
All seam parameters are deleted, "MASTER-RESET 1" is displayed for a short time on the screen.



2 = Resetting the seam programs

- Press "+" on key B.
All seam programs are deleted, "MASTER-RESET 2" is displayed for a short time on the screen.



3 = Cold start

- Press "+" on key D.
The values of the machine control unit are set back to their basic values, except the value for the machine class. "COLD START" is displayed for a short time on the screen.



After a cold start, all programmed values are reset to their state at the time of delivery. For this reason, after a cold start, the parameters 799, 800 and 700 must be checked and reset if necessary.

Parts list

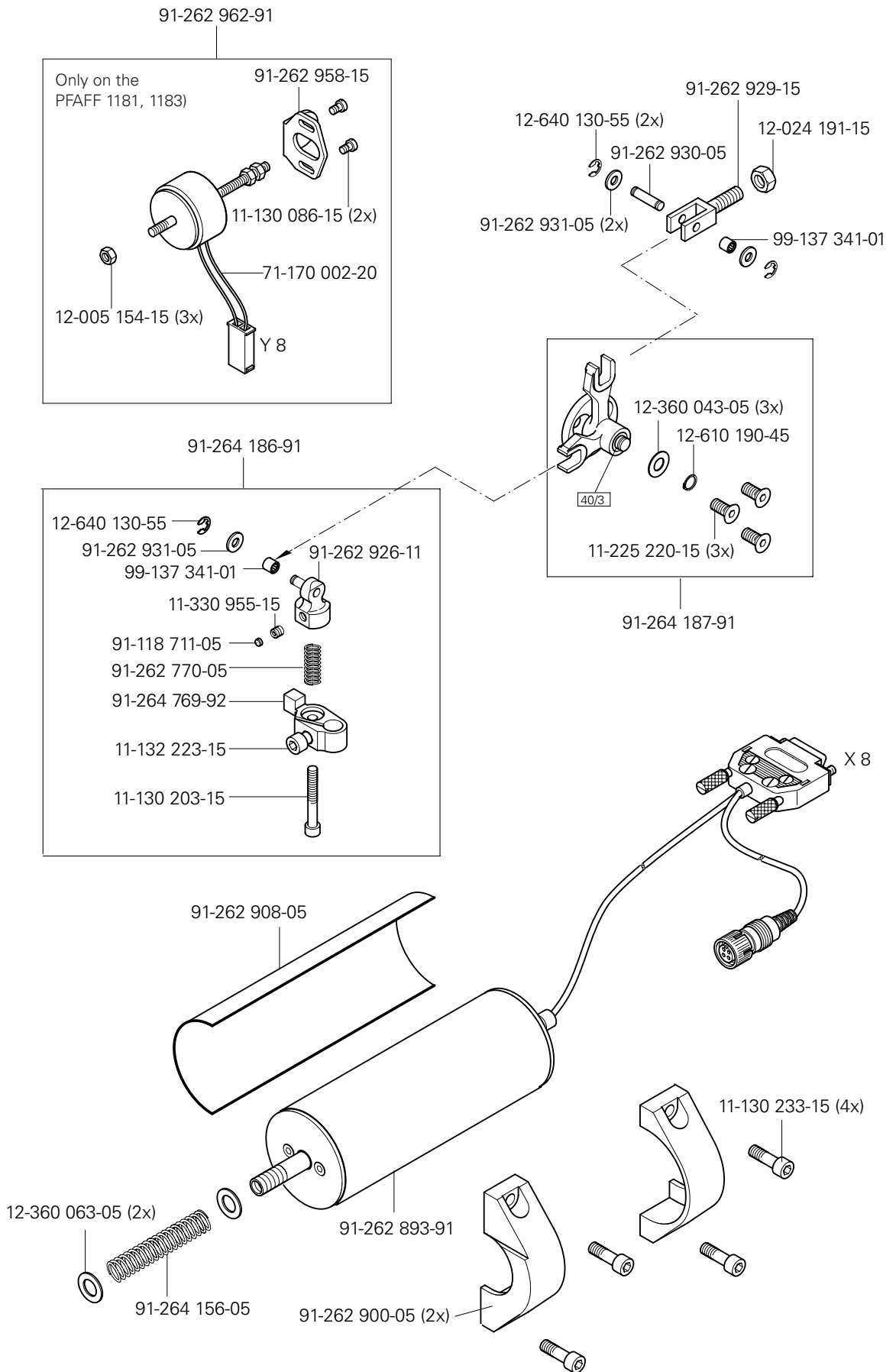

10 Circuit diagrams

10.01 Reference lists for the circuit diagrams of the 938 U
(Connection diagram 91-191 478-95)

A1	Controller Quick P50 ED
A2	Control panel BDF S2
A14	Sewing head recognition unit (OTE)
B1	Initiator zig-zag stitch control
H1	Sewing lamp
H10	LED Stitch counter
M1	Sewing motor
M2	Linear motor SRP
Q1	Main switch
S1	Pedal set value transmitter
S2	SRP knee switch
S6	Start inhibitor key
S41	Manual backtacking key
S42	Needle position change key (threading key)
S43	Single stitch switch
X0	PC-interface (RS 232)
X1	M1 Sewing motor
X2	M1 Incremental transmitter
X3	S1 Speed control unit
X4	Control panel BDF S2
X5	Outputs-Inputs
X6	Bobbin thread monitor (optional)
X7	Light barrier (optional)
X8	M2 SRP
X12	S2 SRP knee switch
X22	Y2 -900/.. Thread trimmer (FS)
X24	Y4 -910/.. Automatic foot lift
X25	Y5 -911/.. Backtacking
X28	Y8 Thread tension release (FSL)
X40	S4. Keyboard
X46	S6 Start inhibitor
X50	A14 Sewing head recognition unit (OTE)
Y2	-900/.. Thread trimmer
Y4	-910/.. Automatic foot lift
Y5	-911/.. Backtacking
Y8	Thread tension release (FSL)

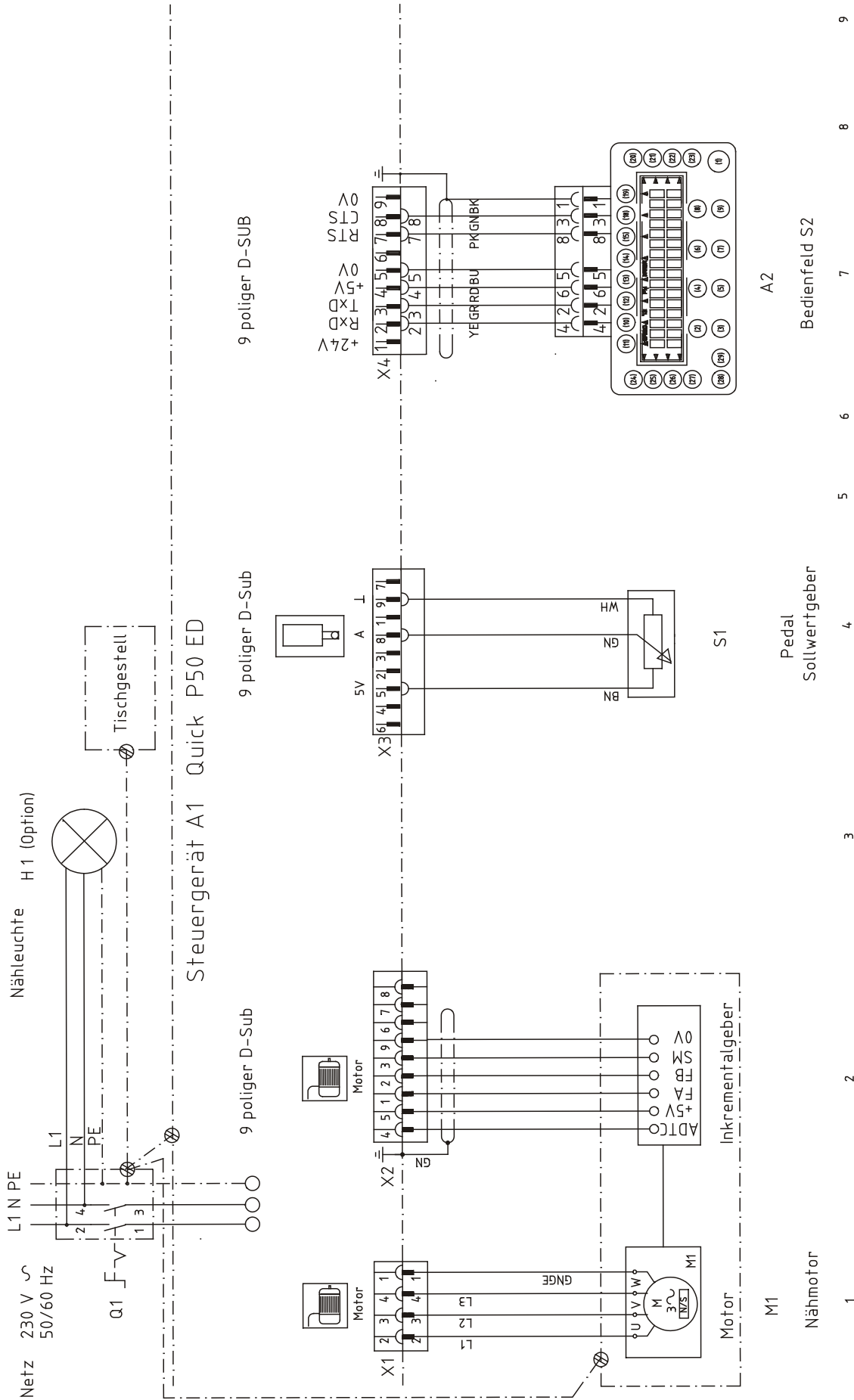

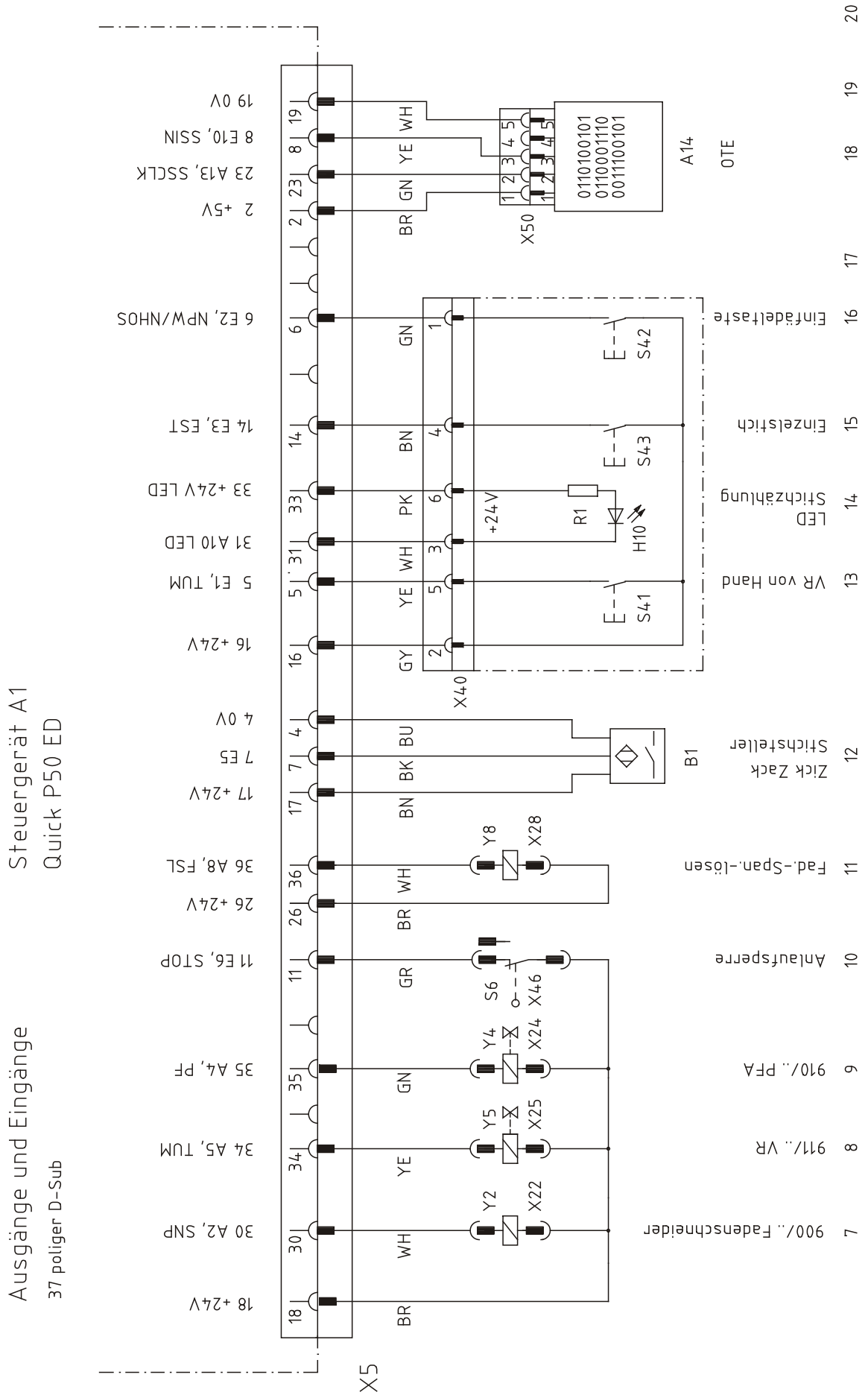

Steuergerät A1 Quick P50 ED

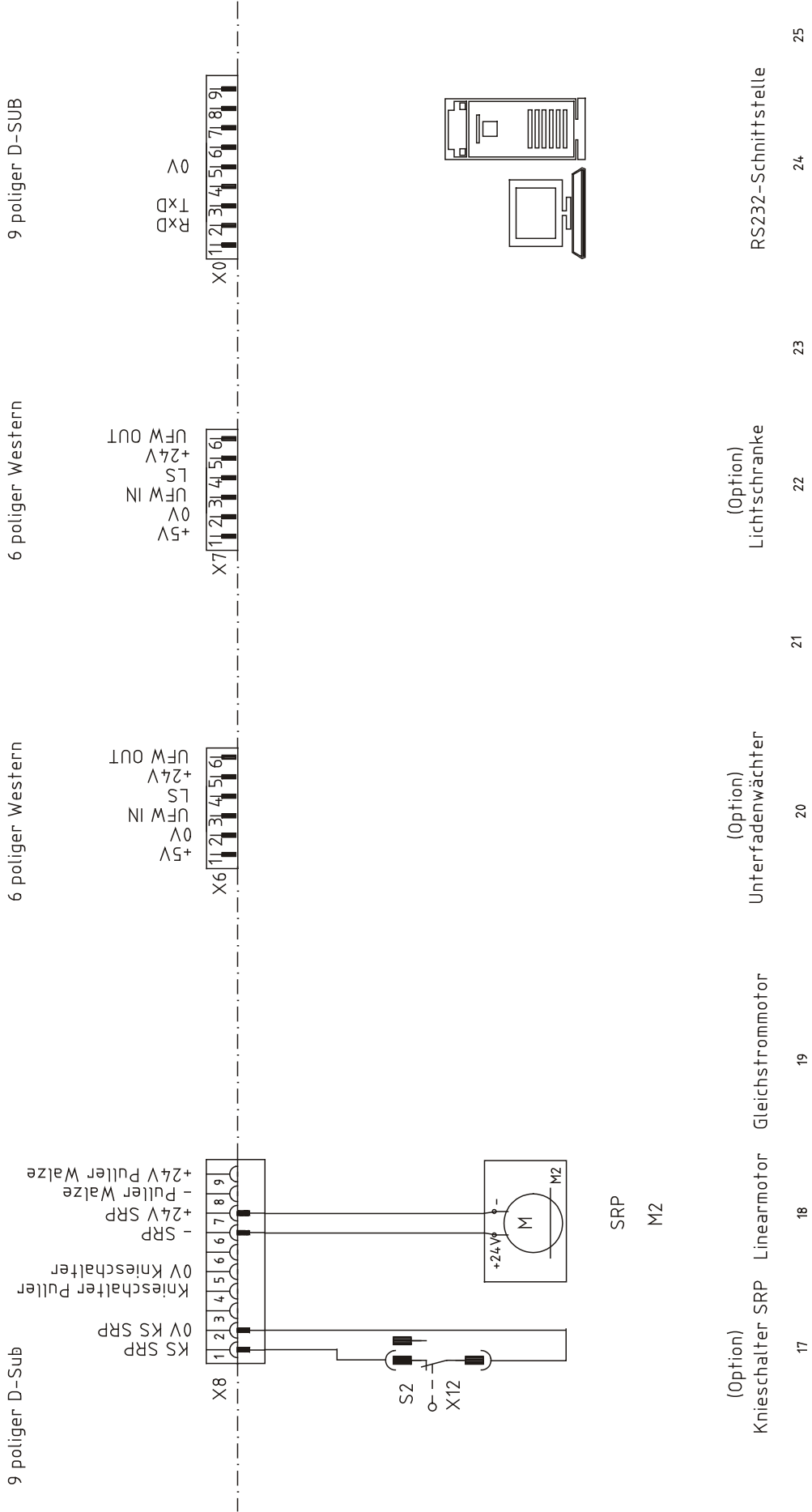

10.02 Reference lists for the circuit diagrams of the 1181 and 1183

(Connection diagram 91-191 517-95)

A1	Controller Quick P50 ED
A2	Control panel BDF S2
A14	Sewing head recognition unit (OTE)
H1	Sewing lamp
H10	LED Stitch counter
M1	Sewing motor
M2	Linear motor SRP
Q1	Main switch
S1	Pedal set value transmitter
S2	SRP knee switch
S6	Start inhibitor key
S41	Manual backtacking key
S42	Needle position change key (threading key)
S43	Single stitch switch
X0	PC-interface (RS 232)
X1	M1 Sewing motor
X2	M1 Incremental transmitter
X3	S1 Speed control unit
X4	A2 Control panel BDF S2
X5	Outputs-Inputs
X6	Bobbin thread monitor (optional)
X7	Light barrier (optional)
X8	M2 SRP
X12	S2 SRP knee switch
X22	Y2 -900/.. Thread trimmer (FS)
X24	Y4 -910/.. Automatic foot lift
X25	Y5 -911/.. Backtacking
X28	Y8 Thread tension release (FSL)
X40	S4. Keyboard
X46	S6 Start inhibitor
X50	A 14 Sewing head recognition unit (OTE)
Y2	-900/.. Thread trimmer
Y4	-910/.. Automatic foot lift
Y5	-911/.. Backtacking
Y8	Thread tension release (FSL)

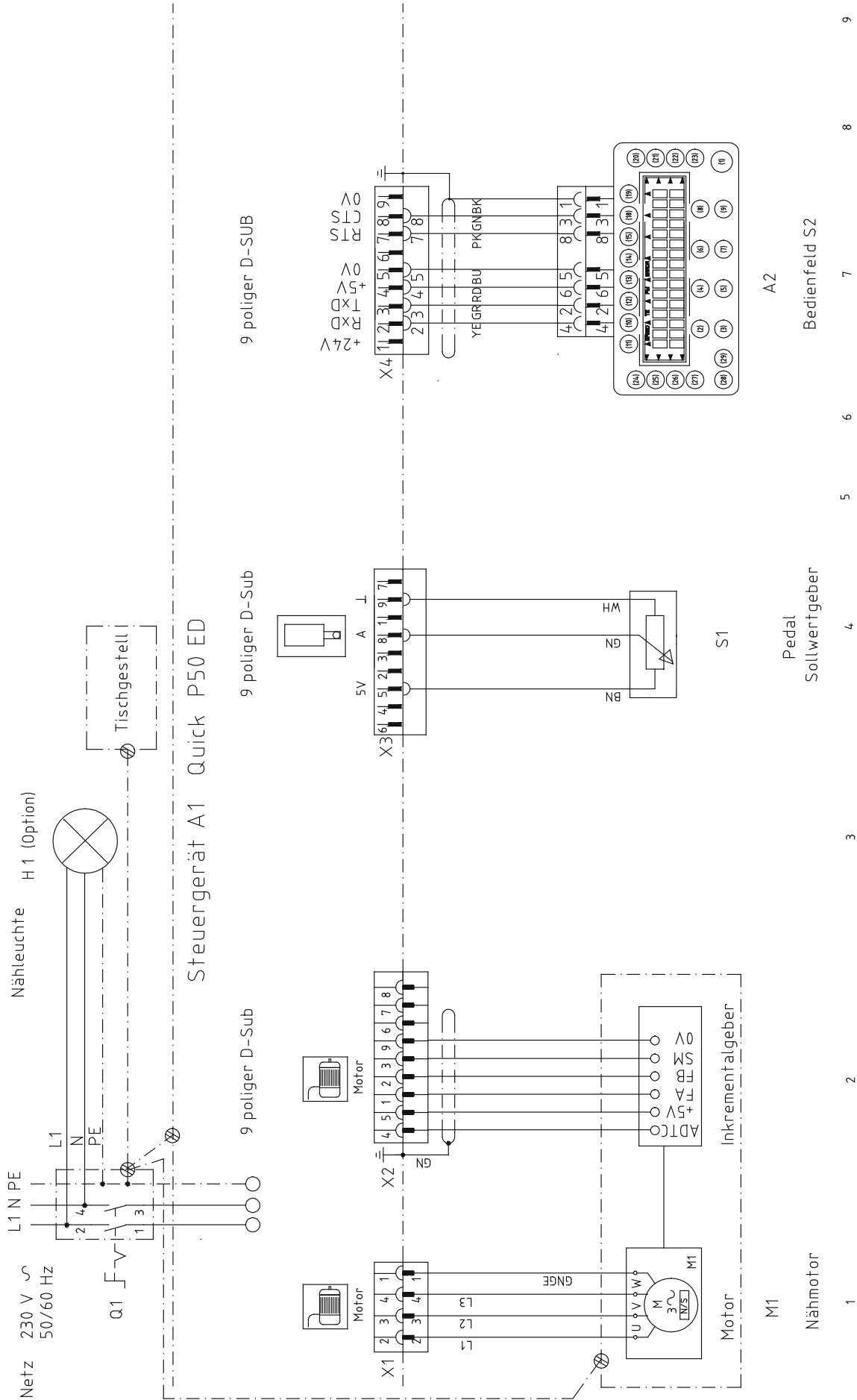

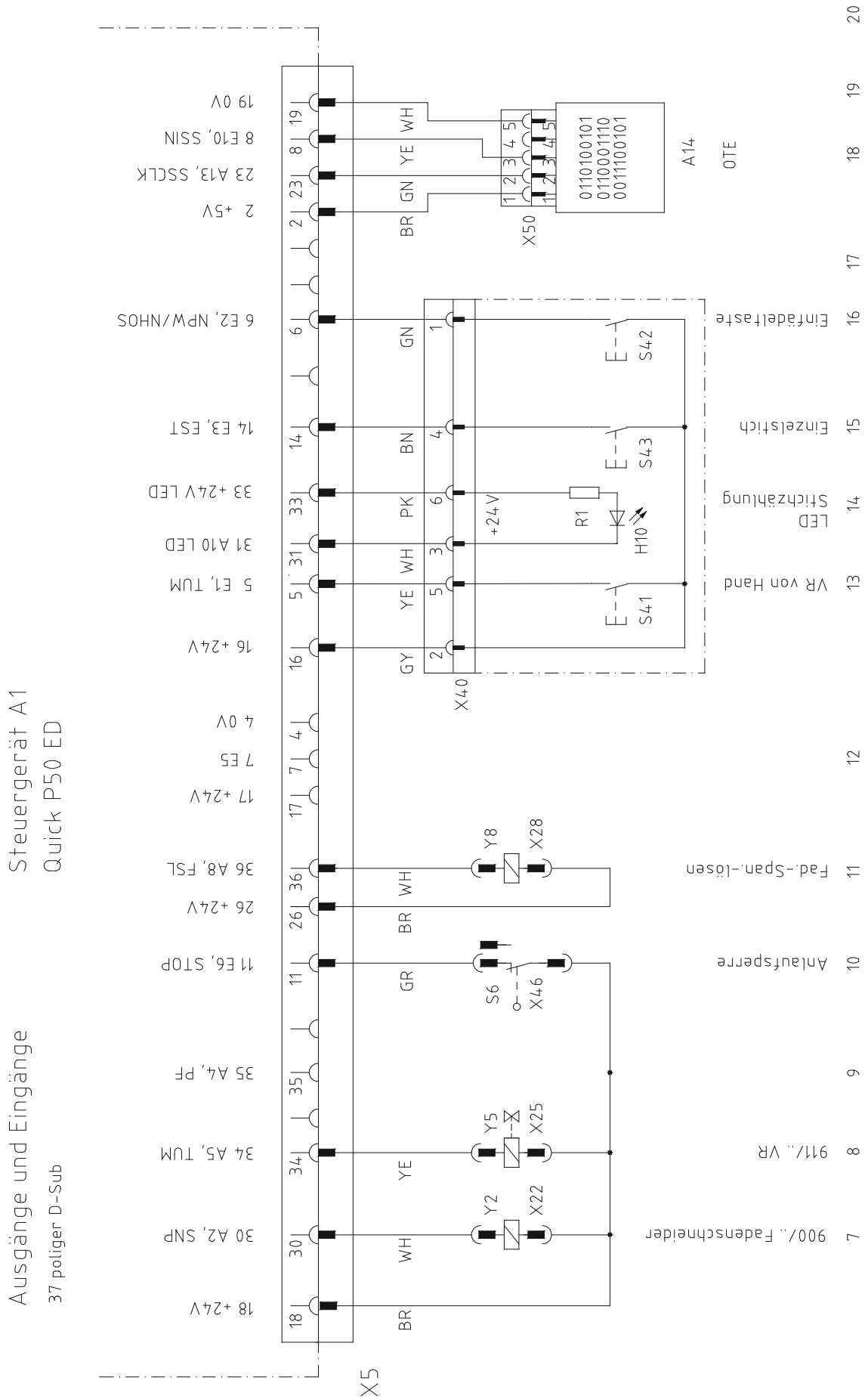

Steuergerät A1 Quick P50 ED

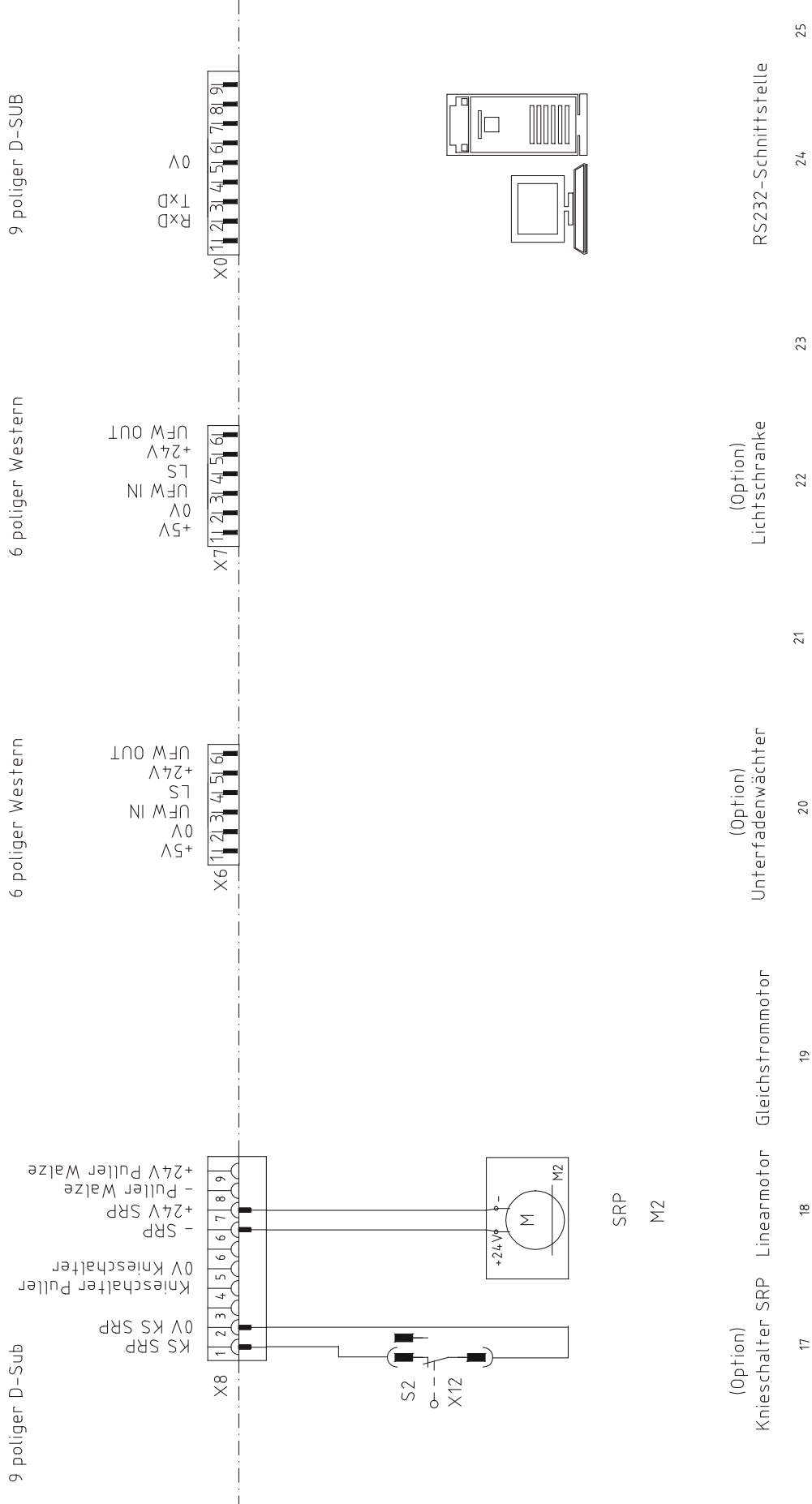

PFAFF

PFAFF Industrie Maschinen AG

Postfach 3020
D-67653 Kaiserslautern

Königstr. 154
D-67655 Kaiserslautern

Telefon: (0631) 200-0
Telefax: (0631) 17202
E-Mail: info@pfaff-industrial.com