



Union Special[®]
INDUSTRIAL SEWING EQUIPMENT

STYLES

ILLUSTRATED PARTS LIST

LIST OF SCREWS AND NUTS

**CATALOG
NO. 86N**

**FIRST
EDITION**

FIRST EDITION
© 1962

PRINTED 1996 IN USA

INFORMATION SUBJECT TO CHANGE WITHOUT NOTICE

© UNION SPECIAL CORPORATION ALL RIGHTS RESERVED IN ALL COUNTRIES.

Catalog No. 86 N

First Edition

LIST
OF
UNION SPECIAL
SCREWS AND NUTS

Copyright 1954-1962
by
Union Special Machine Co.
Rights Reserved in All Countries

Union Special
MACHINE COMPANY
INDUSTRIAL SEWING MACHINES
CHICAGO

Printed in U.S.A.

INTRODUCTION

In issuing this catalog, Union Special is prompted by a desire to assist the users of its machines in selecting the proper screws and nuts for use in Union Special machines. In this catalog will be found illustrations of the popular Union Special screws and nuts grouped by types, together with a numerical list of these parts. In addition to the numerical list, there will be found a classified list with the parts grouped by thread sizes.

NUMERICAL LIST

This is a complete list of all screws and nuts covered by this catalog. It is set up in ascending numerical order, regardless of type or size of part.

A brief description of the part is given covering the essential information, such as type of screw or nut, thread size, length and the corresponding tap. Obviously, it is impossible to list all the uses of each part, as many of them are used in several different places and on a great variety of machines.

CLASSIFIED LIST

This list is set up with the parts grouped according to thread sizes. These groups are subdivided by types and the types arranged according to length.

THREAD SIZE

The term "thread size", as used in this catalog, refers to the thread size of a screw or nut represented by the external diameter of the threaded portion and the number of thread per inch. It consists of a symbol which has two parts separated by a hyphen. The portion preceding the hyphen represents the external diameter of the screw and the portion following the hyphen represents the number of threads per inch. Example: ".182-40" signifies that the threaded portion of the part is .182 inch in diameter and the threads are 40 per inch. There are two distinct types of symbols used by Union Special to designate thread sizes.

(1) A symbol where the diameter is represented by a decimal figure. Example: ".182-40". These symbols represent exclusive Union Special threads.

(2) A symbol where the diameter is represented by a whole number or a fractional number. Example: "8-32" or "5/16-18". These symbols represent United States Standard threads.

Under each heading in the Classified List will be found a description of the thread size, together with the symbol under which the tap may be ordered. The number and diameter of the drill required for use with each tap are also given.

SCREW ASSORTMENTS

After a careful study of orders, several assortments of the most popular screws have been set up under part numbers 29484, 29484 S, 29484 T, 29484 U and 29484 V.

The assortments come packed in small parts cartons, and for convenience in handling, the headless screws are segregated from the others in separate removable compartments.

The prices of these assortments are considerably less than the cost of the screws if sold separately.

Part No. 29484 consists of an assortment of miscellaneous screws most generally used in servicing Union Special machines.

Part No. 29484 S consists of an assortment of miscellaneous screws frequently used in servicing Union Special machines.

Part No. 29484 T consists of an assortment of screws most generally used in servicing styles in Class 80600.

Part No. 29484 U consists of an assortment of screws most generally used in servicing Style 60000 D.

Part No. 29484 V consists of an assortment of screws most generally used in servicing styles in Class 14500.

The following listing shows the quantities and part numbers of the screws included in each assortment.

SCREW ASSORTMENTS (Continued)

<u>PART NO. 29484</u>		<u>PART NO. 29484 S</u>		<u>PART NO. 29484 T</u>		<u>PART NO. 29484 U</u>		<u>PART NO. 29484 V</u>	
<u>Quantity</u>	<u>Part No.</u>	<u>Quantity</u>	<u>Part No.</u>	<u>Quantity</u>	<u>Part No.</u>	<u>Quantity</u>	<u>Part No.</u>	<u>Quantity</u>	<u>Part No.</u>
(3)	25 B	(3)	25 B	(2)	HA61 D	(2)	HS24 C	(2)	72
	25 S		25 S		74 A		80		87 U
	25 CC		75 A		J79 J		82		141
	75 A		88 A		HA81		89		14076
	88 A		91		85		90		22569
	91		97		88 A		91 A		22597 A
	97		604		88 D		95		22794
	605		605		HA95		96		22823 A
	22525		605 A		97		98	(3)	25 S
(5)	25 C		22519 C		97 X		9663		25 CC
	28		22525		98		22516 A		73
	28 C		22570		BP108		22517 B		81
	73		22585 A		318		22542		88
	73 A		22585 B		376		22548		88 A
	77		22597 A		906		22560 A		90
	81		22738 C		906 A		22562		91
	87 U		22747		22515 A		22570 A		93
	88 B		22799 B		22560 A		22588 A		94
	89		22799 D		22564		22604		98 A
	90		22799 E		22570		22764		22524
	93		22799 F		22596		22795		22570
	93 A		22799 G		22597 A		22799 M		22592
	94		22799 H		22638 B		22837		22596
	95		22799 P		22707		22882		22768
	96		22834		22768	(3)	77	(4)	77
	98		22845 A		22852 A		88		
	98 A		22849 A		22874		93		
	187 A	(4)	25 CC		22874 C		376		
	376		28		92121		22528		
	605 A		28 C		92127		22562 A		
	22524		187 A		99248		22775		
	22561		376	(3)	C41				
	22574		22597		73				
	22597	(5)	25 C		81				
	22768		77		88				
(10)	80		87 U		93				
	87		88 B		96				
	88		89		96 A				
			93		22517				
			93 A		22894 C				
			95		22894 D				
			96	(4)	73 C				
			98		93 A				
			98 A		95				
			22574		22560 B				
			22894 C		22574				
			22894 D	(5)	80				
			22894 E		94				
			22894 F						
			22894 H						
			22894 J						
			22894 K						
		(6)	73						
			73 A						
			90						
			94						
			22524						
			22561						
			22768						
		(10)	80						
			87						
			88						

TERMS

Prices are strictly net cash and subject to change without notice. All shipments are forwarded f. o. b. shipping point. Parcel Post shipments are insured unless otherwise directed. A charge is made to cover postage and insurance.

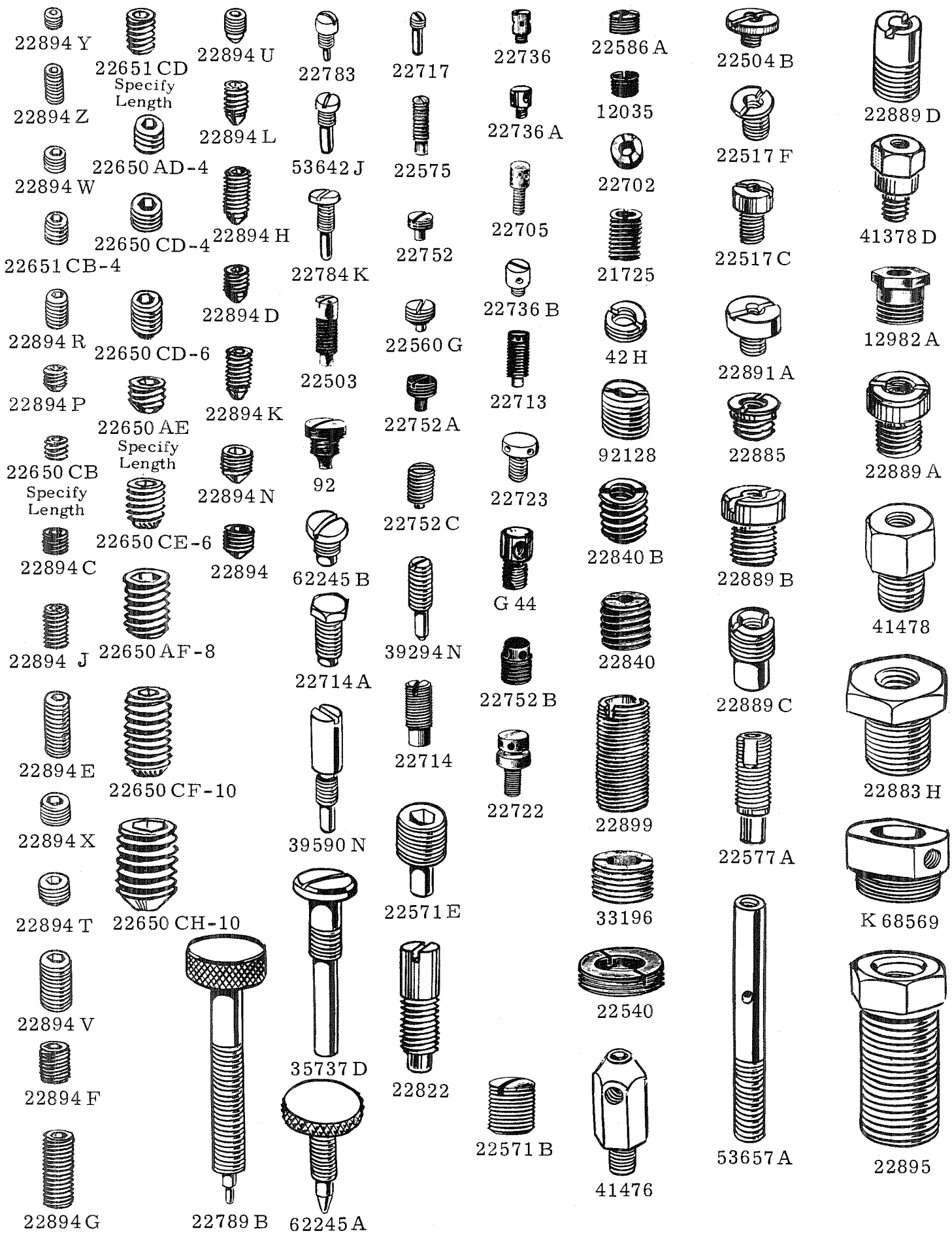

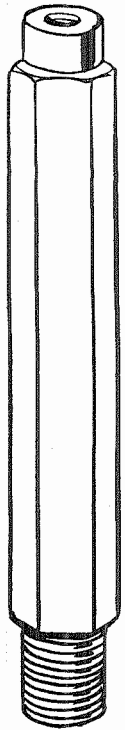

22841 E

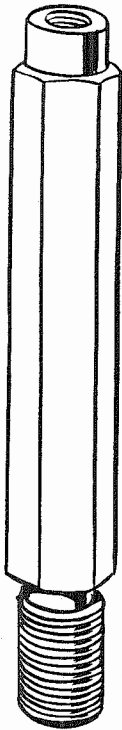

22841 B

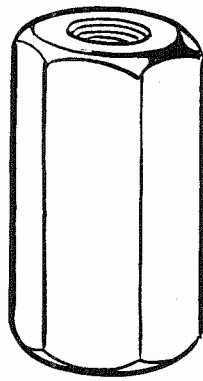

22841 F



22841 C



22841 A



15862 H

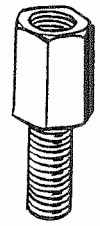

22841 H



51170 C



52782 C



52882 V

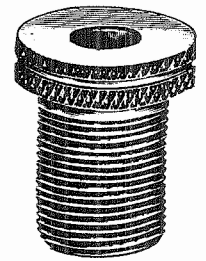

15476

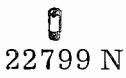

22799 N



22799 B



22799 S



15498 L



14



41274



53130 D



22701



22840 C



22837 B

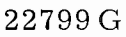

22799 G



22799 E



22799 J



HS 105 A



51080 A



22863



35833 F



22701



22840 C



22837 B

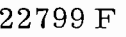

22799 F

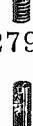

22799 E



22799 J



HS 105 A



14



22834



35833 F



22701



22840 C



22837 B

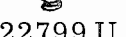

22799 U



22799 C



22799 J



HS 105 A



51080 A



22863 B



K 67428



22701



230



22837 B



22799 H



22799 C



22799 J



HS 105 A



51080 A



22863 B



K 67428



22701



230



22837 B



22799 A



22799 D



22799 J



22799 M

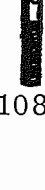

51080 A



51294 R



15447 A



12062 B



230



22837 B



22799 P



HS 65 P-4



22799 Q



22799 M



7489 P



35768 A



15447 A



38295



230



22837 B

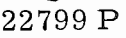

22799 R

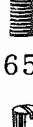

22799 L

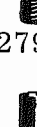

HS 100 D



22799 T



7489 P



22863 A



39295



38295



230



22837 B



22801



22799 L



HS 100 D



22799 T



7489 P



22863 A



39295



38295



230



22837 B

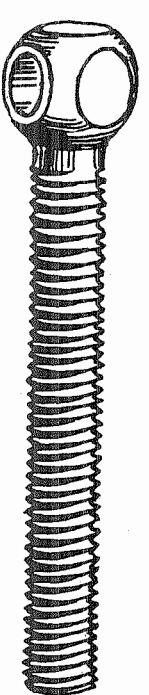

21697 M



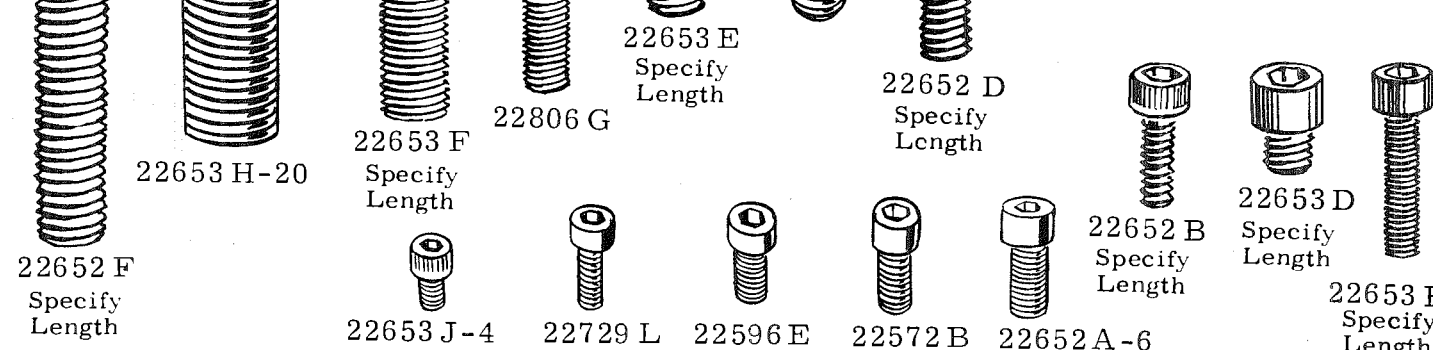
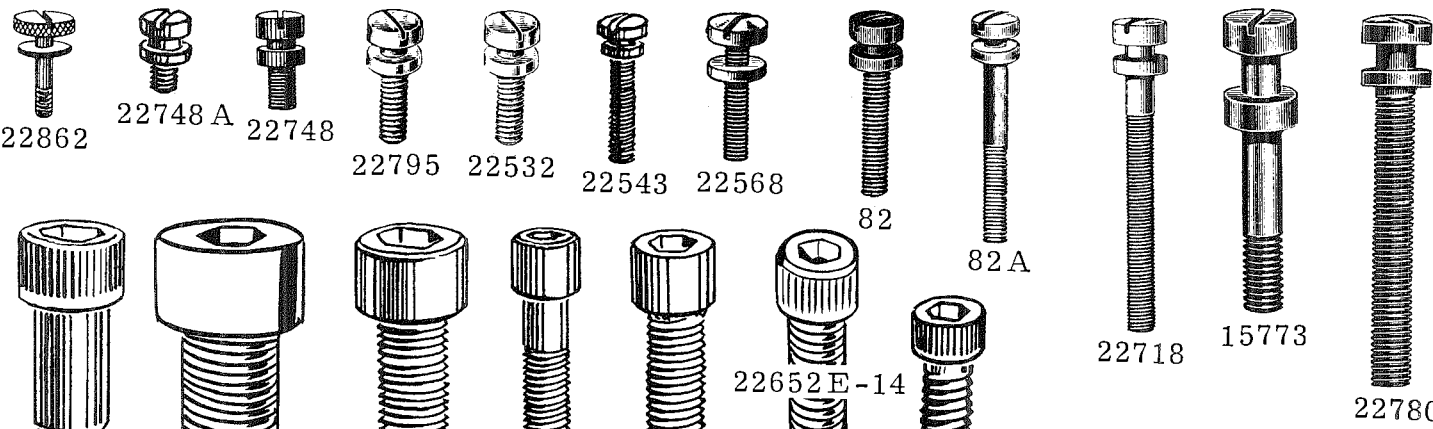
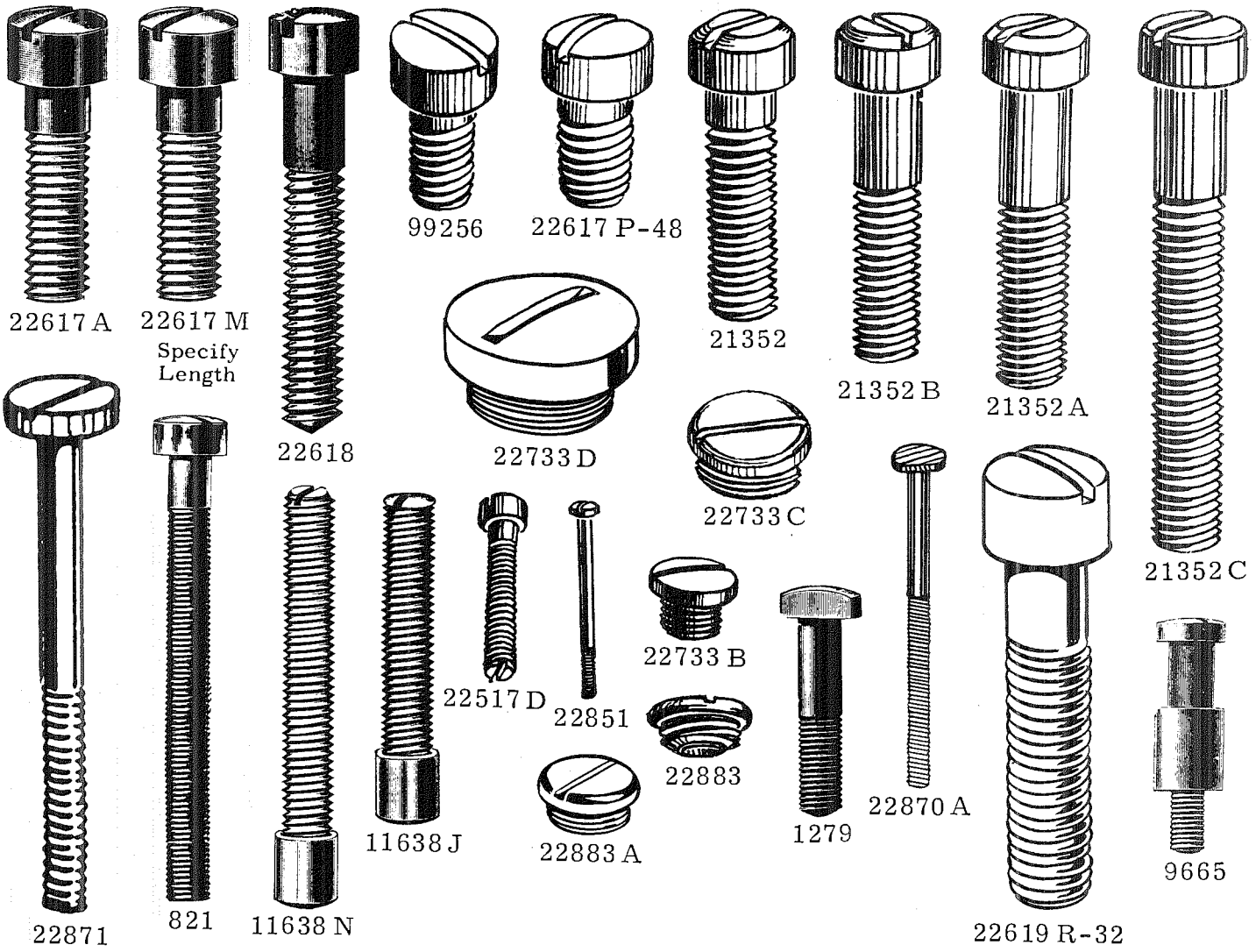

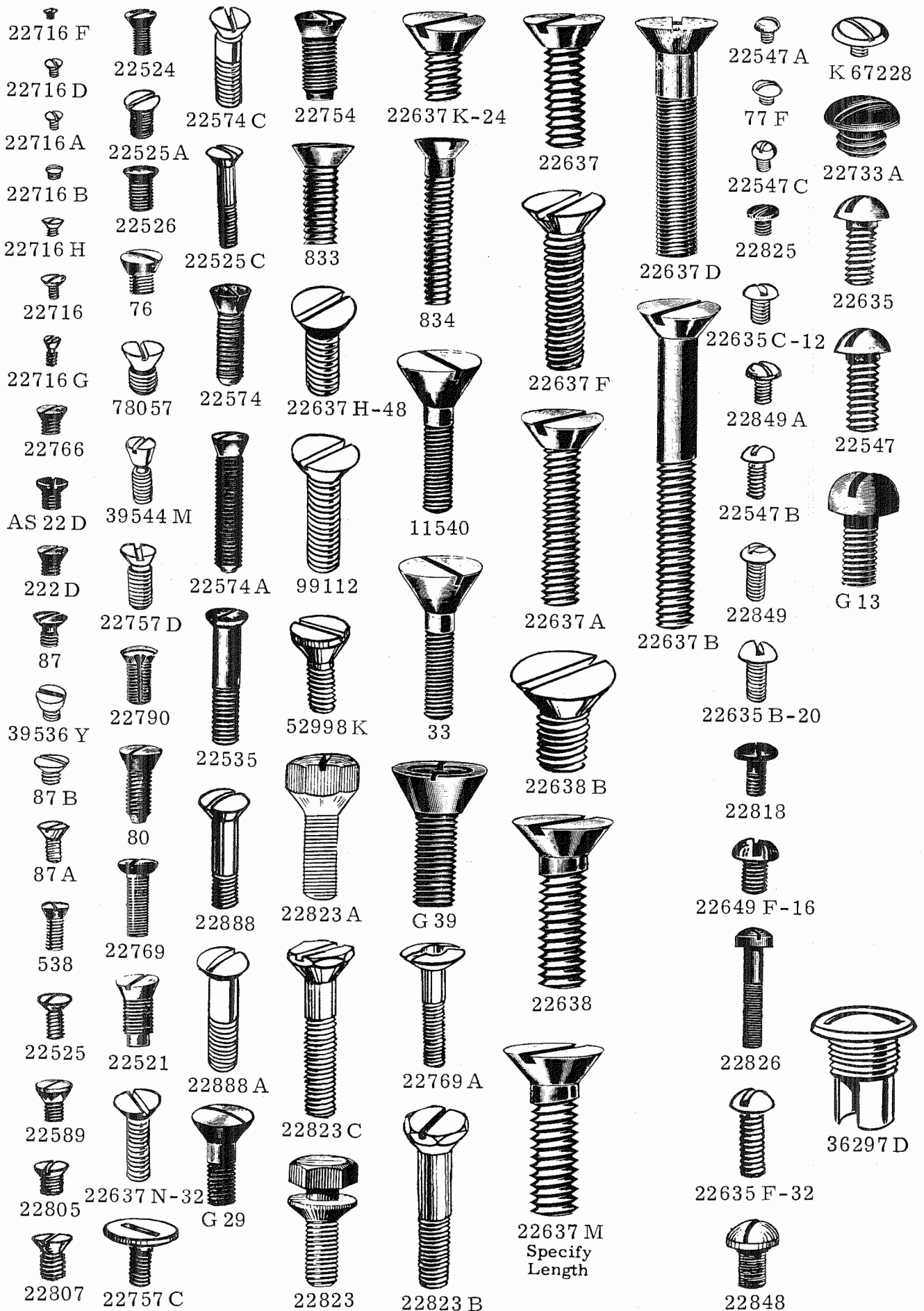





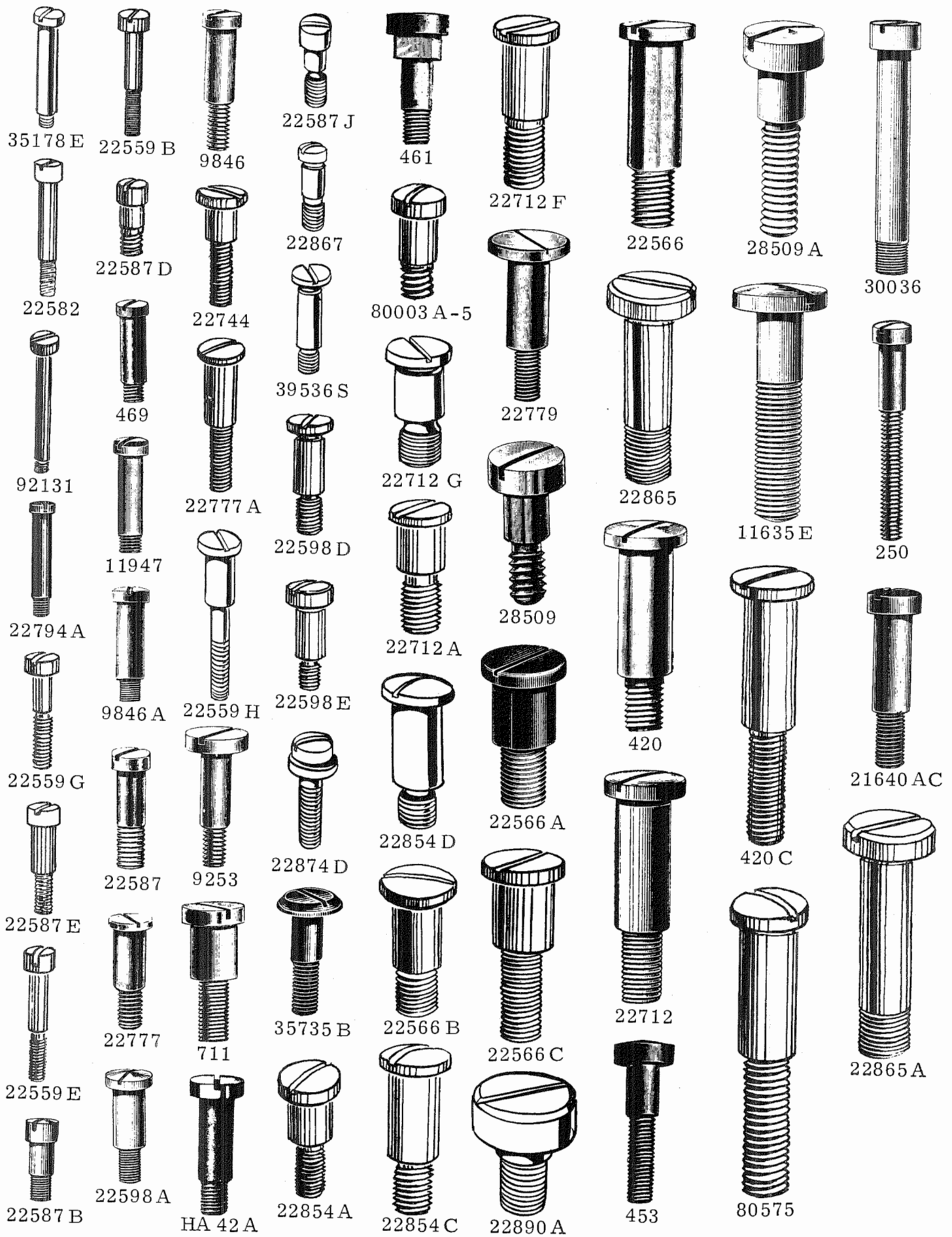

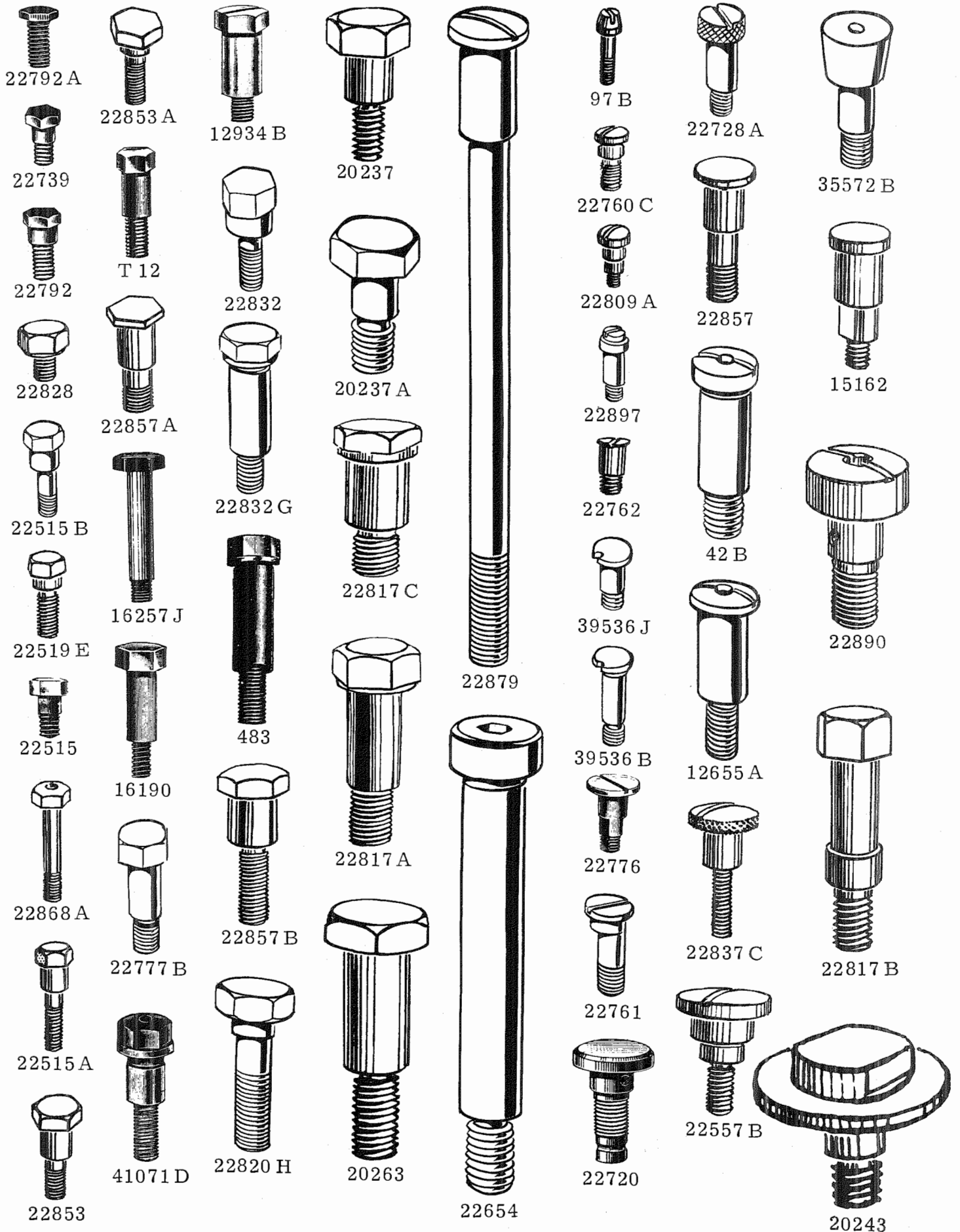

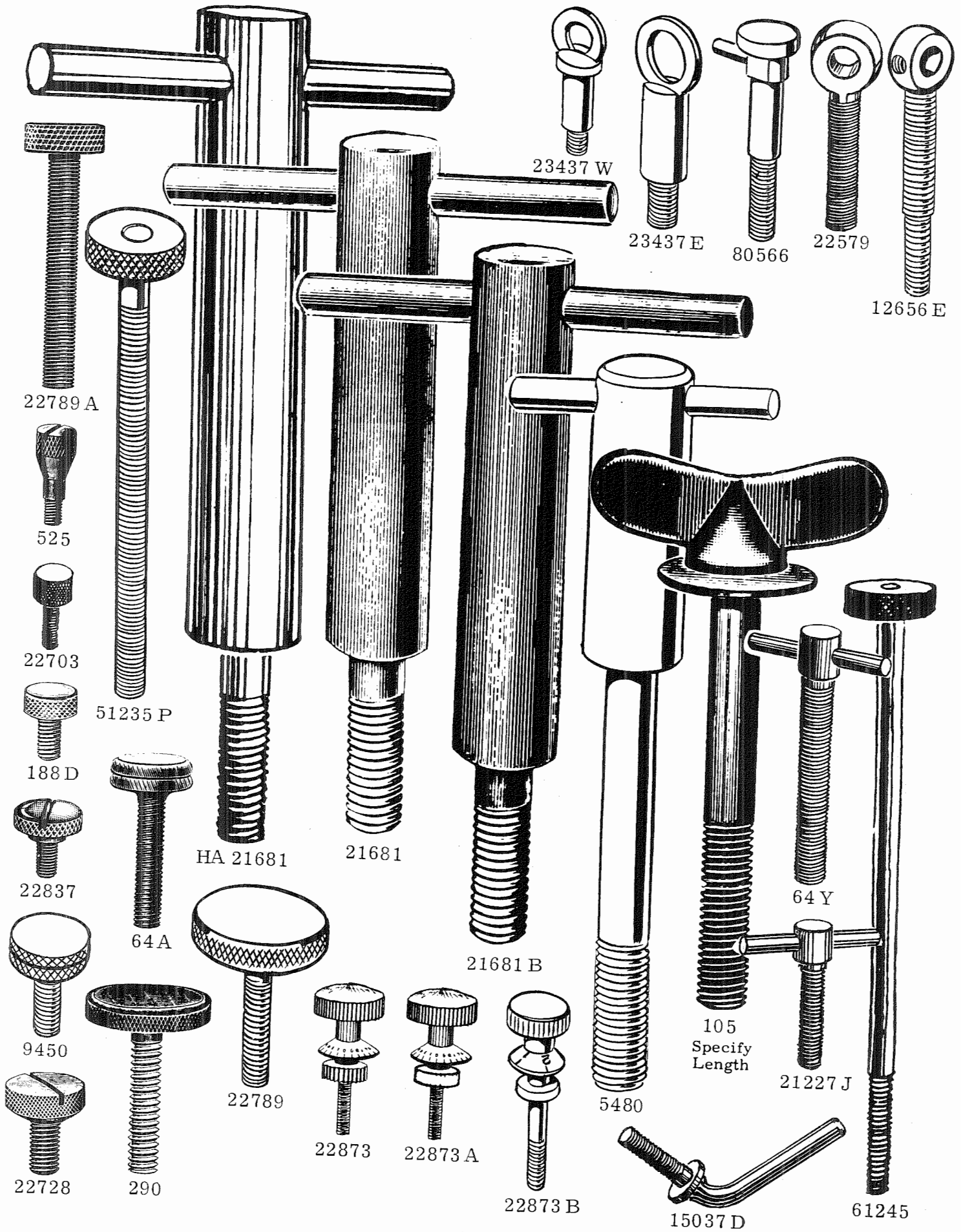





NUMERICAL LIST OF PARTS

<u>Part No.</u>	<u>Description</u>	<u>Page No.</u>
T2	Shoulder Screw, headless, 9/16 inch long, with 1/4 inch diameter shoulder 7/16 inch long, .182-40 thread, tap No. V109 -----	9
HT2 C	Screw, fillister head, 3/32 inch long, .124-50 thread, tap No. V104 -----	10
G3	Thumbscrew, knurled head, 1 1/32 inches long, No. 14-20 thread, tap No. V130 -----	20
T6	Nut, .415 inch diameter, fluted with 10 slots, 3/16 inch thick, .182-40 thread, tap No. V109 -----	21
G10	Thumbscrew, knurled head, 5/8 inch long, .146-40 thread, tap No. V107 --	20
T12	Shoulder Screw, hexagonal head, 45/64 inch long, with .250 inch diameter shoulder 3/8 inch long, .182-40 thread, tap No. V109 -----	18
G13	Cap Screw, round head, 5/8 inch long, 1/4-20 thread, tap No. V133 -----	13
14	Hinge Screw, headless, 1 13/16 inches long, with .192 inch diameter shoulder 1 1/2 inches long, .183-32 thread, tap No. V110 -----	8
T14	Cap Nut, hexagonal head, 27/64 inch thick, .182-40 thread, tap No. V109 --	20
G15	Nut, hexagonal, 5/16 inch thick, 5/16-18 thread, tap No. V134-----	21
17	Feed Crank Stud, 7/8 inch long, .214-32 thread, tap No. V113 -----	20
17 A	Feed Crank Stud, 7/8 inch long, .214-32 thread, tap No. V113 -----	20
17 B	Feed Crank Stud, 7/8 inch long, .214-32 thread, tap No. V113 -----	20
17 X	Feed Crank Stud, 7/8 inch long, .214-32 thread, tap No. V113 -----	20
HA17 A	Shoulder Screw, fillister head, 1 7/16 inches long, with 5/16 inch diameter shoulder 1/4 inch long, and .250 inch shoulder 21/32 inch long; .214-32 thread, tap No. V113 -----	20
HS17 B	Take-up Lever Stud, 49/64 inch long, with .250 inch diameter shoulder 29/64 inch long, .214-32 thread, tap No. V113 -----	20
18	Nut, hexagonal, 5/32 inch thick, .214-32 thread, tap No. V113 - -----	21
18 A	Nut, circular, knurled, 5/32 inch thick, .214-32 thread, tap No. V113-----	21
T18	Shoulder Screw, fillister head, 3/8 inch long, with .242 inch diameter shoulder 19/64 inch long, .182-40 thread, tap No. V109-----	16
HA18 A	Nut, hexagonal, 5/16 inch thick, .214-32 thread, tap No. V113-----	21
G20	Nut, circular, knurled, 1/2 inch thick, .548-18 thread, tap No. V125-----	21
22 KH	Screw, fillister head, 13/64 inch long, .124-50 thread, tap No. V104 -----	10
T22	Shoulder Screw, fillister head, 5/16 inch long, with .173 inch diameter shoulder 9/64 inch long, .124-50 thread, tap No. V104-----	16
AS22 D	Screw, countersunk head, 1/4 inch long, .146-40 thread, tap No. V107 ----	13
T23	Shoulder Screw, fillister head, 5/16 inch long, with .173 inch diameter shoulder 7/32 inch long, .124-50 thread, tap No. V104-----	16
C24	Thumbscrew, knurled head, 1/4 inch long, .214-32 thread, tap No. V113 --	20
HS24 C	Screw, fillister head, 5/32 inch long, .146-40 thread, tap No. V107 -----	10
25	Thumbscrew, knurled head, 3/8 inch long, No. 14-20 thread, tap No. V130 -----	20
25 B	Screw, fillister head, 1/8 inch long, .124-50 thread, tap No. V104 -----	10
25 C	Screw, fillister head, 9/32 inch long, No. 14-20 thread, tap No. V130 -----	10
25 S	Screw, fillister head, 9/32 inch long, .214-32 thread, tap No. V113 -----	10
25 T	Thumbscrew, knurled head, 11/64 inch long, .214-32 thread, tap No. V113 -----	20
25 U	Thumbscrew, knurled head, 31/64 inch long, No. 14-20 thread, tap No. V130 -----	20
25 CC	Screw, fillister head, 13/64 inch long, .182-40 thread, tap No. V109 -----	10
25 TB	Thumbscrew, knurled head, 13/32 inch long, .214-32 thread, tap No. V113 -----	20
AS25	Screw, fillister head, 41/64 inch long, 1/4-20 thread, tap No. V133 -----	11
G26	Thumbscrew, knurled head, 15/32 inch long, .146-40 thread, tap No. V107 -----	20
T26	Screw, fillister head, 7/64 inch long, .124-50 thread, tap No. V104 -----	10
28	Screw, fillister head, 5/32 inch long, .124-50 thread, tap No. V104 -----	10
28 A	Screw, headless, 1/16 inch long, .124-50 thread, tap No. V104 -----	6
28 B	Screw, headless, 3/32 inch long, .124-50 thread, tap No. V104 -----	6
28 C	Screw, headless, 1/8 inch long, .124-50 thread, tap No. V104 -----	6
G29	Screw, countersunk head, 5/8 inch long, .219-28 thread, tap No. V116 ----	13
T29	Nut, circular, knurled, 29/64 inch thick, .182-40 thread, tap No. V109----	21
T32	Screw, fillister head, 13/16 inch long, 5/16-18 thread, tap No. V134 -----	11

NUMERICAL LIST OF PARTS

<u>Part No.</u>	<u>Description</u>	<u>Page No.</u>
33	Screw, countersunk head, 1 3/16 inches long, .219-28 thread, tap No. V116 -----	13
34	Nut, hexagonal, 5/32 inch thick, .219-28 thread, tap No. V116-----	21
37 L	Nut, hexagonal, 1/8 inch thick, .183-32 left thread, tap No. V111-----	21
37 R	Nut, hexagonal, 1/8 inch thick, .183-32 thread, tap No. V110-----	21
C38	Shoulder Screw, fillister head, 19/32 inch long, with .318 inch diameter shoulder .148 inch long, .214-32 thread, tap No. V113-----	16
T38	Screw, hexagonal head, 11/16 inch long, .182-40 thread, tap No. V109 ----	14
G39	Screw, countersunk head, 1 inch long, .314-24 thread, tap No. V119 -----	13
T40	Screw, fillister head, 1 7/32 inches long, .182-40 thread, tap No. V109 ---	11
C41	Shoulder Screw, fillister head, 35/64 inch long, with .219 inch diameter shoulder 13/32 inch long, .182-40 thread, tap No. V109-----	16
42 A	Shoulder Screw, headless, 11/16 inch long, with .250 inch diameter shoulder, 7/16 inch long, .182-40 thread, tap No. V109-----	9
42 B	Shoulder Screw, fillister head, 1 7/16 inch long, with .406 inch diameter shoulder 59/64 inch long, 5/16-18 thread, tap No. V134-----	18
42 H	Nut, circular, 1/8 inch thick, .183-32 thread, tap No. V110-----	7
G42	Thumbscrew, 15/32 inch long, .257-32 thread, tap No. V118 -----	20
J42 JK	Shoulder Screw, headless, 47/64 inch long, with .210 inch diameter shoulder 19/64 inch long, .182-40 thread, tap No. V109-----	9
HA42	Shoulder Screw, headless, 59/64 inch long, with .275 inch diameter shoulder 19/32 inch long, .214-32 thread, tap No. V113-----	9
HA42 A	Shoulder Screw, fillister head, 59/64 inch long, with .269 inch diameter shoulder 5/8 inch long, .214-32 thread, tap No. V113-----	17
G44	Screw, capstan head, 1/4 inch long, .182-40 thread, tap No. V109 -----	7
47	Nut, hexagonal, 5/16 inch thick, .414-16 thread, tap No. V123-----	21
C49	Shoulder Screw, fillister head, 19/32 inch long, with .346 inch diameter shoulder 9/32 inch long, .214-32 thread, tap No. V113-----	16
56	Nut, hexagonal, 7/32 inch thick, 36V taper thread -----	21
HA56	Nut, hexagonal, 9/32 inch thick, 36V taper thread -----	21
57 WD	Shoulder Screw, fillister head, 17/64 inch long, with .171 inch diameter shoulder 5/32 inch long, .124-50 thread, tap No. V104-----	16
G57 A	Nut, hexagonal, 3/8 inch thick, .368-24 thread, tap No. V119 A-----	21
HA61 D	Screw, fillister head, 5/16 inch long, .214-32 thread, tap No. V113 -----	11
64 A	Thumbscrew, knurled head, 1 7/64 inches long, .219-28 thread, tap No. V116 -----	19
64 B	Nut, circular, knurled, 1/4 inch thick, .219-28 thread, tap No. V116-----	21
64 Y	Thumbscrew, 2 1/4 inches long, .257-32 thread, tap No. V118-----	19
HA65 E	Shoulder Screw, fillister head, 29/64 inch long, with .199 inch diameter shoulder 19/64 inch long, .182-40 thread, tap No. V109-----	16
HA65 L	Shoulder Screw, fillister head, 5/16 inch long, with .199 inch diameter shoulder 7/32 inch long, .182-40 thread, tap No. V109-----	16
HS65 O	Shoulder Screw, fillister head, 13/32 inch long, with .197 inch diameter shoulder 7/32 inch long, .182-40 thread, tap No. V109-----	16
HS65 P-4	Hinge Screw, headless, 13/32 inch long, with .147 inch diameter shoulder 1/4 inch long, .146-40 thread, tap No. V107-----	8
69 FD	Set Screw, square head, cup point, 5/8 inch long, 5/16-18 thread, tap No. V134 -----	15
72	Screw, fillister head, 15/64 inch long, .183-32 thread, tap No. V110 -----	11
73	Screw, fillister head, 3/16 inch long, .183-32 thread, tap No. V110 -----	11
73 A	Screw, fillister head, 9/64 inch long, .088-64 thread, tap No. V100 -----	10
73 C	Set Screw, headless, 15/64 inch long, .124-50 thread, tap No. V104-----	6
73 X	Set Screw, fillister head, 3/16 inch long, .183-32 thread, tap No. V110----	10
73 XA	Screw, fillister head, cup point, 5/32 inch long, .183-32 thread, tap No. V110 -----	11
HA73 B	Set Screw, headless, 5/32 inch long, .124-50 thread, tap No. V104-----	6
74	Screw, fillister head, 25/32 inch long, .214-32 thread, tap No. V113 -----	11
74 A	Screw, hexagonal head, 13/16 inch long, .257-32 thread, tap No. V118 ----	14
74 E	Screw, headless, 9/32 inch long, .257-32 thread, tap No. V118-----	6
75	Screw, fillister head, 19/32 inch long, .155-40 thread, tap No. V108 ----	11
75 A	Shoulder Screw, fillister head, 23/32 inch long, with .162 inch diameter shoulder 11/32 inch long, .155-40 thread, tap No. V108-----	13

NUMERICAL LIST OF PARTS

<u>Part No.</u>	<u>Description</u>	<u>Page No.</u>
75 C	Screw, fillister head, 7/16 inch long, .155-40 thread, tap No. V108 -----	10
76	Screw, countersunk head, 1/4 inch long, .214-32 thread, tap No. V113-----	13
77	Screw, fillister head, 3/16 inch long, .124-50 thread, tap No. V104 -----	11
77 A	Screw, fillister head, 5/32 inch long, .124-50 thread, tap No. V104 -----	11
77 B	Screw, fillister head, 21/64 inch long, .124-50 thread, tap No. V104 -----	11
77 F	Screw, round head, 1/8 inch long, .124-50 thread, tap No. V104 -----	13
77 N	Screw, fillister head, 3/16 inch long, .124-50 thread, tap No. V104 -----	10
77 P	Screw, fillister head, 5/32 inch long, .124-50 thread, tap No. V104 -----	10
77 Q	Set Screw, headless, 23/64 inch long, .124-50 thread, tap No. V104 -----	6
78	Set Screw, headless, 5/32 inch long, .182-40 thread, tap No. V109 -----	6
79	Screw, fillister head, 11/32 inch long, .183-32 thread, tap No. V110 -----	11
J79 J	Screw, fillister head, 27/64 inch long, .183-32 thread, tap No. V110 -----	11
80	Screw, countersunk head, 33/64 inch long, .214-32 thread, tap No. V113----	13
81	Spot Screw, headless, 25/64 inch long, .214-32 thread, tap No. V113 -----	6
HA81	Spot Screw, headless, 29/64 inch long, .257-32 thread, tap No. V118 -----	6
82	Screw, fillister head, 47/64 inch long, under flange, .146-40 thread, tap No. V107 -----	12
82 A	Screw, fillister head, 15/16 inch long, under flange, .146-40 thread, tap No. V107-----	12
HS82	Screw, headless, 27/32 inch long, .146-40 thread, tap No. V107 -----	6
85	Screw, fillister head, 29/32 inch long, .191-28 thread, tap No. V112 -----	11
86	Shoulder Screw, fillister head, 19/64 inch long, with .219 inch diameter shoulder 9/64 inch long, .182-40 thread, tap No. V109 -----	16
86 A	Shoulder Screw, fillister head, 19/64 inch long, with .220 inch diameter shoulder 9/64 inch long, .214-32 thread, tap No. V113 -----	16
86 X	Shoulder Screw, fillister head, 7/16 inch long, with .180 inch diameter shoulder 19/64 inch long, .146-40 thread, tap No. V107 -----	16
HA86 A	Shoulder Screw, fillister head, 17/32 inch long, with .319 inch diameter shoulder 17/64 inch long, .257-32 thread, tap No. V118 -----	16
87	Screw, countersunk head, 1/4 inch long, .146-40 thread, tap No. V107-----	13
87 A	Screw, countersunk head, 19/64 inch long, .146-40 thread, tap No. V107----	13
87 B	Screw, countersunk head, 13/64 inch long, .146-40 thread, tap No. V107----	13
87 U	Screw, fillister head, 3/16 inch long, .124-50 thread, tap No. V104 -----	10
J87 J	Screw, fillister head, 9/32 inch long, .124-50 thread, tap No. V104 -----	10
88	Screw, headless, 5/32 inch long, .182-40 thread, tap No. V109 -----	6
88 A	Screw, fillister head, 5/32 inch long, .182-40 thread, tap No. V109 -----	10
88 B	Set Screw, headless, 9/64 inch long, .182-40 thread, tap No. V109 -----	6
88 D	Screw, fillister head, 5/16 inch long, .182-40 thread, tap No. V109 -----	10
88 F	Screw, fillister head, 23/32 inch long, .182-40 thread, tap No. V109 -----	11
89	Set Screw, headless, 3/16 inch long, .182-40 thread, tap No. V109 -----	6
90	Screw, fillister head, 7/32 inch long, .146-40 thread, tap No. V107 -----	10
91	Screw, fillister head, 15/64 inch long, .146-40 thread, tap No. V107 -----	11
91 A	Screw, fillister head, 3/32 inch long, .110-50 thread, tap No. V102 -----	10
91 D	Screw, fillister head, 19/64 inch long, .146-40 thread, tap No. V107 -----	11
92	Screw, fillister head, 9/32 inch long, .214-32 thread, tap No. V113 -----	7
92 A	Screw, fillister head, 9/64 inch long, .214-32 thread, tap No. V113 -----	10
93	Screw, fillister head, 7/16 inch long, .182-40 thread, tap No. V109 -----	10
93 A	Screw, fillister head, 9/32 inch long, .182-40 thread, tap No. V109 -----	10
94	Screw, fillister head, 1/4 inch long, .182-40 thread, tap No. V109-----	10
95	Set Screw, headless, 15/64 inch long, .214-32 thread, tap No. V113 -----	6
HA95	Set Screw, headless, 3/8 inch long, .257-32 thread, tap No. V118 -----	6
96	Spot Screw, headless, 17/64 inch long, .214-32 thread, tap No. V113 -----	6
96 A	Spot Screw, headless, 5/16 inch long, .214-32 thread, tap No. V113 -----	6
97	Screw, fillister head, 11/32 inch long, .146-40 thread, tap No. V107 -----	11
97 A	Shoulder Screw, fillister head, 29/64 inch long, with .156 inch diameter shoulder 7/32 inch long, .146-40 thread, tap No. V107 -----	16
97 B	Shoulder Screw, beveled head, 29/64 inch long, with .156 inch diameter shoulder 7/32 inch long, .146-40 thread, tap No. V107 -----	18
97 X	Screw, fillister head, 15/64 inch long, .146-40 thread, tap No. V107 -----	11
98	Set Screw, headless, 13/64 inch long, .214-32 thread, tap No. V113 -----	6
98 A	Screw, fillister head, 1/4 inch long, .126-40 thread, tap No. V105 -----	10

NUMERICAL LIST OF PARTS

<u>Part No.</u>	<u>Description</u>	<u>Page No.</u>
HS100 D	Shoulder Screw, headless, 45/64 inch long, with .156 inch diameter shoulder 19/32 inch long, .146-40 thread, tap No. V107 -----	8
105-1 1/2	Table Screw, 1 1/2 inches long, .404-16 thread, tap No. V122 -----	19
105-2 1/2	Table Screw, 2 1/2 inches long-----	19
105-3	Table Screw, 3 inches long-----	19
105-3 1/2	Table Screw, 3 1/2 inches long-----	19
105-4	Table Screw, 4 inches long-----	19
105-4 1/2	Table Screw, 4 1/2 inches long-----	19
105-5	Table Screw, 5 inches long-----	19
105-5 1/2	Table Screw, 5 1/2 inches long-----	19
105-6	Table Screw, 6 inches long-----	19
HS105 A	Screw Pin, headless, 1 23/64 inches long, with .199 inch diameter shoulder 1 5/32 inches long, .155-40 thread, tap No. V108 -----	8
108	Nut, circular, knurled, 5/16 inch thick, .224-32 thread, tap No. V117--	21
108 C	Nut, circular, knurled, chromium plated, 5/16 inch thick, .224-32 thread, tap No. V117-----	21
BP108	Screw, hexagonal head, 35/64 inch long, .257-32 thread, tap No. V118--	14
119 A	Shoulder Screw, fillister head, 35/64 inch long, with .304 inch diameter shoulder .207 inch long, No. 14-20 thread, tap No. V130 ----	16
128 D-1	Screw, countersunk head, 1 3/8 inches long, with .257 inch diameter shoulder, 21/32 inch long, threaded end slotted, .214-32 thread, tap No. V113-----	9
134	Shoulder Screw, fillister head, 5/32 inch long, with .219 inch diameter shoulder, .065 inch long, .182-40 thread, tap No. V109 -----	16
136	Screw, fillister head, 21/32 inch long, .214-32 thread, tap No. V113 ---	11
138	Screw, fillister head, 9/64 inch long, .126-40 thread, tap No. V105 ----	10
141	Screw, fillister head, 17/32 inch long, .214-32 thread, tap No. V113 ---	10
150	Screw, fillister head, 3/32 inch long, .124-50 thread, tap No. V104 ----	11
157	Screw, hexagonal head, 1 7/64 inches long, .257-32 thread, tap No. V118-----	14
166	Screw, hexagonal head, 5/32 inch long, .182-40 thread, tap No. V109---	14
187 A	Screw, fillister head, 7/64 inch long, .124-50 thread, tap No. V104 ----	10
187 B	Screw, fillister head, 5/64 inch long, .124-50 thread, tap No. V104 ----	10
188 D	Thumbscrew, knurled head, 5/16 inch long, .182-40 thread, tap No. V109-----	19
201 C	Thumbscrew, knurled head, 39/64 inch long, No. 14-20 thread, tap No. V130-----	20
222 D	Screw, countersunk head, 11/64 inch long, .146-40 thread, tap No. V107-----	13
223 C	Shoulder Screw, fillister head, 5/32 inch long, with .141 inch diameter shoulder .085 inch long, .124-50 thread, tap No. V104 -----	16
226	Shoulder Screw, fillister head, 7/64 inch long, with .137 inch diameter shoulder, 1/32 inch long, .110-50 thread, tap No. V102 ----	16
230	Screw, headless, 15/32 inch long, .182-40 thread, tap No. V109 -----	8
236	Shoulder Screw, fillister head, 51/64 inch long, with .375 inch diameter shoulder 27/64 inch long, .214-32 thread, tap No. V113 ----	16
240	Shoulder Screw, fillister head, 5/16 inch long, with .219 inch diameter shoulder 9/64 inch long, .182-40 thread, tap No. V109 -----	16
248	Screw Pin, headless, 1 1/2 inches long, with .139 inch diameter pilot 1 1/8 inches long, .191-28 thread, tap No. V112 -----	9
249	Nut, hexagonal, 9/64 inch thick, .191-28 thread, tap No. V112 -----	21
250	Screw, fillister head, 1 19/32 inches long, .191-28 thread, tap No. V112-----	17
250 A	Screw, fillister head, 1 9/16 inches long, .191-28 thread, tap No. V112-	11
255	Screw, fillister head, 13/64 inch long, .182-40 thread, tap No. V109 ---	10
257	Shoulder Screw, fillister head, 1 3/16 inch long, with .375 inch diameter shoulder 3/8 inch long, .257-32 thread, tap No. V118 -----	16
258	Nut, hexagonal, 11/64 inch thick, .257-32 thread, tap No. V118-----	21
258 A	Nut, hexagonal, 1/8 inch thick, .257-32 thread, tap No. V118-----	21
269	Nut, hexagonal, 5/32 inch thick, .217-32 left thread, tap No. V114 ----	21
290	Thumbscrew, knurled head, 1 1/32 inches long, No. 14-20 thread, tap No. V130-----	19

NUMERICAL LIST OF PARTS

Part No.	<u>Description</u>	Page No.
294	Screw, fillister head, 15/16 inch long, .183-32 thread, tap No. V110-----	11
303	Screw, hexagonal head, 13/32 inch long, .182-40 thread, tap No. V109 -----	14
318	Screw, fillister head, 25/32 inch long, .257-32 thread, tap No. V118-----	11
357	Screw, fillister head, 1/8 inch long, .146-40 thread, tap No. V107-----	10
375	Nut, hexagonal, 1/8 inch thick, .255-40 thread, tap No. V92 -----	21
376	Screw, fillister head, 9/32 inch long, .182-40 thread, tap No. V109-----	10
376 A	Screw, fillister head, 11/32 inch long, .182-40 thread, tap No. V109-----	10
377	Nut, circular, slotted, 3/32 inch thick, .182-40 thread, tap No. V109 -----	21
402	Shoulder Screw, headless, 13/32 inch long, with 1/4 inch diameter shoulder, 1/4 inch long, .182-40 thread, tap No. V109 -----	9
407	Screw, fillister head, 5/64 inch long, .146-40 thread, tap No. V107-----	10
407 A	Screw, fillister head, 5/64 inch long, .124-50 thread, tap No. V104-----	10
420	Shoulder Screw, fillister head, 1 35/64 inches long, with .437 inch diameter shoulder 1 1/16 inches long, .314-24 thread, tap No. V119 -----	17
420 B	Nut, hexagonal, 1/4 inch thick, .314-24 thread, tap No. V119 -----	21
420 C	Shoulder Screw, fillister head, 2 3/16 inches long, with .437 inch diameter shoulder 1 1/64 inches long, .314-24 thread, tap No. V119 -----	17
433	Nut, circular, knurled, 25/64 inch thick, .224-32 thread, tap No. V117 -----	21
434	Nut, circular, knurled, 1/4 inch thick, .224-32 thread, tap No. V117 -----	21
453	Shoulder Screw, fillister head, 1 3/32 inches long, with .250 inch diameter shoulder 13/32 inch long, .214-32 thread, tap No. V113-----	17
461	Shoulder Screw, fillister head, 57/64 inch long, with flattened section, under head, and .250 inch diameter shoulder 13/32 inch long, .214-30 thread, tap No. V113-----	17
469	Shoulder Screw, fillister head, 47/64 inch long, with .199 inch diameter shoulder 19/32 inch long, .182-40 thread, tap No. V109 -----	17
479	Nut, circular, 5/32 inch thick, .182-40 thread, tap No. V109-----	21
483	Shoulder Screw, hexagonal head, 1 9/32 inches long, with .319 inch diameter shoulder 3/4 inch long, .214-32 thread, tap No. V113-----	18
525	Bolt Knob, knurled, 3/4 inch long, .146-40 thread, tap No. V107 -----	19
531	Screw, headless, 17/64 inch long, .182-40 thread, tap No. V109-----	6
538	Screw, countersunk head, 21/64 inch long, .146-40 thread, tap No. V107 -----	13
562	Screw, headless, 1 7/8 inches long over-all, with pilot 1 5/16 inches long, .257-32 thread, tap No. V118 -----	9
604	Screw, fillister head, 9/64 inch long, .110-50 thread, tap No. V102-----	10
605	Screw, fillister head, 5/32 inch long, .110-50 thread, tap No. V102-----	10
605 A	Screw, fillister head, 7/32 inch long, .110-50 thread, tap No. V102-----	10
627	Screw, hexagonal head, 19/32 inch long, .214-32 thread, tap No. V113 -----	14
627 A	Screw, hexagonal head, 13/16 inch long, .214-32 thread, tap No. V113 -----	14
641 C	Shoulder Screw, fillister head, 13/32 inch long, with .250 inch diameter shoulder 3/16 inch long, .219-28 thread, tap No. V116 -----	16
711	Shoulder Screw, fillister head, 7/8 inch long, with .375 inch diameter shoulder 29/64 inch long, .214-32 thread, tap No. V113 -----	17
713	Shoulder Screw, fillister head, 23/32 inch long, with .161 inch diameter shoulder 15/64 inch long, .155-40 thread, tap No. V108 -----	16
714	Nut, hexagonal, 5/32 inch thick, slotted, .155-40 thread, tap No. V108-----	21
719	Screw, headless, 31/64 inch long, .182-40 thread, tap No. V109-----	6
772	Spot Screw, headless, 13/16 inch long, .257-32 thread, tap No. V118 -----	6
816	Screw, fillister head, 11/16 inch long, .214-32 thread, tap No. V113-----	10
820	Screw, fillister head, 1 1/16 inches long, .257-32 thread, tap No. V118 -----	11
821	Screw, fillister head, 2 11/16 inches long, .257-32 thread, tap No. V118 -----	12
833	Screw, countersunk head, 23/32 inch long, No. 14-20 thread, tap No. V130 ---	13
834	Screw, countersunk head, 1 1/4 inches long, No. 14-20 thread, tap No. V130-----	13
897 D	Screw, fillister head, 11/16 inch long, .214-32 thread, tap No. V113-----	10
906	Screw, hexagonal head, 31/64 inch long, .155-40 thread, tap No. V108 -----	14
906 A	Screw, hexagonal head, 5/8 inch long, .155-40 thread, tap No. V108 -----	14
907	Nut, hexagonal, 3/32 inch thick, .155-40 thread, tap No. V108 -----	21
1025 L	Screw, headless, 3/16 inch long, 7/32-32 thread, tap No. V244-----	6
1032	Nut, circular, 5/16 inch thick, .214-32 thread, tap No. V113 -----	20
1059	Screw, headless, 5/64 inch long, .088-64 thread, tap No. V100-----	6
1059 A	Screw, fillister head, 7/64 inch long, .124-50 thread, tap No. V104-----	10

NUMERICAL LIST OF PARTS

<u>Part No.</u>	<u>Description</u>	<u>Page No.</u>
1096	Set Screw, headless, 3/32 inch long, .088-64 thread, tap No. V100 -----	6
1096 B	Set Screw, headless, 9/64 inch long, .088-64 thread, tap No. V100 -----	6
1279	Screw, fillister head, 1 3/16 inches long, .257-32 thread, tap No. V118-----	12
1280	Nut, hexagonal, 15/64 inch thick, .257-32 thread, tap No. V118 -----	21
1332	Shoulder Screw, headless, 13/16 inch long, with .248 inch diameter shoulder 9/16 inch long, .182-40 thread, tap No. V109 -----	9
1347 A	Nut, circular, knurled, 9/32 inch thick, .214-32 thread, tap No. V113 -----	21
2397 A	Nut, hexagonal, 5/32 inch thick, .214-32 thread, tap No. V113 -----	21
3341	Shoulder Screw, fillister head, 33/64 inch long, with .226 inch diameter shoulder 1/4 inch long, .182-40 thread, tap No. V109 -----	16
4573	Screw, headless, 39/64 inch long, .146-40 thread, tap No. V107 -----	6
4937	Shoulder Screw, fillister head, 9/16 inch long, with .257 inch diameter shoulder 5/16 inch long, .191-28 thread, tap No. V112 -----	16
4954	Nut, circular, slotted, 7/64 inch thick, No. 8-32 thread, tap No. V129-----	21
5144	Nut, hexagonal, slotted, 9/32 inch thick, .182-40 thread, tap No. V109 -----	21
5480	Machine Clamp Screw, 5 3/4 inches long over-all, .404-16 thread, tap No. V122-----	19
6042	Shoulder Stud, square head, 1 3/16 inches long, 11/16 inch of thread, .257-32 thread, tap No. V118-----	20
6091	Nut, hexagonal, 1/4 inch thick, .869-20 thread, tap No. V97 -----	21
6091 A	Nut, circular, knurled, 15/64 inch thick, .994-20 thread, tap No. V98 --	21
6939	Shoulder Stud, square head, 1 5/16 inches long, 11/16 inch of thread, .257-32 thread, tap No. V118-----	20
6948 D	Shoulder Screw, headless, 11/16 inch long, with 1/4 inch diameter shoulder 11/32 inch long, .155-40 thread, tap No. V108-----	9
6956 D	Nut, castellated, 5/32 inch thick, .155-40 thread, tap No. V108 -----	21
7489 P	Shoulder Screw, headless, 63/64 inch long, with .156 inch diameter shoulder 45/64 inch long, .155-40 thread, tap No. V108-----	8
7947	Nut, hexagonal, 5/64 inch thick, .183-32 thread, tap No. V110 -----	21
7948	Nut, hexagonal, 5/64 inch thick, .183-32 left thread, tap No. V111 -----	21
9253	Shoulder Screw, fillister head, 31/32 inch long, with .250 inch diameter shoulder 5/8 inch long, .214-32 thread, tap No. V113 -----	17
9263	Shoulder Screw, square head, 27/32 inch long, with .250 inch diameter shoulder 29/64 inch long, .214-32 thread, tap No. V113 -----	20
9450	Thumbscrew, knurled head, 5/8 inch long, .214-32 thread, tap No. V113 ----	19
9463	Shoulder Screw, fillister head, 1 1/16 inches long, with .250 inch diameter shoulder 49/64 inch long, .214-32 thread, tap No. V113 -----	16
9663	Shoulder Screw, fillister head, 37/64 inch long, with .220 inch diameter shoulder 9/64 inch long, .214-32 thread, tap No. V113 -----	16
9665	Shoulder Screw, fillister head, 1 1/4 inches long, has special shoulder .415 inch diameter 1/2 inch long, .214-32 thread, tap No. V113-----	12
9675	Shoulder Screw, fillister head, 1/2 inch long, with .247 inch diameter shoulder 1/4 inch long, .214-32 thread, tap No. V113 -----	16
9678	Thumbscrew, knurled head, 13/32 inch long, .146-40 thread, tap No. V107 --	20
9846	Shoulder Screw, fillister head, 63/64 inch long, with .227 inch diameter shoulder 39/64 inch long, .182-40 thread, tap No. V109 -----	17
9846 A	Shoulder Screw, fillister head, 53/64 inch long, with .228 inch diameter shoulder 39/64 inch long, .182-40 thread, tap No. V109 -----	17
9937	Nut, hexagonal, 1/8 inch thick, .182-40 thread, tap No. V109 -----	21
9950	Stop Nut, square, 3/16 inch thick, .146-40 thread, tap No. V107 -----	20
11341	Shoulder Stud, square head, 47/64 inch long, 9/32 inch of thread, .214-32 thread, tap No. V113-----	20
11540	Screw, countersunk head, 1 1/32 inches long, .219-28 thread, tap No. V116-----	13
11634 B	Shoulder Screw, fillister head, 1/2 inch long, with .247 inch diameter shoulder 17/64 inch long, .214-32 thread, tap No. V113 -----	16
11635 B	Nut, hexagonal, 13/64 inch thick, .314-24 thread, tap No. V119 -----	21
11635 E	Shoulder Screw, fillister head, 1 23/32 inches long, with 3/8 inch diameter shoulder 9/16 inch long, .368-24 thread, tap No. V119 A -----	17
11635 F	Nut, hexagonal, 7/32 inch thick, .368-24 thread, tap No. V119 A -----	21
11637 A	Screw Pin, headless, 1 1/8 inches long, with .312 inch diameter shoulder 7/16 inch long, .257-32 thread, tap No. V118 -----	9

NUMERICAL LIST OF PARTS

<u>Part No.</u>	<u>Description</u>	<u>Page No.</u>
11638 A	Screw Pin, headless, 1 inch long, with .375 inch diameter shoulder 1/2 inch long, .257-32 thread, tap No. V118 -----	9
11638 F	Shoulder Screw, fillister head, 27/32 inch long, with .375 inch diameter shoulder 3/8 inch long, with .257-32 thread, tap No. V118-----	16
11638 J	Screw, threaded end slotted, fillister head, 1 5/8 inches long, .314-24 thread, tap No. V119-----	12
11638 M	Nut, hexagonal, 1/8 inch thick, .314-24 thread, tap No. V119 -----	21
11638 N	Stud, slot in threaded end, fillister head, 2 9/16 inches long, .314-24 thread, tap No. V119-----	12
11639 A	Shoulder Screw, fillister head, 7/8 inch long, with .375 inch diameter shoulder 5/32 inch long, .257-32 thread, tap No. V118-----	16
11639 H	Screw Pin, headless, 1 7/32 inches long, with .375 inch diameter shoulder 3/4 inch long, .257-32 thread, tap No. V118 -----	9
11684 R	Nut, hexagonal, 3/8 inch thick, 5/8-11 thread, tap No. V137 -----	21
11698 L	Nut, hexagonal, 3/8 inch thick, 3/8-16 thread, tap No. V132 -----	21
11698 Q	Nut, square, 5/16 inch thick, 5/16-18 thread, tap No. V134-----	20
11947	Shoulder Screw, fillister head, 51/64 inch long, with .200 inch diameter shoulder 19/32 inch long, .182-40 thread, tap No. V109-----	17
12035	Screw Bushing, headless, 11/64 inch long, .214-32 thread, tap No. V113----	7
12062 B	Screw Pin, 1 3/8 inches long over-all, with 7/16 inch diameter flange 1/8 inch thick, .214-32 thread, tap No. V113-----	8
12538	Nut, hexagonal, 1/8 inch thick, .214-32 thread, tap No. V113-----	21
12655 A	Shoulder Screw, fillister head, 1 1/4 inches long, with .375 inch diameter shoulder 3/4 inch long, .257-32 thread, tap No. V118 -----	18
12656 E	Screw Eye, 1 3/4 inches long, with .214-32 thread at bottom of screw eye 19/32 inch long, .257-32 thread at top, tap No. V118 -----	19
12934 A	Nut, hexagonal, 3/32 inch thick, .182-40 thread, tap No. V109 -----	21
12934 B	Shoulder Screw, hexagonal head, 47/64 inch long, with .319 inch diameter shoulder 33/64 inch long, .182-40 thread, tap No. V109-----	18
12935 A	Set Screw, headless, 9/32 inch long, .146-40 thread, tap No. V107 -----	6
12981	Bolt, square head, 1 3/16 inches long, .214-32 thread, tap No. V113 -----	20
12982	Nut, hexagonal, 3/32 inch thick, .214-32 thread, tap No. V113-----	21
12982 A	Screw Bushing, hexagonal head, .214-32 internal thread, tap No. V113; .367-28 external left thread, tap No. V94 -----	7
12986 B	Screw, fillister head, 9/64 inch long, .146-40 thread, tap No. V107 -----	10
12987 A	Nut, hexagonal, 5/64 inch thick, .257-32 thread, tap No. V118-----	21
12988 A	Screw, hexagonal head, 5/16 inch long, .219-28 thread, tap No. V116-----	14
12988 B	Screw, hexagonal head, 25/64 inch long, .219-28 thread, tap No. V116-----	14
12990	Nut, hexagonal, 9/32 inch thick, .510-24 thread, tap No. V124-----	21
12993 A	Screw, hexagonal head, 1 inch long, .219-28 thread, tap No. V116-----	14
12997 A	Shoulder Screw, fillister head, 1/2 inch long, with .227 inch diameter shoulder 7/32 inch long, .182-40 thread, tap No. V109-----	16
14076	Shoulder Screw, fillister head, 27/64 inch long, with .219 inch diameter shoulder 9/64 inch long, .182-40 thread, tap No. V109-----	16
14077	Nut, hexagonal, 5/64 inch thick, .182-40 thread, tap No. V109 -----	21
14087	Thumbscrew, knurled head, 27/32 inch long, .214-32 thread, tap No. V113 -----	(-)
14791	Shoulder Screw, headless, 1 19/64 inches long, with .312 inch diameter shoulder 3/4 inch long, .257-32 thread, tap No. V118-----	9
15037 A	Nut, hexagonal, 3/32 inch thick, .214-32 thread, tap No. V113 -----	21
15037 D	Locking Screw, with handle extension, 41/64 inch long under flange, .182-40 thread, tap No. V109-----	19
15162	Shoulder Screw, fillister head, 1 inch long, with .373 inch diameter shoulder 29/64 inch long and .311 inch diameter flattened shoulder 19/64 inch long, .214-32 thread, tap No. V113 -----	18
15430 C	Nut, hexagonal, 25/64 inch thick, .368-24 left hand thread, tap No. V95-----	20
15430 D	Nut, hexagonal, 25/64 inch thick, .368-24 thread, tap No. V119 A -----	20
15433	Nut, hexagonal, 21/64 inch thick, .314-24 thread, tap No. V119 -----	20
15438 D	Shoulder Screw, fillister head, 29/64 inch long, with .187 inch diameter shoulder 1/4 inch long, .124-50 thread, tap No. V104-----	16

(-) A dash in the "Page No." column denotes the absence of an illustration.

NUMERICAL LIST OF PARTS

Part No.	Description	Page No.
15447 A	Screw Pin, flanged, 1 3/32 inches long over-all, threaded portion 7/16 inch long, .182-40 thread, tap No. V109-----	8
15453	Shoulder Screw, fillister head, 1 1/16 inches long, with .312 inch diameter shoulder 5/8 inch long, .214-32 thread, tap No. V113-----	9
15453 E	Shoulder Screw, fillister head, 1 5/16 inches long, with .312 inch diameter shoulder 5/8 inch long, .214-32 thread, tap No. V113-----	9
15455	Screw, headless, 2 5/16 inches long over-all, with pilot 1 5/8 inches long, .257-32 thread, tap No. V118-----	9
15467 A	Nut, hexagonal, slotted, 1/4 inch thick, .219-28 thread, tap No. V116-----	21
15476	Threaded Bushing, knurled head, 1 1/32 inches long, .680-24 thread, tap No. V29-----	8
15477	Nut, circular, knurled, 1/4 inch thick, .680-24 thread, tap No. V29-----	21
15481	Bolt, square head, 1 3/16 inches long, .214-32 thread, tap No. V113-----	15
15489 B	Thumbscrew, 5/16 inch long under flange, .146-40 thread, tap No. V107---	20
15498 L	Shoulder Screw, headless, 2 3/8 inches long, 5/16 inch diameter shoulder 2 inches long, .257-32 thread, tap No. V118-----	8
15773	Screw, fillister head, 1 inch long under flange, .214-32 thread, tap No. V113-----	12
15839 A	Shoulder Screw, headless, 19/32 inch long, with .265 inch diameter shoulder 5/16 inch long, .191-28 thread, tap No. V112-----	9
15852	Shoulder Stud, fillister head, 2 1/2 inches long over-all, with .310 inch diameter shoulder 1 15/16 inches long, .214-32 thread, tap No. V113-----	9
15862 H	Adaptor Screw, hexagonal head, 1 1/4 inches long, shoulder 55/64 inch long, with .182-40 internal thread 1/2 inch deep, .257-32 thread, tap No. V118-----	8
15872 D	Shoulder Screw, fillister head, 11/32 inch long, with .227 inch diameter shoulder 13/64 inch long, .182-40 thread, tap No. V109-----	16
15887	Nut, hexagonal, slotted, 1/4 inch thick, .219-28 thread, tap No. V116-----	21
16179	Nut, rectangular, 1/8 inch thick, .124-50 thread, tap No. V104-----	20
16190	Shoulder Screw, hexagonal head, 27/32 inch long, with 1/4 inch diameter shoulder 37/64 inch long, .182-40 thread, tap No. V109-----	18
16257 J	Shoulder Screw, hexagonal head, 1 5/64 inches long, with .200 inch diameter shoulder 29/32 inch long, .182-40 thread, tap No. V109-----	18
16369 D	Nut, circular, knurled, 25/64 inch thick, .257-32 thread, tap No. V118-----	21
16382	Shoulder Screw, fillister head, 7/16 inch long, with .315 inch diameter shoulder 7/32 inch long, .182-40 thread, tap No. V109-----	16
20143	Nut, hexagonal, 5/8 inch thick, 5/8-11 thread, tap No. V137-----	20
20237	Shoulder Screw, hexagonal head, 29/32 inch long, with .375 inch diameter shoulder 13/32 inch long, 1/4-20 thread, tap No. V133-----	18
20237 A	Shoulder Screw, hexagonal head, 29/32 inch long, with .375 inch diameter shoulder 13/32 inch long, 5/16-18 thread, tap No. V134-----	18
20243	Shoulder Screw, hexagonal head, 7/8 inch long, with .467 inch diameter shoulder 3/8 inch long, 7/16-14 thread, tap No. V135-----	18
20263	Shoulder Screw, hexagonal head, 1 25/32 inches long, with 1/2 inch diameter shoulder 1 1/32 inches long, 3/8-16 thread, tap No. V132-----	18
20271	Nut, hexagonal, 7/16 inch thick, 1/2-20 thread, tap No. V242-----	21
21104 H	Nut, hexagonal, 7/32 inch thick, 5/16-18 thread, tap No. V134-----	21
21185	Thumb Nut, knurled, 17/64 inch thick, .146-40 thread, tap No. V107-----	21
21185 B	Nut, rectangular, 9/32 inch thick, .146-40 thread, tap No. V107-----	20
21198 J	Nut, rectangular, 1/8 inch thick, .182-40 thread, tap No. V109-----	20
21227 J	Hand Screw, 7/8 inch long, .214-32 thread, tap No. V113-----	19
21237 W	Cap Nut, hexagonal, 1 5/32 inches long, .437-28 thread, tap No. V193----	20
21352	Screw, fillister head, 1 1/2 inches long, .404-16 thread, tap No. V122----	12
21352 A	Screw, fillister head, 2 inches long, .404-16 thread, tap No. V122-----	12
21352 B	Screw, fillister head, 1 3/4 inches long, .404-16 thread, tap No. V122----	12
21352 C	Screw, fillister head, 3 inches long, .404-16 thread, tap No. V122-----	12
21369 A	Wing Nut, 1/4-20 thread, tap No. V133-----	21
21371 CT	Cap Nut, circular, with slotted countersunk head, 7/8 inch long, 3/8-16 thread, tap No. V132-----	21
21371 LR	Cap Nut, hexagonal, 3/4 inch long, 3/8-16 thread, tap No. V132-----	20
21390 L	Nut, circular, 11/64 inch thick, .182-40 thread, tap No. V109-----	20

NUMERICAL LIST OF PARTS

Part No.	Description	Page No.
21629	Shoulder Screw, fillister head, 13/64 inch long, with .115 inch diameter shoulder 5/32 inch long, .088-64 thread, tap No. V100 -----	16
21640 AC	Shoulder Screw, fillister head, 1 9/32 inches long, with .319 inch diameter shoulder 13/16 inch long, .214-32 thread, tap No. V113 -----	17
21657 Q	Stud, headless, 1 23/64 inches long over-all, with 1/4 inch long external thread .146-40, tap No. V107; 7/16 inch deep internal thread .146-40, tap No. V107-----	9
21681	Machine Bed Screw, 5 5/8 inches long, .404-16 thread, tap No. V122 ---	19
21681 B	Machine Bed Screw, 5 3/8 inches long, .404-16 thread, tap No. V122 ---	19
HA21681	Machine Bed Screw, 6 15/32 inches long, .404-16 thread, tap No. V122 --	19
21697 M	Adjusting Screw, with screw eye, 3 15/32 inches long over-all, 3/8-16 thread, tap No. V132-----	8
21711	Nut, circular, 3/8 inch thick, .368-24 thread, tap No. V119 A -----	20
21725	Screw, headless, 19/64 inch long, with oil hole through center, .257-32 thread, tap No. V118-----	7
21745 B	Wing Nut, .183-32 thread, tap No. V110 -----	21
21745 C	Thumbscrew, 1 inch long, .183-32 thread, tap No. V110-----	20
21745 D	Thumbscrew, 11/16 inch long, .183-32 thread, tap No. V110-----	20
21754	Shoulder Screw, fillister head, 47/64 inch long, with .530 inch diameter shoulder 3/8 inch long, .314-24 thread, tap No. V119 -----	16
21756 G	Screw Pin, headless, 1/8 inch long, with .192 inch diameter shoulder, 3/8 inch long, .146-40 thread, tap No. V107 -----	9
21818 B	Nut, hexagonal, 1/2 inch thick, 1/2-13 thread, tap No. V136 -----	21
21845 D	Stud, headless, completely threaded, 1 1/2 inches long, 1/2-13 thread, tap No. V136-----	6
22503	Screw, headless, 1/2 inch long, with .110 inch diameter pilot, .182-40 thread, tap No. V109-----	7
22503 A	Screw, headless, 1/2 inch long, with .160 inch diameter pilot, .182-40 thread, tap No. V109-----	6
22503 F	Screw, headless, 13/32 inch long, .182-40 thread, tap No. V109 -----	6
22504	Shoulder Screw, fillister head, 9/16 inch long, with .160 inch diameter shoulder 15/32 inch long, .124-50 thread, tap No. V104 -----	16
22504 A	Shoulder Screw, fillister head, 15/32 inch long, with .256 inch diameter shoulder 5/32 inch long, .182-40 thread, tap No. V109 -----	16
22504 B	Shoulder Screw, fillister head, 5/32 inch long, with .216 inch diameter shoulder 1/16 inch long, with hole drilled and tapped in head; internal thread .146-40, tap No. V107; external thread .182-40, tap No. V109 -----	7
22504 C	Shoulder Screw, fillister head, 13/32 inch long, with .256 inch diameter shoulder 5/32 inch long, .182-40 thread, tap No. V109 -----	11
22504 D	Shoulder Screw, fillister head, 13/32 inch long, .319 inch diameter shoulder, .159 inch long, .182-40 thread, tap No. V109 -----	16
22507	Set Screw, square head, 3/8 inch long, 1/4-20 thread, tap No. V133 ----	15
22508	Set Screw, square head, 1/2 inch long, 1/4-20 thread, tap No. V133 ----	15
22509	Set Screw, square head, cup point, 5/8 inch long, 5/16-18 thread, tap No. V134-----	15
22509 A	Set Screw, square head, flat point, 5/8 inch long, 3/8-16 thread, tap No. V132-----	15
22510	Set Screw, square head, 5/8 inch long, 1/4-20 thread, tap No. V133 ----	15
22513	Screw, fillister head, 11/64 inch long, .146-40 thread, tap No. V107 ---	10
22513 A	Screw, fillister head, 11/64 inch long, special steel, .146-40 thread, tap No. V107-----	10
22513 B	Screw, fillister head, 7/32 inch long, .146-40 thread, tap No. V107 ----	10
22514	Screw, fillister head, 7/16 inch long, No. 14-20 thread, tap No. V130---	10
22514 A	Screw, fillister head, 3/4 inch long, No. 14-20 thread, tap No. V130 ---	10
22515	Shoulder Screw, hexagonal head, 3/8 inch long, with .186 inch diameter shoulder 1/8 inch long, .146-40 thread, tap No. V107 -----	18
22515 A	Shoulder Screw, hexagonal head, 23/32 inch long, with .225 inch diameter shoulder 13/64 inch long, .146-40 thread, tap No. V107 -----	18
22515 B	Double Shoulder Screw, hexagonal head, 21/32 inch long, with .225 inch diameter shoulder 13/64 inch long and .157 inch diameter shoulder 7/32 inch long, .146-40 thread, tap No. V107-----	18

NUMERICAL LIST OF PARTS

Part No.	Description	Page No.
22516	Screw, fillister head, 27/64 inch long, .155-40 thread, tap No. V108 -----	11
22516 A	Screw, fillister head, 1/2 inch long, .155-40 thread, tap No. V108 -----	11
22516 B	Screw, fillister head, 11/32 inch long, .155-40 thread, tap No. V108 -----	10
22517	Screw, fillister head, 7/16 inch long, .214-32 thread, tap No. V113 -----	11
22517 A	Screw, fillister head, 1 9/64 inches long, .214-32 thread, tap No. V113 ----	11
22517 B	Screw, fillister head, 3/8 inch long, .214-32 thread, tap No. V113 -----	10
22517 C	Screw, fillister head, 5/16 inch long, .214-32 external thread, tap No. V113, .124-50 internal thread, tap No. V104 -----	7
22517 D	Screw, fillister head, 1 9/64 inches long, .214-32 thread, tap No. V113 ---	12
22517 F	Screw, fillister head, 5/16 inch long, .110-50 thread, tap No. V102 for internal thread, .214-32 thread, tap No. V113 -----	7
22518	Screw, fillister head, 37/64 inch long, .191-28 thread, tap No. V112 -----	11
22519	Screw, hexagonal head, 1/4 inch long, .182-40 thread, tap No. V109 -----	14
22519 A	Screw, hexagonal head, 9/16 inch long, .155-40 thread, tap No. V108 -----	14
22519 C	Screw, hexagonal head, 15/32 inch long, .182-40 thread, tap No. V109 ----	14
22519 E	Shoulder Screw, hexagonal head, 1/2 inch long, with 1/4 inch diameter shoulder 3/32 inch long, .182-40 thread, tap No. V109-----	18
22519 F	Screw, hexagonal head, 5/8 inch long, .155-40 thread, tap No. V108 -----	14
22519 G	Screw, slotted hexagonal head, 3/16 inch long, .182-40 thread, tap No. V109 -----	14
22519 H	Screw, slotted hexagonal head, 7/16 inch long, .182-40 thread, tap No. V109 -----	14
22519 J	Screw, slotted hexagonal head, 13/16 inch long, .182-40 thread, tap No. V109 -----	14
22519 K	Screw, hexagonal head, slotted, 9/16 inch long, .182-40 thread, tap No. V109 -----	14
22520	Screw, fillister head, 3/8 inch long, .126-40 thread, tap No. V105 -----	10
22521	Screw, countersunk head, 1/2 inch long, .257-32 thread, tap No. V118 ----	13
22522	Screw, fillister head, 1 1/32 inches long, .191-28 thread, tap No. V112 ---	11
22523	Shoulder Screw, fillister head, 5/16 inch long, with .267 inch diameter shoulder 9/64 inch long, .257-32 thread, tap No. V118-----	11
22524	Screw, countersunk head, 5/16 inch long, .146-40 thread, tap No. V107 ---	13
22525	Screw, countersunk head, 5/16 inch long, .155-40 thread, tap No. V108 ---	13
22525 A	Screw, countersunk head, 5/16 inch long, .182-40 thread, tap No. V109 ---	13
22525 C	Screw, countersunk head, 25/32 inch long, .155-40 thread, tap No. V108 --	13
22526	Screw, countersunk head, 5/16 inch long, .182-40 thread, tap No. V109 ---	13
22528	Screw, fillister head, 23/64 inch long, .182-40 thread, tap No. V109 -----	10
22528 C	Screw, fillister head, 11/32 inch long, with slot in threaded end, .182-40 thread, tap No. V109 -----	11
22530	Screw, fillister head, 7/64 inch long, .214-32 thread, tap No. V113 -----	10
22532	Screw, fillister head, 3/8 inch long under flange, .146-40 thread, tap No. V107 -----	12
22533	Screw, headless, 55/64 inch long, .257-32 thread, tap No. V118 -----	9
22533 A	Screw, headless, 7/8 inch long, .257-32 thread, tap No. V118 -----	6
22535	Screw, countersunk head, 1 3/64 inches long, .214-32 thread, tap No. V113 -----	13
22536	Set Screw, headless, 5/16 inch long, 3/8-16 thread, tap No. V132-----	6
22537	Screw, headless, 35/64 inch long, .257-32 thread, tap No. V118 -----	6
22537 A	Set Screw, headless, 3/4 inch long, .368-24 thread, tap No. V119 A-----	6
22538	Cap Screw, fillister head, 1 1/2 inches long, 5/16-24 thread, tap No. V185 -----	11
22539	Screw, headless, 5/32 inch long, .671-36 thread, tap No. V126 -----	6
22539 A	Screw, headless, 5/32 inch long, .510-24 thread, tap No. V124 -----	6
22539 C	Screw, headless, 5/32 inch long, .671-36 thread, tap No. V126 -----	6
22539 D	Screw, headless, 27/64 inch long, .869-20 thread, tap No. V97 -----	6
22539 E	Screw, headless, 5/32 inch long, .548-18 thread, tap No. V125 -----	6
22539 F	Screw, headless, 5/32 inch long, .671-36 thread, tap No. V126 -----	6
22539 G	Screw, headless, 5/32 inch long, .597-32 thread, tap No. V96 -----	6
22539 H	Screw, headless, 5/32 inch long, .510-24 thread, tap No. V124 -----	6
22539 K	Screw, headless, 5/32 inch long, .437-28 thread, tap No. V193 -----	6
22539 L	Plug Screw, headless, 1/4 inch long, 1/4-20 thread, tap No. V133 -----	6
22539 M	Plug Screw, headless, 3/8 inch long, 7/16-27 thread, tap No. V160 -----	6

NUMERICAL LIST OF PARTS

Part No.	Description	Page No.
22539 N	Plug Screw, headless, 11/32 inch long, .869-20 thread, tap No. V97 -----	6
22539 P	Plug Screw, headless, 27/64 inch long, .804-24 thread, tap No. V264 -----	6
22539 R	Plug Screw, tapered, 17/32 inch long, 1/2-14 pipe thread, tap No. V211 ---	6
22540	Screw, headless, 9/64 inch long, with .375 inch diameter hole through center, .671-36 thread, tap No. V126-----	7
22541	Screw, fillister head, 21/32 inch long, .183-32 thread, tap No. V110 -----	11
22541 B	Screw, fillister head, 15/32 inch long, .183-32 thread, tap No. V110 -----	10
22542	Screw, fillister head, 7/32 inch long, .146-40 thread, tap No. V107 -----	10
22543	Screw, fillister head, 9/16 inch long under flange, .146-40 thread, tap No. V107 -----	12
22547	Screw, round head, 5/8 inch long, No. 14-20 thread, tap No. V130 -----	13
22547 A	Screw, round head, 1/8 inch long, .110-50 thread, tap No. V102 -----	13
22547 B	Screw, round head, 9/32 inch long, .124-50 thread, tap No. V104 -----	13
22547 C	Screw, round head, 5/32 inch long, .110-50 thread, tap No. V102 -----	13
22548	Screw, fillister head, 7/16 inch long, .214-32 thread, tap No. V113 -----	10
22548 A	Screw, fillister head, 5/16 inch long, No. 8-32 thread, tap No. V129 -----	10
22549	Screw Pin, length over-all 9/16 inch, .214-32 thread, tap No. V113 -----	9
22550	Screw, fillister head, 7/64 inch long, .146-40 thread, tap No. V107 -----	10
22551	Thumbscrew, knurled head, 15/64 inch long, .146-40 thread, tap No. V107 -----	20
22551 A	Thumbscrew, knurled head, 5/8 inch long, No. 14-20 thread, tap No. V130 -----	20
22551 B	Thumbscrew, knurled head, 11/64 inch long, .146-40 thread, tap No. V107 -----	20
22557	Shoulder Screw, fillister head, 1/2 inch long, with .319 inch diameter shoulder 9/64 inch long, .214-32 thread, tap No. V113-----	16
22557 A	Shoulder Screw, fillister head, 1/2 inch long, with .257 inch diameter shoulder 1/4 inch long, .214-32 thread, tap No. V113-----	16
22557 B	Shoulder Screw, fillister head, 53/64 inch long, with double shoulder 1/2 and 3/8 inch diameters, 13/64 and 3/16 inch long respectively, .214-32 thread, tap No. V113 -----	18
22557 D	Shoulder Screw, fillister head, 35/64 inch long, .319 inch diameter shoulder .360 inch long, .214-32 thread, tap No. V113-----	16
22557 E	Shoulder Screw, fillister head, 13/16 inch long, .375 inch diameter shoulder .442 inch long, .214-32 thread, tap No. V113-----	16
22559	Shoulder Screw, fillister head, 19/32 inch long, with .156 inch diameter shoulder 11/32 inch long, .146-40 thread, tap No. V107-----	16
22559 A	Shoulder Screw, fillister head, 35/64 inch long, with .155 inch diameter shoulder 19/64 inch long, .146-40 thread, tap No. V107-----	16
22559 B	Shoulder Screw, fillister head, 53/64 inch long, with .158 inch diameter shoulder 29/64 inch long, .155-40 thread, tap No. V108-----	17
22559 C	Shoulder Screw, fillister head, 23/32 inch long, with .162 inch diameter shoulder 3/8 inch long, .155-40 thread, tap No. V108-----	16
22559 D	Shoulder Screw, fillister head, 31/64 inch long, with .155 inch diameter shoulder 19/64 inch long, .146-40 thread, tap No. V107-----	16
22559 E	Shoulder Screw, fillister head, 57/64 inch long, with .162 inch diameter shoulder 33/64 inch long, .155-40 thread, tap No. V108-----	17
22559 F	Shoulder Screw, fillister head, 21/32 inch long, with .163 inch diameter shoulder .437 inch long, .146-40 thread, tap No. V107-----	16
22559 G	Shoulder Screw, fillister head, 25/32 inch long, with .163 inch diameter shoulder 5/16 inch long, .155-40 thread, tap No. V108-----	17
22559 H	Shoulder Screw, fillister head, 1 5/16 inch long, .250 inch diameter shoulder 1/2 inch long, .146-40 thread, tap No. V107-----	17
22559 J	Shoulder Screw, fillister head, 49/64 inch long, .217 inch diameter shoulder .485 inch long, .155-40 thread, tap No. V108-----	16
22560	Screw, headless, 3/32 inch long, .182-40 thread, tap No. V109 -----	6
22560 A	Set Screw, headless, 11/32 inch long, .182-40 thread, tap No. V109-----	6
22560 B	Screw, headless, 15/64 inch long, .182-40 thread, tap No. V109 -----	6
22560 G	Spot Screw, headless, 3/16 inch long, .214-32 thread, tap No. V113-----	7
22561	Screw, fillister head, 9/64 inch long, .124-50 thread, tap No. V104 -----	10
22561 A	Screw, fillister head, 5/64 inch long, .124-50 thread, tap No. V104 -----	10
22562	Screw, fillister head, 7/32 inch long, .146-40 thread, tap No. V107 -----	11

NUMERICAL LIST OF PARTS

Part No.	Description	Page No.
22562 A	Screw, fillister head, 9/32 inch long, .146-40 thread, tap No. V107 -----	10
22562 B	Screw, fillister head, 9/32 inch long, .146-40 thread, tap No. V107 -----	10
22563	Screw, fillister head, 5/32 inch long, .124-50 thread, tap No. V104 -----	11
22564	Screw, fillister head, 5/32 inch long, .146-40 thread, tap No. V107 -----	10
22564 B	Screw, fillister head, 5/32 inch long, .146-40 thread, tap No. V107 -----	10
22564 D	Screw, fillister head, 3/16 inch long, .146-40 thread, tap No. V107 -----	10
22564 E	Screw, fillister head, 3/64 inch long, .073-72 thread, tap No. V151 -----	10
22564 F	Screw, fillister head, 5/64 inch long, .073-72 thread, tap No. V151 -----	10
22564 G	Screw, fillister head, .109 inch long, .146-40 thread, tap No. V107 -----	10
22564 H	Screw, fillister head, 5/32 inch long, .146-40 thread, tap No. V107 -----	10
22565	Set Screw, headless, 11/64 inch long, .183-32 thread, tap No. V110-----	6
22565 A	Set Screw, headless, 19/64 inch long, .124-50 thread, tap No. V104-----	9
22565 B	Set Screw, headless, cup point, 3/8 inch long, .183-32 thread, tap No. V110 -----	6
22565 C	Set Screw, headless, 3/16 inch long, .146-40 thread, tap No. V107-----	6
22565 D	Screw, headless, 3/8 inch long, .146-40 thread, tap No. V107 -----	6
22565 E	Screw, headless, 9/16 inch long, round point, .146-40 thread, tap No. V107 -----	6
22565 F	Spot Screw, headless, 1/2 inch long, .183-32 thread, tap No. V110-----	6
22565 H	Spot Screw, headless, 1/2 inch long, .183-32 thread, tap No. V110-----	6
22565 J	Screw, headless, 3/32 inch long, .073-72 thread, tap No. V151-----	6
22566	Shoulder Screw, fillister head, 1 9/16 inches long, with .437 inch diameter shoulder 1 1/16 inches long, .368-24 thread, tap No. V119 A ---	17
22566 A	Shoulder Screw, fillister head, 1 5/32 inches long, with .499 inch diameter shoulder 9/16 inch long, .368-24 thread, tap No. V119 A -----	17
22566 B	Shoulder Screw, fillister head, 1 1/16 inches long, with .437 inch diameter shoulder 5/8 inch long, .368-24 thread, tap No. V119 A -----	17
22566 C	Shoulder Screw, fillister head, 1 3/8 inches long, with .499 inch diameter shoulder 9/16 inch long, .368-24 thread, tap No. V119 A -----	17
22567	Screw, hexagonal head, 3/8 inch long, .182-40 thread, tap No. V109 -----	14
22567 A	Screw, hexagonal head, 13/32 inch long, .182-40 thread, tap No. V109 -----	14
22568	Screw, fillister head, 7/16 inch long under flange, .155-40 thread, tap No. V108 -----	12
22569	Screw, fillister head, 33/64 inch long, .183-32 thread, tap No. V110 -----	11
22569 A	Screw, fillister head, cup point, 3/16 inch long, .183-32 thread, tap No. V110 -----	11
22569 B	Screw, fillister head, 7/16 inch long, .183-32 thread, tap No. V110 -----	10
22569 C	Screw, fillister head, 11/32 inch long, .183-32 thread, tap No. V110 -----	10
22569 D	Screw, fillister head, 1/4 inch long, .183-32 thread, tap No. V110 -----	10
22569 F	Screw, fillister head, 9/32 inch long, .183-32 thread, tap No. V110 -----	10
22569 G	Screw, fillister head, 11/32 inch long, .183-32 thread, tap No. V110 -----	10
22569 H	Screw, fillister head, cup point, 15/64 inch long, with "Nylok" insert, .183-32 thread, tap No. V110 -----	10
22570	Screw, fillister head, 3/16 inch long, .182-40 thread, tap No. V109 -----	10
22570 A	Screw, fillister head, 19/64 inch long, .182-40 thread, tap No. V109 -----	10
22570 B	Screw, fillister head, 3/16 inch long, .182-40 thread, tap No. V109 -----	10
22570 C	Screw, fillister head, 19/32 inch long, .257-32 thread, tap No. V118 -----	10
22571	Screw, headless, 3/8 inch long, .404-16 thread, tap No. V122 -----	6
22571 A	Screw, headless, 9/32 inch long, .368-24 thread, tap No. V119 A -----	6
22571 B	Pipe Plug, headless, 3/8 inch long, 1/8-27 pipe thread, tap No. V158-----	7
22571 D	Screw, headless, 1/8 inch long, .368-24 thread, tap No. V119 A -----	6
22571 E	Magnetic Plug Screw, 11/16 inch long, thread part 3/8 inch long, 1/8-27 pipe thread, tap No. V158 -----	7
22572	Screw, fillister head, 7/16 inch long, .183-32 thread, tap No. V110 -----	11
22572 A	Screw, fillister head, 35/64 inch long, .183-32 thread, tap No. V110 -----	11
22572 B	Screw, fillister head, socket type, 7/16 inch long, .183-32 thread, tap No. V110 -----	12
22573	Screw, fillister head, 1/4 inch long, .126-40 thread, tap No. V105 -----	11
22574	Screw, countersunk head, 21/32 inch long, .214-32 thread, tap No. V113---	13
22574 A	Screw, countersunk head, 1 1/32 inches long, .214-32 thread, tap No. V113 -----	13
22574 C	Screw, countersunk head, 3/4 inch long, 214-32 thread, tap No. V113-----	13

NUMERICAL LIST OF PARTS

<u>Part No.</u>	<u>Description</u>	<u>Page No.</u>
22575	Screw, headless, 27/64 inch long, .146-40 thread, tap No. V107 -----	7
22576	Screw, fillister head, 9/32 inch long, .182-40 thread, tap No. V109 -----	10
22577	Screw Pin, 1 inch long, .191-28 thread, tap No. V112-----	9
22577 A	Adjusting Screw, headless, 7/8 inch long, .110-50 internal thread, tap No. V102, .257-32 external thread, tap No. V118-----	7
22577 B	Hinge Screw, 1 7/32 inches long, .140 inch diameter pilot 1 7/64 inches long, .214-32 thread, tap No. V113 -----	9
22578	Screw, fillister head, 11/32 inch long, .214-32 thread, tap No. V113 -----	16
22579	Screw Eye, 1 1/4 inches long, .257-32 thread, tap No. V118-----	19
22580	Set Screw, headless, 9/64 inch long, .214-32 thread, tap No. V113-----	6
22580 A	Set Screw, headless, 9/32 inch long, .214-32 thread, tap No. V113-----	6
22580 D	Set Screw, headless, 1/8 inch long, .214-32 thread, tap No. V113-----	6
22581	Screw, fillister head, 27/64 inch long, .182-40 thread, tap No. V109 -----	10
22582	Shoulder Screw, fillister head, 7/8 inch long, with .162 inch diameter shoulder 19/32 inch long, .155-40 thread, tap No. V108-----	17
22584	Screw, fillister head, 3/16 inch long, .182-40 thread, tap No. V109 -----	10
22585	Screw, fillister head, 11/32 inch long, .146-40 thread, tap No. V107 -----	10
22585 A	Screw, fillister head, 5/16 inch long, .146-40 thread, tap No. V107 -----	10
22585 B	Screw, fillister head, 3/8 inch long, .146-40 thread, tap No. V107 -----	10
22585 C	Screw, fillister head, 13/64 inch long, .146-40 thread, tap No. V107 -----	10
22585 G	Screw, fillister head, 11/32 inch long, .146-40 thread, tap No. V107 -----	9
22585 H	Screw, fillister head, 5/8 inch long, .182-40 thread, tap No. V109 -----	9
22585 R	Screw, fillister head, 15/32 inch long, .146-40 thread, tap No. V107 -----	10
22585 S	Shoulder Screw, fillister head, 5/8 inch long, .153 inch diameter shoulder 7/64 inch long, .146-40 thread, tap No. V107-----	10
22586	Screw, headless, 1/8 inch long, .257-32 thread, tap No. V118 -----	6
22586 A	Screw, headless, 5/32 inch long, with oil hole through center, .257-32 thread, tap No. V118 -----	7
22586 B	Screw, headless, 1/8 inch long, 1/4-32 thread, tap No. V140 -----	6
22586 C	Screw, fillister head, 35/64 inch long, .155-40 thread, tap No. V108 -----	10
22586 D	Set Screw, headless, 3/8 inch long, 1/4-24 thread, tap No. V288-----	6
22586 R	Screw, fillister head, 7/16 inch long, 1/4-32 thread, tap No. V140 -----	10
22587	Shoulder Screw, fillister head, 25/32 inch long, with .221 inch diameter shoulder 7/16 inch long, .219-28 thread, tap No. V116-----	17
22587 B	Shoulder Screw, fillister head, 31/64 inch long, with .187 inch diameter shoulder 15/64 inch long, .183-32 thread, tap No. V110-----	17
22587 C	Screw, fillister head, 1 1/16 inches long, .219-28 thread, tap No. V116----	11
22587 D	Shoulder Screw, fillister head, 13/32 inch long, with .186 inch diameter shoulder 13/64 inch long, .183-32 thread, tap No. V110-----	17
22587 E	Shoulder Screw, fillister head, 19/32 inch long, with .186 inch diameter shoulder 11/32 inch long, .183-32 thread, tap No. V110-----	17
22587 F	Screw, fillister head, 25/32 inch long, special steel, .219-28 thread, tap No. V116 -----	11
22587 H	Shoulder Screw, fillister head, 23/32 inch long, with .188 inch diameter shoulder 3/8 inch long, .182-40 thread, tap No. V109 -----	16
22587 J	Screw, fillister head, 37/64 inch long, with .187 inch diameter shoulder 15/64 inch long, .183-32 thread, tap No. V110-----	17
22588	Screw, hexagonal head, 3/16 inch long, .155-40 thread, tap No. V108 -----	14
22588 A	Screw, hexagonal head, 11/32 inch long, .155-40 thread, tap No. V108 ----	14
22588 B	Screw, hexagonal head, 17/64 inch long, .155-40 thread, tap No. V108 ----	14
22588 E	Screw, hexagonal head, 31/64 inch long, with .024 inch slot 7/32 inch long in threaded portion, .124-50 thread, tap No. V104 -----	14
22589	Screw, countersunk head, 1/4 inch long, .146-40 thread, tap No. V107 ----	13
22590	Spot Screw, headless, 17/32 inch long, .257-32 thread, tap No. V118-----	6
22590 A	Spot Screw, headless, 9/16 inch long, made of special steel, cone point, .257-32 thread, tap No. V118 -----	6
22591	Screw, headless, 5/16 inch long, .257-32 thread, tap No. V118 -----	6
22591 A	Set Screw, headless, cup point, 5/16 inch long, .257-32 thread, tap No. V118 -----	6
22591 G	Screw, square head, cup point, 5/8 inch long, .257-32 thread, tap No. V118 -----	15
22592	Screw, fillister head, 1 11/64 inches long, .183-32 thread, tap No. V110 ---	11

NUMERICAL LIST OF PARTS

Part No.	Description	Page No.
22593	Screw, fillister head, 9/32 inch long, .124-50 thread, tap No. V104 ----	11
22594	Shoulder Screw, fillister head, 27/64 inch long, with .157 inch diameter shoulder 1/4 inch long, .146-40 thread, tap No. V107 -----	16
22595	Shoulder Screw, fillister head, 31/64 inch long, with .156 inch diameter shoulder 15/64 inch long, .146-40 thread, tap No. V107 -----	16
22596	Screw, fillister head, 35/64 inch long, .182-40 thread, tap No. V109 ---	11
22596 B	Screw, fillister head, 15/64 inch long, .182-40 thread, tap No. V109 ---	10
22596 C	Spot Screw, fillister head, 5/16 inch long, .182-40 thread, tap No. V109-----	11
22596 D	Screw, fillister head, 3/8 inch long, .182-40 thread, tap No. V109 -----	10
22596 E	Screw, fillister head, socket type, 3/8 inch long, .182-40 thread, tap No. V109-----	12
22597	Spot Screw, headless, 1/2 inch long, .214-32 thread, tap No. V113 -----	6
22597 A	Set Screw, headless, 13/32 inch long, .214-32 thread, tap No. V113 -----	6
22597 B	Spot Screw, headless, 1/2 inch long, .214-32 thread, tap No. V113 -----	6
22597 E	Set Screw, headless, 5/8 inch long, .214-32 thread, tap No. V113 -----	6
22598	Shoulder Screw, fillister head, 23/32 inch long, with .249 inch diameter shoulder 27/64 inch long, .182-40 thread, tap No. V109 -----	16
22598 A	Shoulder Screw, fillister head, 3/4 inch long, with 1/4 inch diameter shoulder 1/2 inch long, .182-40 thread, tap No. V109 -----	17
22598 C	Shoulder Screw, fillister head, 31/64 inch long, with 9/32 inch diameter shoulder, 7/64 inch long, .216-22 thread, tap No. V115 -----	16
22598 D	Shoulder Screw, fillister head, 13/16 inch long, with 1/4 inch diameter shoulder 1/2 inch long, .182-40 thread, tap No. V109 -----	17
22598 E	Shoulder Screw, fillister head, 11/16 inch long, with .250 inch diameter shoulder 7/16 inch long, .182-40 thread, tap No. V109 -----	17
22599	Shoulder Screw, fillister head, 5/32 inch long, with .138 inch diameter shoulder 1/32 inch long, .110-50 thread, tap No. V102 -----	16
22599 C	Screw, fillister head, 27/32 inch long, with .110 inch diameter shoulder 5/8 inch long, .110-50 thread, tap No. V102-----	11
22603	Cap Screw, hexagonal head, 3/4 inch long, 3/8-16 thread, tap No. V132-----	15
22604	Cap Screw, hexagonal head, 1 inch long, 3/8-16 thread, tap No. V132 ---	15
22605	Cap Screw, hexagonal head, 1 1/4 inches long, 3/8-16 thread, tap No. V132-----	15
22607 A	Cap Screw, hexagonal head, 1 inch long, 1/2-13 thread, tap No. V136 ---	15
22608 A	Cap Screw, hexagonal head, 1 1/4 inches long, 1/2-13 thread, tap No. V136-----	15
22609 A	Cap Screw, hexagonal head, 1 1/2 inches long, 1/2-13 thread, tap No. V136-----	15
22609 C	Cap Screw, hexagonal head, 1 1/2 inches long, with slot in threaded portion, 1/2-13 thread, tap No. V136-----	14
22610	Cap Screw, hexagonal head, 1 3/4 inches long, 1/2-12 thread -----	14
22610 A	Cap Screw, hexagonal head, 1 3/4 inches long, 1/2-13 thread, tap No. V136-----	15
22611 A	Cap Screw, hexagonal head, 2 1/2 inches long, 1/2-13 thread, tap No. V136-----	15
22612	Cap Screw, hexagonal head, 3 inches long, 1/2-12 thread -----	(-)
22612 A	Cap Screw, hexagonal head, 3 inches long, 1/2-13 thread, tap No. V136-----	15
22613	Cap Screw, hexagonal head, 1 1/2 inches long, 5/8-11 thread, tap No. V137-----	14
22613 V-64	Cap Screw, hexagonal head, 1 inch long, 5/8-11 thread, tap No. V137---	15
22613 V-256	Cap Screw, hexagonal head, 4 inches long, 5/8-11 thread, tap No. V137 -	15
22614	Cap Screw, hexagonal head, 3 1/4 inches long, 5/8-11 thread, tap No. V137-----	14
22615	Cap Screw, fillister head, 1/2 inch long, 1/4-20 thread, tap No. V133 --	11
22616	Cap Screw, fillister head, 3/4 inch long, 1/4-20 thread, tap No. V133 --	11
22617	Cap Screw, fillister head, 1 inch long, 1/4-20 thread, tap No. V133 ----	11

(-) A dash in the "Page No." column denotes the absence of an illustration.

NUMERICAL LIST OF PARTS

<u>Part No.</u>	<u>Description</u>	<u>Page No.</u>
22617 A	Cap Screw, fillister head, 1 1/4 inches long, 3/8-16 thread, tap No. V132-----	12
22617 M-48	Cap Screw, fillister head, 3/4 inch long, 3/8-16 thread, tap No. V132---	12
22617 M-64	Cap Screw, fillister head, 1 inch long, 3/8-16 thread, tap No. V132 ----	12
22617 M-112	Cap Screw, fillister head, 1 3/4 inches long, 3/8-16 thread, tap No. V132-----	12
22617 P-48	Cap Screw, fillister head, 3/4 inch long, 7/16-14 thread, tap No. V135--	12
22618	Cap Screw, fillister head, 2 1/4 inches long, 3/8-16 thread, tap No. V132-----	12
22619 R-32	Cap Screw, fillister head, 2 1/4 inches long, 1/2-13 thread, tap No. V136-----	12
22620	Set Screw, headless, 1/2 inch long, 3/8-16 thread, tap No. V132 -----	6
22620 H-16	Set Screw, headless, 1/4 inch long, 1/4-20 thread, tap No. V133 -----	6
22620 H-20	Set Screw, headless, 5/16 inch long, 1/4-20 thread, tap No. V133 -----	6
22620 K-64	Set Screw, headless, cup point, 1 inch long, 5/16-18 thread, tap No. V134-----	6
22620 M-24	Set Screw, headless, cup point, 3/8 inch long, 3/8-16 thread, tap No. V132-----	6
22620 R-56	Set Screw, headless, cup point, 7/8 inch long, 1/2-13 thread, tap No. V136-----	6
22620 R-80	Set Screw, headless, cup point, 1 1/4 inches long, 1/2-13 thread, tap No. V136-----	6
22621	Set Screw, headless, 3/4 inch long, 3/8-16 thread, tap No. V132 -----	6
22621 K-48	Spot Screw, headless, cone point, 3/4 inch long, 5/16-18 thread, tap No. V134-----	6
22621 M-48	Spot Screw, headless, cone point, 3/4 inch long, 3/8-16 thread, tap No. V132-----	6
22621 M-96	Spot Screw, headless, cone point, 1 1/2 inches long, 3/8-16 thread, tap No. V132-----	6
22622	Set Screw, headless, cup point, 1/2 inch long, 5/16-18 thread, tap No. V134-----	6
22624 K-40	Set Screw, square head, 5/8 inch long, 5/16-18 thread, tap No. V134 ---	15
22626	Set Screw, square head, cup point, 5/8 inch long, 1/4-20 thread, tap No. V133-----	15
22627	Set Screw, square head, cup point, 3/4 inch long, 5/16-18 thread, tap No. V134-----	15
22627 A	Set Screw, headless, 5/8 inch long, 5/16-18 thread, tap No. V134 -----	6
22628	Set Screw, square head, 3/4 inch long, 3/8-16 thread, tap No. V132 ----	15
22628 A	Set Screw, square head, 1 inch long, 3/8-16 thread, tap No. V132 -----	15
22628 M-40	Set Screw, square head, 5/8 inch long, 3/8-16 thread, tap No. V132 ----	15
22629	Set Screw, square head, 1 1/4 inches long, 3/8-16 thread, tap No. V132-----	15
22630	Set Screw, square head, 1 1/2 inches long, 3/8-16 thread, tap No. V132-----	15
22631	Set Screw, square head, 7/8 inch long, 7/16-14 thread, tap No. V135 ---	15
22632	Set Screw, square head, 1 inch long, 1/2-12 thread -----	15
22632 A	Set Screw, square head, cup point, 1 inch long, 1/2-13 thread, tap No. V136-----	15
22632 F-24	Set Screw, square head, cup point, 3/8 inch long, No. 10-24 thread, tap No. V208-----	15
22632 R-48	Set Screw, square head, cup point, 3/4 inch long, 1/2-13 thread, tap No. V136-----	15
22632 R-224	Set Screw, square head, cup point, 3 1/2 inches long, 1/2-13 thread, tap No. V136-----	15
22633	Set Screw, square head, 1 1/2 inches long, 1/2-12 thread -----	15
22633 A	Set Screw, square head, 2 1/2 inches long, 1/2-12 thread-----	15
22633 B	Set Screw, square head, cup point, 2 1/2 inches long, 1/2-13 thread, tap No. V136-----	15
22633 C	Set Screw, square head, 1 1/2 inches long, 1/2-13 thread, tap No. V136-----	15
22634	Set Screw, square head, 4 inches long, 5/8-11 thread, tap No. V137 ----	15

NUMERICAL LIST OF PARTS

<u>Part No.</u>	<u>Description</u>	<u>Page No.</u>
22635	Machine Screw, round head, 1/2 inch long, 1/4-20 thread, tap No. V133-----	13
22635 B-20	Machine Screw, round head, 5/16 inch long, No. 8-32 thread, tap No. V129-----	13
22635 C-12	Machine Screw, round head, 3/16 inch long, No. 6-32 thread, tap No. V128-----	13
22635 F-32	Machine Screw, round head, 1/2 inch long, No. 10-24 thread, tap No. V208-----	13
22637	Machine Screw, countersunk head, 1 inch long, 5/16-18 thread, tap No. V134-----	13
22637 A	Machine Screw, countersunk head, 1 1/2 inches long, 5/16-18 thread, tap No. V134-----	13
22637 B	Machine Screw, countersunk head, 2 1/2 inches long, 5/16-18 thread, tap No. V134-----	13
22637 D	Machine Screw, countersunk head, 1 3/4 inches long, 5/16-18 thread, tap No. V134-----	13
22637 F	Machine Screw, countersunk head, 1 1/4 inches long, 5/16-18 thread, tap No. V134-----	13
22637 H-48	Machine Screw, countersunk head, 3/4 inch long, 1/4-20 thread, tap No. V133-----	13
22637 K-24	Machine Screw, countersunk head, 3/8 inch long, 5/16-18 thread, tap No. V134-----	13
22637 M-96	Machine Screw, countersunk head, 1 1/2 inches long, 3/8-16 thread, tap No. V132-----	13
22637 M-144	Machine Screw, countersunk head, 2 1/4 inches long, 3/8-16 thread, tap No. V132-----	13
22637 N-32	Machine Screw, countersunk head, 1/2 inch long, No. 8-32 thread, tap No. V129-----	13
22638	Machine Screw, countersunk head, 1 1/4 inches long, 3/8-16 thread, tap No. V132-----	13
22638 B	Machine Screw, countersunk head, 3/4 inch long, 3/8-16 thread, tap No. V132-----	13
22639	Cap Screw, hexagonal head, 2 inches long, .404-16 thread, tap No. V122-----	14
22639 A	Cap Screw, hexagonal head, 5 inches long, .404-16 thread, tap No. V122-----	(-)
22639 B	Cap Screw, hexagonal head, 1 1/2 inches long, .404-16 thread, tap No. V122-----	14
22639 C	Cap Screw, hexagonal head, 1 1/4 inches long, .404-16 thread, tap No. V122-----	14
22640	Cap Screw, hexagonal head, 1 3/4 inches long, 3/8-16 thread, tap No. V132-----	14
22640 H-32	Cap Screw, hexagonal head, 1/2 inch long, 1/4-20 thread, tap No. V133-----	14
22640 H-128	Cap Screw, hexagonal head, 2 inches long, 1/4-20 thread, tap No. V133-----	14
22640 M-32	Cap Screw, hexagonal head, 1/2 inch long, 3/8-16 thread, tap No. V132-----	14
22640 M-96	Cap Screw, hexagonal head, 1 1/2 inches long, 3/8-16 thread, tap No. V132-----	14
22640 M-144	Cap Screw, hexagonal head, 2 1/4 inches long, 3/8-16 thread, tap No. V132-----	14
22640 P-80	Cap Screw, hexagonal head, 1 1/4 inches long, 7/16-14 thread, tap No. V135-----	(-)
22640 P-96	Cap Screw, hexagonal head, 1 1/2 inches long, 7/16-14 thread, tap No. V135-----	(-)
22640 R-112	Cap Screw, hexagonal head, 1 3/4 inches long, 1/2-20 thread, tap No. V242-----	14
22640 R-224	Cap Screw, hexagonal head, 3 1/2 inches long, 1/2-13 thread, tap No. V136-----	14

(-) A dash in the 'Page No.' column denotes the absence of an illustration.

NUMERICAL LIST OF PARTS

<u>Part No.</u>	<u>Description</u>	<u>Page No.</u>
22641	Cap Screw, hexagonal head, 2 inches long, 3/8-16 thread, tap No. V132-----	14
22642	Cap Screw, hexagonal head, 1 inch long, 5/16-18 thread, tap No. V134--	14
22642 K-32	Cap Screw, hexagonal head, 1/2 inch long, 5/16-18 thread, tap No. V134-----	14
22642 K-48	Cap Screw, hexagonal head, 3/4 inch long, 5/16-18 thread, tap No. V134-----	14
22642 K-80	Cap Screw, hexagonal head, 1 1/4 inches long, 7/8 inch of thread, 5/16-18 thread, tap No. V134-----	14
22642 K-104	Cap Screw, hexagonal head, 1 5/8 inches long, 5/16-18 thread, tap No. V134-----	14
22642 K-112	Cap Screw, hexagonal head, 1 3/4 inches long, 5/16-18 thread, tap No. V134-----	14
22643 K-64	Set Screw, square head, cup point, 1 inch long, 5/16-18 thread, tap No. V134-----	15
22644 K-64	Cap Screw, hexagonal head, 1 inch long, 5/16-24 thread, tap No. V185--	14
22644 K-80	Cap Screw, hexagonal head, 1 1/4 inches long, 5/16-24 thread, tap No. V185-----	14
22645 H-48	Cap Screw, hexagonal head, 3/4 inch long, 1/4-28 thread, tap No. V146-----	14
22645 H-64	Cap Screw, hexagonal head, 1 inch long, 1/4-28 thread, tap No. V146---	14
22647 K-24	Thumbscrew, 3/8 inch long, No. 8-32 thread, tap No. V129-----	20
22647 K-48	Thumbscrew, 3/4 inch long, 5/16-18 thread, tap No. V134-----	20
22648 Z-160	Cap Screw, hexagonal head, 2 1/2 inches long, 3/4-10 thread-----	15
22649 F-16	Machine Screw, round head, 1/4 inch long, No. 10-32 thread, tap No. V209-----	13
22649 K-96	Set Screw, square head, round point, 1 1/2 inches long, 5/16-18 thread, tap No. V134-----	15
22650 AD-4	Set Screw, headless, socket type, flat point, 1/4 inch long, 1/4-20 thread, tap No. V133-----	7
22650 AE-4	Set Screw, headless, socket type, flat point, 1/4 inch long, 5/16-18 thread, tap No. V134-----	7
22650 AE-6	Set Screw, headless, socket type, flat point, 3/8 inch long, 5/16-18 thread, tap No. V134-----	7
22650 AF-8	Screw, headless, socket type, flat point, 1/2 inch long, 3/8-16 thread, tap No. V132-----	7
22650 CB-3	Set Screw, headless, socket type, cup point, 3/16 inch long, No. 10-24 thread, tap No. V208-----	7
22650 CB-4	Set Screw, headless, socket type, cup point, 1/4 inch long, No. 10-24 thread, tap No. V208-----	7
22650 CD-4	Set Screw, headless, socket type, cup point, 1/4 inch long, 1/4-20 thread, tap No. V133-----	7
22650 CD-6	Set Screw, headless, socket type, cup point, 3/8 inch long, 1/4-20 thread, tap No. V133-----	7
22650 CE-6	Set Screw, headless, socket type, cup point, 3/8 inch long, 5/16-18 thread, tap No. V134-----	7
22650 CF-10	Set Screw, headless, socket type, cup point, 5/8 inch long, 3/8-16 thread, tap No. V132-----	7
22650 CH-10	Set Screw, headless, socket type, cup point, 5/8 inch long, 1/2-13 thread, tap No. V136-----	7
22651 CB-4	Set Screw, headless, socket type, cup point, 1/4 inch long, No. 10-32 thread, tap No. V209-----	7
22651 CD-3	Set Screw, headless, socket type, cup point, 3/16 inch long, 1/4-28 thread, tap No. V146-----	7
22651 CD-4	Set Screw, headless, socket type, cup point, 1/4 inch long, 1/4-28 thread, tap No. V146-----	7
22651 CD-5	Set Screw, headless, socket type, cup point, 5/16 inch long, 1/4-28 thread, tap No. V146-----	7
22652 A-6	Cap Screw, socket type, 3/8 inch long, No. 8-32 thread, tap No. V129---	12
22652 B-8	Cap Screw, fillister head, socket type, 1/2 inch long, No. 10-24 thread, tap No. V208-----	12

NUMERICAL LIST OF PARTS

<u>Part No.</u>	<u>Description</u>	<u>Page No.</u>
22652 B-10	Cap Screw, fillister head, socket type, 5/8 inch long, No. 10-24 thread, tap No. V208-----	12
22652 D-6	Cap Screw, fillister head, socket type, 3/8 inch long, 1/4-20 thread, tap No. V133-----	12
22652 D-12	Cap Screw, fillister head, socket type, 3/4 inch long, 1/4-20 thread, tap No. V133-----	12
22652 D-20	Cap Screw, fillister head, socket type, 1 1/4 inches long, 1/4-20 thread, tap No. V133-----	12
22652 E-14	Cap Screw, fillister head, socket type, 7/8 inch long, 5/16-18 thread, tap No. V134-----	12
22652 E-20	Cap Screw, fillister head, socket type, 1 1/4 inches long, 5/16-18 thread, tap No. V134-----	12
22652 F-20	Cap Screw, fillister head, socket type, 1 1/4 inches long, 3/8-16 thread, tap No. V132-----	12
22652 F-32	Cap Screw, fillister head, socket type, 2 inches long, 3/8-16 thread, tap No. V132-----	12
22653 B-8	Cap Screw, fillister head, socket type, 1/2 inch long, No. 10-32 thread, tap No. V209-----	12
22653 B-12	Cap Screw, fillister head, socket type, 3/4 inch long, 10-32 thread, tap No. V209-----	12
22653 B-16	Cap Screw, fillister head, socket type, 1 inch long, No. 10-32 thread, tap No. V209-----	12
22653 D-4	Cap Screw, fillister head, socket type, 1/4 inch long, 1/4-28 thread, tap No. V146-----	12
22653 D-8	Cap Screw, fillister head, socket type, 1/2 inch long, 1/4-28 thread, tap No. V146-----	12
22653 D-24	Cap Screw, fillister head, socket type, 1 1/2 inches long, 1/4-28 thread, tap No. V146-----	12
22653 E-12	Cap Screw, fillister head, socket type, 3/4 inch long, 5/16-24 thread, tap No. V185-----	12
22653 E-20	Cap Screw, fillister head, socket type, 1 1/4 inches long, 1 inch of thread, 5/16-24 thread, tap No. V185-----	12
22653 F-16	Cap Screw, fillister head, socket type, 1 inch long, 3/8-24 thread, tap No. V186-----	12
22653 F-20	Cap Screw, fillister head, socket type, 1 1/4 inches long, 3/8-24 thread, tap No. V186-----	12
22653 F-40	Cap Screw, fillister head, socket type, 2 1/2 inches long, 1 1/16 inches of thread, 3/8-24 thread, tap No. V186-----	12
22653 H-20	Cap Screw, fillister head, socket type, 1 1/4 inches long, 1/2-20 thread, tap No. V242-----	12
22653 J	Cap Screw, fillister head, socket type, 1/4 inch long, No. 6-40 thread, tap No. V266-----	12
22654	Shoulder Screw, socket type, fillister head, 3 3/8 inches long, with 1/2 inch diameter shoulder 2 3/4 inches long, 3/8-16 thread, tap No. V132-----	18
22655 B-7	Screw, fillister head, 7/64 inch long, No. 0-80 thread, tap No. V239 ---	10
22701	Adjusting Screw, 2 3/4 inches long, 5/16-18 thread, tap No. V134-----	8
22702	Screw Bushing, headless, 3/32 inch long, .214-32 thread, tap No. V113-----	7
22703	Thumbscrew, knurled head, 7/16 inch long, .155-40 thread, tap No. V108-----	19
22704	Screw, fillister head, 5/32 inch long, .124-50 thread, tap No. V104 ----	10
22705	Screw, capstan head, 7/32 inch long, .102-64 thread, tap No. V101-----	7
22706	Screw, headless, 7/32 inch long, .314-24 thread, tap No. V119 -----	6
22706 A	Screw, headless, 1/4 inch long, .314-24 thread, tap No. V119 -----	6
22707	Screw, hexagonal head, 57/64 inch long, .155-40 thread, tap No. V108--	14
22707 A	Screw, hexagonal head, 11/16 inch long, .155-40 thread, tap No. V108--	14
22708	Screw, fillister head, 1 13/32 inches long, .155-40 thread, tap No. V108-----	11
22710	Screw, fillister head, 9/32 inch long, .182-40 thread, tap No. V109 ----	9
22711	Screw, fillister head, 7/32 inch long, .182-40 thread, tap No. V109 ----	10

NUMERICAL LIST OF PARTS

<u>Part No.</u>	<u>Description</u>	<u>Page No.</u>
22712	Shoulder Screw, fillister head, 1 11/16 inches long, with 7/16 inch diameter shoulder 1 1/16 inches long, .314-24 thread, tap No. V119-----	17
22712 A	Shoulder Screw, fillister head, 29/32 inch long, with .407 inch diameter shoulder .412 inch long, 5/16-24 thread, tap No. V185 -----	17
22712 F	Shoulder Screw, fillister head, 1 9/32 inches long, with .375 inch diameter shoulder 21/32 inch long, 5/16-24 thread, tap No. V185 -----	17
22712 G	Shoulder Screw, fillister head, 27/32 inch long, with 3/8 inch diameter shoulder 15/32 inch long, 5/16-24 thread, tap No. V185 -----	17
22712 N	Shoulder Screw, fillister head, 1/2 inch long, with .374 inch diameter shoulder, .189 inch long, 5/16-24 thread, tap No. V185 -----	16
22713	Screw, capstan head, 7/16 inch long, .182-40 thread, tap No. V109-----	7
22714	Set Screw, headless, 15/32 inch long, .219-28 thread, tap No. V116 -----	7
22714 A	Screw, hexagonal head, 15/32 inch long, .219-28 thread, tap No. V116-----	7
22715	Shoulder Screw, fillister head, 3/8 inch long, with .319 inch diameter shoulder 19/64 inch long, .214-32 thread, tap No. V113 -----	16
22716	Screw, countersunk head, 9/64 inch long, .088-64 thread, tap No. V100-----	13
22716 A	Screw, countersunk head, 7/64 inch long, .088-64 thread, tap No. V100-----	13
22716 B	Screw, countersunk head, 5/64 inch long, .100-100 thread, tap No. V150-----	13
22716 D	Screw, countersunk head, 9/64 inch long, .088-64 thread, tap No. V100-----	13
22716 E	Screw, fillister head, 5/64 inch long, .100-100 thread, tap No. V150 -----	10
22716 F	Screw, countersunk head, 1/16 inch long, .073-72 thread, tap No. V151-----	13
22716 G	Screw, countersunk head, 3/16 inch long, .088-64 thread, tap No. V100-----	13
22716 H	Screw, countersunk head, 7/64 inch long, .088-64 thread, tap No. V100-----	13
22717	Screw Pin, 3/8 inch long, .129-50 thread, tap No. V104-----	7
22718	Screw, fillister head, 1 5/16 inches long under flange, .146-40 thread, tap No. V107-----	12
22719	Screw, fillister head, with sides of head flat, 13/16 inch long, .214-32 thread, tap No. V113-----	20
22720	Screw, fillister head, 3/4 inch long, with .330 inch diameter shoulder 3/16 inch long, with .146-40 thread, tap No. V107, cross hole in shoulder, .257-32 thread, tap No. V118 -----	18
22721	Screw, fillister head, 5/32 inch long, .110-50 thread, tap No. V102 -----	11
22722	Screw, capstan head, 5/16 inch long under flange, .146-40 thread, tap No. V107-----	7
22723	Screw, capstan head, 1/4 inch long, .146-40 thread, tap No. V107-----	7
22724	Shoulder Screw, fillister head, 11/32 inch long, with .159 inch diameter shoulder 5/32 inch long, .146-40 thread, tap No. V107 -----	16
22726	Shoulder Screw, fillister head, 13/64 inch long, with .249 inch diameter shoulder 5/64 inch long, .146-40 thread, tap No. V107 -----	16
22726 A	Shoulder Screw, fillister head, 5/32 inch long, with .156 inch diameter shoulder 1/32 inch long, .124-50 thread, tap No. V104 -----	16
22726 B	Shoulder Screw, fillister head, 5/32 inch long, with 3/16 inch diameter shoulder 3/64 inch long, .146-40 thread, tap No. V107 -----	16
22726 L	Shoulder Screw, fillister head, 11/32 inch long, with .129 inch diameter shoulder, 5/32 inch long, .126-40 thread, tap No. V105 -----	16
22726 M	Shoulder Screw, fillister head, 27/64 inch long, with .129 inch diameter shoulder, 15/64 inch long, .126-40 thread, tap No. V105 -----	16
22728	Thumbscrew, knurled head, 3/8 inch long, .257-32 thread, tap No. V118----	19
22728 A	Adjusting Screw, knurled head, 11/16 inch long, with 1/4 inch diameter shoulder 7/16 inch long, .182-40 thread, tap No. V109 -----	18
22729	Screw, fillister head, 27/64 inch long, .146-40 thread, tap No. V107 -----	11
22729 A	Screw, fillister head, 5/8 inch long, .146-40 thread, tap No. V107 -----	11
22729 B	Screw, fillister head, 13/16 inch long, .146-40 thread, tap No. V107 -----	11
22729 C	Screw, fillister head, 29/64 inch long, .146-40 thread, tap No. V107 -----	11
22729 D	Screw, fillister head, 33/64 inch long, .146-40 thread, tap No. V107 -----	11
22729 L	Cap Screw, socket type, 27/64 inch long, .146-40 thread, tap No. V107 -----	12
22730	Screw, fillister head, 13/64 inch long, .214-32 thread, tap No. V113 -----	10
22731	Shoulder Screw, fillister head, 1/2 inch long, with 5/32 inch diameter shoulder 3/8 inch long, .124-50 thread, tap No. V104 -----	16
22732	Shoulder Screw, fillister head, 19/32 inch long, with .103 inch diameter shoulder 25/64 inch long, .102-64 thread, tap No. V101 -----	16
22733	Set Screw, headless, 11/64 inch long, .124-50 thread, tap No. V104 -----	6

NUMERICAL LIST OF PARTS

<u>Part No.</u>	<u>Description</u>	<u>Page No.</u>
22733 A	Screw, round head, 17/64 inch long, 3/8-16 thread, tap No. V132 -----	13
22733 B	Plug Screw, fillister head, 1/4 inch long, .368-24 thread, tap No. V119 A---	12
22733 C	Screw, fillister head, 7/32 inch long, .597-32 thread, tap No. V96 -----	12
22733 D	Plug Screw, fillister head, 5/16 inch long, .869-20 thread, tap No. V97-----	12
22734	Screw, fillister head, 31/64 inch long, .088-64 thread, tap No. V100 -----	11
22734 A	Screw, fillister head, 19/32 inch long, .088-64 thread, tap No. V100 -----	11
22734 B	Screw, fillister head, 17/32 inch long, .088-64 thread, tap No. V100 -----	11
22735	Shoulder Screw, fillister head, 17/64 inch long, with .257 inch diameter shoulder 5/32 inch long, .182-40 thread, tap No. V109 -----	16
22735 A	Shoulder Screw, fillister head, 13/32 inch long, with .257 inch diameter shoulder .158 inch long, .182-40 thread, tap No. V109 -----	16
22736	Screw, capstan head, 5/64 inch long, .110-50 thread, tap No. V102-----	7
22736 A	Screw, capstan head, 7/64 inch long, .110-50 thread, tap No. V102 -----	7
22736 B	Screw, capstan head, with slot, 5/64 inch long, .110-50 thread, tap No. V102-----	7
22737	Screw, fillister head, 9/64 inch long, slotted on both ends, .124-50 thread, tap No. V104-----	10
22738	Screw, fillister head, 3/16 inch long, .088-64 thread, tap No. V100 -----	10
22738 A	Screw, fillister head, 11/32 inch long, .088-64 thread, tap No. V100 -----	11
22738 B	Screw, fillister head, 9/64 inch long, .088-64 thread, tap No. V100 -----	10
22738 C	Screw, fillister head, 17/64 inch long, .088-64 thread, tap No. V100 -----	11
22738 D	Screw, fillister head, 13/32 inch long, .088-64 thread, tap No. V100 -----	11
22738 F	Screw, fillister head, 7/64 inch long, .088-64 thread, tap No. V100 -----	10
22738 G	Screw, fillister head, 3/32 inch long, .088-64 thread, tap No. V100 -----	10
22738 H	Screw, fillister head, .100 inch long, .088-64 thread, tap No. V100 -----	10
22739	Shoulder Screw, hexagonal head, 3/8 inch long, with .200 inch diameter shoulder 11/64 inch long, .182-40 thread, tap No. V109 -----	18
22742	Shoulder Screw, fillister head, 27/64 inch long, with .273 inch diameter shoulder 5/64 inch long, .182-40 thread, tap No. V109-----	16
22743	Screw, headless, 1/8 inch long, .146-40 thread, tap No. V107 -----	6
22744	Shoulder Screw, fillister head, 27/32 inch long, with .257 inch diameter shoulder 19/64 inch long, .191-28 thread, tap No. V112 -----	17
22745	Screw, fillister head, 1/4 inch long, .126-40 thread, tap No. V105 -----	11
22746	Shoulder Screw, fillister head, 17/64 inch long, with 15/64 inch diameter shoulder 9/64 inch long, .182-40 thread, tap No. V109-----	16
22747	Screw, fillister head, 23/64 inch long, .124-50 thread, tap No. V104 -----	11
22747 A	Screw, fillister head, 5/8 inch long, .124-50 thread, tap No. V104 -----	11
22747 B	Screw, fillister head, 1/2 inch long, .124-50 thread, tap No. V104 -----	11
22748	Screw, fillister head, 7/32 inch long under flange, .146-40 thread, tap No. V107-----	12
22748 A	Screw, fillister head, 11/64 inch long under flange, .146-40 thread, tap No. V107-----	12
22750	Screw, fillister head, 3/4 inch long, .257-32 thread, tap No. V118 -----	10
22751	Spot Screw, headless, 17/32 inch long, No. 14-20 thread, tap No. V130 -----	6
22752	Set Screw, headless, 15/64 inch long, with .100 inch diameter pilot 7/64 inch long, .214-32 thread, tap No. V113 -----	7
22752 A	Set Screw, headless, 15/64 inch long, with .070 inch diameter pilot 7/64 inch long, .214-32 thread, tap No. V113 -----	7
22752 B	Screw, capstan head, 5/16 inch long, .257-32 thread, tap No. V118-----	7
22752 C	Set Screw, headless, 11/32 inch long, with .100 inch diameter pilot 5/64 inch long, .214-32 thread, tap No. V113 -----	7
22754	Screw, countersunk head, 5/8 inch long, .257-32 thread, tap No. V118-----	13
22755	Shoulder Screw, fillister head, 9/16 inch long, with .162 inch diameter shoulder 3/8 inch long, .155-40 thread, tap No. V108-----	11
22756	Wing Screw, 13/64 inch long, .182-40 thread, tap No. V109-----	20
22756 A	Wing Screw, 9/32 inch long, .182-40 thread, tap No. V109-----	20
22757	Screw, fillister head, 1/2 inch long, .182-40 thread, tap No. V109 -----	10
22757 A	Screw, countersunk head, 13/32 inch long, .183-32 left hand thread, tap No. V111-----	10
22757 B	Shoulder Screw, fillister head, 13/32 inch long, with .222 inch diameter shoulder 5/16 inch long, .182-40 thread, tap No. V109 -----	16

NUMERICAL LIST OF PARTS

<u>Part No.</u>	<u>Description</u>	<u>Page No.</u>
22757 C	Screw, countersunk head, 13/32 inch long, .183-32 left hand thread, tap No. V111-----	13
22757 D	Screw, countersunk head, 13/32 inch long, .183-32 left hand thread, tap No. V111-----	13
22757 E	Screw, countersunk head, 21/64 inch long including .140 inch diameter pilot 3/64 inch long, .183-32 thread, tap No. V110-----	10
22757 F	Screw, fillister head, 3/16 inch long, .183-32 left hand thread, tap No. V111-----	10
22758	Shoulder Screw, fillister head, 15/64 inch long, with .219 inch diameter shoulder 7/64 inch long, .182-40 thread, tap No. V109-----	16
22758 A	Shoulder Screw, fillister head, 33/64 inch long, with .226 inch diameter shoulder 1/4 inch long, .183-32 left hand thread, tap No. V111-----	16
22758 B	Shoulder Screw, fillister head, 21/64 inch long, with .217 inch diameter shoulder 5/64 inch long, .182-40 thread, tap No. V109-----	16
22758 C	Shoulder Screw, fillister head, 15/64 inch long, with .217 inch diameter shoulder, .070 inch long, .182-40 thread, tap No. V109-----	16
22758 E	Shoulder Screw, fillister head, 5/16 inch long, with .250 inch diameter shoulder 1/8 inch long, .182-40 thread, tap No. V109-----	16
22758 F	Shoulder Screw, fillister head, 13/32 inch long, with .250 inch diameter shoulder .159 inch long, .182-40 thread, tap No. V109-----	16
22758 G	Shoulder Screw, fillister head, 17/32 inch long, with .312 inch diameter shoulder .287 inch long, .183-32 left hand thread, tap No. V111-----	16
22758 H	Shoulder Screw, fillister head, 1/2 inch long, with .188 inch diameter shoulder 7/32 inch long, .182-40 thread, tap No. V109-----	10
22759	Screw, hexagonal head, 19/32 inch long, .257-32 thread, tap No. V118-----	14
22759 A	Screw, hexagonal head, 1 19/64 inches long, .257-32 thread, tap No. V118 --	14
22760	Shoulder Screw, fillister head, 15/64 inch long, with .188 inch diameter shoulder .086 inch long, .146-40 thread, tap No. V107-----	16
22760 A	Shoulder Screw, fillister head, 13/64 inch long, with 3/16 inch diameter shoulder .086 inch long, .146-40 thread, tap No. V107-----	16
22760 B	Shoulder Screw, fillister head, 13/32 inch long, with 3/16 inch diameter shoulder 1/16 inch long, .146-40 thread, tap No. V107-----	16
22760 C	Shoulder Screw, fillister head, 3/8 inch long, with .187 inch diameter shoulder 1/8 inch long, .146-40 thread, tap No. V107-----	18
22761	Shoulder Screw, fillister head, 23/32 inch long, with .281 inch diameter eccentric shoulder 1/8 inch long, .214-32 thread, tap No. V113-----	18
22762	Shoulder Screw, fillister head, 3/8 inch long, with .222 inch diameter shoulder 7/32 inch long, .182-40 thread, tap No. V109-----	18
22764	Spot Screw, headless, 7/32 inch long, .182-40 thread, tap No. V109-----	6
22764 A	Spot Screw, headless, 9/32 inch long, .182-40 thread, tap No. V109-----	6
22764 B	Spot Screw, headless, 15/32 inch long, .182-40 thread, tap No. V109-----	6
22765	Shoulder Screw, hexagonal head, 23/64 inch long, with .185 inch diameter shoulder .072 inch long, .146-40 thread, tap No. V107-----	14
22766	Screw, countersunk head, 7/32 inch long, .146-40 thread, tap No. V107-----	13
22767	Screw, fillister head, 7/16 inch long, .102-64 thread, tap No. V101-----	11
22767 A	Screw, fillister head, 1/2 inch long, .102-64 thread, tap No. V101-----	11
22768	Screw, fillister head, 7/32 inch long, .124-50 thread, tap No. V104-----	10
22768 A	Screw, fillister head, 7/64 inch long, .124-50 thread, tap No. V104-----	10
22768 B	Screw, fillister head, 1/4 inch long, .124-50 thread, tap No. V104-----	10
22768 L	Screw, fillister head, 7/32 inch long, (same as screw No. 22768 except left thread) .124-50 thread, tap No. V214-----	10
22769	Screw, countersunk head, 17/32 inch long, .182-40 thread, tap No. V109----	13
22769 A	Screw, countersunk head, 7/8 inch long, .182-40 thread, tap No. V109-----	13
22770	Shoulder Screw, fillister head, 3/4 inch long, with .160 inch diameter shoulder 19/32 inch long, .155-40 thread, tap No. V108-----	16
22772	Shoulder Screw, fillister head, 5/16 inch long, with .173 inch diameter shoulder 1/16 inch long, .124-50 thread, tap No. V104-----	16
22772 A	Shoulder Screw, fillister head, 1/4 inch long, with .187 inch diameter shoulder .126 inch long, .146-40 thread, tap No. V107-----	16
22773	Shoulder Screw, fillister head, 1/2 inch long, with 7/32 inch diameter shoulder 1/4 inch long, .182-40 thread, tap No. V109-----	16

NUMERICAL LIST OF PARTS

Part No.	Description	Page No.
22773 A	Shoulder Screw, fillister head, 19/32 inch long, with .184 inch diameter shoulder 1/4 inch long, .182-40 thread, tap No. V109 -----	16
22773 B	Shoulder Screw, fillister head, 1 5/32 inches long, with .184 inch diameter shoulder 7/8 inch long, .182-40 thread, tap No. V109 -----	11
22774	Thumbscrew, knurled head, 1/2 inch long, .182-40 thread, tap No. V109 ---	20
22775	Screw, fillister head, 13/32 inch long, .146-40 thread, tap No. V107 -----	10
22775 A	Screw, fillister head, 13/32 inch long, .146-40 thread, tap No. V107 -----	10
22776	Shoulder Screw, fillister head, 1/2 inch long, with .220 inch diameter flattened shoulder 3/8 inch long, .182-40 thread, tap No. V109-----	18
22777	Shoulder Screw, fillister head, 55/64 inch long, with .257 inch diameter shoulder .541 inch long, .214-32 thread, tap No. V113 -----	17
22777 A	Shoulder Screw, fillister head, 1 3/32 inches long, with .257 inch diameter shoulder .541 inch long, .214-32 thread, tap No. V113 -----	17
22777 B	Shoulder Screw, hexagonal head, 7/8 inch long, with 1/4 inch diameter shoulder 17/32 inch long, .214-32 thread, tap No. V113 -----	18
22778	Shoulder Screw, fillister head, 29/64 inch long, with .220 inch diameter shoulder .223 inch long, .182-40 thread, tap No. V109 -----	16
22779	Shoulder Screw, fillister head, 1 3/32 inches long, with .319 inch diameter shoulder 23/32 inch long, .214-32 thread, tap No. V113 -----	17
22780	Screw, fillister head, 1 5/8 inches long under flange, .214-32 thread, tap No. V113-----	12
22781	Screw, hexagonal head, 1/4 inch long, .124-50 thread, tap No. V104-----	14
22783	Screw, fillister head, 9/32 inch long over-all, 7/64 inch pilot, .124-50 thread, tap No. V104-----	7
22784	Screw, fillister head, 3/32 inch long, .110-50 thread, tap No. V102 -----	10
22784 A	Screw, fillister head, 3/32 inch long, .110-50 thread, tap No. V102 -----	10
22784 E	Screw, fillister head, 9/64 inch long, .110-50 thread, tap No. V102 -----	10
22784 F	Screw, fillister head, 1/4 inch long, .110-50 thread, tap No. V102 -----	10
22784 K	Shoulder Screw, fillister head, 1/2 inch long, with 1/4 inch pilot, No. 6-32 thread, tap No. V128-----	7
22786	Shoulder Screw, fillister head, 3/8 inch long, with .116 inch diameter shoulder 9/32 inch long, .102-64 thread, tap No. V101 -----	16
22787	Shoulder Screw, fillister head, 13/32 inch long, with .220 inch diameter shoulder 7/32 inch long, .182-40 thread, tap No. V109 -----	16
22787 B	Shoulder Screw, fillister head, 11/32 inch long, with .240 inch diameter shoulder 7/32 inch long, .182-40 thread, tap No. V109 -----	16
22787 D	Shoulder Screw, fillister head, 27/64 inch long, with .328 inch diameter shoulder .229 inch long, .182-40 thread, tap No. V109 -----	16
22788	Screw, hexagonal head, 29/32 inch long, .314-24 thread, tap No. V119-----	14
22788 G	Screw, hexagonal head, 3 33/64 inches long, .308-24 thread -----	(-)
22789	Thumbscrew, knurled head, 1 3/16 inches long, .219-28 thread, tap No. V116-----	19
22789 A	Thumbscrew, knurled head, 1 15/16 inches long, .257-32 thread, tap No. V118-----	19
22789 B	Thumbscrew, knurled head, 1 3/4 inches long over-all, with 1/4 inch long pilot, .257-32 thread, tap No. V118-----	7
22790	Screw, countersunk head, 13/32 inch long, with fluted side, .182-40 thread, tap No. V109-----	13
22791	Screw Pin, 1 7/32 inches long, .191-28 thread, tap No. V112 -----	9
22791 A	Screw Pin, headless, 1 1/8 inches long over-all, cone point, 5/16 inch length of thread, .146-40 thread, tap No. V107 -----	9
22791 B	Screw Pin, headless, 1 9/32 inches long over-all, cone point, 5/16 inch length of thread, .146-40 thread, tap No. V107 -----	9
22791 C	Screw Pin, headless, 1 13/32 inches long over-all, cone point, 5/16 inch length of thread, .146-40 thread, tap No. V107 -----	9
22791 D	Screw Pin, headless, 1 1/2 inches long, with .156 inch diameter pilot 3/4 inch long, .214-32 thread, tap No. V113 -----	9
22791 E	Screw Pin, headless, 7/8 inch long, with .118 inch diameter pilot 5/8 inch long, .146-40 thread, tap No. V107 -----	9

(-) A dash in the "Page No." column denotes the absence of an illustration.

NUMERICAL LIST OF PARTS

Part No.	<u>Description</u>	Page No.
22791 F	Screw Pin, headless, 1 11/16 inches long, with .139 inch diameter pilot 1 inch long, .191-28 thread, tap No. V112-----	9
22791 G	Screw Pin, headless, 1 1/8 inches long, with .156 inch diameter pilot 7/16 inch long, .214-32 thread, tap No. V113 -----	9
22792	Shoulder Screw, hexagonal head, 1/2 inch long, with .250 inch diameter shoulder 5/32 inch long, .183-32 thread, tap No. V110 -----	18
22792 A	Shoulder Screw, hexagonal head, 25/64 inch long, with 1/4 inch diameter shoulder 1/64 inch long, .183-32 thread, tap No. V110 -----	18
22793	Shoulder Screw, fillister head, 45/64 inch long, with .145 inch diameter shoulder, 17/32 inch long, .124-50 thread, tap No. V104 -----	16
22794	Shoulder Screw, fillister head, 51/64 inch long, with .148 inch diameter shoulder 5/8 inch long, .124-50 thread, tap No. V104 -----	16
22794 A	Shoulder Screw, fillister head, 27/32 inch long, with .151 inch diameter shoulder 11/16 inch long, .124-50 thread, tap No. V104 -----	17
22794 B	Screw, fillister head, 53/64 inch long, .124-50 thread, tap No. V104 -----	11
22794 C	Shoulder Screw, fillister head, 5/8 inch long, with .151 inch diameter shoulder 15/32 inch long, .124-50 thread, tap No. V104 -----	16
22795	Screw, fillister head, 25/64 inch long under flange, .146-40 thread, tap No. V107-----	12
22796	Screw, fillister head, 1/16 inch long, .146-40 thread, tap No. V107 -----	10
22797	Screw, fillister head, 9/32 inch long, .110-50 thread, tap No. V102 -----	11
22798	Screw, fillister head, 5/64 inch long, .088-64 thread, tap No. V100 -----	10
22798 A	Screw, fillister head, 3/16 inch long, .088-64 thread, tap No. V100 -----	10
22798 B	Screw, fillister head, 5/32 inch long, .088-64 thread, tap No. V100 -----	10
22799	Shoulder Screw, fillister head, 37/64 inch long, with .109 inch diameter shoulder 13/32 inch long, .102-64 thread, tap No. V101 -----	16
22799 A	Hinge Screw, headless, 33/64 inch long, .088-64 thread, tap No. V100-----	8
22799 B	Hinge Screw, headless, 37/64 inch long, .088-64 thread, tap No. V100-----	8
22799 C	Hinge Screw, headless, 49/64 inch long, .088-64 thread, tap No. V100-----	8
22799 D	Hinge Screw, headless, 49/64 inch long, .124-50 thread, tap No. V104-----	8
22799 E	Hinge Screw, headless, 41/64 inch long, .088-64 thread, tap No. V100-----	8
22799 F	Hinge Screw, headless, 5/16 inch long, .088-64 thread, tap No. V100-----	8
22799 G	Hinge Screw, headless, 25/64 inch long, .088-64 thread, tap No. V100-----	8
22799 H	Hinge Screw, headless, 29/64 inch long, .088-64 thread, tap No. V100-----	8
22799 J	Hinge Screw, headless, 57/64 inch long, .124-50 thread, tap No. V104-----	8
22799 K	Hinge Screw, headless, 31/32 inch long, .124-50 thread, tap No. V104-----	8
22799 L	Hinge Screw, headless, 9/16 inch long, .124-50 thread, tap No. V104-----	8
22799 M	Shoulder Screw, headless, 7/8 inch long, with .217 inch diameter shoulder 19/32 inch long, .182-40 thread, tap No. V109 -----	8
22799 N	Screw Pin, headless, 11/64 inch long, .088-64 thread, tap No. V100-----	8
22799 P	Hinge Screw, headless, 29/64 inch long, .088-64 thread, tap No. V100-----	8
22799 Q	Hinge Screw, headless, 7/8 inch long, .124-50 thread, tap No. V104-----	8
22799 R	Hinge Screw, headless, 33/64 inch long, .088-64 thread, tap No. V100-----	8
22799 S	Hinge Screw, headless, 19/32 inch long, .102-64 thread, tap No. V101-----	8
22799 T	Screw Pin, headless, 1 1/8 inches long, .182-40 thread, tap No. V109 -----	8
22799 U	Hinge Screw, headless, 15/64 inch long, .088-64 thread, tap No. V100-----	8
22801	Hinge Screw, headless, 5/32 inch long, .124-50 thread, tap No. V104-----	8
22802	Shoulder Screw, headless, 29/32 inch long, with 3/8 inch diameter shoulder 33/64 inch long, .257-32 thread, tap No. V118 -----	9
22802 A	Shoulder Screw, headless, 1/2 inch long, with .436 inch diameter shoulder, 11/32 inch long, .214-32 thread, tap No. V113 -----	9
22804	Screw, fillister head, 11/32 inch long, .124-50 thread, tap No. V104 -----	10
22805	Screw, countersunk head, 1/4 inch long, .182-40 thread, tap No. V109-----	13
22806	Screw, fillister head, 1 9/32 inches long, .257-32 thread, tap No. V118-----	11
22806 A	Screw, fillister head, 21/32 inch long, .257-32 thread, tap No. V118 -----	11
22806 G	Screw, fillister head, socket type, 1 1/4 inches long, .257-32 thread, tap No. V118-----	12
22807	Screw, countersunk head, 5/16 inch long, .214-32 thread, tap No. V113-----	13
22809 A	Shoulder Screw, fillister head, 3/8 inch long, with double shoulder .187 inch diameter .106 inch long and .156 inch diameter .148 inch long, .124-50 thread, tap No. V104-----	18
22810	Cap Screw, fillister head, 1 inch long, 5/16-18 thread, tap No. V134 -----	11

NUMERICAL LIST OF PARTS

Part No.	Description	Page No.
22811	Screw, hexagonal head, 3/4 inch long, .257-32 thread, tap No. V118-----	14
22811 B	Screw, hexagonal head, 3/4 inch long, .257-32 thread, tap No. V118-----	14
22812	Shoulder Screw, button head, 23/64 inch long, with .174 inch diameter shoulder .147 inch long, .124-50 thread, tap No. V104-----	16
22813	Set Screw, headless, 1/4 inch long, No. 10-24 thread, tap No. V208-----	6
22814	Screw, fillister head, 1 7/32 inches long, 5/16-18 thread, tap No. V134-----	11
22814 B	Screw, fillister head, 3/4 inch long, 5/16-18 thread, tap No. V134-----	11
22815	Spot Screw, headless, 5/8 inch long, 5/16-18 thread, tap No. V134-----	6
22817	Shoulder Screw, hexagonal head, 1 11/16 inches long, with .562 inch diameter shoulder 11/16 inch long, 1/2-13 thread, tap No. V136-----	15
22817 A	Shoulder Screw, hexagonal head, 1 5/16 inches long, with .435 inch diameter shoulder .815 inch long, .368-24 thread, tap No. V119 A-----	18
22817 B	Shoulder Screw, hexagonal head, 1 21/32 inches long, has special shoulder 7/16 inch diameter 1/4 inch long, 5/16-18 thread, tap No. V134---	18
22817 C	Shoulder Screw, hexagonal head, 15/16 inch long, with .500 inch diameter shoulder, .531 inch long, .368-24 thread, tap No. V119 A-----	18
22818	Screw, button head, 5/16 inch long, with .155 inch diameter shoulder 3/32 inch long, .146-40 thread, tap No. V107-----	13
22819	Screw, fillister head, .132 inch long, .124-50 thread, tap No. V104-----	11
22820	Cap Screw, hexagonal head, 1 3/4 inches long, 3/8-16 thread, tap No. V132-----	14
22820 H	Screw, hexagonal head, 1 inch long, 5/16-24 thread, tap No. V185-----	18
22821	Screw, hexagonal head, 1 3/4 inches long, 1/2-13 thread, tap No. V136-----	14
22822	Hinge Screw, headless, 1 inch long, 5/16-24 thread, tap No. V185-----	7
22823	Screw, slotted, countersunk hexagonal head, 37/64 inch long, 1/4-28 thread, tap No. V146-----	13
22823 A	Screw, slotted, countersunk hexagonal head, 11/16 inch long, 1/4-28 thread, tap No. V146-----	13
22823 B	Screw, slotted, countersunk hexagonal head, 1 1/4 inches long, 1/4-28 thread, tap No. V146-----	13
22823 C	Screw, slotted, countersunk hexagonal head, 1 1/16 inches long, 1/4-28 thread, tap No. V146-----	13
22824	Screw, hexagonal head, 3/16 inch long, .183-32 thread, tap No. V110-----	14
22824 A	Screw, hexagonal head, 7/64 inch long, .182-40 thread, tap No. V109-----	14
22825	Screw, round head, 9/64 inch long, .146-40 thread, tap No. V107-----	13
22826	Screw, round head, 3/4 inch long, .155-40 thread, tap No. V108-----	13
22827	Cap Screw, hexagonal head, 2 1/4 inches long, 1/2-13 thread, tap No. V136-----	(-)
22828	Shoulder Screw, hexagonal head, 9/32 inch long, with 5/16 inch diameter shoulder 1/32 inch long, .182-40 thread, tap No. V109-----	18
22829	Screw, fillister head, 1/4 inch long, .182-40 thread, tap No. V109-----	10
22830	Screw, fillister head, 3/16 inch long, .182-40 thread, tap No. V109-----	10
22831	Screw, hexagonal head, 4 inches long, 5/8-11 thread, tap No. V137-----	(-)
22832	Shoulder Screw, hexagonal head, 9/16 inch long, with .190 inch diameter shoulder 1/8 inch long, .182-40 thread, tap No. V109-----	18
22832 G	Screw, hexagonal head, 1 1/8 inches long, with .319 inch diameter shoulder 11/16 inch long, .214-32 thread, tap No. V113-----	18
22833	Screw, fillister head, 15/32 inch long, .146-40 thread, tap No. V107-----	11
22834	Adjusting Screw, fillister head, 13/32 inch long under flange, .124-50 thread, tap No. V104-----	8
22835	Screw, fillister head, 3/4 inch long, .182-40 thread, tap No. V109-----	11
22836	Screw, fillister head, 1/4 inch long, .214-32 thread, tap No. V113-----	10
22837	Thumbscrew, knurled head, 11/32 inch long, .182-40 thread, tap No. V109--	19
22837 A	Thumbscrew, knurled head, 29/32 inch long, .182-40 thread, tap No. V109--	20
22837 B	Screw Pin, 1 1/8 inches long, .214-32 thread, tap No. V113-----	8
22837 C	Thumbscrew, knurled, 29/32 inch long, with 5/16 inch diameter shoulder 11/32 inch long, .182-40 thread, tap No. V109-----	18
22839	Screw, fillister head, 13/32 inch long, .214-32 thread, tap No. V113-----	10
22839 A	Screw, fillister head, 9/32 inch long, .214-32 thread, tap No. V113-----	10
22839 B	Screw, fillister head, 7/32 inch long, .214-32 thread, tap No. V113-----	10

(-) A dash in the "Page No." column denotes the absence of an illustration.

NUMERICAL LIST OF PARTS

<u>Part No.</u>	<u>Description</u>	<u>Page No.</u>
22839 C	Screw, fillister head, 5/16 inch long, .214-32 thread, tap No. V113 -----	10
22839 D	Screw, fillister head, 13/32 inch long, .214-32 thread, tap No. V113 -----	10
22839 E	Screw, fillister head, 23/32 inch long, .214-32 thread, tap No. V113 -----	11
22839 F	Screw, fillister head, 7/8 inch long, .214-32 thread, tap No. V113 -----	11
22840	Adapter Screw, headless, 3/8 inch long, .182-40 internal thread, tap No. V109, .414-16 external thread, tap No. V123 -----	7
22840 A	Screw, headless, 7/16 inch long, .146-40 thread, tap No. V107 -----	6
22840 B	Adapter Screw, headless, 3/8 inch long, .216-22 internal thread, tap No. V115, .416-16 external thread, tap No. V123 -----	7
22840 C	Adjusting Screw, headless, 1 5/16 inches long, .146-40 thread, tap No. V107-----	8
22841	Thumbscrew, knurled, 41/64 inch long under flange, .182-40 thread, tap No. V109-----	20
22841 A	Screw Post, hexagonal, 1 1/4 inches long, internal thread .182-40, 11/16 inch deep, tap No. V109, external thread .182-40, tap No. V109-----	8
22841 B	Screw Post, hexagonal, 3 5/8 inches long, internal thread .214-32, 9/16 inch deep, tap No. V113, external thread 7/16-27, tap No. V160-----	8
22841 C	Screw Post, hexagonal, 1 19/32 inches long, internal thread .214-32 9/16 inch deep, tap No. V113, external thread .257-32, tap No. V118-----	8
22841 E	Adapter Stud, 3 5/8 inches long, internal thread .214-32, 9/16 inch deep, tap No. V113, external thread 7/16-27, tap No. V160 -----	8
22841 F	Table Board Adapter, 7/8 inch hexagonal, 1 5/8 inches long, with 3/8-16 internal thread, both ends, tap No. V132 -----	8
22841 H	Adjusting Screw, 1 1/16 inches long over-all, 3/8 inch hexagonal head, 1/2 inch long, with .217-32 left hand internal thread, tap No. V114, .214-32 external thread, tap No. V113-----	8
22842	Screw, fillister head, 7/8 inch long, .214-32 thread, tap No. V113 -----	10
22843	Thumbscrew, knurled, 1 1/16 inches long, .224-32 thread, tap No. V117-----	20
22843 A	Screw, headless, 1 1/2 inches long, .224-32 thread, tap No. V117-----	6
22844	Screw Pin, headless, 2 1/2 inches long, with .125 inch diameter pilot 1 1/2 inches long, .257-32 thread, tap No. V118-----	9
22845	Shoulder Screw, headless, 15/32 inch long over-all, with .156 inch diameter shoulder 9/32 inch long, .124-50 thread, tap No. V104 -----	9
22845 A	Shoulder Screw, headless, .259 inch long, with .156 inch diameter shoulder 1/8 inch long, .124-50 thread, tap No. V104 -----	9
22845 B	Shoulder Screw, headless, 7/32 inch long, with .156 inch diameter shoulder 3/32 inch long, .124-50 thread, tap No. V104 -----	9
22845 C	Shoulder Screw, headless, 1/2 inch long, with .257 inch diameter shoulder 17/64 inch long, .214-32 thread, tap No. V113 -----	9
22845 D	Shoulder Screw, headless, 31/32 inch long, with .319 inch diameter shoulder 17/32 inch long, .214-32 thread, tap No. V113 -----	9
22845 E	Shoulder Screw, headless, 23/64 inch long, with .156 inch diameter shoulder 11/64 inch long, .124-50 thread, tap No. V104 -----	9
22845 F	Shoulder Screw, headless, 1/2 inch long, with .319 inch diameter shoulder 17/64 inch long, .255-40 thread, tap No. V92 -----	9
22845 G	Screw, fillister head, 5/32 inch long, .182-40 thread, tap No. V109 -----	11
22845 H	Screw, fillister head, 13/64 inch long, dog point, .126-40 thread, tap No. V105-----	11
22845 J	Shoulder Screw, headless, 27/64 inch long, with .180 inch diameter shoulder, .281 inch long, .146-40 thread, tap No. V107 -----	9
22845 K	Shoulder Screw, headless, 31/32 inch long over-all, with .406 inch diameter shoulder 17/32 inch long, .214-32 thread, tap No. V113 -----	9
22847	Screw, fillister head, 1 1/4 inches long, .314-24 thread, tap No. V119-----	10
22848	Screw, round head, 11/32 inch long, .182-40 thread, tap No. V109 -----	13
22849	Screw, round head, 11/32 inch long, .146-40 thread, tap No. V107 -----	13
22849 A	Screw, round head, 1/4 inch long, .146-40 thread, tap No. V107 -----	13
22850	Shoulder Screw, fillister head, 47/64 inch long, with .318 inch diameter shoulder .137 inch long, .214-32 thread, tap No. V113 -----	16
22850 A	Shoulder Screw, fillister head, 47/64 inch long, with .317 inch diameter shoulder .137 inch long, .224-32 thread, tap No. V117 -----	16
22851	Screw, fillister head, 1 3/32 inches long, .088-64 thread, tap No. V100-----	12
22852	Screw, hexagonal head, 1/2 inch long, .214-32 thread, tap No. V113-----	14

NUMERICAL LIST OF PARTS

Part No.	Description	Page No.
22852 A	Screw, slotted hexagonal head, 19/32 inch long, special steel, .214-32 thread, tap No. V113-----	14
22853	Shoulder Screw, hexagonal head, 47/64 inch long, with .248 inch diameter shoulder, 9/32 inch long, .182-40 thread, tap No. V109-----	18
22853 A	Shoulder Screw, hexagonal head, 9/16 inch long, with .248 inch diameter shoulder 5/64 inch long, .182-40 thread, tap No. V109 -----	18
22854	Shoulder Screw, fillister head, 23/32 inch long, with .312 inch diameter shoulder .340 inch long, .257-32 thread, tap No. V118 -----	16
22854 A	Shoulder Screw, fillister head, 7/8 inch long, with 3/8 inch diameter shoulder .378 inch long, .257-32 thread, tap No. V118 -----	17
22854 C	Shoulder Screw, fillister head, 1 5/32 inches long, with .407 inch diameter shoulder .722 inch long, 5/16-24 thread, tap No. V185 -----	17
22854 D	Shoulder Screw, fillister head, 1 1/16 inches long, with .407 inch diameter shoulder 23/32 inch long, 5/16-24 thread, tap No. V185 -----	17
22856	Shoulder Screw, round head, 11/32 inch long, with .124 inch diameter shoulder .273 inch long, .088-64 thread, tap No. V100 -----	16
22857	Shoulder Screw, fillister head, 1 1/16 inches long, with .319 inch diameter shoulder .378 inch long, .257-32 thread, tap No. V118 -----	18
22857 A	Shoulder Screw, hexagonal head, 25/32 inch long, with .319 inch diameter shoulder .378 inch long, .257-32 thread, tap No. V118 -----	18
22857 B	Shoulder Screw, slotted hexagonal head, 31/32 inch long, with 3/8 inch diameter shoulder .377 inch long, .257-32 thread, tap No. V118 -----	18
22861	Screw, fillister head, 1 1/16 inches long, .214-32 thread, tap No. V113-----	10
22861 A	Screw, fillister head, 23/32 inch long, .214-32 thread, tap No. V113 -----	11
22861 D	Screw, fillister head, 19/32 inch long, .214-32 thread, tap No. V113 -----	11
22862	Thumbscrew, knurled head, 11/32 inch long under flange, .124-50 thread, tap No. V104-----	12
22863	Adjusting Screw, 7/16 inch long over-all, 1/4 inch long under flange, .124-50 thread, tap No. V104-----	8
22863 A	Screw Pin, 5/8 inch long under flange, .146-40 thread, tap No. V107 -----	8
22863 B	Adjusting Screw, 13/32 inch long under flange, .146-40 thread, tap No. V107-----	8
22864	Screw, hexagonal head, 3/4 inch long, .110-50 thread, tap No. V102-----	14
22865	Shoulder Screw, fillister head, 1 7/16 inches long, with .407 inch diameter shoulder 15/16 inch long, .368-24 thread, tap No. V119 A -----	17
22865 A	Shoulder Screw, fillister head, 1 3/4 inches long, with .407 inch diameter shoulder 1 5/16 inches long, .368-24 thread, tap No. V119 A-----	17
22866	Screw, hexagonal head, 11/32 inch long, .257-32 thread, tap No. V118-----	14
22866 G	Screw, hexagonal head, 5/16 inch long, .255-40 thread, tap No. V92-----	14
22867	Shoulder Screw, fillister head, 19/32 inch long, with .187 inch diameter shoulder 9/32 inch long, .182-40 thread, tap No. V109 -----	17
22868	Shoulder Screw, hexagonal head, 27/32 inch long, with .157 inch diameter shoulder 9/32 inch long, .155-40 thread, tap No. V108 -----	14
22868 A	Screw, hexagonal head, 27/32 inch long, with .157 inch diameter shoulder 9/16 inch long, .155-40 thread, tap No. V108 -----	18
22870	Shoulder Screw, headless, 1 1/16 inches long, with 5/16 inch diameter shoulder 45/64 inch long, .257-32 thread, tap No. V118 -----	9
22870 A	Screw, fillister head without slot, 1 31/32 inches long, .146-40 thread, tap No. V107-----	12
22871	Screw, fillister head, 2 3/4 inches long, 5/16-18 thread, tap No. V134-----	12
22872	Screw, fillister head, 3/8 inch long, .216-22 thread, tap No. V115 -----	10
22873	Adjusting Screw, knurled head, 1/2 inch long under knurled flange, .146-40 thread, tap No. V107-----	19
22873 A	Adjusting Screw, knurled head, 5/8 inch long under flange, .146-40 thread, tap No. V107-----	19
22873 B	Adjusting Screw, knurled head, 27/32 inch long under flange, .146-40 thread, tap No. V107-----	19
22874	Screw, fillister head, 13/16 inch long, .182-40 thread, tap No. V109 -----	11
22874 C	Screw, fillister head, 43/64 inch long, .182-40 thread, tap No. V109 -----	11
22874 D	Shoulder Screw, fillister head, 23/32 inch long under flange, with 1/4 inch diameter shoulder flattened to .195 inch across flats 7/64 inch long, .182-40 thread, tap No. V109 -----	17

NUMERICAL LIST OF PARTS

<u>Part No.</u>	<u>Description</u>	<u>Page No.</u>
22874 E	Screw, fillister head, 1 inch long, .182-40 thread, tap No. V109 -----	11
22874 F	Screw, fillister head, 1 3/16 inches long, .182-40 thread, tap No. V109-----	11
22875	Screw, fillister head, 9/32 inch long, No. 8-32 thread, tap No. V129 -----	10
22876	Screw, fillister head, 1/2 inch long, No. 6-40 thread, tap No. V266 -----	11
22877	Shoulder Screw, fillister head, 13/64 inch long, with .185 inch diameter shoulder 5/64 inch long, No. 6-36 thread -----	16
22878	Set Screw, headless, 3/16 inch long, 3/16-32 thread, tap No. V311-----	6
22879	Shoulder Screw, fillister head, 5 inches long, with .437 inch diameter shoulder .705 inch long, .314-24 thread, tap No. V119-----	18
22880	Spot Screw, fillister head, 5/16 inch long, .182-40 thread, tap No. V109 ----	11
22881	Screw, hexagonal head, 15/16 inch long, .214-32 thread, tap No. V113-----	14
22881 A	Screw, hexagonal head, 7/16 inch long, No. 10-32 thread, tap No. V209-----	14
22882	Screw, hexagonal head, 3/8 inch long, .214-32 thread, tap No. V113-----	14
22882 A	Screw, hexagonal head, 13/16 inch long, .214-32 thread, tap No. V113-----	14
22882 B	Spot Screw, hexagonal head, 7/16 inch long, .255-40 thread, tap No. V92 ---	14
22883	Screw, fillister head, 7/32 inch long, brass, .510-24 thread, tap No. V124-----	12
22883 A	Plug Screw, fillister head, 5/32 inch long, .510-24 thread, tap No. V124----	12
22883 H	Adapter Stud, 9/16 inch long, internal thread 5/16-18, tap No. V134, external thread .510-24, tap No. V124-----	7
22884	Screw, fillister head, 5/16 inch long, .255-40 thread, tap No. V92 -----	10
22884 A	Screw, fillister head, 9/16 inch long, .255-40 thread, tap No. V92 -----	10
22884 B	Spot Screw, fillister head, 43/64 inch long, .255-40 thread, tap No. V92 ----	14
22885	Adapter Plug Screw, 1/4 inch long, .214-32 internal thread, tap No. V113, .368-24 external thread, tap No. V119 A-----	7
22886	Plug Screw, headless, 5/16 inch long, .216-22 thread, tap No. V115-----	6
22888	Screw, countersunk head, 59/64 inch long, .214-32 thread, tap No. V113----	13
22888 A	Screw, countersunk head, 61/64 inch long, .217-32 left hand thread, tap No. V114-----	13
22889 A	Adapter Plug Screw, 3/8 inch long, with .182-40 internal thread, tap No. V109, .368-24 external thread, tap No. V119 A -----	7
22889 B	Adapter Plug Screw, fillister head, 3/8 inch long, .216-22 internal thread, tap No. V115, .368-24 external thread, tap No. V119 A -----	7
22889 C	Adapter Plug Screw, headless, 9/16 inch long, with pilot .300 inch diameter 1/4 inch long, internal thread .182-40, tap No. V109, external thread 368-24, tap No. V119 A-----	7
22889 D	Adapter Plug Screw, headless, 5/8 inch long, internal thread .182-40, tap No. V109, external thread .368-24, tap No. V119 A -----	7
22890	Shoulder Screw, fillister head, 31/32 inch long, with .437 inch diameter shoulder .439 inch long, .368-24 left hand thread, tap No. V95-----	18
22890 A	Shoulder Screw, fillister head, 11/16 inch long, with .437 inch diameter shoulder .180 inch long, .368-24 left hand thread, tap No. V95-----	17
22891	Screw, fillister head, 15/32 inch long, .257-32 thread, tap No. V118 -----	11
22891 A	Adapter Screw, fillister head, 7/32 inch long, with internal .110-50 thread in head, tap No. V102, .224-32 thread, tap No. V117-----	7
22892	Shoulder Screw, headless, 9/16 inch long, with .218 inch diameter shoulder 9/32 inch long, .182-40 thread, tap No. V109 -----	9
22892 A	Shoulder Screw, headless, 17/32 inch long, with .250 inch diameter shoulder, 11/32 inch long, .182-40 thread, tap No. V109 -----	9
22892 B	Shoulder Screw, headless, 17/32 inch long, with .312 inch diameter shoulder 1/4 inch long, .182-40 thread, tap No. V109 -----	9
22892 C	Shoulder Screw, headless, 25/64 inch long, with .218 inch diameter shoulder 9/32 inch long, .182-40 thread, tap No. V109-----	9
22894	Spot Screw, headless, socket type, cone point, 5/16 inch long, 1/4-28 thread, tap No. V146-----	7
22894 C	Set Screw, headless, socket type, 13/64 inch long, .214-32 thread, tap No. V113-----	7
22894 D	Spot Screw, headless, socket type, 17/64 inch long, .214-32 thread, tap No. V113-----	7
22894 E	Set Screw, headless, socket type, 1/2 inch long, .214-32 thread, tap No. V113-----	7

NUMERICAL LIST OF PARTS

<u>Part No.</u>	<u>Description</u>	<u>Page No.</u>
22894 F	Set Screw, headless, socket type, 5/16 inch long, .255-40 thread, tap No. V92-----	7
22894 G	Set Screw, headless, socket type, 5/8 inch long, .257-32 thread, tap No. V118-----	7
22894 H	Spot Screw, headless, socket type, cone point, 7/16 inch long, .214-32 thread, tap No. V113-----	7
22894 J	Set Screw, headless, socket type, cup point, 5/16 inch long, .214-32 thread, tap No. V113-----	7
22894 K	Spot Screw, headless, socket type, cone point, 25/64 inch long, .214-32 thread, tap No. V113-----	7
22894 L	Spot Screw, headless, socket type, cone point, 5/16 inch long, .214-32 thread, tap No. V113-----	7
22894 N	Spot Screw, headless, socket type, 9/32 inch long, .255-40 thread, tap No. V92-----	7
22894 P	Set Screw, headless, socket type, 3/16 inch long, .182-40 thread, tap No. V109-----	7
22894 R	Set Screw, headless, socket type, 9/32 inch long, .183-32 thread, tap No. V110-----	7
22894 T	Set Screw, headless, socket type, 9/64 inch long, .214-32 thread, tap No. V113-----	7
22894 U	Spot Screw, headless, socket type, 1/4 inch long, cone point, .182-40 thread, tap No. V109-----	7
22894 V	Set Screw, headless, socket type, 7/16 inch long, .255-40 thread, tap No. V92-----	7
22894 W	Set Screw, headless, socket type, 5/32 inch long, .182-40 thread, tap No. V109-----	7
22894 X	Set Screw, headless, socket type, 3/16 inch long, .255-40 thread, tap No. V92-----	7
22894 Y	Set Screw, headless, socket type, 1/8 inch long, .146-40 thread, tap No. V107-----	7
22894 Z	Set Screw, headless, socket type, 5/16 inch long, .182-40 thread, tap No. V109-----	7
22895	Screw, hexagonal head, 1 1/8 inches long, with .404-16 internal thread, tap No. V122, 5/8-18 external thread, tap No. V192-----	7
22896	Screw, hexagonal head, 3 33/64 inches long, with .308-24 threaded section near center of screw and 1/4-28 thread at end, tap No. V146-----	15
22897	Hinge Screw, headless, 37/64 inch long over-all, 7/32 inch long under flange, .146-40 thread, tap No. V107-----	18
22899	Screw, headless, 7/8 inch long, 7/16-27 thread, tap No. V160-----	7
23437 E	Thumbscrew, 1 47/64 inch long, with .375 inch shoulder 3/4 inch long, .257-32 thread, tap No. V118-----	19
23437 W	Shoulder Screw, knurled head, 1 9/16 inches long, with .375 inch diameter shoulder 1 3/16 inches long, .182-40 thread, tap No. V109-----	19
23451 G	Shoulder Stud, headless, 2 7/16 inches long, with .625 inch diameter shoulder 1 11/16 inches long, .257-32 thread, tap No. V118-----	9
28509	Shoulder Screw, fillister head, 29/32 inch long, with .373 inch diameter shoulder .409 inch long, 5/16-18 thread, tap No. V134-----	17
28509 A	Shoulder Screw, fillister head, 1 1/4 inches long, with .375 inch diameter shoulder 3/8 inch long, 5/16-18 thread, tap No. V134-----	17
28509 B	Nut, hexagonal, 5/16 inch thick, 5/16-18 thread, tap No. V134-----	21
30036	Shoulder Screw, fillister head, 1 29/32 inches long, with .264 inch diameter shoulder 1 19/32 inches long, .257-32 thread, tap No. V118-----	17
30077	Nut, circular, 1/4 inch thick, .368-24 thread, tap No. V119 A-----	21
30078	Nut, hexagonal, 1/4 inch thick, .368-24 thread, tap No. V119 A-----	21
30150	Nut, hexagonal, 13/64 inch thick, .257-32 thread, tap No. V118-----	21
33169 A	Shoulder Screw, headless, 13/16 inch long, with .375 inch diameter shoulder 13/32 inch long, .214-32 thread, tap No. V113-----	9
33174 B	Screw, fillister head, 1/4 inch long, .182-40 thread, tap No. V109-----	11
33196	Screw, headless, 9/32 inch long, with hole through center, .510-24 thread, tap No. V124-----	7
35169 A	Nut, hexagonal, 11/64 inch thick, .219-28 thread, tap No. V116-----	21

NUMERICAL LIST OF PARTS

<u>Part No.</u>	<u>Description</u>	<u>Page No.</u>
35172 C	Screw Pin, headless, 31/32 inch long, with .408 inch diameter shoulder 31/64 inch long, .257-32 thread, tap No. V118 -----	9
35176 A	Shoulder Screw, headless, 3/8 inch long, with .230 inch diameter shoulder 7/32 inch long, .182-40 thread, tap No. V109 -----	9
35178 E	Shoulder Screw, fillister head, 27/32 inch long, with .162 inch diameter shoulder 3/4 inch long, .124-50 thread, tap No. V104 -----	17
35178 G	Nut, circular, 1/8 inch thick, .124-50 thread, tap No. V104 -----	20
35569 J	Nut, hexagonal, 5/32 inch thick, .183-32 thread, tap No. V110 -----	21
35572 B	Feed Block Stud, beveled head, 47/64 inch long, with .319 inch diameter shoulder 13/32 inch long, .257-32 thread, tap No. V118 -----	18
35733 B	Nut, circular knurled, 9/32 inch thick, .257-32 thread, tap No. V118 -----	21
35733 G	Nut, hexagonal, 3/16 inch thick, 5/8-24 thread, tap No. V234 -----	21
35735 B	Shoulder Screw, fillister head, 59/64 inch long, with .250 inch diameter shoulder 7/16 inch long, .214-32 thread, tap No. V113 -----	17
35737 C	Shoulder Screw, fillister head, 29/32 inch long, with .259 inch diameter shoulder 13/32 inch long, .257-32 thread, tap No. V118 -----	10
35737 D	Shoulder Screw, fillister head, 1 3/8 inches long, with .259 inch diameter shoulder 19/64 inch long, also with .199 inch diameter pilot 53/64 inch long, .257-32 thread, tap No. V118 -----	7
35751 D	Shoulder Screw, fillister head, 19/32 inch long, with .250 inch diameter shoulder 1/4 inch long, .214-32 thread, tap No. V113 -----	16
35761 B	Nut, circular, knurled, 1/4 inch thick, .671-36 thread, tap No. V126 -----	21
35766	Shoulder Screw, fillister head, 35/64 inch long, with .250 inch diameter shoulder 1/4 inch long, .214-32 thread, tap No. V113 -----	14
35766 A	Nut, circular, 15/64 inch thick, .214-32 thread, tap No. V113 -----	20
35766 B	Nut, circular, 15/64 inch thick, .214-32 thread, tap No. V113 -----	20
35768 A	Screw Pin, 1/4 inch long under flange, .146-40 thread, tap No. V107 -----	8
35795 C	Nut, hexagonal, 3/8 inch thick, .548-18 thread, tap No. V125 -----	21
35830 F	Nut, circular, knurled, 17/64 inch thick, .110-50 thread, tap No. V102 -----	20
35833 A	Screw, headless, 2 11/32 inches long, .257-32 thread, tap No. V118 -----	6
35833 F	Screw, headless, .180 inch diameter, 3/4 inch long over-all, with .312 inch diameter flange 3/16 inch long; 1/4 inch .182-40 thread, tap No. V109 -----	8
35857 D	Lock Nut, circular, 7/64 inch thick, .368-24 thread, tap No. V119 A -----	21
35883 F	Screw Pin, fillister head, 15/16 inch long under head, with .118 inch diameter pilot 5/8 inch long, .146-40 thread, tap No. V107 -----	9
36236 D	Stud, fillister head, 17/32 inch long, .214-32 thread, tap No. V113 -----	10
36236 G	Stud, fillister head, 31/64 inch long, .214-32 thread, tap No. V113 -----	10
36236 J	Stud, fillister head, 15/32 inch long, with .250 inch diameter shoulder .302 inch long, .214-32 thread, tap No. V113 -----	11
36237 H	Screw Pin, 1/4 inch long over-all, with .187 inch diameter head 9/64 inch long, .088-64 thread, tap No. V100 -----	11
36297 D	Drain Plug Screw, fillister head, 21/32 inch long, 1/4 inch long threaded section, .510-24 thread, tap No. V124 -----	13
38241 U	Nut, circular, 13/32 inch thick, .257-32 thread, tap No. V118 -----	20
38251 H	Nut, circular, knurled, 7/16 inch thick, .510-24 thread, tap No. V124 -----	21
38292 G	Shoulder Screw, headless, 2 inches long, with 1/2 inch diameter shoulder 1 1/4 inches long, 3/8-16 thread, tap No. V132 -----	9
38295	Stud, headless, 3 inches long, with 1/4 inch long hexagonal flange, 5/8 inch diameter shoulder 3/8 inch long, and .375 inch diameter shoulder 1 9/16 inches long, .312-18 thread, tap No. V134. Thread above flange 3/8-16, tap No. V132 -----	8
39141 G	Nut, circular, 17/64 inch thick, with 21/64 inch diameter, shoulder 9/64 inch long, .214-32 thread, tap No. V113 -----	20
39151	Nut, hexagonal, 11/64 inch thick, 36V taper thread -----	21
39153 G	Nut, hexagonal, 5/32 inch thick, .510-24 thread, tap No. V124 -----	21
39157 K	Nut, circular, knurled, 1/8 inch thick, 5/16-32 thread, tap No. V93 -----	21
39250 J	Nut, hexagonal, 3/16 inch thick, .146-40 thread, tap No. V107 -----	21
39294 N	Spot Screw, headless, 11/16 inch long, with 5/16 inch long pilot, cone point, .182-40 thread, tap No. V109 -----	7
39295	Base Plate Stud, 1 1/8 inches long over-all, with 3/8 inch threaded portion under hexagonal flange, 5/16-24 thread, tap No. V185 -----	8

NUMERICAL LIST OF PARTS

<u>Part No.</u>	<u>Description</u>	<u>Page No.</u>
39536 B	Shoulder Screw, fillister head, 3/4 inch long over-all, with .188 inch diameter shoulder 17/32 inch long, .182-40 thread, tap No. V109 -----	18
39536 E	Nut, hexagonal, 3/16 inch thick, .182-40 thread, tap No. V109 -----	21
39536 J	Shoulder Screw, fillister head, 1/2 inch long, with shoulder .188 inch diameter 5/16 inch long, .182-40 thread, tap No. V109-----	18
39536 S	Shoulder Screw, fillister head, 15/16 inch long, with .188 inch diameter shoulder 23/32 inch long, .182-40 thread, tap No. V109 -----	17
39536 Y	Screw, beveled head, 3/32 inch long, .146-40 thread, tap No. V107-----	13
39544 M	Screw, countersunk head, 1/2 inch long, .146-40 thread, tap No. V107-----	13
39557 B	Cap Nut, hexagonal head, 5/16 inch thick, .146-40 thread, tap No. V107----	21
39557 E	Nut, hexagonal, 1/8 inch thick, .146-40 thread, tap No. V107-----	21
39557 F	Nut, hexagonal, 3/32 inch thick, 7/16-27 thread, tap No. V160-----	21
39590 N	Shoulder Stud, headless, 1 1/16 inches long, shoulder 1/4 inch diameter 1/2 inch long, has .125 inch diameter pilot 1/4 inch long, .183-32 thread, tap No. V110-----	7
41058 C	Nut, hexagonal, 11/64 inch thick, .182-40 thread, tap No. V109 -----	21
41071 D	Shoulder Screw, hexagonal head, 13/16 inch long, with .319 inch diameter shoulder .370 inch long, .214-32 thread, tap No. V113 -----	18
41071 G	Nut, hexagonal, 3/32 inch thick, .146-40 thread, tap No. V107-----	21
41074	Screw Pin, 1/4 inch long, .088-64 thread, tap No. V100-----	9
41274	Screw Pin, 15/64 inch long, .088-64 thread, tap No. V100-----	8
41274 A	Nut, circular, 1/8 inch thick, .088-64 thread, tap No. V100-----	21
41355	Nut, circular, 1/4 inch thick, .182-40 thread, tap No. V109-----	21
41358 S	Support Pin, 31/64 inch long over-all, with 5/32 inch long threaded section, .124-50 thread, tap No. V104-----	11
41375 V	Nut, circular, knurled, 15/32 inch thick, .510-24 thread, tap No. V124-----	21
41378 D	Adapter Stud, hexagonal head, 5/16 inch long, with .146-40 thread, in head 13/64 inch deep, tap No. V107, .216-22 external thread tap No. V115-----	7
41476	Adapter Stud, hexagonal head, 7/32 inch long, with .124-50 thread in head 11/16 inch deep, tap No. V104, .214-32 external thread, tap No. V113-----	7
41478	Adapter Stud, hexagonal head, 3/8 inch long, with .216-22 thread in head 1/4 inch deep, tap No. V115, .368-24 external thread, tap No. V119 A-----	7
K42171	Screw, headless, .533 inch long, .257-32 thread, tap No. V118 -----	6
43137	Stitch Regulator Nut, .214-32 thread, tap No. V113 -----	20
43137 D	Nut, stitch regulator, .257-32 thread, tap No. V118-----	20
43139 A	Nut, circular, 11/64 inch thick, with 7/64 inch long shoulder, .182-40 thread, tap No. V109-----	20
43143 E	Adjusting Nut, 1/2 inch long, .214-32 thread, 5/16 inch deep, tap No. V113-----	20
43237	Stitch Regulator Nut, .214-32 thread, tap No. V113 -----	20
43239 G	Nut, circular, 11/64 inch thick, with 7/64 inch long shoulder, .155-40 thread, tap No. V108-----	20
43242 P	Nut, hexagonal, 3/32 inch thick, .217-32 left hand thread, tap No. V114---	21
43266	Nut, hexagonal, 1/4 inch thick, .216-22 thread, tap No. V115-----	21
43442 Q	Nut, hexagonal, 9/32 inch thick, .214-32 thread, tap No. V113 -----	20
43443 Q	Nut, hexagonal, 5/64 inch thick, .124-50 thread, tap No. V104-----	21
51036	Feed Crank Stud, 1 1/8 inches long, .214-32 thread, tap No. V113-----	20
51080 A	Throat Plate Support Pin, 2 13/16 inches long, .257-32 thread, tap No. V118-----	8
51136 D	Feed Crank Stud, 1 3/64 inches long, .217-32 left hand thread, tap No. V114-----	20
51136 E	Feed Crank Stud, 1 1/8 inches long, .217-32 left hand thread, tap No. V114-----	20
51170 C	Adapter Screw, headless, 3/4 inch long, with hole through center, 3/8-16 thread, tap No. V132-----	8
51170 D	Nut, hexagonal, 9/64 inch thick, 3/8-16 thread, tap No. V132-----	21
51192 J	Nut, hexagonal, 3/16 inch thick, .216-22 thread, tap No. V115-----	21
51216 P	Nut, hexagonal, 5/32 inch thick, .217-32 left hand thread, tap No. V114-----	21

NUMERICAL LIST OF PARTS

Part No.	Description	Page No.
51235 P	Thumbscrew, knurled head, 3 3/4 inches long, .257-32 thread, tap No. V118 -----	19
51236 C	Feed Crank Stud, 29/32 inches long, .217-32 left hand thread, tap No. V114 -----	20
51236 G	Feed Crank Stud, 1 inch long, .217-32 left hand thread, tap No. V114 ----	20
51246	Nut, hexagonal, 3/8 inch thick, .257-32 thread, tap No. V118 -----	21
51250 C	Nut, hexagonal, 3/32 inch thick, .110-50 thread, tap No. V102 -----	21
51257 H	Nut, hexagonal, 3/16 inch thick, .597-32 thread, tap No. V96 -----	21
51257 J	Cap Nut, hexagonal, 5/8 inch long, 5/16-24 thread, tap No. V185 -----	20
51280 E	Throat Plate Support Pin, 2 1/2 inches long, with pilot 1 5/8 inches long, .257-32 thread, tap No. V118-----	9
51292 C	Nut, circular, knurled, 9/32 inch thick, .224-32 thread, tap No. V117 ---	21
51294 R	Screw, headless, 15/32 inch long over-all, with 1/4 inch diameter flange .067 inch wide located 15/64 inch from end, slotted end threaded .183-32, tap No. V110, .146-40 thread under flange, tap No. V107 -----	8
51430 F	Nut, hexagonal, 1/8 inch thick, .146-40 thread, tap No. V107 -----	20
51462 A	Shoulder Screw, headless, 1 inch long, with .225 inch diameter shoulder 13/16 inch long, .124-50 thread, tap No. V104 -----	9
51959 D	Nut, circular, knurled, 1/4 inch thick, .146-40 thread, tap No. V107 ----	21
52782 C	Adapter Shoulder Stud, fillister head, 1 1/4 inches long, with .281 inch diameter shoulder 23/32 inch long, head tapped .182-40 thread, 9/32 inch deep, tap No. V109, .183-32 external thread, tap No. V110-----	8
52834 N	Nut, hexagonal, 1/4 inch thick, slotted, .155-40 thread, tap No. V108----	21
52841 H	Nut, hexagonal, 1/4 inch thick, .214-32 thread, tap No. V113 -----	21
52841 J	Nut, socket type, 21/64 inch thick, .214-32 thread, tap No. V113 -----	21
52882 V	Adapter Shoulder Stud, fillister head, 1 1/4 inches long, with .281 inch diameter shoulder 5/16 inch long, head tapped .182-40 thread 9/32 inch deep, tap No. V109, .183-32 external thread, tap No. V110 ---	8
52998 K	Screw, countersunk head, 41/64 inch long, .217-32 left hand thread, tap No. V114 -----	13
K53088	Shoulder Screw, fillister head, 17/64 inch long, with .141 inch diameter shoulder 3/32 inch long, .088-64 thread, tap No. V100-----	16
53130 D	Hinge Pin Stud, 11/16 inch long, with .088-64 internal thread 1/4 inch deep, 5/32 inch long section under .218 inch diameter flange has .124-50 thread, tap No. V104 -----	8
53636 A	Feed Driving Arm Stud, fillister head, 1 1/8 inch long, .257-32 thread, tap No. V118 -----	20
53642 J	Locking Stud, fillister head, 25/64 inch long, with 7/64 inch diameter pilot 15/64 inch long, .146-40 thread, tap No. V107 -----	7
53657 A	Cast-off Plate Stud, 2 inches long, with .146-40 internal thread, 1/2 inch deep, tap No. V107, .257-32 external thread, tap No. V118 ----	7
54135	Nut, rectangular, 1/8 inch thick, .124-50 thread, tap No. V104-----	20
54285 C	Nut, square, 1/8 inch thick, .146-40 thread, tap No. V107-----	20
55235 E	Nut, hexagonal, 7/32 inch thick, .255-40 thread, tap No. V92 -----	21
60038 N	Nut, round, 17/64 inch thick, .214-32 thread, tap No. V113 -----	20
60078 Z	Nut, hexagonal, 1/16 inch thick, .088-64 thread, tap No. V100 -----	21
61245	Thumbscrew, knurled head, 5 inches long, No. 14-20 thread, tap No. V130 -----	19
61292 C	Nut, circular, knurled, 3/16 inch thick, .257-32 thread, tap No. V118----	21
61430 AZ	Nut, hexagonal, 1/8 inch thick, .224-32 thread, tap No. V117 -----	21
62245 A	Thumbscrew, knurled head, 7/8 inch long, cone point, .214-32 thread, tap No. V113 -----	7
62245 B	Screw, fillister head, 5/16 inch long, with 3/32 inch long pilot, .214-32 thread, tap No. V113 -----	7
62253 K	Lock Nut, knurled, 1/8 inch thick, .182-40 thread, tap No. V109 -----	21
K66967	Screw, fillister head, 5/32 inch long, .124-50 thread, tap No. V104-----	10
K67228	Screw, button head, 9/64 inch long, .146-40 thread, tap No. V107 -----	13
K67428	Presser Bar Stud, 47/64 inch long over-all, with hexagonal flange 5/64 inch long, 19/64 inch long under flange, .146-40 thread, tap No. V107 -----	8

NUMERICAL LIST OF PARTS

<u>Part No.</u>	<u>Description</u>	<u>Page No.</u>
K68034	Stud, square head, 1 1/8 inches long, with .250 inch diameter shoulder 53/64 inch long, .214-32 thread, tap No. V113 -----	20
K68035	Stud, square head, 1 1/8 inches long, with .250 inch diameter shoulder 53/64 inch long, .217-32 left hand thread, tap No. V114 -----	20
K68569	Nipper Holding Bushing, fillister head, 3/16 inch long, with .182-40 thread tapped in head, external thread .671-36, tap No. V126---	7
78057	Screw, countersunk head, 11/32 inch long, .214-32 thread, tap No. V113 -	13
79048	Screw, hexagonal head, 9/32 inch long, .155-40 thread, tap No. V108 ----	14
79077	Set Screw, headless, 13/64 inch long, .088-64 thread, tap No. V100 -----	6
80003 A-5	Shoulder Screw, fillister head, 23/32 inch long, with .306 inch diameter shoulder 25/64 inch long, No. 14-20 thread, tap No. V130-----	17
80440	Shoulder Screw, fillister head, 19/32 inch long, with .210 inch diameter shoulder 5/16 inch long, .182-40 thread, tap No. V109-----	20
80537	Shoulder Screw, headless, 2 1/4 inches long, with .218 inch diameter shoulder 1 3/4 inches long, .182-40 thread, tap No. V109-----	9
80566	Stitch Regulating Stud, 1 5/8 inches long, with .250 inch diameter shoulder 21/32 inch long, .214-32 thread, tap No. V113 -----	19
80575	Shoulder Screw, fillister head, 2 1/4 inches long, with .437 inch diameter shoulder 1 1/16 inches long, 3/8-16 thread, tap No. V132 -----	17
80576	Nut, hexagonal, 7/32 inch thick, 3/8-16 thread, tap No. V132 -----	21
80630 C	Nut, hexagonal, 7/32 inch thick, .368-24 left hand thread, tap No. V95 ---	21
80630 D	Nut, hexagonal, 7/32 inch thick, .368-24 thread, tap No. V119 A -----	21
80644	Screw, headless, 1/4 inch long, .869-20 thread, tap No. V97-----	6
80691	Nut, hexagonal, 7/32 inch thick, .257-32 thread, tap No. V118 -----	20
80696	Shoulder Stud, square head, 1 9/32 inches long, with .250 inch diameter shoulder 25/32 inch long, .214-32 thread, tap No. V113-----	20
80696 H	Stud, fillister head, 1 39/64 inches long, with .250 inch diameter shoulder 1 3/32 inch long, .214-32 thread, tap No. V113-----	20
92022	Screw, fillister head, 25/64 inch long, .257-32 thread, tap No. V118-----	11
92121	Shoulder Screw, fillister head, 23/64 inch long, with .232 inch diameter shoulder .146 inch long, .214-32 thread, tap No. V113-----	16
92127	Screw, hexagonal head, 1/4 inch long, .214-32 thread, tap No. V113 -----	14
92128	Screw, headless, 23/64 inch long, with hole through center, .368-24 thread, tap No. V119 A -----	7
92131	Shoulder Screw, fillister head, 1 1/8 inches long, with .140 inch diameter shoulder 1 inch long, .126-40 thread, tap No. V105-----	17
92201	Set Screw, headless, 55/64 inch long, .214-32 thread, tap No. V113 -----	6
99112	Machine Screw, countersunk head, 1 inch long, 1/4-20 thread, tap No. V133 -----	13
99245	Screw, hexagonal head, 25/32 inch long, .155-40 thread, tap No. V108 ---	14
99246	Adjusting Screw, 57/64 inch long over-all, with 7/16 inch diameter flange 5/64 inch long, threaded section 5/8 inch long, with slot at end, .155-40 thread, tap No. V108 -----	11
99248	Screw, hexagonal head, 21/64 inch long, .182-40 thread, tap No. V109 ---	14
99251	Hinge Screw, headless, 1 17/32 inches long, with .170 inch diameter shoulder 3/32 inch long, also with .140 inch diameter pilot 1 15/64 inches long, .214-32 thread, tap No. V113-----	9
99256	Screw, fillister head, 27/32 inch long, .404-16 thread, tap No. V122-----	12

CLASSIFIED LIST OF PARTS

<u>Part No.</u>	<u>Description</u>	<u>Page No.</u>
	<u>No. 0-80 Thread</u>	
	<u>.060 inch diameter, 80 threads per inch; tap No. V239, tap drill 3/64 inch (.0469 inch diameter)</u>	
22655 B-7	Screw, fillister head, 7/64 inch long -----	10
	<u>.073-72 Thread</u>	
	<u>.073 inch diameter, 72 threads per inch; tap No. V151, tap drill No. 53 (.0595 inch diameter)</u>	
22565 J	Screw, headless, 3/32 inch long -----	6
22564 E	Screw, fillister head, 3/64 inch long -----	10
22564 F	Screw, fillister head, 5/64 inch long -----	10
22716 F	Screw, countersunk head, 1/16 inch long-----	13
	<u>.088-64 Thread</u>	
	<u>.088 inch diameter, 64 threads per inch; tap No. V100, tap drill No. 49 (.073 inch diameter)</u>	
1059	Screw, headless, 5/64 inch long -----	6
1096	Set Screw, headless, 3/32 inch long -----	6
1096 B	Set Screw, headless, 9/64 inch long -----	6
79077	Set Screw, headless, 13/64 inch long -----	6
22799 U	Hinge Screw, headless, 15/64 inch long-----	8
22799 F	Hinge Screw, headless, 5/16 inch long-----	8
22799 G	Hinge Screw, headless, 25/64 inch long-----	8
22799 H	Hinge Screw, headless, 29/64 inch long-----	8
22799 P	Hinge Screw, headless, 29/64 inch long-----	8
22799 A	Hinge Screw, headless, 33/64 inch long-----	8
22799 R	Hinge Screw, headless, 33/64 inch long-----	8
22799 B	Hinge Screw, headless, 37/64 inch long-----	8
22799 E	Hinge Screw, headless, 41/64 inch long-----	8
22799 C	Hinge Screw, headless, 49/64 inch long-----	8
22799 N	Screw Pin, headless, 11/64 inch long-----	8
22798	Screw, fillister head, 5/64 inch long -----	10
22738 G	Screw, fillister head, 3/32 inch long -----	10
22738 H	Screw, fillister head, .100 inch long -----	10
22738 F	Screw, fillister head, 7/64 inch long -----	10
73 A	Screw, fillister head, 9/64 inch long -----	10
22738 B	Screw, fillister head, 9/64 inch long -----	10
22798 B	Screw, fillister head, 5/32 inch long -----	10
22738	Screw, fillister head, 3/16 inch long -----	10
22798 A	Screw, fillister head, 3/16 inch long -----	10
22738 C	Screw, fillister head, 17/64 inch long -----	11
22738 A	Screw, fillister head, 11/32 inch long -----	11
22738 D	Screw, fillister head, 13/32 inch long -----	11
22734	Screw, fillister head, 31/64 inch long -----	11
22734 B	Screw, fillister head, 17/32 inch long -----	11
22734 A	Screw, fillister head, 19/32 inch long -----	11
22851	Screw, fillister head, 1 3/32 inches long-----	12
22716 A	Screw, countersunk head, 7/64 inch long-----	13
22716 H	Screw, countersunk head, 7/64 inch long-----	13
22716	Screw, countersunk head, 9/64 inch long-----	13
22716 D	Screw, countersunk head, 9/64 inch long-----	13
22716 G	Screw, countersunk head, 3/16 inch long-----	13
21629	Shoulder Screw, fillister head, 13/64 inch long, with .115 inch diameter shoulder 5/32 inch long -----	16
K53088	Shoulder Screw, fillister head, 17/64 inch long, with .141 inch diameter shoulder 3/32 inch long -----	16

CLASSIFIED LIST OF PARTS

<u>Part No.</u>	<u>Description</u>	<u>Page No.</u>
<u>.088-64 Thread (continued)</u>		
22856	Shoulder Screw, round head, 11/32 inch long, with .124 inch diameter shoulder .273 inch long -----	16
41274	Screw Pin, 15/64 inch long -----	8
41074	Screw Pin, 1/4 inch long -----	9
36237 H	Screw Pin, 1/4 inch long over-all, with .187 inch diameter head 9/64 inch long -----	11
60078 Z	Nut, hexagonal, 1/16 inch thick -----	21
41274 A	Nut, circular, 1/8 inch thick -----	21
<u>.100-100 Thread</u>		
<u>.100 inch diameter, 100 threads per inch; tap No. V150, tap drill (.0906 inch diameter)</u>		
22716 E	Screw, fillister head, 5/64 inch long -----	10
22716 B	Screw, countersunk head, 5/64 inch long-----	13
<u>.102-64 Thread</u>		
<u>.102 inch diameter, 64 threads per inch; tap No. V101, tap drill No. 44 (.086 inch diameter)</u>		
22799 S	Hinge Screw, headless, 19/32 inch long-----	8
22767	Screw, fillister head, 7/16 inch long -----	11
22767 A	Screw, fillister head, 1/2 inch long -----	11
22705	Screw, capstan head, 7/32 inch long-----	7
22786	Shoulder Screw, fillister head, 3/8 inch long, with .116 inch diameter shoulder 9/32 inch long -----	16
22799	Shoulder Screw, fillister head, 37/64 inch long, with .109 inch diameter shoulder 13/32 inch long -----	16
22732	Shoulder Screw, fillister head, 19/32 inch long, with .103 inch diameter shoulder 25/64 inch long -----	16
<u>.110-50 Thread</u>		
<u>.110 inch diameter, 50 threads per inch; tap No. V102, tap drill No. 43 (.089 inch diameter)</u>		
91 A	Screw, fillister head, 3/32 inch long -----	10
22784	Screw, fillister head, 3/32 inch long -----	10
22784 A	Screw, fillister head, 3/32 inch long -----	10
604	Screw, fillister head, 9/64 inch long -----	10
22784 E	Screw, fillister head, 9/64 inch long -----	10
605	Screw, fillister head, 5/32 inch long -----	10
22721	Screw, fillister head, 5/32 inch long -----	11
605 A	Screw, fillister head, 7/32 inch long -----	10
22784 F	Screw, fillister head, 1/4 inch long -----	10
22797	Screw, fillister head, 9/32 inch long -----	11
22864	Screw, hexagonal head, 3/4 inch long-----	14
22736	Screw, capstan head, 5/64 inch long-----	7
22736 B	Screw, capstan head, with slot, 5/64 inch long -----	7
22736 A	Screw, capstan head, 7/64 inch long-----	7
22547 A	Screw, round head, 1/8 inch long -----	13
22547 C	Screw, round head, 5/32 inch long -----	13
226	Shoulder Screw, fillister head, 7/64 inch long, with .137 inch diameter shoulder 1/32 inch long -----	16
22599	Shoulder Screw, fillister head, 5/32 inch long, with .138 inch diameter shoulder 1/32 inch long -----	16
22599 C	Shoulder Screw, fillister head, 27/32 inch long, with .110 inch diameter shoulder 5/8 inch long -----	11
51250 C	Nut, hexagonal, 3/32 inch thick -----	21
35830 F	Nut, circular, knurled, 17/64 inch thick -----	20

CLASSIFIED LIST OF PARTS

<u>Part No.</u>	<u>Description</u>	<u>Page No.</u>
	<u>.124-50 Thread</u>	
	<u>.124 inch diameter, 50 threads per inch; tap No. V104, tap drill No. 37 (.104 inch diameter)</u>	
28 A	Screw, headless, 1/16 inch long-----	6
28 B	Screw, headless, 3/32 inch long -----	6
28 C	Screw, headless, 1/8 inch long-----	6
HA73 B	Set Screw, headless, 5/32 inch long-----	6
22733	Set Screw, headless, 11/64 inch long -----	6
73 C	Set Screw, headless, 15/64 inch long -----	6
22565 A	Set Screw, headless, 19/64 inch long -	9
77 Q	Set Screw, headless, 23/64 inch long -----	6
22801	Hinge Screw, headless, 5/32 inch long-----	8
22799 L	Hinge Screw, headless, 9/16 inch long-----	8
22799 D	Hinge Screw, headless, 49/64 inch long-----	8
22799 Q	Hinge Screw, headless, 7/8 inch long-----	8
22799 J	Hinge Screw, headless, 57/64 inch long-----	8
22799 K	Hinge Screw, headless, 31/32 inch long-----	8
187 B	Screw, fillister head, 5/64 inch long -----	10
407 A	Screw, fillister head, 5/64 inch long -----	10
22561 A	Screw, fillister head, 5/64 inch long -----	10
HT2 C	Screw, fillister head, 3/32 inch long -----	10
150	Screw, fillister head, 3/32 inch long -----	11
T26	Screw, fillister head, 7/64 inch long -----	10
187 A	Screw, fillister head, 7/64 inch long -----	10
1059 A	Screw, fillister head, 7/64 inch long -----	10
22768 A	Screw, fillister head, 7/64 inch long -----	10
25 B	Screw, fillister head, 1/8 inch long -----	10
22819	Screw, fillister head, .132 inch long -----	11
22561	Screw, fillister head, 9/64 inch long -----	10
22737	Screw, fillister head, 9/64 inch long, slotted on both ends -----	10
28	Screw, fillister head, 5/32 inch long -----	10
77 A	Screw, fillister head, 5/32 inch long -----	11
77 P	Screw, fillister head, 5/32 inch long -----	10
22563	Screw, fillister head, 5/32 inch long -----	11
22704	Screw, fillister head, 5/32 inch long -----	10
K66967	Screw, fillister head, 5/32 inch long -----	10
77	Screw, fillister head, 3/16 inch long -----	11
77 N	Screw, fillister head, 3/16 inch long -----	10
87 U	Screw, fillister head, 3/16 inch long -----	10
22 KH	Screw, fillister head, 13/64 inch long -----	10
22768	Screw, fillister head, 7/32 inch long -----	10
22768 B	Screw, fillister head, 1/4 inch long -----	10
J87 J	Screw, fillister head, 9/32 inch long -----	10
22593	Screw, fillister head, 9/32 inch long -----	11
22783	Screw, fillister head, 9/32 inch long over-all, 7/64 inch pilot-----	7
77 B	Screw, fillister head, 21/64 inch long -----	11
22804	Screw, fillister head, 11/32 inch long -----	10
22747	Screw, fillister head, 23/64 inch long -----	11
22747 B	Screw, fillister head, 1/2 inch long -----	11
22747 A	Screw, fillister head, 5/8 inch long -----	11
22794 B	Screw, fillister head, 53/64 inch long -----	11
22781	Screw, hexagonal head, 1/4 inch long-----	14
22588 E	Screw, hexagonal head, 31/64 inch long, with .024 inch slot 7/32 inch long in threaded portion-----	14
77 F	Screw, round head, 1/8 inch long-----	13
22547 B	Screw, round head, 9/32 inch long -----	13
22862	Thumbscrew, knurled head, 11/32 inch long under flange -----	12
22845 B	Shoulder Screw, headless, 7/32 inch long, with .156 inch diameter shoulder 3/32 inch long -----	9

CLASSIFIED LIST OF PARTS

<u>Part No.</u>	<u>Description</u>	<u>Page No.</u>
<u>.124-50 Thread (continued)</u>		
22845 A	Shoulder Screw, headless, .259 inch long, with .156 inch diameter shoulder 1/8 inch long -----	9
22845 E	Shoulder Screw, headless, 23/64 inch long, with .156 inch diameter shoulder 11/64 inch long -----	9
22845	Shoulder Screw, headless, 15/32 inch long over-all, with .156 inch diameter shoulder 9/32 inch long -----	9
51462 A	Shoulder Screw, headless, 1 inch long, with .225 inch diameter shoulder 13/16 inch long -----	9
223 C	Shoulder Screw, fillister head, 5/32 inch long, with .141 inch diameter shoulder .085 inch long -----	16
22726 A	Shoulder Screw, fillister head, 5/32 inch long, with .156 inch diameter shoulder 1/32 inch long -----	16
57 WD	Shoulder Screw, fillister head, 17/64 inch long, with .171 inch diameter shoulder 5/32 inch long -----	16
T22	Shoulder Screw, fillister head, 5/16 inch long, with .173 inch diameter shoulder 9/64 inch long -----	16
T23	Shoulder Screw, fillister head, 5/16 inch long, with .173 inch diameter shoulder 7/32 inch long -----	16
22772	Shoulder Screw, fillister head, 5/16 inch long, with .173 inch diameter shoulder 1/16 inch long -----	16
22809 A	Shoulder Screw, fillister head, 3/8 inch long, with double shoulder .187 inch diameter .106 inch long and .156 inch diameter .148 inch long -----	18
15438 D	Shoulder Screw, fillister head, 29/64 inch long, with .187 inch diameter shoulder 1/4 inch long -----	16
22731	Shoulder Screw, fillister head, 1/2 inch long, with 5/32 inch diameter shoulder 3/8 inch long -----	16
22504	Shoulder Screw, fillister head, 9/16 inch long, with .160 inch diameter shoulder 15/32 inch long -----	16
22794 C	Shoulder Screw, fillister head, 5/8 inch long, with .151 inch diameter shoulder 15/32 inch long -----	16
22793	Shoulder Screw, fillister head, 45/64 inch long, with .145 inch diameter shoulder 17/32 inch long -----	16
22794	Shoulder Screw, fillister head, 51/64 inch long, with .148 inch diameter shoulder 5/8 inch long -----	16
22794 A	Shoulder Screw, fillister head, 27/32 inch long, with .151 inch diameter shoulder 11/16 inch long -----	17
35178 E	Shoulder Screw, fillister head, 27/32 inch long, with .162 inch diameter shoulder 3/4 inch long -----	17
22812	Shoulder Screw, button head, 23/64 inch long, with .174 inch diameter shoulder .147 inch long -----	16
22717	Screw Pin, 3/8 inch long -----	7
41358 S	Support Pin, 31/64 inch long over-all, with 5/32 inch long threaded section -----	11
22863	Adjusting Screw, 7/16 inch long over-all, 1/4 inch under flange -----	8
22834	Adjusting Screw, fillister head, 13/32 inch long under flange -----	8
53130 D	Hinge Pin Stud, 11/16 inch long, with .088-64 internal thread 1/4 inch deep, 5/32 inch long section under .218 inch diameter flange -----	8
43443 Q	Nut, hexagonal, 5/64 inch thick -----	21
16179	Nut, rectangular, 1/8 inch thick -----	20
35178 G	Nut, circular, 1/8 inch thick -----	20
54135	Nut, rectangular, 1/8 inch thick -----	20

.124-50 Left Thread

.124 inch diameter, 50 threads per inch; tap No. V214, tap drill No. 37 (.104 inch diameter)

22768 L	Screw, fillister head, 7/32 inch long -----	10
---------	---	----

CLASSIFIED LIST OF PARTS

<u>Part No.</u>	<u>Description</u>	<u>Page No.</u>
	<u>1/8-27 Pipe Thread</u>	
	<u>1/8 inch standard pipe thread, 27 threads per inch; tap No. V158</u>	
22571 B	Pipe Plug, headless, 3/8 inch long-----	7
22571 E	Magnetic Plug Screw, 11/16 inch long, thread part 3/8 inch long-----	7
	<u>.126-40 Thread</u>	
	<u>.126 inch diameter, 40 threads per inch; tap No. V105, tap drill No. 38 (.1015 inch diameter)</u>	
138	Screw, fillister head, 9/64 inch long-----	10
22845 H	Screw, fillister head, 13/64 inch long, dog point-----	11
98 A	Screw, fillister head, 1/4 inch long-----	10
22573	Screw, fillister head, 1/4 inch long-----	11
22745	Screw, fillister head, 1/4 inch long-----	11
22520	Screw, fillister head, 3/8 inch long-----	10
22726 L	Shoulder Screw, fillister head, 11/32 inch long, with .129 inch diameter shoulder 5/32 inch long-----	16
22726 M	Shoulder Screw, fillister head, 27/64 inch long, with .129 inch diameter shoulder 15/64 inch long-----	16
92131	Shoulder Screw, fillister head, 1 1/8 inches long, with .140 inch diameter shoulder 1 inch long-----	17
	<u>No. 6-40 Thread</u>	
	<u>.138 inch diameter, 40 threads per inch; tap No. V266, tap drill No. 34 (.111 inch diameter)</u>	
22876	Screw, fillister head, 1/2 inch long-----	11
22653 J-4	Cap Screw, fillister head, socket type, 1/4 inch long-----	12
	<u>No. 6-36 Thread</u>	
	<u>.138 inch diameter, 36 threads per inch; tap No. V296, tap drill No. 34 (.111 inch diameter)</u>	
22877	Shoulder Screw, fillister head, 13/64 inch long, with .185 inch diameter shoulder 5/64 inch long-----	16
	<u>No. 6-32 Thread</u>	
	<u>.138 inch diameter, 32 threads per inch, tap No. V128, tap drill No. 36 (.1065 inch diameter)</u>	
22784 K	Shoulder Screw, fillister head, 1/2 inch long, with 1/4 inch pilot-----	7
22635 C-12	Machine Screw, round head, 3/16 inch long-----	13
	<u>.146-40 Thread</u>	
	<u>.146 inch diameter, 40 threads per inch; tap No. V107, tap drill No. 31 (.120 inch diameter)</u>	
22743	Screw, headless, 1/8 inch long-----	6
22565 D	Screw, headless, 3/8 inch long-----	6
22575	Screw, headless, 27/64 inch long-----	7
22840 A	Screw, headless, 7/16 inch long-----	6
51294 R	Screw, headless, 15/32 inch long over-all, with 1/4 inch diameter flange .067 inch wide located 15/64 inch from end, slotted end threaded .183-32, tap No. V110-----	8
22565 E	Screw, headless, 9/16 inch long, round point-----	6
4573	Screw, headless, 39/64 inch long-----	6
HS82	Screw, headless, 27/32 inch long-----	6
22565 C	Set Screw, headless, 3/16 inch long-----	6
12935 A	Set Screw, headless, 9/32 inch long-----	6

CLASSIFIED LIST OF PARTS

<u>Part No.</u>	<u>Description</u>	<u>Page No.</u>
<u>.146-40 Thread (continued)</u>		
22894 Y	Set Screw, headless, socket type, 1/8 inch long-----	7
22840 C	Adjusting Screw, headless, 1 5/16 inches long -----	8
22897	Hinge Screw, headless, 37/64 inch long over-all, 7/32 inch long under flange -----	18
22791 E	Screw Pin, headless, 7/8 inch long, with .118 inch diameter pilot 5/8 inch long -----	9
22791 A	Screw Pin, headless, 1 1/8 inches long over-all, cone point, 5/16 inch length of thread-----	9
22791 B	Screw Pin, headless, 1 9/32 inches long over-all, cone point, 5/16 inch length of thread-----	9
22791 C	Screw Pin, headless, 1 13/32 inches long over-all, cone point, 5/16 inch length of thread-----	9
21657 Q	Stud, headless, 1 23/64 inches long over-all, with 1/4 inch long external thread; 7/16 inch deep .146-40 internal thread -----	9
22796	Screw, fillister head, 1/16 inch long -----	10
407	Screw, fillister head, 5/64 inch long -----	10
22564 G	Screw, fillister head, .109 inch long -----	10
22550	Screw, fillister head, 7/64 inch long -----	10
357	Screw, fillister head, 1/8 inch long -----	10
12986 B	Screw, fillister head, 9/64 inch long -----	10
HS24 C	Screw, fillister head, 5/32 inch long -----	10
22564	Screw, fillister head, 5/32 inch long -----	10
22564 B	Screw, fillister head, 5/32 inch long -----	10
22564 H	Screw, fillister head, 5/32 inch long -----	10
22513	Screw, fillister head, 11/64 inch long -----	10
22513 A	Screw, fillister head, 11/64 inch long -----	10
22748 A	Screw, fillister head, 11/64 inch long under flange -----	12
22564 D	Screw, fillister head, 3/16 inch long -----	10
22585 C	Screw, fillister head, 13/64 inch long -----	10
90	Screw, fillister head, 7/32 inch long -----	10
22513 B	Screw, fillister head, 7/32 inch long -----	10
22542	Screw, fillister head, 7/32 inch long -----	10
22562	Screw, fillister head, 7/32 inch long -----	11
22748	Screw, fillister head, 7/32 inch long under flange -----	12
91	Screw, fillister head, 15/64 inch long -----	11
97 X	Screw, fillister head, 15/64 inch long -----	11
22562 A	Screw, fillister head, 9/32 inch long -----	10
22562 B	Screw, fillister head, 9/32 inch long -----	10
91 D	Screw, fillister head, 19/64 inch long -----	11
22585 A	Screw, fillister head, 5/16 inch long -----	10
97	Screw, fillister head, 11/32 inch long -----	11
22585	Screw, fillister head, 11/32 inch long -----	10
22585 G	Screw, fillister head, 11/32 inch long -----	9
22532	Screw, fillister head, 3/8 inch long under flange -----	12
22585 B	Screw, fillister head, 3/8 inch long -----	10
22795	Screw, fillister head, 25/64 inch long under flange -----	12
22775	Screw, fillister head, 13/32 inch long -----	10
22775 A	Screw, fillister head, 13/32 inch long -----	10
22729	Screw, fillister head, 27/64 inch long -----	11
22729 C	Screw, fillister head, 29/64 inch long -----	11
22585 R	Screw, fillister head, 15/32 inch long -----	10
22833	Screw, fillister head, 15/32 inch long -----	11
22729 D	Screw, fillister head, 33/64 inch long -----	11
22543	Screw, fillister head, 9/16 inch long under flange -----	12
22729 A	Screw, fillister head, 5/8 inch long -----	11
82	Screw, fillister head, 47/64 inch long under flange -----	12
22729 B	Screw, fillister head, 13/16 inch long -----	11
82 A	Screw, fillister head, 15/16 inch long under flange -----	12

CLASSIFIED LIST OF PARTS

<u>Part No.</u>	<u>Description</u>	<u>Page No.</u>
<u>.146-40 Thread (continued)</u>		
22718	Screw, fillister head, 1 5/16 inches long under flange-----	12
22870 A	Screw, fillister head without slot, 1 31/32 inches long -----	12
222 D	Screw, countersunk head, 11/64 inch long -----	13
87 B	Screw, countersunk head, 13/64 inch long -----	13
22766	Screw, countersunk head, 7/32 inch long -----	13
AS22 D	Screw, countersunk head, 1/4 inch long -----	13
87	Screw, countersunk head, 1/4 inch long -----	13
22589	Screw, countersunk head, 1/4 inch long -----	13
87 A	Screw, countersunk head, 19/64 inch long -----	13
22524	Screw, countersunk head, 5/16 inch long -----	13
538	Screw, countersunk head, 21/64 inch long -----	13
39544 M	Screw, countersunk head, 1/2 inch long -----	13
22723	Screw, capstan head, 1/4 inch long -----	7
22722	Screw, capstan head, 5/16 inch long under flange-----	7
22825	Screw, round head, 9/64 inch long -----	13
22849 A	Screw, round head, 1/4 inch long -----	13
22849	Screw, round head, 11/32 inch long -----	13
K67228	Screw, button head, 9/64 inch long-----	13
39536 Y	Screw, beveled head, 3/32 inch long -----	13
22551 B	Thumbscrew, knurled head, 11/64 inch long -----	20
22551	Thumbscrew, knurled head, 15/64 inch long -----	20
15489 B	Thumbscrew, 5/16 inch long under flange-----	20
9678	Thumbscrew, knurled head, 13/32 inch long -----	20
G26	Thumbscrew, knurled head, 15/32 inch long -----	20
G10	Thumbscrew, knurled head, 5/8 inch long -----	20
22729 L	Cap Screw, socket type, 27/64 inch long-----	12
21756 G	Screw Pin, headless, 1/8 inch long, with .192 inch diameter shoulder 3/8 inch long-----	9
HS65 P-4	Hinge Screw, headless, 13/32 inch long, with .147 inch diameter shoulder 1/4 inch long-----	8
22845 J	Shoulder Screw, headless, 27/64 inch long, with .180 inch diameter shoulder .281 inch long -----	9
HS100 D	Shoulder Screw, headless, 45/64 inch long, with .156 inch diameter shoulder 19/32 inch long -----	8
22726 B	Shoulder Screw, fillister head, 5/32 inch long, with 3/16 inch diameter shoulder 3/64 inch long -----	16
22726	Shoulder Screw, fillister head, 13/64 inch long, with .249 inch diameter shoulder 5/64 inch long -----	16
22760 A	Shoulder Screw, fillister head, 13/64 inch long, with 3/16 inch diameter shoulder .086 inch long -----	16
22760	Shoulder Screw, fillister head, 15/64 inch long, with .188 inch diameter shoulder .086 inch long -----	16
22772 A	Shoulder Screw, fillister head, 1/4 inch long, with .187 inch diameter shoulder .126 inch long -----	16
22724	Shoulder Screw, fillister head, 11/32 inch long, with .159 inch diameter shoulder 5/32 inch long -----	16
22760 C	Shoulder Screw, fillister head, 3/8 inch long, with .187 inch diameter shoulder 1/8 inch long -----	18
22760 B	Shoulder Screw, fillister head, 13/32 inch long, with 3/16 inch diameter shoulder 1/16 inch long -----	16
22594	Shoulder Screw, fillister head, 27/64 inch long, with .157 inch diameter shoulder 1/4 inch long -----	16
86 X	Shoulder Screw, fillister head, 7/16 inch long, with .180 inch diameter shoulder 19/64 inch long -----	16
97 A	Shoulder Screw, fillister head, 29/64 inch long, with .156 inch diameter shoulder 7/32 inch long -----	16
22559 D	Shoulder Screw, fillister head, 31/64 inch long, with .155 inch diameter shoulder 19/64 inch long -----	16

CLASSIFIED LIST OF PARTS

<u>Part No.</u>	<u>Description</u>	<u>Page No.</u>
<u>.146-40 Thread (continued)</u>		
22595	Shoulder Screw, fillister head, 31/64 inch long, with .156 inch diameter shoulder 15/64 inch long -----	16
22559 A	Shoulder Screw, fillister head, 35/64 inch long, with .155 inch diameter shoulder 19/64 inch long -----	16
22559	Shoulder Screw, fillister head, 19/32 inch long, with .156 inch diameter shoulder 11/32 inch long -----	16
22585 S	Shoulder Screw, fillister head, 5/8 inch long, .153 inch diameter shoulder 7/64 inch long -----	10
22559 F	Shoulder Screw, fillister head, 21/32 inch long, with .163 inch diameter shoulder .437 inch long -----	16
22559 H	Shoulder Screw, fillister head, 1 5/16 inches long, with .250 inch diameter shoulder 1/2 inch long -----	17
22765	Shoulder Screw, hexagonal head, 23/64 inch long, with .185 inch diameter shoulder .072 inch long -----	14
22515	Shoulder Screw, hexagonal head, 3/8 inch long, with .186 inch diameter shoulder 1/8 inch long -----	18
22515 B	Shoulder Screw, hexagonal head, 21/32 inch long, with .225 inch diameter shoulder 13/64 inch long and .157 inch diameter shoulder 7/32 inch long -----	18
22515 A	Shoulder Screw, hexagonal head, 23/32 inch long, with .225 inch diameter shoulder 13/64 inch long -----	18
22818	Shoulder Screw, button head, 5/16 inch long, with .155 inch diameter shoulder 3/32 inch long -----	13
97 B	Shoulder Screw, beveled head, 29/64 inch long, with .156 inch diameter shoulder 7/32 inch long -----	18
35883 F	Screw Pin, fillister head, 15/16 inch long under head, with .118 inch diameter pilot 5/8 inch long -----	9
35768 A	Screw Pin, 7/16 inch long, 1/4 inch long under flange -----	8
22863 A	Screw Pin, 5/8 inch long under flange -----	8
22863 B	Adjusting Screw, 13/32 inch long under flange -----	8
22873	Adjusting Screw, knurled head, 1/2 inch long under knurled flange -----	19
22873 A	Adjusting Screw, knurled head, 5/8 inch long under flange -----	19
22873 B	Adjusting Screw, knurled head, 27/32 inch long under flange -----	19
53642 J	Locking Stud, fillister head, 25/64 inch long, with 7/64 inch diameter pilot 15/64 inch long -----	7
K67428	Presser Bar Stud, 47/64 inch long over-all, with hexagonal flange 5/64 inch long, 19/64 inch long under flange -----	8
525	Bolt Knob, knurled, 3/4 inch long -----	19
41071 G	Nut, hexagonal, 3/32 inch thick -----	21
39557 E	Nut, hexagonal, 1/8 inch thick -----	21
51430 F	Nut, hexagonal, 1/8 inch thick -----	20
39250 J	Nut, hexagonal, 3/16 inch thick -----	21
51959 D	Nut, circular, knurled, 1/4 inch thick -----	21
21185 B	Nut, rectangular, 9/32 inch thick -----	20
54285 C	Nut, square, 1/8 inch thick -----	20
9950	Stop Nut, square, 3/16 inch thick -----	20
39557 B	Cap Nut, hexagonal head, 5/16 inch thick -----	21
21185	Thumb Nut, knurled, 17/64 inch thick -----	21

.155-40 Thread

.155 inch diameter, 40 threads per inch; tap No. V108, tap drill No. 30 (.1285 inch diameter)

22516 B	Screw, fillister head, 11/32 inch long -----	10
22516	Screw, fillister head, 27/64 inch long -----	11
75 C	Screw, fillister head, 7/16 inch long -----	10
22568	Screw, fillister head, 7/16 inch long under flange -----	12
22516 A	Screw, fillister head, 1/2 inch long -----	11

CLASSIFIED LIST OF PARTS

<u>Part No.</u>	<u>Description</u>	<u>Page No.</u>
<u>.155-40 Thread (continued)</u>		
22586 C	Screw, fillister head, 35/64 inch long -----	10
75	Screw, fillister head, 19/32 inch long -----	11
22708	Screw, fillister head, 1 13/32 inches long -----	11
22588	Screw, hexagonal head, 3/16 inch long -----	14
22588 B	Screw, hexagonal head, 17/64 inch long -----	14
79048	Screw, hexagonal head, 9/32 inch long -----	14
22588 A	Screw, hexagonal head, 11/32 inch long -----	14
906	Screw, hexagonal head, 31/64 inch long -----	14
22519 A	Screw, hexagonal head, 9/16 inch long -----	14
906 A	Screw, hexagonal head, 5/8 inch long -----	14
22519 F	Screw, hexagonal head, 5/8 inch long -----	14
22707 A	Screw, hexagonal head, 11/16 inch long -----	14
99245	Screw, hexagonal head, 25/32 inch long -----	14
22707	Screw, hexagonal head, 57/64 inch long -----	14
22525	Screw, countersunk head, 5/16 inch long -----	13
22525 C	Screw, countersunk head, 25/32 inch long -----	13
22826	Screw, round head, 3/4 inch long -----	13
22703	Thumbscrew, knurled head, 7/16 inch long -----	19
HS105 A	Screw Pin, headless, 1 23/64 inches long, with .199 inch diameter shoulder 1 5/32 inches long -----	8
6948 D	Shoulder Screw, headless, 11/16 inch long, with 1/4 inch diameter shoulder 11/32 inch long -----	9
7489 P	Shoulder Screw, headless, 63/64 inch long, with .156 inch diameter shoulder 45/64 inch long -----	8
22755	Shoulder Screw, fillister head, 9/16 inch long, with .162 inch diameter shoulder 3/8 inch long -----	11
75 A	Shoulder Screw, fillister head, 23/32 inch long, with .162 inch diameter shoulder 11/32 inch long -----	13
713	Shoulder Screw, fillister head, 23/32 inch long, with .161 inch diameter shoulder 15/64 inch long -----	16
22559 C	Shoulder Screw, fillister head, 23/32 inch long, with .162 inch diameter shoulder 3/8 inch long -----	16
22770	Shoulder Screw, fillister head, 3/4 inch long, with .160 inch diameter shoulder 19/32 inch long -----	16
22559 J	Shoulder Screw, fillister head, 49/64 inch long, with .217 inch diameter shoulder .485 inch long -----	16
22559 G	Shoulder Screw, fillister head, 25/32 inch long, with .163 inch diameter shoulder 5/16 inch long -----	17
22559 B	Shoulder Screw, fillister head, 53/64 inch long, with .158 inch diameter shoulder 29/64 inch long -----	17
22582	Shoulder Screw, fillister head, 7/8 inch long, with .162 inch diameter shoulder 19/32 inch long -----	17
22559 E	Shoulder Screw, fillister head, 57/64 inch long, with .162 inch diameter shoulder 33/64 inch long -----	17
22868	Shoulder Screw, hexagonal head, 27/32 inch long, with .157 inch diameter shoulder 9/32 inch long -----	14
22868 A	Shoulder Screw, hexagonal head, 27/32 inch long, with .157 inch diameter shoulder 9/16 inch long -----	18
99246	Adjusting Screw, 57/64 inch long over-all, with 7/16 inch diameter flange 5/64 inch long; threaded section 5/8 inch long with slot at end -----	11
907	Nut, hexagonal, 3/32 inch thick -----	21
714	Nut, hexagonal, 5/32 inch thick, slotted -----	21
52834 N	Nut, hexagonal, 1/4 inch thick, slotted -----	21
43239 G	Nut, circular, 11/64 inch thick, with 7/64 inch long shoulder -----	20
6956 D	Nut, castellated, 5/32 inch thick -----	21

CLASSIFIED LIST OF PARTS

<u>Part No.</u>	<u>Description</u>	<u>Page No.</u>
<u>No. 8-32 Thread</u>		
<u>.164 inch diameter, 32 threads per inch; tap No. V129, tap drill No. 29 (.136 inch diameter)</u>		
22875	Screw, fillister head, 9/32 inch long -----	10
22548 A	Screw, fillister head, 5/16 inch long -----	10
22637 N-32	Machine Screw, countersunk head, 1/2 inch long -----	13
22635 B-20	Machine Screw, round head, 5/16 inch long -----	13
22647 K-24	Thumbscrew, 3/8 inch long -----	20
22652 A-6	Cap Screw, socket type, 3/8 inch long -----	12
4954	Nut, circular, slotted, 7/64 inch thick -----	21
<u>.182-40 Thread</u>		
<u>.182 inch diameter, 40 threads per inch; tap No. V109, tap drill No. 22 (.157 inch diameter)</u>		
22560	Screw, headless, 3/32 inch long -----	6
88	Screw, headless, 5/32 inch long -----	6
22560 B	Screw, headless, 15/64 inch long -----	6
531	Screw, headless, 17/64 inch long -----	6
22503 F	Screw, headless, 13/32 inch long -----	6
230	Screw, headless, 15/32 inch long -----	8
719	Screw, headless, 31/64 inch long -----	6
22503	Screw, headless, 1/2 inch long, with .110 inch diameter pilot -----	7
22503 A	Screw, headless, 1/2 inch long, with .160 inch diameter pilot -----	6
35833 F	Screw, headless, .180 inch diameter, 3/4 inch long over-all, with .312 inch diameter flange 3/16 inch long -----	8
88 B	Set Screw, headless, 9/64 inch long -----	6
78	Set Screw, headless, 5/32 inch long -----	6
89	Set Screw, headless, 3/16 inch long -----	6
22560 A	Set Screw, headless, 11/32 inch long -----	6
22894 W	Set Screw, headless, socket type, 5/32 inch long -----	7
22894 P	Set Screw, headless, socket type, 3/16 inch long -----	7
22894 U	Spot Screw, headless, socket type, 1/4 inch long, cone point -----	7
22894 Z	Set Screw, headless, socket type, 5/16 inch long -----	7
22764	Spot Screw, headless, 7/32 inch long -----	6
22764 A	Spot Screw, headless, 9/32 inch long -----	6
22764 B	Spot Screw, headless, 15/32 inch long -----	6
39294 N	Spot Screw, headless, 11/16 inch long, with pilot 5/16 inch long, cone point -----	7
22799 T	Screw Pin, headless, 1 1/8 inches long -----	8
88 A	Screw, fillister head, 5/32 inch long -----	10
22845 G	Screw, fillister head, 5/32 inch long -----	11
22570	Screw, fillister head, 3/16 inch long -----	10
22570 B	Screw, fillister head, 3/16 inch long -----	10
22584	Screw, fillister head, 3/16 inch long -----	10
22830	Screw, fillister head, 3/16 inch long -----	10
25 CC	Screw, fillister head, 13/64 inch long -----	10
255	Screw, fillister head, 13/64 inch long -----	10
22711	Screw, fillister head, 7/32 inch long -----	10
22596 B	Screw, fillister head, 15/64 inch long -----	10
94	Screw, fillister head, 1/4 inch long -----	10
22829	Screw, fillister head, 1/4 inch long -----	10
33174 B	Screw, fillister head, 1/4 inch long -----	11
93 A	Screw, fillister head, 9/32 inch long -----	10
376	Screw, fillister head, 9/32 inch long -----	10
22576	Screw, fillister head, 9/32 inch long -----	10
22710	Screw, fillister head, 9/32 inch long -----	9
22570 A	Screw, fillister head, 19/64 inch long -----	10
88 D	Screw, fillister head, 5/16 inch long -----	10

CLASSIFIED LIST OF PARTS

<u>Part No.</u>	<u>Description</u>	<u>Page No.</u>
<u>.182-40 Thread (continued)</u>		
376 A	Screw, fillister head, 11/32 inch long -----	10
22528 C	Screw, fillister head, 11/32 inch long, with slot in threaded end -----	11
22528	Screw, fillister head, 23/64 inch long -----	10
22596 D	Screw, fillister head, 3/8 inch long -----	10
22596 E	Screw, fillister head, socket type, 3/8 inch long -----	12
22581	Screw, fillister head, 27/64 inch long -----	10
93	Screw, fillister head, 7/16 inch long -----	10
22757	Screw, fillister head, 1/2 inch long -----	10
22596	Screw, fillister head, 35/64 inch long -----	11
22585 H	Screw, fillister head, 5/8 inch long -----	9
22874 C	Screw, fillister head, 43/64 inch long -----	11
88 F	Screw, fillister head, 23/32 inch long -----	11
22835	Screw, fillister head, 3/4 inch long -----	11
22874	Screw, fillister head, 13/16 inch long -----	11
22874 E	Screw, fillister head, 1 inch long -----	11
22874 F	Screw, fillister head, 1 3/16 inches long -----	11
T40	Screw, fillister head, 1 7/32 inches long -----	11
22596 C	Spot Screw, fillister head, 5/16 inch long -----	11
22880	Spot Screw, fillister head, 5/16 inch long -----	11
22824 A	Screw, hexagonal head, 7/64 inch long -----	14
166	Screw, hexagonal head, 5/32 inch long -----	14
22519 G	Screw, slotted hexagonal head, 3/16 inch long -----	14
22519	Screw, hexagonal head, 1/4 inch long -----	14
99248	Screw, hexagonal head, 21/64 inch long -----	14
22567	Screw, hexagonal head, 3/8 inch long -----	14
303	Screw, hexagonal head, 13/32 inch long -----	14
22567 A	Screw, hexagonal head, 13/32 inch long -----	14
22519 H	Screw, slotted hexagonal head, 7/16 inch long -----	14
22519 C	Screw, hexagonal head, 15/32 inch long -----	14
22519 K	Screw, hexagonal head, slotted, 9/16 inch long -----	14
T38	Screw, hexagonal head, 11/16 inch long -----	14
22519 J	Screw, slotted hexagonal head, 13/16 inch long -----	14
22805	Screw, countersunk head, 1/4 inch long -----	13
22525 A	Screw, countersunk head, 5/16 inch long -----	13
22526	Screw, countersunk head, 5/16 inch long -----	13
22790	Screw, countersunk head, 13/32 inch long, with fluted side -----	13
22769	Screw, countersunk head, 17/32 inch long -----	13
22769 A	Screw, countersunk head, 7/8 inch long -----	13
22848	Screw, round head, 11/32 inch long -----	13
188 D	Thumbscrew, knurled head, 5/16 inch long -----	19
22837	Thumbscrew, knurled head, 11/32 inch long -----	19
22774	Thumbscrew, knurled head, 1/2 inch long -----	20
22841	Thumbscrew, knurled, 41/64 inch long under flange -----	20
22837 A	Thumbscrew, knurled head, 29/32 inch long -----	20
22756	Wing Screw, 13/64 inch long -----	20
22756 A	Wing Screw, 9/32 inch long -----	20
G44	Screw, capstan head, 1/4 inch long -----	7
22713	Screw, capstan head, 7/16 inch long -----	7
35176 A	Shoulder Screw, headless, 3/8 inch long, with .230 inch diameter shoulder 7/32 inch long -----	9
22892 C	Shoulder Screw, headless, 25/64 inch long, with .218 inch diameter shoulder 9/32 inch long -----	9
22892 A	Shoulder Screw, headless, 17/32 inch long, with .250 inch diameter shoulder 11/32 inch long -----	9
22892 B	Shoulder Screw, headless, 17/32 inch long, with .312 inch diameter shoulder 1/4 inch long -----	9
T2	Shoulder Screw, headless, 9/16 inch long, with 1/4 inch diameter shoulder 7/16 inch long -----	9

CLASSIFIED LIST OF PARTS

<u>Part No.</u>	<u>Description</u>	<u>Page No.</u>
<u>.182-40 Thread (continued)</u>		
22892	Shoulder Screw, headless, 9/16 inch long, with .218 inch diameter shoulder 9/32 inch long -----	9
42 A	Shoulder Screw, headless, 11/16 inch long, with .250 inch diameter shoulder 7/16 inch long -----	9
J42 JK	Shoulder Screw, headless, 47/64 inch long, with .210 inch diameter shoulder 19/64 inch long -----	9
1332	Shoulder Screw, headless, 13/16 inch long, with .248 inch diameter shoulder 9/16 inch long -----	9
22799 M	Shoulder Screw, headless, 7/8 inch long, with .217 inch diameter shoulder 19/32 inch long -----	8
80537	Shoulder Screw, headless, 2 1/4 inches long, with .218 inch diameter shoulder 1 3/4 inches long -----	9
134	Shoulder Screw, fillister head, 5/32 inch long, with .219 inch diameter shoulder, .065 inch long -----	16
22504 B	Shoulder Screw, fillister head, 5/32 inch long, with .216 inch diameter shoulder 1/16 inch long, with hole drilled and tapped in head; internal thread .146-40, tap No. V107-----	7
22758	Shoulder Screw, fillister head, 15/64 inch long, with .219 inch diameter shoulder 7/64 inch long -----	16
22758 C	Shoulder Screw, fillister head, 15/64 inch long, with .217 inch diameter shoulder .070 inch long -----	16
22735	Shoulder Screw, fillister head, 17/64 inch long, with .257 inch diameter shoulder 5/32 inch long -----	16
22746	Shoulder Screw, fillister head, 17/64 inch long, with 15/64 inch diameter shoulder 9/64 inch long -----	16
86	Shoulder Screw, fillister head, 19/64 inch long, with .219 inch diameter shoulder 9/64 inch long -----	16
HA65 L	Shoulder Screw, fillister head, 5/16 inch long, with .199 inch diameter shoulder 7/32 inch long -----	16
240	Shoulder Screw, fillister head, 5/16 inch long, with .219 inch diameter shoulder 9/64 inch long -----	16
22758 E	Shoulder Screw, fillister head, 5/16 inch long, with .250 inch diameter shoulder 1/8 inch long -----	16
22758 B	Shoulder Screw, fillister head, 21/64 inch long, with .217 inch diameter shoulder 5/64 inch long -----	16
15872 D	Shoulder Screw, fillister head, 11/32 inch long, with .227 inch diameter shoulder 13/64 inch long -----	16
22787 B	Shoulder Screw, fillister head, 11/32 inch long, with .240 inch diameter shoulder 7/32 inch long -----	16
T18	Shoulder Screw, fillister head, 3/8 inch long, with .242 inch diameter shoulder 19/64 inch long -----	16
22762	Shoulder Screw, fillister head, 3/8 inch long, with .222 inch diameter shoulder 7/32 inch long -----	18
HS65 O	Shoulder Screw, fillister head, 13/32 inch long, with .197 inch diameter shoulder 7/32 inch long -----	16
402	Shoulder Screw, headless, 13/32 inch long, with 1/4 inch diameter shoulder 1/4 inch long -----	9
22504 C	Shoulder Screw, fillister head, 13/32 inch long, with .256 inch diameter shoulder 5/32 inch long -----	11
22504 D	Shoulder Screw, fillister head, 13/32 inch long, .319 inch diameter shoulder .159 inch long -----	16
22735 A	Shoulder Screw, fillister head, 13/32 inch long, with .257 inch diameter shoulder .158 inch long -----	16
22757 B	Shoulder Screw, fillister head, 13/32 inch long, with .222 inch diameter shoulder 5/16 inch long -----	16
22758 F	Shoulder Screw, fillister head, 13/32 inch long, with .250 inch diameter shoulder .159 inch long -----	16

CLASSIFIED LIST OF PARTS

<u>Part No.</u>	<u>Description</u>	<u>Page No.</u>
<u>.182-40 Thread (continued)</u>		
22787	Shoulder Screw, fillister head, 13/32 inch long, with .220 inch diameter shoulder 7/32 inch long -----	16
14076	Shoulder Screw, fillister head, 27/64 inch long, with .219 inch diameter shoulder 9/64 inch long -----	16
22742	Shoulder Screw, fillister head, 27/64 inch long, with .273 inch diameter shoulder 5/64 inch long -----	16
22787 D	Shoulder Screw, fillister head, 27/64 inch long, with .328 inch diameter shoulder .229 inch long -----	16
16382	Shoulder Screw, fillister head, 7/16 inch long, with .315 inch diameter shoulder 7/32 inch long -----	16
HA65 E	Shoulder Screw, fillister head, 29/64 inch long, with .199 inch diameter shoulder 19/64 inch long -----	16
22778	Shoulder Screw, fillister head, 29/64 inch long, with .220 inch diameter shoulder .223 inch long -----	16
22504 A	Shoulder Screw, fillister head, 15/32 inch long, with .256 inch diameter shoulder 5/32 inch long -----	16
12997 A	Shoulder Screw, fillister head, 1/2 inch long, with .227 inch diameter shoulder 7/32 inch long -----	16
22758 H	Shoulder Screw, fillister head, 1/2 inch long, with .188 inch diameter shoulder 7/32 inch long -----	10
22773	Shoulder Screw, fillister head, 1/2 inch long, with 7/32 inch diameter shoulder 1/4 inch long -----	16
22776	Shoulder Screw, fillister head, 1/2 inch long, with .220 inch diameter flattened shoulder 3/8 inch long -----	18
39536 J	Shoulder Screw, fillister head, 1/2 inch long, with .188 inch diameter shoulder 5/16 inch long -----	18
3341	Shoulder Screw, fillister head, 33/64 inch long, with .226 inch diameter shoulder 1/4 inch long -----	16
C41	Shoulder Screw, fillister head, 35/64 inch long, with .219 inch diameter shoulder 13/32 inch long -----	16
22773 A	Shoulder Screw, fillister head, 19/32 inch long, with .184 inch diameter shoulder 1/4 inch long -----	16
22867	Shoulder Screw, fillister head, 19/32 inch long, with .187 inch diameter shoulder 9/32 inch long -----	17
80440	Shoulder Screw, fillister head, 19/32 inch long, with .210 inch diameter shoulder 5/16 inch long -----	20
22598 E	Shoulder Screw, fillister head, 11/16 inch long, with .250 inch diameter shoulder 7/16 inch long -----	17
22587 H	Shoulder Screw, fillister head, 23/32 inch long, with .188 inch diameter shoulder 3/8 inch long -----	16
22598	Shoulder Screw, fillister head, 23/32 inch long, with .249 inch diameter shoulder 27/64 inch long -----	16
22874 D	Shoulder Screw, fillister head, 23/32 inch long under flange, with 1/4 inch diameter shoulder flattened to .195 inch across flats 7/64 inch long -----	17
469	Shoulder Screw, fillister head, 47/64 inch long, with .199 inch diameter shoulder 19/32 inch long -----	17
22598 A	Shoulder Screw, fillister head, 3/4 inch long, with 1/4 inch diameter shoulder 1/2 inch long -----	17
39536 B	Shoulder Screw, fillister head, 3/4 inch long over-all, with .188 inch diameter shoulder 17/32 inch long -----	18
11947	Shoulder Screw, fillister head, 51/64 inch long, with .200 inch diameter shoulder 19/32 inch long -----	17
22598 D	Shoulder Screw, fillister head, 13/16 inch long, with 1/4 inch diameter shoulder 1/2 inch long -----	17
9846 A	Shoulder Screw, fillister head, 53/64 inch long, with .228 inch diameter shoulder 39/64 inch long -----	17

CLASSIFIED LIST OF PARTS

<u>Part No.</u>	<u>Description</u>	<u>Page No.</u>
<u>.182-40 Thread (continued)</u>		
39536 S	Shoulder Screw, fillister head, 15/16 inch long, with .188 inch diameter shoulder 23/32 inch long -----	17
9846	Shoulder Screw, fillister head, 63/64 inch long, with .227 inch diameter shoulder 39/64 inch long -----	17
22773 B	Shoulder Screw, fillister head, 1 5/32 inches long, with .184 inch diameter shoulder 7/8 inch long -----	11
22828	Shoulder Screw, hexagonal head, 9/32 inch long, with 5/16 inch diameter shoulder 1/32 inch long -----	18
22739	Shoulder Screw, hexagonal head, 3/8 inch long, with .200 inch diameter shoulder 11/64 inch long -----	18
22519 E	Shoulder Screw, hexagonal head, 1/2 inch long, with 1/4 inch diameter shoulder 3/32 inch long -----	18
22832	Shoulder Screw, hexagonal head, 9/16 inch long, with .190 inch diameter shoulder 1/8 inch long -----	18
22853 A	Shoulder Screw, hexagonal head, 9/16 inch long, with .248 inch diameter shoulder 5/64 inch long -----	18
T12	Shoulder Screw, hexagonal head, 45/64 inch long, with .250 inch diameter shoulder 3/8 inch long -----	18
12934 B	Shoulder Screw, hexagonal head, 47/64 inch long, with .319 inch diameter shoulder 33/64 inch long -----	18
22853	Shoulder Screw, hexagonal head, 47/64 inch long, with .248 inch diameter shoulder 9/32 inch long -----	18
16190	Shoulder Screw, hexagonal head, 27/32 inch long, with 1/4 inch diameter shoulder 37/64 inch long -----	18
16257 J	Shoulder Screw, hexagonal head, 1 5/64 inches long, with .200 inch diameter shoulder 29/32 inch long -----	18
23437 W	Shoulder Screw, knurled head, 1 9/16 inch long, with .375 inch diameter shoulder, 1 3/16 inch long -----	19
22728 A	Adjusting Screw, knurled head, 11/16 inch long, with 1/4 inch diameter shoulder 7/16 inch long -----	18
22837 C	Thumbscrew, knurled head, 29/32 inch long, with 5/16 inch diameter shoulder 11/32 inch long -----	18
15447 A	Screw Pin, flanged, 1 3/32 inches long over-all, threaded portion 7/16 inch long -----	8
22841 A	Screw Post, hexagonal, 1 1/4 inches long, internal thread .182-40 11/16 inch deep, tap No. V109 -----	8
15037 D	Locking Screw, with handle extension, 41/64 inch long under flange ---	19
14077	Nut, hexagonal, 5/64 inch thick -----	21
12934 A	Nut, hexagonal, 3/32 inch thick -----	21
9937	Nut, hexagonal, 1/8 inch thick -----	21
41058 C	Nut, hexagonal, 11/64 inch thick -----	21
39536 E	Nut, hexagonal, 3/16 inch thick -----	21
5144	Nut, hexagonal, slotted, 9/32 inch thick -----	21
T14	Cap Nut, hexagonal head, 27/64 inch thick -----	20
377	Nut, circular, slotted, 3/32 inch thick -----	21
479	Nut, circular, 5/32 inch thick -----	21
21390 L	Nut, circular, 11/64 inch thick -----	20
43139 A	Nut, circular, 11/64 inch thick with 7/64 inch long shoulder - -----	20
41355	Nut, circular, 1/4 inch thick -----	21
T29	Nut, circular, knurled, 29/64 inch thick -----	21
21198 J	Nut, rectangular, 1/8 inch thick -----	20
62253 K	Lock Nut, knurled, 1/8 inch thick -----	21
T6	Nut, .415 inch diameter, fluted with 10 slots, 3/16 inch thick -----	21

.183-32 Thread

.183 inch diameter, 32 threads per inch; tap No. V110, tap drill No. 24 (.152 inch diameter)

22565	Set Screw, headless, 11/64 inch long -----	6
-------	--	---

CLASSIFIED LIST OF PARTS

<u>Part No.</u>	<u>Description</u>	<u>Page No.</u>
<u>.183-32 Thread (continued)</u>		
22894 R	Set Screw, headless, socket type, 9/32 inch long -----	7
22565 B	Set Screw, headless, cup point, 3/8 inch long -----	6
22565 F	Spot Screw, headless, 1/2 inch long -----	6
22565 H	Spot Screw, headless, 1/2 inch long -----	6
73 XA	Screw, fillister head, cup point, 5/32 inch long -----	11
73	Screw, fillister head, 3/16 inch long -----	11
22569 A	Screw, fillister head, cup point, 3/16 inch long -----	11
72	Screw, fillister head, 15/64 inch long -----	11
22569 H	Screw, fillister head, cup point, 15/64 inch long with "Nylok" insert --	10
22569 D	Screw, fillister head, 1/4 inch long -----	10
22569 F	Screw, fillister head, 9/32 inch long -----	10
79	Screw, fillister head, 11/32 inch long -----	11
22569 C	Screw, fillister head, 11/32 inch long -----	10
22569 G	Screw, fillister head, 11/32 inch long -----	10
J79 J	Screw, fillister head, 27/64 inch long -----	11
22569 B	Screw, fillister head, 7/16 inch long -----	10
22572	Screw, fillister head, 7/16 inch long -----	11
22572 B	Screw, fillister head, socket type, 7/16 inch long -----	12
22541 B	Screw, fillister head, 15/32 inch long -----	10
22569	Screw, fillister head, 33/64 inch long -----	11
22572 A	Screw, fillister head, 35/64 inch long -----	11
22541	Screw, fillister head, 21/32 inch long -----	11
294	Screw, fillister head, 15/16 inch long -----	11
22592	Screw, fillister head, 1 11/64 inch long -----	11
73 X	Set Screw, fillister head, 3/16 inch long -----	10
22824	Screw, hexagonal head, 3/16 inch long -----	14
22757 E	Screw, countersunk head, 21/64 inch long including .140 inch diameter pilot 3/64 inch long -----	10
21745 D	Thumbscrew, 11/16 inch long -----	20
21745 C	Thumbscrew, 1 inch long -----	20
14	Hinge Screw, headless, 1 13/16 inches long, with .192 inch diameter shoulder 1 1/2 inches long -----	8
39590 N	Shoulder Stud, headless, 1 1/16 inches long, shoulder 1/4 inch diameter 1/2 inch long, has .125 inch diameter pilot 1/4 inch long ---	7
22587 D	Shoulder Screw, fillister head, 13/32 inch long, with .186 inch diameter shoulder 13/64 inch long -----	17
22587 B	Shoulder Screw, fillister head, 31/64 inch long, with .187 inch diameter shoulder 15/64 inch long -----	17
22587 J	Shoulder Screw, fillister head, 37/64 inch long, with .187 inch diameter shoulder 15/64 inch long -----	17
22587 E	Shoulder Screw, fillister head, 19/32 inch long, with .186 inch diameter shoulder 11/32 inch long -----	17
52882 V	Adapter Shoulder Stud, fillister head, 1 1/4 inches long, with .281 inch diameter shoulder 5/16 inch long, head tapped .182-40 thread 9/32 inch deep, tap No. V109 -----	8
52782 C	Adapter Shoulder Stud, fillister head, 1 1/4 inches long, with .281 inch diameter shoulder 23/32 inch long, head tapped .182-40 thread 9/32 inch deep, tap No. V109 -----	8
22792 A	Shoulder Screw, hexagonal head, 25/64 inch long, with 1/4 inch diameter shoulder 1/64 inch long -----	18
22792	Shoulder Screw, hexagonal head, 1/2 inch long, with .250 inch diameter shoulder 5/32 inch long -----	18
7947	Nut, hexagonal, 5/64 inch thick -----	21
37 R	Nut, hexagonal, 1/8 inch thick -----	21
35569 J	Nut, hexagonal, 5/32 inch thick -----	21
42 H	Nut, circular, 1/8 inch thick -----	7
21745 B	Wing Nut -----	21

CLASSIFIED LIST OF PARTS

<u>Part No.</u>	<u>Description</u>	<u>Page No.</u>
	<u>.183-32 Left Thread</u>	
	<u>.183 inch diameter, 32 threads per inch; tap No. V111, tap drill No. 24 (.152 inch diameter)</u>	
22757 F	Screw, fillister head, 3/16 inch long -----	10
22757 A	Screw, countersunk head, 13/32 inch long -----	10
22757 C	Screw, countersunk head, 13/32 inch long -----	13
22757 D	Screw, countersunk head, 13/32 inch long -----	13
22758 A	Shoulder Screw, fillister head, 33/64 inch long, with .226 inch diameter shoulder 1/4 inch long -----	16
22758 G	Shoulder Screw, fillister head, 17/32 inch long, with .312 inch diameter shoulder .287 inch long -----	16
7948	Nut, hexagonal, 5/64 inch thick-----	21
37 L	Nut, hexagonal, 1/8 inch thick-----	21
	<u>3/16-32 Thread</u>	
	<u>.187 inch diameter, 32 threads per inch, tap No. V311, tap drill No. 22 (.157 inch diameter)</u>	
22878	Set Screw, headless, 3/16 inch long-----	6
	<u>.191-28 Thread</u>	
	<u>.191 inch diameter, 28 threads per inch; tap No. V112, tap drill No. 22 (.157 inch diameter)</u>	
248	Screw Pin, headless, 1 1/2 inches long, with .139 inch diameter pilot 1 1/8 inches long -----	9
22791 F	Screw Pin, headless, 1 11/16 inches long, with .139 inch diameter pilot 1 inch long -----	9
22518	Screw, fillister head, 37/64 inch long -----	11
85	Screw, fillister head, 29/32 inch long -----	11
22522	Screw, fillister head, 1 1/32 inches long -----	11
250 A	Screw, fillister head, 1 9/16 inches long -----	11
250	Screw, fillister head, 1 19/32 inches long -----	17
15839 A	Shoulder Screw, headless, 19/32 inch long, with .265 inch diameter shoulder 5/16 inch long -----	9
4937	Shoulder Screw, fillister head, 9/16 inch long, with .257 inch diameter shoulder 5/16 inch long -----	16
22744	Shoulder Screw, fillister head, 27/32 inch long, with .257 inch diameter shoulder 19/64 inch long -----	17
22577	Screw Pin, 1 inch long-----	9
22791	Screw Pin, 1 7/32 inches long -----	9
249	Nut, hexagonal, 9/64 inch thick-----	21
	<u>No. 10-32 Thread</u>	
	<u>.190 inch diameter, 32 threads per inch; tap No. V209, tap drill No. 21 (.159 inch diameter)</u>	
22651 CB-4	Set Screw, headless, socket type, cup point, 1/4 inch long -----	7
22653 B-8	Cap Screw, fillister head, socket type, 1/2 inch long -----	12
22653 B-12	Cap Screw, fillister head, socket type, 3/4 inch long -----	12
22653 B-16	Cap Screw, fillister head, socket type, 1 inch long -----	12
22881 A	Screw, hexagonal head, 7/16 inch long -----	14
22649 F-16	Machine Screw, round head, 1/4 inch long -----	13
	<u>No. 10-24 Thread</u>	
	<u>.190 inch diameter, 24 threads per inch; tap No. V208, tap drill No. 25 (.1495 inch diameter)</u>	
22650 CB-3	Set Screw, headless, socket type, cup point, 3/16 inch long -----	7

CLASSIFIED LIST OF PARTS

<u>Part No.</u>	<u>Description</u>	<u>Page No.</u>
<u>No. 10-24 Thread (continued)</u>		
22650 CB-4	Set Screw, headless, socket type, cup point, 1/4 inch long -----	7
22813	Set Screw, headless, 1/4 inch long-----	6
22652 B-8	Cap Screw, fillister head, socket type, 1/2 inch long -----	12
22652 B-10	Cap Screw, fillister head, socket type, 5/8 inch long -----	12
22635 F-32	Machine Screw, round head, 1/2 inch long -----	13
22632 F-24	Set Screw, square head, cup point, 3/8 inch long -----	15
<u>.214-32 Thread</u>		
.214 inch diameter, 32 threads per inch; tap No. V113, tap drill No. 14 (.182 inch diameter)		
22580 D	Set Screw, headless, 1/8 inch long-----	6
22580	Set Screw, headless, 9/64 inch long-----	6
22894 T	Set Screw, headless, socket type, 9/64 inch long -----	7
98	Set Screw, headless, 13/64 inch long-----	6
22894 C	Set Screw, headless, socket type, 13/64 inch long -----	7
95	Set Screw, headless, 15/64 inch long-----	6
22752	Set Screw, headless, 15/64 inch long, with .100 inch diameter pilot 7/64 inch long -----	7
22752 A	Set Screw, headless, 15/64 inch long, with .070 inch diameter pilot 7/64 inch long -----	7
22580 A	Set Screw, headless, 9/32 inch long-----	6
22894 J	Set Screw, headless, socket type, cup point, 5/16 inch long -----	7
22752 C	Set Screw, headless, 11/32 inch long, with .100 inch diameter pilot 5/64 inch long -----	7
22597 A	Set Screw, headless, 13/32 inch long-----	6
22894 E	Set Screw, headless, socket type, 1/2 inch long-----	7
22597 E	Set Screw, headless, 5/8 inch long-----	6
92201	Set Screw, headless, 55/64 inch long-----	6
22560 G	Spot Screw, headless, 3/16 inch long-----	7
96	Spot Screw, headless, 17/64 inch long-----	6
22894 D	Spot Screw, headless, socket type, 17/64 inch long-----	7
96 A	Spot Screw, headless, 5/16 inch long-----	6
22894 L	Spot Screw, headless, socket type, cone point, 5/16 inch long -----	7
81	Spot Screw, headless, 25/64 inch long-----	6
22894 K	Spot Screw, headless, socket type, cone point, 25/64 inch long -----	7
22894 H	Spot Screw, headless, socket type, cone point, 7/16 inch long -----	7
22597	Spot Screw, headless, 1/2 inch long-----	6
22597 B	Spot Screw, headless, 1/2 inch long-----	6
22702	Screw Bushing, headless, 3/32 inch long -----	7
12035	Screw Bushing, headless, 11/64 inch long -----	7
22791 G	Screw Pin, headless, 1 1/8 inches long, with .156 inch diameter pilot, 7/16 inch long -----	9
22791 D	Screw Pin, headless, 1 1/2 inches long, with .156 inch diameter pilot 3/4 inch long -----	9
22530	Screw, fillister head, 7/64 inch long -----	10
92 A	Screw, fillister head, 9/64 inch long -----	10
22730	Screw, fillister head, 13/64 inch long -----	10
22839 B	Screw, fillister head, 7/32 inch long -----	10
22836	Screw, fillister head, 1/4 inch long -----	10
25 S	Screw, fillister head, 9/32 inch long -----	10
92	Screw, fillister head, 9/32 inch long -----	7
22839 A	Screw, fillister head, 9/32 inch long -----	10
HA61 D	Screw, fillister head, 5/16 inch long -----	11
22517 C	Screw, fillister head, 5/16 inch long, with .124-50 internal thread, tap No. V104-----	7
22517 F	Screw, fillister head, 5/16 inch long, with .110-50 internal thread, tap No. V102-----	7

CLASSIFIED LIST OF PARTS

<u>Part No.</u>	<u>Description</u>	<u>Page No.</u>
<u>. 214-32 Thread (continued)</u>		
22839 C	Screw, fillister head, 5/16 inch long -----	10
62245 B	Screw, fillister head, 5/16 inch long, with 3/32 inch long pilot-----	7
22578	Screw, fillister head, 11/32 inch long -----	16
22517 B	Screw, fillister head, 3/8 inch long -----	10
22839	Screw, fillister head, 13/32 inch long -----	10
22839 D	Screw, fillister head, 13/32 inch long -----	10
22517	Screw, fillister head, 7/16 inch long -----	11
22548	Screw, fillister head, 7/16 inch long -----	10
141	Screw, fillister head, 17/32 inch long -----	10
22861 B	Screw, fillister head, 19/32 inch long -----	11
136	Screw, fillister head, 21/32 inch long -----	11
816	Screw, fillister head, 11/16 inch long -----	10
897 D	Screw, fillister head, 11/16 inch long -----	10
22839 E	Screw, fillister head, 23/32 inch long -----	11
22861 A	Screw, fillister head, 23/32 inch long -----	11
74	Screw, fillister head, 25/32 inch long -----	11
22719	Screw, fillister head, with sides of head flat, 13/16 inch long-----	20
22839 F	Screw, fillister head, 7/8 inch long -----	11
22842	Screw, fillister head, 7/8 inch long -----	10
15773	Screw, fillister head, 1 inch long under flange -----	12
22861	Screw, fillister head, 1 1/16 inches long -----	10
22517 A	Screw, fillister head, 1 9/64 inches long -----	11
22517 D	Screw, fillister head, 1 9/64 inches long -----	12
22780	Screw, fillister head, 1 5/8 inches long under flange-----	12
36236 G	Stud, fillister head, 31/64 inch long-----	10
36236 D	Stud, fillister head, 17/32 inch long-----	10
92127	Screw, hexagonal head, 1/4 inch long -----	14
22882	Screw, hexagonal head, 3/8 inch long -----	14
22852	Screw, hexagonal head, 1/2 inch long -----	14
627	Screw, hexagonal head, 19/32 inch long -----	14
22852 A	Screw, slotted, hexagonal head, 19/32 inch long, special steel -----	14
627 A	Screw, hexagonal head, 13/16 inch long -----	14
22882 A	Screw, hexagonal head, 13/16 inch long -----	14
22881	Screw, hexagonal head, 15/16 inch long -----	14
41476	Adapter Stud, hexagonal head, 7/32 inch long, with . 124-50 thread in head 11/16 inch deep, tap No. V104 -----	7
22841 H	Adjusting Screw, 1 1/16 inches long over-all, 3/8 inch hexagonal head, 1/2 inch long, with . 217-32 left hand internal thread, tap No. V114 -----	8
76	Screw, countersunk head, 1/4 inch long -----	13
22807	Screw, countersunk head, 5/16 inch long -----	13
78057	Screw, countersunk head, 11/32 inch long -----	13
80	Screw, countersunk head, 33/64 inch long -----	13
22574	Screw, countersunk head, 21/32 inch long -----	13
22574 C	Screw, countersunk head, 3/4 inch long -----	13
22888	Screw, countersunk head, 59/64 inch long -----	13
22574 A	Screw, countersunk head, 1 1/32 inches long-----	13
22535	Screw, countersunk head, 1 3/64 inches long-----	13
25 T	Thumbscrew, knurled head, 11/64 inch long -----	20
C24	Thumbscrew, knurled head, 1/4 inch long -----	20
25 TB	Thumbscrew, knurled head, 13/32 inch long -----	20
9450	Thumbscrew, knurled head, 5/8 inch long -----	19
14087	Thumbscrew, knurled head, 27/32 inch long -----	(-)
62245 A	Thumbscrew, knurled head, 7/8 inch long, cone point-----	7
12981	Bolt, square head, 1 3/16 inches long-----	20
15481	Bolt, square head, 1 /316 inches long - -----	15

NOTE: A Dash (-) in the "Page No." column denotes the absence of an illustration.

CLASSIFIED LIST OF PARTS

<u>Part No.</u>	<u>Description</u>	<u>Page No.</u>
<u>.214-32 Thread (continued)</u>		
21227 J	Hand Screw, 7/8 inch long -----	19
11341	Feed Crank Stud, 47/64 inch long, 9/32 inch of thread -----	20
17	Feed Crank Stud, 7/8 inch long -----	20
17 A	Feed Crank Stud, 7/8 inch long -----	20
17 B	Feed Crank Stud, 7/8 inch long -----	20
17 X	Feed Crank Stud, 7/8 inch long -----	20
51036	Feed Crank Stud, 1 1/8 inches long -----	20
22802 A	Shoulder Screw, headless, 1/2 inch long, with .436 inch diameter shoulder 11/32 inch long-----	9
22845 C	Shoulder Screw, headless, 1/2 inch long, with .257 inch diameter shoulder 17/64 inch long-----	9
33169 A	Shoulder Screw, headless, 13/16 inch long, with .375 inch diameter shoulder 13/32 inch long-----	9
HA 42	Shoulder Screw, headless, 59/64 inch long, with .275 inch diameter shoulder 19/32 inch long-----	9
22845 D	Shoulder Screw, headless, 31/32 inch long, with .319 inch diameter shoulder 17/32 inch long-----	9
22845 K	Shoulder Screw, headless, 31/32 inch long over-all, with .406 inch diameter shoulder 17/32 inch long-----	9
99251	Hinge Screw, headless, 1 17/32 inches long, with .170 inch diameter shoulder 3/32 inch long, also with .140 inch diameter pilot 1 15/64 inches long-----	9
86 A	Shoulder Screw, fillister head, 19/64 inch long, with .220 inch diameter shoulder 9/64 inch long-----	16
92121	Shoulder Screw, fillister head, 23/64 inch long, with .232 inch diameter shoulder .146 inch long-----	16
22715	Shoulder Screw, fillister head, 3/8 inch long, with .319 inch diameter shoulder 9/64 inch long-----	16
9675	Shoulder Screw, fillister head, 1/2 inch long, with .247 inch diameter shoulder 1/4 inch long-----	16
11634 B	Shoulder Screw, fillister head, 1/2 inch long, with .247 inch diameter shoulder 17/64 inch long-----	16
22557	Shoulder Screw, fillister head, 1/2 inch long, with .319 inch diameter shoulder 9/64 inch long-----	16
22557 A	Shoulder Screw, fillister head, 1/2 inch long, with .257 inch diameter shoulder 1/4 inch long-----	16
22557 D	Shoulder Screw, fillister head, 35/64 inch long, with .319 inch diameter shoulder .360 inch long-----	16
35766	Shoulder Screw, fillister head, 35/64 inch long, with .250 inch diameter shoulder 1/4 inch long-----	14
9663	Shoulder Screw, fillister head, 37/64 inch long, with .220 inch diameter shoulder 9/64 inch long-----	16
C 38	Shoulder Screw, fillister head, 19/32 inch long, with .318 inch diameter shoulder .148 inch long-----	16
C 49	Shoulder Screw, fillister head, 19/32 inch long, with .346 inch diameter shoulder 9/32 inch long-----	16
35751 D	Shoulder Screw, fillister head, 19/32 inch long, with .250 inch diameter shoulder 1/4 inch long-----	16
22761	Shoulder Screw, fillister head, 23/32 inch long, with .281 inch diameter eccentric shoulder 1/8 inch long-----	18
22850	Shoulder Screw, fillister head, 47/64 inch long, with .318 inch diameter shoulder .137 inch long-----	16
236	Shoulder Screw, fillister head, 51/64 inch long, with .375 inch diameter shoulder 27/64 inch long-----	16
22557 E	Shoulder Screw, fillister head, 13/16 inch long, .375 inch diameter shoulder .442 inch long-----	16
41071 D	Shoulder Screw, hexagonal head, 13/16 inch long, with .319 inch diameter shoulder .370 inch long-----	18

CLASSIFIED LIST OF PARTS

<u>Part No.</u>	<u>Description</u>	<u>Page No.</u>
<u>.214-32 Thread (continued)</u>		
22557 B	Shoulder Screw, fillister head, 53/64 inch long, with double shoulder, 1/2 and 3/8 inch diameters, 13/64 inch and 3/16 inch long respectively -----	18
22777	Shoulder Screw, fillister head, 55/64 inch long, with .257 inch diameter shoulder .541 inch long -----	17
711	Shoulder Screw, fillister head, 7/8 inch long, with .375 inch diameter shoulder 29/64 inch long -----	17
22777 B	Shoulder Screw, hexagonal head, 7/8 inch long, with 1/4 inch diameter shoulder 17/32 inch long -----	18
461	Shoulder Screw, fillister head, 57/64 inch long, with flattened section, under head, and .250 inch diameter shoulder 13/32 inch long -----	17
HA42 A	Shoulder Screw, fillister head, 59/64 inch long, with .269 inch diameter shoulder 5/8 inch long -----	17
35735 B	Shoulder Screw, fillister head, 59/64 inch long, with .250 inch diameter shoulder 7/16 inch long -----	17
9253	Shoulder Screw, fillister head, 31/32 inch long, with .250 inch diameter shoulder 5/8 inch long -----	17
15162	Shoulder Screw, fillister head, 1 inch long, with .373 inch diameter shoulder 29/64 inch long and .311 inch diameter flattened shoulder 19/64 inch long -----	18
9463	Shoulder Screw, fillister head, 1 1/16 inches long with .250 inch diameter shoulder 49/64 inch long -----	16
15453	Shoulder Screw, fillister head, 1 1/16 inches long, with .312 inch diameter shoulder 5/8 inch long -----	9
453	Shoulder Screw, fillister head, 1 3/32 inches long, with .250 inch diameter shoulder 13/32 inch long -----	17
22777 A	Shoulder Screw, fillister head, 1 3/32 inches long, with .257 inch diameter shoulder .541 inch long -----	17
22779	Shoulder Screw, fillister head, 1 3/32 inches long, with .319 inch diameter shoulder 23/32 inch long -----	17
9665	Shoulder Screw, fillister head, 1 1/4 inches long, has special shoulder .415 inch diameter 1/2 inch long -----	12
21640 AC	Shoulder Screw, fillister head, 1 9/32 inches long, with .319 inch diameter shoulder 13/16 inch long -----	17
15453 E	Shoulder Screw, fillister head, 1 5/16 inches long, with .312 inch diameter shoulder 5/8 inch long -----	9
HA17 A	Shoulder Screw, fillister head, 1 7/16 inches long, with 5/16 inch diameter shoulder 1/4 inch long and .250 inch diameter shoulder 21/32 inch long -----	20
36236 J	Shoulder Stud, fillister head, 15/32 inch long, with .250 inch diameter shoulder .302 inch long -----	11
80696 H	Shoulder Stud, fillister head, 1 39/64 inches long, with .250 inch diameter shoulder 1 3/32 inch long -----	20
15852	Shoulder Stud, fillister head, 2 1/2 inches long over-all, with .310 inch diameter shoulder 1 15/16 inches long -----	9
22832 G	Shoulder Screw, hexagonal head, 1 1/8 inches long, with .319 inch diameter shoulder 11/16 inch long -----	18
483	Shoulder Screw, hexagonal head, 1 9/32 inches long, with .319 inch diameter shoulder 3/4 inch long -----	18
128 D-1	Shoulder Screw, countersunk head, 1 3/8 inches long, with .257 inch diameter shoulder 21/32 inch long, threaded end slotted-----	9
9263	Shoulder Screw, square head, 27/32 inch long, with .250 inch diameter shoulder 29/64 inch long -----	20
K68034	Shoulder Stud, square head, 1 1/8 inches long, with .250 inch diameter shoulder 53/64 inch long -----	20

CLASSIFIED LIST OF PARTS

<u>Part No.</u>	<u>Description</u>	<u>Page No.</u>
<u>.214-32 Thread (continued)</u>		
80696	Shoulder Stud, square head, 1 9/32 inches long, with .250 inch diameter shoulder 25/32 inch long-----	20
HS17 B	Take-up Lever Stud, 49/64 inch long, with .250 inch diameter shoulder 29/64 inch long-----	20
80566	Stitch Regulating Stud, 1 5/8 inches long, with .250 inch diameter shoulder 21/32 inch long-----	19
22549	Screw Pin, length over-all 9/16 inch-----	9
22837 B	Screw Pin, 1 1/8 inches long-----	8
12062 B	Screw Pin, 1 3/8 inches long over-all, with 7/16 inch diameter flange 1/8 inch thick-----	8
22577 B	Hinge Screw, 1 7/32 inches long, .140 inch diameter pilot 1 7/64 inches long-----	9
12982	Nut, hexagonal, 3/32 inch thick-----	21
15037 A	Nut, hexagonal, 3/32 inch thick-----	21
12538	Nut, hexagonal, 1/8 inch thick-----	21
18	Nut, hexagonal, 5/32 inch thick-----	21
2397 A	Nut, hexagonal, 5/32 inch thick-----	21
52841 H	Nut, hexagonal, 1/4 inch thick-----	21
43442 Q	Nut, hexagonal, 9/32 inch thick-----	20
HA18 A	Nut, hexagonal, 5/16 inch thick-----	21
18 A	Nut, circular, knurled, 5/32 inch thick-----	21
35766 A	Nut, circular, 15/64 inch thick-----	20
35766 B	Nut, circular, 15/64 inch thick-----	20
39141 G	Nut, circular, 17/64 inch thick, with .21/64 inch diameter shoulder 9/64 inch long-----	20
1347 A	Nut, circular, knurled, 9/32 inch thick-----	21
1032	Nut, circular, 5/16 inch thick-----	20
60038 N	Nut, round, 17/64 inch thick-----	20
43137	Stitch Regulator Nut-----	20
43237	Stitch Regulator Nut-----	20
52841 J	Nut, socket type, 21/64 inch thick-----	21
43143 E	Adjusting Nut, 1/2 inch long-----	20
<u>.216-22 Thread</u>		
<u>.216 inch diameter, 22 threads per inch; tap No. V115, tap drill No. 17 (.173 inch diameter)</u>		
22886	Plug Screw, headless, 5/16 inch long-----	6
22872	Screw, fillister head, 3/8 inch long-----	10
41378 D	Adapter Stud, hexagonal head, 5/16 inch long, with .146-40 thread in head 13/64 inch deep, tap No. V107-----	7
22598 C	Shoulder Screw, fillister head, 31/64 inch long, with 9/32 inch diameter shoulder 7/64 inch long-----	16
51192 J	Nut, hexagonal, 3/16 inch thick-----	21
43266	Nut, hexagonal, 1/4 inch thick-----	21
<u>.217-32 Left Thread</u>		
<u>.217 inch diameter, 32 threads per inch; tap No. V114, tap drill No. 13 (.185 inch diameter)</u>		
52998 K	Screw, countersunk head, 41/64 inch long-----	13
22888 A	Screw, countersunk head, 61/64 inch long-----	13
51236 C	Feed Crank Stud, 29/32 inches long-----	20
51236 G	Feed Crank Stud, 1 inch long-----	20
51136 D	Feed Crank Stud, 1 3/64 inches long-----	20
51136 E	Feed Crank Stud, 1 1/8 inches long-----	20
K68035	Shoulder Stud, square head, 1 1/8 inches long, with .250 inch diameter shoulder 53/64 inch long-----	20

CLASSIFIED LIST OF PARTS

<u>Part No.</u>	<u>Description</u>	<u>Page No.</u>
<u>.217-32 Left Thread (continued)</u>		
43242 P	Nut, hexagonal, 3/32 inch thick-----	21
269	Nut, hexagonal, 5/32 inch thick-----	21
51216 P	Nut, hexagonal, 5/32 inch thick-----	21
<u>7/32-32 Thread</u>		
<u>.218 inch diameter, 32 threads per inch; tap No. V244, tap drill No. 12 (.189 inch diameter)</u>		
1025 L	Screw, headless, 3/16 inch long-----	6
<u>.219-28 Thread</u>		
<u>.219 inch diameter, 28 threads per inch; tap No. V116, tap drill No. 13 (.185 inch diameter)</u>		
22714	Set Screw, headless, 15/32 inch long-----	7
22587 F	Screw, fillister head, 25/32 inch long-----	11
22587 C	Screw, fillister head, 1 1/16 inches long-----	11
12988 A	Screw, hexagonal head, 5/16 inch long-----	14
12988 B	Screw, hexagonal head, 25/64 inch long-----	14
22714 A	Screw, hexagonal head, 15/32 inch long-----	7
12993 A	Screw, hexagonal head, 1 inch long-----	14
G29	Screw, countersunk head, 5/8 inch long-----	13
11540	Screw, countersunk head, 1 1/32 inches long-----	13
33	Screw, countersunk head, 1 3/16 inches long-----	13
64 A	Thumbscrew, knurled head, 1 7/64 inches long-----	19
22789	Thumbscrew, knurled head, 1 3/16 inches long-----	19
641 C	Shoulder Screw, fillister head, 13/32 inch long, with .250 inch diameter shoulder 3/16 inch long-----	16
22587	Shoulder Screw, fillister head, 25/32 inch long, with .221 inch diameter shoulder 7/16 inch long-----	17
34	Nut, hexagonal, 5/32 inch thick-----	21
35169 A	Nut, hexagonal, 11/64 inch thick-----	21
15467 A	Nut, hexagonal, slotted, 1/4 inch thick-----	21
15887	Nut, hexagonal, slotted, 1/4 inch thick-----	21
64 B	Nut, circular, knurled, 1/4 inch thick-----	21
<u>.224-32 Thread</u>		
<u>.224 inch diameter, 32 threads per inch; tap No. V117, tap drill No. 10 (.1935 inch diameter)</u>		
22843 A	Screw, headless, 1 1/2 inches long-----	6
22891 A	Adapter Screw, fillister head, 7/32 inch long, with .110-50 internal thread in head, tap No. V102-----	7
22843	Thumbscrew, knurled, 1 1/16 inches long-----	20
22850 A	Shoulder Screw, fillister head, 47/64 inch long, with .317 inch diameter shoulder .137 inch long-----	16
61430 AZ	Nut, hexagonal, 1/8 inch thick-----	21
434	Nut, circular, knurled, 1/4 inch thick-----	21
51292 C	Nut, circular, knurled, 9/32 inch thick-----	21
108	Nut, circular, knurled, 5/16 inch thick-----	21
108 C	Nut, circular, knurled, chromium plated, 5/16 inch thick-----	21
433	Nut, circular, knurled, 25/64 inch thick-----	21
<u>No. 14-20 Thread</u>		
<u>.242 inch diameter, 20 threads per inch; tap No. V130, tap drill No. 10 (.1935 inch diameter)</u>		
22751	Spot Screw, headless, 17/32 inch long-----	6

CLASSIFIED LIST OF PARTS

<u>Part No.</u>	<u>Description</u>	<u>Page No.</u>
<u>No. 14-20 Thread (continued)</u>		
25 C	Screw, fillister head, 9/32 inch long -----	10
22514	Screw, fillister head, 7/16 inch long -----	10
22514 A	Screw, fillister head, 3/4 inch long -----	10
833	Screw, countersunk head, 23/32 inch long -----	13
834	Screw, countersunk head, 1 1/4 inches long -----	13
25	Thumbscrew, knurled head, 3/8 inch long -----	20
25 U	Thumbscrew, knurled head, 31/64 inch long -----	20
201 C	Thumbscrew, knurled head, 39/64 inch long -----	20
22551 A	Thumbscrew, knurled head, 5/8 inch long -----	20
G3	Thumbscrew, knurled head, 1 1/32 inches long -----	20
290	Thumbscrew, knurled head, 1 1/32 inches long -----	19
61245	Thumbscrew, knurled head, 5 inches long -----	19
22547	Screw, round head, 5/8 inch long -----	13
119 A	Shoulder Screw, fillister head, 35/64 inch long, with .304 inch diameter shoulder .207 inch long -----	16
80003 A-5	Shoulder Screw, fillister head, 23/32 inch long, with .306 inch diameter shoulder 25/64 inch long -----	17
<u>1/4-32 Thread</u>		
<u>.250 inch diameter, 32 threads per inch; tap No. V140, tap drill 7/32 (.2187 inch diameter)</u>		
22586 B	Screw, headless, 1/8 inch long -----	6
22586 R	Screw, fillister head, 7/16 inch long -----	10
<u>1/4-28 Thread</u>		
<u>.250 inch diameter, 28 threads per inch; tap No. V146, tap drill No. 3 (.213 inch diameter)</u>		
22651 CD-3	Set Screw, headless, socket type, cup point, 3/16 inch long -----	7
22651 CD-4	Set Screw, headless, socket type, cup point, 1/4 inch long -----	7
22651 CD-5	Set Screw, headless, socket type, cup point, 5/16 inch long -----	7
22894	Spot Screw, headless, socket type, cone point, 5/16 inch long -----	7
22653 D-4	Cap Screw, fillister head, socket type, 1/4 inch long -----	12
22653 D-8	Cap Screw, fillister head, socket type, 1/2 inch long -----	12
22653 D-24	Cap Screw, fillister head, socket type, 1 1/2 inches long -----	12
22896	Screw, hexagonal head, 3 33/64 inches long, with .308-24 threaded section near center of screw and 1/4-28 thread at end -----	15
22645 H-48	Cap Screw, hexagonal head, 3/4 inch long -----	14
22645 H-64	Cap Screw, hexagonal head, 1 inch long -----	14
22823	Screw, slotted, countersunk hexagonal head, 37/64 inch long -----	13
22823 A	Screw, slotted, countersunk hexagonal head, 11/16 inch long -----	13
22823 C	Screw, slotted, countersunk hexagonal head, 1 1/16 inches long -----	13
22823 B	Screw, slotted, countersunk hexagonal head, 1 1/4 inches long -----	13
<u>1/4-24 Thread</u>		
<u>.250 inch diameter, 24 threads per inch; tap No. V298, tap drill No. 4 (.209 inch diameter)</u>		
22586 D	Set Screw, headless, 3/8 inch long -----	6
<u>1/4-20 Thread</u>		
<u>.250 inch diameter, 20 threads per inch; tap No. V133, tap drill No. 7 (.201 inch diameter)</u>		
22620 H-16	Set Screw, headless, 1/4 inch long -----	6
22650 AD-4	Set Screw, headless, socket type, flat point, 1/4 inch long -----	7
22650 CD-4	Set Screw, headless, socket type, cup point, 1/4 inch long -----	7

CLASSIFIED LIST OF PARTS

<u>Part No.</u>	<u>Description</u>	<u>Page No.</u>
-----------------	--------------------	-----------------

1/4-20 Thread (continued)

22620 H-20	Set Screw, headless, 5/16 inch long-----	6
22650 CD-6	Set Screw, headless, socket type, cup point, 3/8 inch long-----	7
22539 L	Plug Screw, headless, 1/4 inch long-----	6
AS25	Screw, fillister head, 41/64 inch long-----	11
22615	Cap Screw, fillister head, 1/2 inch long-----	11
22616	Cap Screw, fillister head, 3/4 inch long-----	11
22617	Cap Screw, fillister head, 1 inch long-----	11
22652 D-6	Cap Screw, fillister head, socket type, 3/8 inch long-----	12
22652 D-12	Cap Screw, fillister head, socket type, 3/4 inch long-----	12
22652 D-20	Cap Screw, fillister head, socket type, 1 1/4 inches long-----	12
22640 H-32	Cap Screw, hexagonal head, 1/2 inch long-----	14
22640 H-128	Cap Screw, hexagonal head, 2 inches long-----	14
22637 H-48	Machine Screw, countersunk head, 3/4 inch long-----	13
99112	Machine Screw, countersunk head, 1 inch long-----	13
22635	Machine Screw, round head, 1/2 inch long-----	13
G13	Cap Screw, round head, 5/8 inch long-----	13
22507	Set Screw, square head, 3/8 inch long-----	15
22508	Set Screw, square head, 1/2 inch long-----	15
22510	Set Screw, square head, 5/8 inch long-----	15
22626	Set Screw, square head, cup point, 5/8 inch long-----	15
20237	Shoulder Screw, hexagonal head, 29/32 inch long, with .375 inch diameter shoulder 13/32 inch long-----	18
21369 A	Wing Nut-----	21

.255-40 Thread

.255 inch diameter, 40 threads per inch; tap No. V92, tap drill No. "A" (.234 inch diameter)

22894 X	Set Screw, headless, socket type, 3/16 inch long-----	7
22894 F	Set Screw, headless, socket type, 5/16 inch long-----	7
22894 V	Set Screw, headless, socket type, 7/16 inch long-----	7
22894 N	Spot Screw, headless, socket type, 9/32 inch long-----	7
22884	Screw, fillister head, 5/16 inch long-----	10
22884 A	Screw, fillister head, 9/16 inch long-----	10
22884 B	Spot Screw, fillister head, 43/64 inch long-----	14
22866 G	Screw, hexagonal head, 5/16 inch long-----	14
22882 B	Spot Screw, hexagonal head, 7/16 inch long-----	14
22845 F	Shoulder Screw, headless, 1/2 inch long, with .319 inch diameter shoulder 17/64 inch long-----	9
375	Nut, hexagonal, 1/8 inch thick-----	21
55235 E	Nut, hexagonal, 7/32 inch thick-----	21

.257-32 Thread

.257 inch diameter, 32 threads per inch; tap No. V118, tap drill No. 1 (.228 inch diameter)

22586	Screw, headless, 1/8 inch long-----	6
22586 A	Screw, headless, 5/32 inch long, with oil hole through center-----	7
74 E	Screw, headless, 9/32 inch long-----	6
21725	Screw, headless, 19/64 inch long, with oil hole through center-----	7
22591	Screw, headless, 5/16 inch long-----	6
K42171	Screw, headless, .533 inch long-----	6
22537	Screw, headless, 35/64 inch long-----	6
22533	Screw, headless, 55/64 inch long-----	9
22533 A	Screw, headless, 7/8 inch long-----	6
562	Screw, headless, 1 7/8 inches long over-all, with pilot 1 5/16 inches long-----	9

CLASSIFIED LIST OF PARTS

<u>Part No.</u>	<u>Description</u>	<u>Page No.</u>
<u>.257-32 Thread (continued)</u>		
15455	Screw, headless, 2 5/16 inches long over-all, with pilot 1 5/8 inches long -----	9
35833 A	Screw, headless, 2 11/32 inches long -----	6
22591 A	Set Screw, headless, cup point, 5/16 inch long -----	6
HA95	Set Screw, headless, 3/8 inch long-----	6
22894 G	Set Screw, headless, socket type, 5/8 inch long -----	7
HA81	Spot Screw, headless, 29/64 inch long-----	6
22590	Spot Screw, headless, 17/32 inch long-----	6
22590 A	Spot Screw, headless, 9/16 inch long, cone point -----	6
772	Spot Screw, headless, 13/16 inch long-----	6
22844	Screw Pin, headless, 2 1/2 inches long, with .125 inch diameter pilot 1 1/2 inches long-----	9
22577 A	Adjusting Screw, headless, 7/8 inch long, with .110-50 internal thread, tap No. V102-----	7
92022	Screw, fillister head, 25/64 inch long -----	11
22891	Screw, fillister head, 15/32 inch long -----	11
22570 C	Screw, fillister head, 19/32 inch long -----	10
22806 A	Screw, fillister head, 21/32 inch long -----	11
22750	Screw, fillister head, 3/4 inch long -----	10
318	Screw, fillister head, 25/32 inch long -----	11
820	Screw, fillister head, 1 1/16 inches long -----	11
1279	Screw, fillister head, 1 3/16 inches long -----	12
22806 G	Screw, fillister head, socket type, 1 1/4 inches long-----	12
22806	Screw, fillister head, 1 9/32 inches long -----	11
821	Screw, fillister head, 2 11/16 inches long -----	12
53636 A	Feed Driving Arm Stud, fillister head, 1 1/8 inch long -----	20
22866	Screw, hexagonal head, 11/32 inch long -----	14
BP108	Screw, hexagonal head, 35/64 inch long -----	14
22759	Screw, hexagonal head, 19/32 inch long -----	14
22811	Screw, hexagonal head, 3/4 inch long -----	14
22811 B	Screw, hexagonal head, 3/4 inch long -----	14
74 A	Screw, hexagonal head, 13/16 inch long -----	14
157	Screw, hexagonal head, 1 7/64 inches long-----	14
22759 A	Screw, hexagonal head, 1 19/64 inches long-----	14
22841 C	Screw Post, hexagonal, 1 19/32 inches long, internal thread .214-32, 9/16 inch deep, tap No. V113-----	8
22521	Screw, countersunk head, 1/2 inch long -----	13
22754	Screw, countersunk head, 5/8 inch long -----	13
22728	Thumbscrew, knurled head, 3/8 inch long -----	19
G42	Thumbscrew, 15/32 inch long -----	20
22789 B	Thumbscrew, knurled head, 1 3/4 inches long over-all, with 1/4 inch long pilot -----	7
22789 A	Thumbscrew, knurled head, 1 15/16 inches long-----	19
64 Y	Thumbscrew, 2 1/4 inches long-----	19
51235 P	Thumbscrew, knurled head, 3 3/4 inches long-----	19
22591 G	Screw, square head, cup point, 5/8 inch long -----	15
22752 B	Screw, capstan head, 5/16 inch long -----	7
22802	Shoulder Screw, headless, 29/32 inch long, with 3/8 inch diameter shoulder 33/64 inch long -----	9
22870	Shoulder Screw, headless, 1 1/16 inches long, with 5/16 inch diameter shoulder 45/64 inch long -----	9
14791	Shoulder Screw, headless, 1 19/64 inches long, with .312 inch diameter shoulder 3/4 inch long -----	9
15498 L	Shoulder Screw, headless, 2 3/8 inches long, 5/16 inch diameter shoulder 2 inches long-----	8
35172 C	Screw Pin, headless, 31/32 inch long, with .408 inch diameter shoulder 31/64 inch long-----	9

CLASSIFIED LIST OF PARTS

<u>Part No.</u>	<u>Description</u>	<u>Page No.</u>
	<u>.257-32 Thread (continued)</u>	
11638 A	Screw Pin, headless, 1 inch long, with .375 inch diameter shoulder 1/2 inch long-----	9
11637 A	Screw Pin, headless, 1 1/8 inches long, with .312 inch diameter shoulder 7/16 inch long-----	9
11639 H	Screw Pin, headless, 1 7/32 inches long, with .375 inch diameter shoulder 3/4 inch long-----	9
23451 G	Shoulder Stud, headless, 2 7/16 inches long, with .625 inch diameter shoulder 1 11/16 inches long-----	9
22523	Shoulder Screw, fillister head, 5/16 inch long, with .267 inch diameter shoulder 9/64 inch long-----	11
HA86 A	Shoulder Screw, fillister head, 17/32 inch long, with .319 inch diameter shoulder 17/64 inch long-----	16
22854	Shoulder Screw, fillister head, 23/32 inch long, with .312 inch diameter shoulder .340 inch long-----	16
22720	Shoulder Screw, fillister head, 3/4 inch long, with .330 inch diameter shoulder 3/16 inch long, with .146-40 thread, tap No. V107, cross hole in shoulder-----	18
11638 F	Shoulder Screw, fillister head, 27/32 inch long, with .375 inch diameter shoulder 3/8 inch long-----	16
11639 A	Shoulder Screw, fillister head, 7/8 inch long, with .375 inch diameter shoulder 5/32 inch long-----	16
22854 A	Shoulder Screw, fillister head, 7/8 inch long, with 3/8 inch diameter shoulder .378 inch long-----	17
35737 C	Shoulder Screw, fillister head, 29/32 inch long, with .259 inch diameter shoulder 13/32 inch long-----	10
22857	Shoulder Screw, fillister head, 1 1/16 inches long, with .319 inch diameter shoulder .378 inch long-----	18
257	Shoulder Screw, fillister head, 1 3/16 inches long, with .375 inch diameter shoulder 3/8 inch long-----	16
12655 A	Shoulder Screw, fillister head, 1 1/4 inches long, with .375 inch diameter shoulder 3/4 inch long-----	18
35737 D	Shoulder Screw, fillister head, 1 3/8 inches long, with .259 inch diameter shoulder 19/64 inch long, also with .199 inch diameter pilot 53/64 inch long-----	7
30036	Shoulder Screw, fillister head, 1 29/32 inches long, with .264 inch diameter shoulder 1 19/32 inches long-----	17
22857 A	Shoulder Screw, hexagonal head, 25/32 inch long, with .319 inch diameter shoulder .378 inch long-----	18
22857 B	Shoulder Screw, slotted, hexagonal head, 31/32 inch long, with 3/8 inch diameter shoulder .377 inch long-----	18
23437 E	Thumbscrew, 1 47/64 inches long, with .375 inch shoulder 3/4 inch long-----	19
6042	Shoulder Stud, square head, 1 3/16 inches long, 11/16 inch of thread--	20
6939	Shoulder Stud, square head, 1 5/16 inches long, 11/16 inch of thread--	20
35572 B	Feed Block Stud, beveled head, 47/64 inch long, with .319 inch diameter shoulder 13/32 inch long-----	18
15862 H	Adaptor Screw, hexagonal head, 1 1/4 inches long, shoulder 55/64 inch long with .182-40 internal thread 1/2 inch deep-----	8
53657 A	Cast-off Plate Stud, 2 inches long, with .146-40 internal thread, 1/2 inch deep, tap No. V107-----	7
51280 E	Throat Plate Support Pin, 2 1/2 inches long, with pilot 1 5/8 inches long-----	9
51080 A	Throat Plate Support Pin, 2 13/16 inches long-----	8
22579	Screw Eye, 1 1/4 inches long-----	19
12656 E	Screw Eye, 1 3/4 inches long, with .214-32 thread at bottom of screw eye 19/32 inch long-----	19
12987 A	Nut, hexagonal, 5/64 inch thick-----	21
258 A	Nut, hexagonal, 1/8 inch thick-----	21

CLASSIFIED LIST OF PARTS

<u>Part No.</u>	<u>Description</u>	<u>Page No.</u>
<u>.257-32 Thread (continued)</u>		
258	Nut, hexagonal, 11/64 inch thick-----	21
30150	Nut, hexagonal, 13/64 inch thick-----	21
80691	Nut, hexagonal, 7/32 inch thick-----	20
1280	Nut, hexagonal, 15/64 inch thick-----	21
51246	Nut, hexagonal, 3/8 inch thick-----	21
61292 C	Nut, circular, knurled, 3/16 inch thick-----	21
35733 B	Nut, circular, knurled, 9/32 inch thick-----	21
16369 D	Nut, circular, knurled, 25/64 inch thick-----	21
38241 U	Nut, circular, 13/32 inch thick-----	20
43137 D	Nut, stitch regulator -----	20
<u>5/16-32 Thread</u>		
<u>.312 inch diameter, 32 threads per inch; tap No. V93, tap drill 9/32 (.2812 inch diameter)</u>		
39157 K	Nut, circular, knurled, 1/8 inch thick-----	21
<u>5/16-24 Thread</u>		
<u>.312 inch diameter, 24 threads per inch; tap No. V185, tap drill "I" (.272 inch diameter)</u>		
22822	Hinge Screw, headless, 1 inch long -----	7
22653 E-12	Cap Screw, fillister head, socket type, 3/4 inch long -----	12
22653 E-20	Cap Screw, fillister head, socket type, 1 1/4 inches long, 1 inch of thread-----	12
22538	Cap Screw, fillister head, 1 1/2 inches long -----	11
22820 H	Screw, hexagonal head, 1 inch long -----	18
22644 K-64	Cap Screw, hexagonal head, 1 inch long -----	14
22644 K-80	Cap Screw, hexagonal head, 1 1/4 inches long-----	14
22712 N	Shoulder Screw, fillister head, 1/2 inch long, with .374 inch diameter shoulder .189 inch long -----	16
22712 G	Shoulder Screw, fillister head, 27/32 inch long, with 3/8 inch diameter shoulder 15/32 inch long -----	17
22712 A	Shoulder Screw, fillister head, 29/32 inch long, with .407 inch diameter shoulder .412 inch long -----	17
22854 D	Shoulder Screw, fillister head, 1 1/16 inches long, with .407 inch diameter shoulder 23/32 inch long -----	17
22854 C	Shoulder Screw, fillister head, 1 5/32 inches long, with .407 inch diameter shoulder .722 inch long -----	17
22712 F	Shoulder Screw, fillister head, 1 9/32 inches long, with .375 inch diameter shoulder 21/32 inch long -----	17
39295	Base Plate Stud, 1 1/8 inches long over-all, with 3/8 inch threaded portion under hexagonal flange -----	8
51257 J	Cap Nut, hexagonal, 5/8 inch long -----	20
<u>5/16-18 Thread</u>		
<u>.312 inch diameter, 18 threads per inch; tap No. V134, tap drill "F" (.257 inch diameter)</u>		
22650 AE-4	Set Screw, headless, socket type, flat point, 1/4 inch long-----	7
22650 AE-6	Set Screw, headless, socket type, flat point, 3/8 inch long -----	7
22650 CE-6	Set Screw, headless, socket type, cup point, 3/8 inch long -----	7
22622	Set Screw, headless, cup point, 1/2 inch long -----	6
22627 A	Set Screw, headless, 5/8 inch long-----	6
22620 K-64	Set Screw, headless, cup point, 1 inch long -----	6
22815	Spot Screw, headless, 5/8 inch long-----	6
22621 K-48	Spot Screw, headless, cone point, 3/4 inch long -----	6
22814 B	Screw, fillister head, 3/4 inch long-----	11

CLASSIFIED LIST OF PARTS

<u>Part No.</u>	<u>Description</u>	<u>Page No.</u>
<u>5/16-18 Thread (continued)</u>		
T32	Screw, fillister head, 13/16 inch long-----	11
22814	Screw, fillister head, 1 7/32 inches long -----	11
22871	Screw, fillister head, 2 3/4 inches long -----	12
22652 E-14	Cap Screw, fillister head, socket type, 7/8 inch long -----	12
22810	Cap Screw, fillister head, 1 inch long -----	11
22652 E-20	Cap Screw, fillister head, socket type, 1 1/4 inches long-----	12
22642 K-32	Cap Screw, hexagonal head, 1/2 inch long-----	14
22642 K-48	Cap Screw, hexagonal head, 3/4 inch long -----	14
22642	Cap Screw, hexagonal head, 1 inch long -----	14
22642 K-80	Cap Screw, hexagonal head, 1 1/4 inches long, 7/8 inch of thread ----	14
22642 K-104	Cap Screw, hexagonal head, 1 5/8 inches long -----	14
22642 K-112	Cap Screw, hexagonal head, 1 3/4 inches long-----	14
22637 K-24	Machine Screw, countersunk head, 3/8 inch long -----	13
22637	Machine Screw, countersunk head, 1 inch long -----	13
22637 F	Machine Screw, countersunk head, 1 1/4 inches long-----	13
22637 A	Machine Screw, countersunk head, 1 1/2 inches long-----	13
22637 D	Machine Screw, countersunk head, 1 3/4 inches long-----	13
22637 B	Machine Screw, countersunk head, 2 1/2 inches long-----	13
69 FD	Set Screw, square head, cup point, 5/8 inch long -----	15
22509	Set Screw, square head, cup point, 5/8 inch long -----	15
22624 K-40	Set Screw, square head, 5/8 inch long-----	15
22627	Set Screw, square head, cup point, 3/4 inch long -----	15
22643 K-64	Set Screw, square head, cup point, 1 inch long -----	15
22649 K-96	Set Screw, square head, round point, 1 1/2 inches long -----	15
22647 K-48	Thumbscrew, 3/4 inch long -----	20
28509	Shoulder Screw, fillister head, 29/32 inch long, with .373 inch diameter shoulder .409 inch long -----	17
28509 A	Shoulder Screw, fillister head, 1 1/4 inches long, with .375 inch diameter shoulder 3/8 inch long -----	17
42 B	Shoulder Screw, fillister head, 1 7/16 inches long, with .406 inch diameter shoulder 59/64 inch long -----	18
20237 A	Shoulder Screw, hexagonal head, 29/32 inch long, with .375 inch diameter shoulder 13/32 inch long -----	18
22817 B	Shoulder Screw, hexagonal head, 1 21/32 inches long, has special shoulder 7/16 inch diameter 1/4 inch long -----	18
22701	Adjusting Screw, 2 3/4 inches long-----	8
21104 H	Nut, hexagonal, 7/32 inch thick-----	21
G15	Nut, hexagonal, 5/16 inch thick-----	21
28509 B	Nut, hexagonal, 5/16 inch thick-----	21
11698 Q	Nut, square, 5/16 inch thick -----	20

.314-24 Thread

.314 inch diameter, 24 threads per inch; tap No. V119, tap
drill "I" (.272 inch diameter)

22706	Screw, headless, 7/32 inch long-----	6
22706 A	Screw, headless, 1/4 inch long -----	6
22847	Screw, fillister head, 1 1/4 inches long -----	10
11638 J	Screw, fillister head, threaded end slotted, 1 5/8 inches long-----	12
11638 N	Stud, fillister head, 2 9/16 inches long, threaded end slotted -----	12
22788	Screw, hexagonal head, 29/32 inch long -----	14
G39	Screw, countersunk head, 1 inch long -----	13
21754	Shoulder Screw, fillister head, 47/64 inch long, with .530 inch diameter shoulder 3/8 inch long -----	16
420	Shoulder Screw, fillister head, 1 35/64 inches long, with .437 inch diameter shoulder 1 1/16 inches long -----	17
22712	Shoulder Screw, fillister head, 1 11/16 inches long, with 7/16 inch diameter shoulder 1 1/16 inches long -----	17

CLASSIFIED LIST OF PARTS

<u>Part No.</u>	<u>Description</u>	<u>Page No.</u>
<u>.314-24 Thread (continued)</u>		
420 C	Shoulder Screw, fillister head, 2 3/16 inches long, with .437 inch diameter shoulder 1 1/64 inches long -----	17
22879	Shoulder Screw, fillister head, 5 inches long, with .437 inch diameter shoulder .705 inch long -----	18
11638 M	Nut, hexagonal, 1/8 inch thick-----	21
11635 B	Nut, hexagonal, 13/64 inch thick-----	21
420 B	Nut, hexagonal, 1/4 inch thick-----	21
15433	Nut, hexagonal, 21/64 inch thick-----	20
<u>.367-28 Left Thread</u>		
<u>.367 inch diameter, 28 threads per inch; tap No. V94, tap drill No. "Q" (.332 inch diameter)</u>		
12982 A	Screw Bushing, hexagonal head, .214-32 internal thread, tap No. V113 -----	7
<u>.368-24 Thread</u>		
<u>.368 inch diameter, 24 threads per inch; tap No. V119 A, tap drill 21/64 (.328 inch diameter)</u>		
22571 D	Screw, headless, 1/8 inch long -----	6
22571 A	Screw, headless, 9/32 inch long -----	6
92128	Screw, headless, 23/64 inch long, with hole through center-----	7
22537 A	Set Screw, headless, 3/4 inch long-----	6
22889 C	Adaptor Plug Screw, headless, 9/16 inch long, with pilot .300 inch diameter 1/4 inch long, internal thread .182-40, tap No. V109 -----	7
22889 D	Adaptor Plug Screw, headless, 5/8 inch long, internal thread .182-40, tap No. V109 -----	7
22733 B	Plug Screw, fillister head, 1/4 inch long -----	12
22889 B	Adaptor Plug Screw, fillister head, 3/8 inch long, .216-22 internal thread, tap No. V115-----	7
41478	Adaptor Stud, hexagonal head, 3/8 inch long, with .216-22 thread in head 1/4 inch deep, tap No. V115 -----	7
22566 B	Shoulder Screw, fillister head, 1 1/16 inches long, with .437 inch diameter shoulder 5/8 inch long -----	17
22566 A	Shoulder Screw, fillister head, 1 5/32 inches long, with .499 inch diameter shoulder 9/16 inch long -----	17
22566 C	Shoulder Screw, fillister head, 1 3/8 inches long, with .499 inch diameter shoulder 9/16 inch long -----	17
22865	Shoulder Screw, fillister head, 1 7/16 inches long, with .407 inch diameter shoulder 15/16 inch long -----	17
22566	Shoulder Screw, fillister head, 1 9/16 inches long, with .437 inch diameter shoulder 1 1/16 inches long -----	17
11635 E	Shoulder Screw, fillister head, 1 23/32 inches long, with 3/8 inch diameter shoulder 9/16 inch long-----	17
22865 A	Shoulder Screw, fillister head, 1 3/4 inches long, with .407 inch diameter shoulder 1 5/16 inches long -----	17
22817 C	Shoulder Screw, hexagonal head, 15/16 inch long, with .500 inch diameter shoulder .531 inch long -----	18
22817 A	Shoulder Screw, hexagonal head, 1 5/16 inches long, with .435 inch diameter shoulder .815 inch long -----	18
22885	Adaptor Plug Screw, 1/4 inch long, .214-32 internal thread, tap No. V113 -----	7
22889 A	Adaptor Plug Screw, 3/8 inch long, .182-40 internal thread, tap No. V109-----	7
11635 F	Nut, hexagonal, 7/32 inch thick -----	21
80630 D	Nut, hexagonal, 7/32 inch thick -----	21
30078	Nut, hexagonal, 1/4 inch thick -----	21

CLASSIFIED LIST OF PARTS

<u>Part No.</u>	<u>Description</u>	<u>Page No.</u>
<u>.368-24 Thread (continued)</u>		
G57 A	Nut, hexagonal, 3/8 inch thick -----	21
15430 D	Nut, hexagonal, 25/64 inch thick-----	20
35857 D	Lock Nut, circular, 7/64 inch thick -----	21
30077	Nut, circular, 1/4 inch thick -----	21
21711	Nut, circular, 3/8 inch thick -----	20
<u>.368-24 Left Thread</u>		
<u>.368 inch diameter, 24 threads per inch; tap No. V95, tap drill 21/64 (.328 inch diameter)</u>		
22890 A	Shoulder Screw, fillister head, 11/16 inch long, with .437 inch diameter shoulder .180 inch long -----	17
22890	Shoulder Screw, fillister head, 31/32 inch long, with .437 inch diameter shoulder .439 inch long -----	18
80630 C	Nut, hexagonal, 7/32 inch thick-----	21
15430 C	Nut, hexagonal, 25/64 inch thick-----	20
<u>3/8-24 Thread</u>		
<u>.375 inch diameter, 24 threads per inch; tap No. V186, tap drill "Q" (.332 inch diameter)</u>		
22653 F-16	Cap Screw, fillister head, socket type, 1 inch long -----	12
22653 F-20	Cap Screw, fillister head, socket type, 1 1/4 inches long-----	12
22653 F-40	Cap Screw, fillister head, socket type, 2 1/2 inches long, 1 1/16 inches of thread -----	12
<u>3/8-16 Thread</u>		
<u>.375 inch diameter, 16 threads per inch; tap No. V132, tap drill 5/16 (.3125 inch diameter)</u>		
22650 AF-8	Screw, headless, socket type, flat point, 1/2 inch long-----	7
22536	Set Screw, headless, 5/16 inch long-----	6
22620 M-24	Set Screw, headless, cup point, 3/8 inch long -----	6
22620	Set Screw, headless, 1/2 inch long-----	6
22650 CF-10	Set Screw, headless, socket type, cup point, 5/8 inch long -----	7
22621	Set Screw, headless, 3/4 inch long-----	6
22621 M-48	Spot Screw, headless, cone point, 3/4 inch long -----	6
22621 M-96	Spot Screw, headless, cone point, 1 1/2 inches long -----	6
51170 C	Adaptor Screw, headless, 3/4 inch long, with hole through center --	8
22617 M-48	Cap Screw, fillister head, 3/4 inch long -----	12
22617 M-64	Cap Screw, fillister head, 1 inch long -----	12
22617 A	Cap Screw, fillister head, 1 1/4 inches long -----	12
22652 F-20	Cap Screw, fillister head, socket type, 1 1/4 inches long-----	12
22617 M-112	Cap Screw, fillister head, 1 3/4 inches long -----	12
22652 F-32	Cap Screw, fillister head, socket type, 2 inches long -----	12
22618	Cap Screw, fillister head, 2 1/4 inches long -----	12
22640 M-32	Cap Screw, hexagonal head, 1/2 inch long -----	14
22603	Cap Screw, hexagonal head, 3/4 inch long -----	15
22604	Cap Screw, hexagonal head, 1 inch long -----	15
22605	Cap Screw, hexagonal head, 1 1/4 inches long-----	15
22640 M-96	Cap Screw, hexagonal head, 1 1/2 inches long-----	14
22640	Cap Screw, hexagonal head, 1 3/4 inches long-----	14
22820	Cap Screw, hexagonal head, 1 3/4 inches long-----	14
22641	Cap Screw, hexagonal head, 2 inches long -----	14
22640 M-144	Cap Screw, hexagonal head, 2 1/4 inches long-----	14
22638 B	Machine Screw, countersunk head, 3/4 inch long -----	13
22638	Machine Screw, countersunk head, 1 1/4 inches long-----	13
22637 M-96	Machine Screw, countersunk head, 1 1/2 inches long-----	13

CLASSIFIED LIST OF PARTS

<u>Part No.</u>	<u>Description</u>	<u>Page No.</u>
<u>3/8-16 Thread (continued)</u>		
22637 M-144	Machine Screw, countersunk head, 2 1/4 inches long-----	13
22509 A	Set Screw, square head, flat point, 5/8 inch long-----	15
22628 M-40	Set Screw, square head, 5/8 inch long-----	15
22628	Set Screw, square head, 3/4 inch long-----	15
22628 A	Set Screw, square head, 1 inch long-----	15
22629	Set Screw, square head, 1 1/4 inches long-----	15
22630	Set Screw, square head, 1 1/2 inches long-----	15
22733 A	Screw, round head, 17/64 inch long-----	13
38292 G	Shoulder Screw, headless, 2 inches long, with 1/2 inch diameter shoulder 1 1/4 inches long-----	9
38295	Stud, headless, 3 inches long, with 1/4 inch long hexagonal flange, 5/8 inch diameter shoulder 3/8 inch long, and .375 inch diameter shoulder 1 9/16 inches long, .312-18 thread, tap No. V134, thread above flange-----	8
80575	Shoulder Screw, fillister head, 2 1/4 inches long, with .437 inch diameter shoulder 1 1/16 inches long-----	17
22654	Shoulder Screw, fillister head, socket type, 3 3/8 inches long, with 1/2 inch diameter shoulder 2 3/4 inches long-----	18
20263	Shoulder Screw, hexagonal head, 1 25/32 inches long, with 1/2 inch diameter shoulder 1 1/32 inches long-----	18
22841 F	Table Board Adaptor, 7/8 inch hexagonal, 1 5/8 inches long, with 3/8-16 internal thread both ends-----	8
21697 M	Adjusting Screw, with screw eye, 3 15/32 inches long over-all-----	8
51170 D	Nut, hexagonal, 9/64 inch thick-----	21
80576	Nut, hexagonal, 7/32 inch thick-----	21
11698 L	Nut, hexagonal, 3/8 inch thick-----	21
21371 LR	Cap Nut, hexagonal, 3/4 inch long-----	20
21371 CT	Cap Nut, circular, with slotted countersunk head, 7/8 inch long-----	21

.404-16 Thread

.404 inch diameter, 16 threads per inch; tap No. V122, tap
drill 11/32 (.3437 inch diameter)

22571	Screw, headless, 3/8 inch long-----	6
99256	Screw, fillister head, 27/32 inch long-----	12
21352	Screw, fillister head, 1 1/2 inches long-----	12
21352 B	Screw, fillister head, 1 3/4 inches long-----	12
21352 A	Screw, fillister head, 2 inches long-----	12
21352 C	Screw, fillister head, 3 inches long-----	12
22639 C	Cap Screw, hexagonal head, 1 1/4 inches long-----	14
22639 B	Cap Screw, hexagonal head, 1 1/2 inches long-----	14
22639	Cap Screw, hexagonal head, 2 inches long-----	14
22639 A	Cap Screw, hexagonal head, 5 inches long-----	(-)
21681 B	Machine Bed Screw, 5 3/8 inches long-----	19
21681	Machine Bed Screw, 5 5/8 inches long-----	19
HA21681	Machine Bed Screw, 6 15/32 inches long-----	19
5480	Machine Clamp Screw, 5 3/4 inches long over-all-----	19
105-1 1/2	Table Screw, 1 1/2 inches long-----	19
105-2 1/2	Table Screw, 2 1/2 inches long-----	19
105-3	Table Screw, 3 inches long-----	19
105-3 1/2	Table Screw, 3 1/2 inches long-----	19
105-4	Table Screw, 4 inches long-----	19
105-4 1/2	Table Screw, 4 1/2 inches long-----	19
105-5	Table Screw, 5 inches long-----	19
105-5 1/2	Table Screw, 5 1/2 inches long-----	19
105-6	Table Screw, 6 inches long-----	19

NOTE: A Dash (-) in the "Page No." column denotes the absence of an illustration.

CLASSIFIED LIST OF PARTS

<u>Part No.</u>	<u>Description</u>	<u>Page No.</u>
	<u>.414-16 Thread</u>	
	<u>.414 inch diameter, 16 threads per inch; tap No. V123, tap drill "T" (.358 inch diameter)</u>	
22840	Adapter Screw, headless, 3/8 inch long, internal thread .182-40, tap No. V109 -----	7
22840 B	Adapter Screw, headless, 3/8 inch long, internal thread .216-22, tap No. V115 -----	7
47	Nut, hexagonal, 5/16 inch thick-----	21
	<u>.437-28 Thread</u>	
	<u>.437 inch diameter, 28 threads per inch; tap No. V193, tap drill "X" (.397 inch diameter)</u>	
22539 K	Screw, headless, 5/32 inch long-----	6
21237 W	Cap Nut, hexagonal, 1 5/32 inch long-----	20
	<u>7/16-27 Thread</u>	
	<u>.437 inch diameter, 27 threads per inch; tap No. V160, tap drill "Y" (.404 inch diameter)</u>	
22899	Screw, headless, 7/8 inch long-----	7
22539 M	Plug Screw, headless, 3/8 inch long-----	6
22841 B	Screw Post, hexagonal, 3 5/8 inches long, 9/16 inch deep .214-32 internal thread, tap No. V113 -----	8
22841 E	Adapter Stud, 3 5/8 inches long, 9/16 inch deep .214-32 internal thread, tap No. V113-----	8
39557 F	Nut, hexagonal, 3/32 inch thick-----	21
	<u>7/16-14 Thread</u>	
	<u>.437 inch diameter, 14 threads per inch; tap No. V135, tap drill "U" (.368 inch diameter)</u>	
22617 P-48	Cap Screw, fillister head, 3/4 inch long-----	12
22640 P-80	Cap Screw, hexagonal head, 1 1/4 inches long-----	(-)
22640 P-96	Cap Screw, hexagonal head, 1 1/2 inches long-----	(-)
22631	Set Screw, square head, 7/8 inch long-----	15
20243	Shoulder Screw, hexagonal head, 7/8 inch long, with .467 inch diameter shoulder 3/8 inch long-----	18
	<u>1/2-20 Thread</u>	
	<u>.500 inch diameter, 20 threads per inch; tap No. V242, tap drill 29/64 (.453 inch diameter)</u>	
22653 H-20	Cap Screw, fillister head, socket type, 1 1/4 inches long-----	12
22640 R-112	Cap Screw, hexagonal head, 1 3/4 inches long-----	14
20271	Nut, hexagonal, 7/16 inch thick-----	21
	<u>1/2-14 Thread</u>	
	<u>.500 inch diameter, 14 threads per inch; tap No. V211</u>	
22539 R	Plug Screw, tapered, 17/32 inch long-----	6
	<u>1/2-13 Thread</u>	
	<u>.500 inch diameter, 13 threads per inch; tap No. V136, tap drill 27/64 (.4218 inch diameter)</u>	
22650 CH-10	Set Screw, headless, socket type, cup point, 5/8 inch long-----	7

NOTE: A Dash (-) in the "Page No." column denotes the absence of an illustration.

CLASSIFIED LIST OF PARTS

<u>Part No.</u>	<u>Description</u>	<u>Page No.</u>
<u>1/2-13 Thread (continued)</u>		
22620 R-56	Set Screw, headless, cup point, 7/8 inch long -----	6
22620 R-80	Set Screw, headless, cup point, 1 1/4 inches long-----	6
21845 D	Stud, headless, completely threaded, 1 1/2 inches long -----	6
22619 R-32	Cap Screw, fillister head, 2 1/4 inches long -----	12
22821	Screw, hexagonal head, 1 3/4 inches long-----	14
22607 A	Cap Screw, hexagonal head, 1 inch long -----	15
22608 A	Cap Screw, hexagonal head, 1 1/4 inches long-----	15
22609 A	Cap Screw, hexagonal head, 1 1/2 inches long-----	15
22609 C	Cap Screw, hexagonal head, 1 1/2 inches long, with slot in threaded portion-----	14
22610 A	Cap Screw, hexagonal head, 1 3/4 inches long-----	15
22827	Cap Screw, hexagonal head, 2 1/4 inches long-----	(-)
22611 A	Cap Screw, hexagonal head, 2 1/2 inches long-----	15
22612 A	Cap Screw, hexagonal head, 3 inches long -----	15
22640 R-224	Cap Screw, hexagonal head, 3 1/2 inches long-----	14
22632 R-48	Set Screw, square head, cup point, 3/4 inch long -----	15
22632 A	Set Screw, square head, cup point, 1 inch long -----	15
22633 C	Set Screw, square head, 1 1/2 inches long -----	15
22633 B	Set Screw, square head, cup point, 2 1/2 inches long -----	15
22632 R-224	Set Screw, square head, cup point, 3 1/2 inches long -----	15
22817	Shoulder Screw, hexagonal head, 1 11/16 inches long, with .562 inch diameter shoulder 11/16 inch long -----	15
21818 B	Nut, hexagonal, 1/2 inch thick-----	21
<u>1/2-12 Thread</u>		
<u>.500 inch diameter, 12 threads per inch</u>		
22610	Cap Screw, hexagonal head, 1 3/4 inches long-----	14
22612	Cap Screw, hexagonal head, 3 inches long -----	(-)
22632	Set Screw, square head, 1 inch long-----	15
22633	Set Screw, square head, 1 1/2 inches long --	15
22633 A	Set Screw, square head, 2 1/2 inches long -----	15
<u>.510-24 Thread</u>		
<u>.510 inch diameter, 24 threads per inch; tap No. V124, tap drill 15/32 (.4687 inch diameter)</u>		
22539 A	Screw, headless, 5/32 inch long -----	6
22539 H	Screw, headless, 5/32 inch long -----	6
33196	Screw, headless, 9/32 inch long, with hole through center-----	7
22883	Screw, fillister head, 7/32 inch long, brass -----	12
22883 A	Plug Screw, fillister head, 5/32 inch long -----	12
36297 D	Drain Plug Screw, fillister head, 21/32 inch long, 1/4 inch long threaded section-----	13
22883 H	Adapter Stud, 9/16 inch long, 5/16-18 internal thread, tap No. V134 -----	7
39153 G	Nut, hexagonal, 5/32 inch thick-----	21
12990	Nut, hexagonal, 9/32 inch thick-----	21
38251 H	Nut, circular, knurled, 7/16 inch thick-----	21
41375 V	Nut, circular, knurled, 15/32 inch thick-----	21
<u>.548-18 Thread</u>		
<u>.548 inch diameter, 18 threads per inch; tap No. V125, tap drill (.4921 inch diameter)</u>		
22539 E	Screw, headless, 5/32 inch long -----	6

NOTE: A Dash (-) in the "Page No." column denotes the absence of an illustration.

CLASSIFIED LIST OF PARTS

<u>Part No.</u>	<u>Description</u>	<u>Page No.</u>
<u>.548-18 Thread (continued)</u>		
35795 C	Nut, hexagonal, 3/8 inch thick-----	21
G20	Nut, circular, knurled, 1/2 inch thick-----	21
<u>.597-32 Thread</u>		
<u>.597 inch diameter, 32 threads per inch; tap No. V96, tap drill (.5661 inch diameter)</u>		
22539 G	Screw, headless, 5/32 inch long -----	6
22733 C	Screw, fillister head, 7/32 inch long -----	12
51257 H	Nut, hexagonal, 3/16 inch thick-----	21
<u>5/8-24 Thread</u>		
<u>.625 inch diameter, 24 threads per inch; tap No. V234, tap drill (.5906 inch diameter)</u>		
35733 G	Nut, hexagonal, 3/16 inch thick-----	21
<u>5/8-18 Thread</u>		
<u>.625 inch diameter, 18 threads per inch; tap No. V192, tap drill (.5709 inch diameter)</u>		
22895	Screw, hexagonal head, 1 1/8 inches long, with .404-16 internal thread, tap No. V122-----	7
<u>5/8-11 Thread</u>		
<u>.625 inch diameter, 11 threads per inch; tap No. V137, tap drill 17/32 (.5312 inch diameter)</u>		
22831	Screw, hexagonal head, 4 inches long -----	(-)
22613 V-64	Cap Screw, hexagonal head, 1 inch long -----	15
22613	Cap Screw, hexagonal head, 1 1/2 inches long-----	14
22614	Cap Screw, hexagonal head, 3 1/4 inches long-----	14
22613 V-256	Cap Screw, hexagonal head, 4 inches long -----	15
22634	Set Screw, square head, 4 inches long-----	15
11684 R	Nut, hexagonal, 3/8 inch thick-----	21
20143	Nut, hexagonal, 5/8 inch thick-----	20
<u>.671-36 Thread</u>		
<u>.671 inch diameter, 36 threads per inch; tap No. V126, tap drill (.6435 inch diameter)</u>		
22540	Screw, headless, 9/64 inch long, with .375 inch diameter hole through center-----	7
22539	Screw, headless, 5/32 inch long -----	6
22539 C	Screw, headless, 5/32 inch long -----	6
22539 F	Screw, headless, 5/32 inch long -----	6
K68569	Nipper Holding Bushing, fillister head, 3/16 inch long, with .182-40 thread tapped in head -----	7
35761 B	Nut, circular, knurled, 1/4 inch thick-----	21
<u>.680-24 Thread</u>		
<u>.680 inch diameter, 24 threads per inch; tap No. V29, tap drill 41/64 (.6406 inch diameter)</u>		
15476	Threaded Bushing, knurled head, 1 1/32 inches long -----	8
15477	Nut, circular, knurled, 1/4 inch thick-----	21

NOTE: A Dash (-) in the "Page No." column denotes the absence of an illustration.

CLASSIFIED LIST OF PARTS

<u>Part No.</u>	<u>Description</u>	<u>Page No.</u>
	<u>3/4-10 Thread</u> <u>.750 inch diameter, 10 threads per inch</u>	
22648 Z-160	Cap Screw, hexagonal head, 2 1/2 inches long-----	15
	<u>.804-24 Thread</u> <u>.804 inch diameter, 24 threads per inch; tap No. V264, tap drill No. 3/4 (.750 inch diameter)</u>	
22539 P	Plug Screw, headless, 27/64 inch long -----	6
	<u>.869-20 Thread</u> <u>.869 inch diameter, 20 threads per inch; tap No. V97, tap drill (.8199 inch diameter)</u>	
80644	Screw, headless, 1/4 inch long -----	6
22539 D	Screw, headless, 27/64 inch long -----	6
22539 N	Plug Screw, headless, 11/32 inch long -----	6
22733 D	Plug Screw, fillister head, 5/16 inch long -----	12
6091	Nut, hexagonal, 1/4 inch thick-----	21
	<u>.994-20 Thread</u> <u>.994 inch diameter, 20 threads per inch; tap No. V98, tap drill (.9449 inch diameter)</u>	
6091 A	Nut, circular, knurled, 15/64 inch thick-----	21
	<u>36V Thread</u> <u>Taper thread, 36 threads per inch; tap No. V127</u>	
39151	Nut, hexagonal, 11/64 inch thick-----	21
56	Nut, hexagonal, 7/32 inch thick-----	21
HA56	Nut, hexagonal, 9/32 inch thick-----	21

Aid Plant Layout! Boost Production!

PEDESTAL MOUNTED MACHINES

UNION SPECIAL'S pedestal mountings for sewing heads have offered a great many advantages to manufacturers ever since they were introduced as a revolutionary new type of mounting for feed-off-the-arm machines in Classes 35700 and 35800.

In the pedestal mounted type installation, the machine is completely isolated from the base and, where table boards are used, they are completely isolated from the pedestal and from the machine, which makes for smoother, quieter operation. In various cases, the motor may be mounted to the right or to the left under the machine handwheel. Mounting of the motor to the right provides maximum space under machine for the operator.

These new pedestals offer maximum flexibility, convenience, and adaptability to production lines, especially where variations in operation or garment styles are necessary from time to time. The foot treadles are adjustable laterally and the machine mounting bracket is adjustable vertically to suit the individual operator and to provide the most comfortable working position, thus reducing fatigue. The illustrations shown here are just a few of the many styles of machines that Union Special has to offer in the pedestal mounted type installation which manufacturers all over the world have found to be necessary equipment for increasing production.

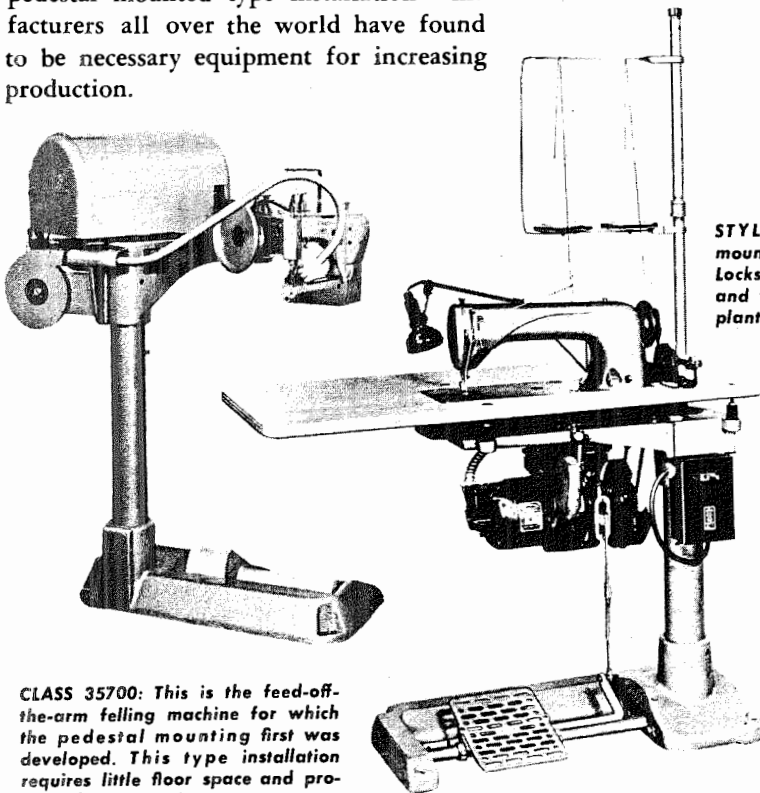

CLASS 35700: This is the feed-off-the-arm felling machine for which the pedestal mounting first was developed. This type installation requires little floor space and provides large working area.



STYLE 52900 BH: For simultaneously seaming and overedging the in-seams and outseams of corduroy pants and similar articles.

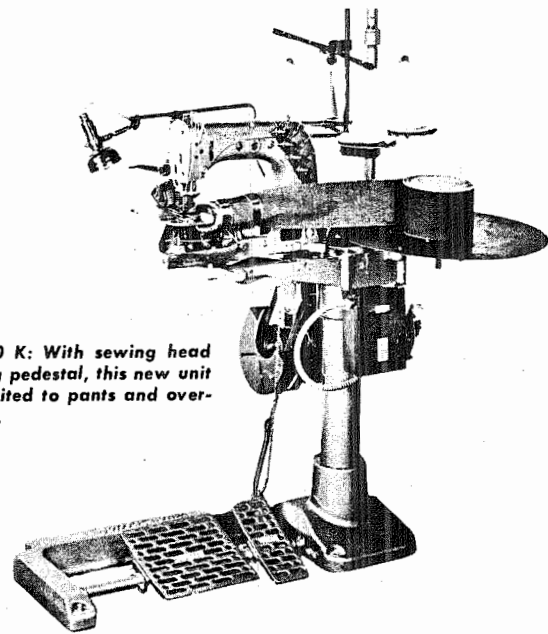

STYLE 54200 K: With sewing head overhanging pedestal, this new unit is ideally suited to pants and overall banding.

STYLE 61400 A: The pedestal mounted, plain feed, single needle lockstitch makes a most flexible and versatile unit for any sewing plant.

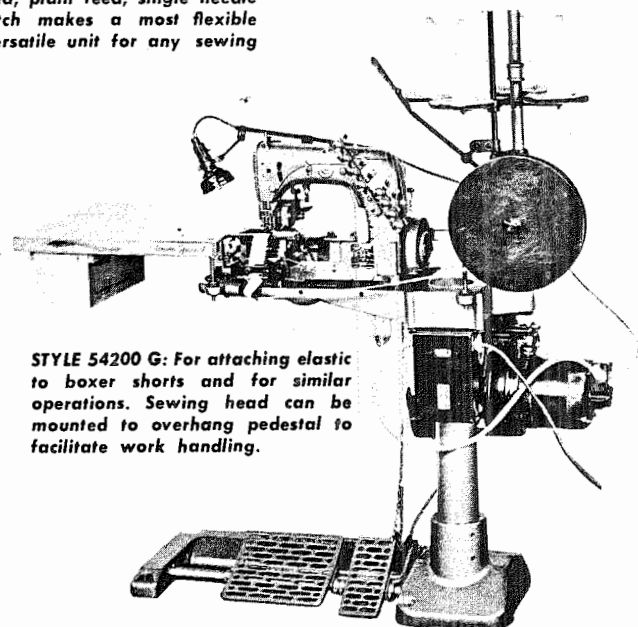

STYLE 54200 G: For attaching elastic to boxer shorts and for similar operations. Sewing head can be mounted to overhang pedestal to facilitate work handling.

**Sales Agents For Also Agent for (L) LEWIS and
UNION SPECIAL Machines; (C) COLUMBIA where marked.**

AFRICA

KENYA, NAIROBI—Pollack (E.A.) Ltd.—Also: Uganda and Tanganyika, Corner House, Harding Street (L & C)
MAURITIUS, PORT LOUIS—(Bag Closing & Bag Making Machines) Hall, Geneva, Langlois, Ltd., 42 Sir William Newton St., P.O. Box 77.
MOROCCO, CASABLANCA—R. Geissmann & Fils, Rue du Soldat Sanchez. (L)
PUBLIC OF CONGO, ELIZABETHVILLE—Progress, B. P. 2166 (sub-agent Berzack Bros. Ltd., Johannesburg, Union of South Africa.) (L)
SOUTHERN RHODESIA, FEDERATION OF RHODESIA & NYASALAND, BULAWAYO—(Textile Machines) Berzack Bros. (Rhodesia), 16-14th Ave. (L)
SALISBURY—(Textile Machines) Berzack Bros. (Salisbury) Pvt. Ltd., 102 Sinna St. (L)—(Bag Closing Machines) South African Scale Co., Pty., Ltd., Forbes & Angwa Sts.
SUDAN, KHARTOUM—Franco Pinto (Sudan) Ltd., P.O. Box 305.
TUNISIA, TUNIS—Comptoir Industriel & Menager C.I.M. 8 Rue du 18 Janvier 1952. (L)
UNION OF SOUTH AFRICA, JOHANNESBURG—(Textile Machines) Berzack Bros. Ltd., Berbro House, 135/7 Pritchard St. Branches at CAPE TOWN—78 Darling St.; DURBAN—72-74 Commercial Road; PORT ELIZABETH—58 Queen St. (L)
JOHANNESBURG—(Bag Closing Machines) South African Scale Co., Pty., Ltd., 32 Van Brandis St. Branches at: BLOMFONTEIN—53 Zaïstran St.; CAPE TOWN—Wales & Bree Sts.; DURBAN—22 Alwani St.; EAST LONDON—38 Argyle St.; PORT ELIZABETH—Box 611. Also at PIETERMARITZBURG, PRETORIA, VEREENIGING and WORCESTER.

AUSTRALIA

Sole Distributor—Capron, Carter (Pty.) Ltd. (L)
NEW SOUTH WALES, SYDNEY—86 Liverpool St.
QUEENSLAND, BRISBANE—454 Brunswick St., Valley, N. I.
SOUTH AUSTRALIA, ADELAIDE—(Sub-agents) Topp & Farmer, Ltd., 177 Hindley St.
TASMANIA, HOBART—(Sub-agents) Reliance Trading Co., 105 MacQuarie St.
VICTORIA, MELBOURNE—78 A'Beckett St.
WEST AUSTRALIA, PERTH—(Sub-agents) Thomsons, Ltd., 789 Hay St.

ASIA

CAMBODIA, PHOM-PENH—Denis Freres, P.O. Box 48. (C & L)
HONGKONG—G. R. Coleman Co. (Hongkong) Ltd., Room 308, Bank of Canton Bldg., 6 Des Voeux St., Central. (L & C)
INDIA, CALCUTTA—Don, Watson & Co., (Pvt.) Ltd., 19 British Indian St. (L)
JAPAN, OSAKA—Kondo Sewing Machine Co., 153 Umegae-cho, Kita-ku. (L)
KOREA, SEOUL—Ueberssee-Handel A.G., Rm. 604, Bando Bldg., 180 1-ka Ulchiro; Chung-Ku, Int. P.O. Box 1268. (L)
LAOS, VIENTIANE—Denis Freres, P.O. Box 133. (C & L)
PAKISTAN, KARACHI—2—Universal Trading Corp., 29 Zeenat Monsion, McLeod Road. (Textiles Machines Only) (Bag Closing and Bag Making Machines)—Thomas C. Keay, Ltd., 15 Baltic Street, Dundee, Scotland.
TAIWAN, TAIPEI—G. R. Coleman Co. (Hongkong) Ltd., 16 Nan Yang St. (L & C)
THAILAND, BANGKOK—Yip In Tsoi & Co., Ltd., P.O. Box 23. (Bag Making & Bag Closing Machines)
VIETNAM, SAIGON—Societe des Riz d'Indochine, Denis Freres, P.O. Box 444, 4 Rue Tu Da. (C & L)

BRITISH WEST INDIES

Union Special International, Inc.

JAMAICA, KINGSTON—Morris E. Parkin, 102 King St. (L)
BAHAMAS, NASSAU—H. L. Simon & Co., 2650 N.W. 5th Ave., Miami 37, Florida

EUROPE

AUSTRIA, VIENNA—Firma Nähschuster, Mariahilferstr. 51. (L)
BELGIUM, BRUSSELS—Union Special Machine Corporation of America, 23 Rue Philippe de Champagne, Henri Deloaf, Mgr. (C)
BRITISH ISLES—(Bag Closing and Bag Making Machines) Thomas C. Keay, Ltd., 15 Baltic St., Dundee, Scotland.
DENMARK, COPENHAGEN—Rathenborg Specialmaskiner for Sy-Industrien A/S, Nikolaj Plads 23. Offices at: AALBORG, HERNING, KOLDING, RISSKOV-AARHUS AND SILKEBORG. (L)
EIRE, DUBLIN—(Textile Machines) Machines, Ltd., 24 Upper Abbey St. (C) (Bag Closing and Bag Making Machines) Thomas C. Keay, Ltd., 15 Baltic St., Dundee, Scotland.
ENGLAND—(Textile Machines)—LEICESTER, Union Special Machine Co., Ltd., 25 Bede Street, Braunstone Gate, A. B. Fitzpatrick, Mgr. LEEDS, YORKSHIRE, C. Waters, 111 Alderton Heights, Moorstown, LONDON, E.C. 1, Union Special Machine Co., Ltd., 15-17 City Road, G. Johnson & Son (Sewing Machinery Ltd.) 53 Great Titchfield St. London W-1. MANCHESTER 1, S. A. Smith (Manchester) Ltd., 34 Oxford Road. PORTSMOUTH, Saunders Machine Co., (Portsmouth) Ltd., 110 Kingston Crescent. (Bag Closing and Bag Making Machines)—Thomas C. Keay, Ltd., 15 Baltic Street, Dundee, Scotland.
FINLAND, HELSINKI-LAUTTASAARI—Suomen. Koneliike O/Y, Vattuniemenkatu 13. Branches at TURKU, Yliopistonkatu 16. TAMPERE-Pienteilisuostalo (L & C)
FRANCE, PARIS—Cie. des Machines Union Special de France, 91 Ave. de la Republique, Georges Linotte, Mgr. GERMANY, STUTTGART—Union Special Maschinenfabrik, G.m.b.H., Schwabstr. 33. A. W. Krieger, Managing Director. BIELEFELD BRANCH, Bielefeld, Deimolder Str. 244. EBINGEN BRANCH, Ebingen/Württ., Gartensstr. 44. FRANKFURT BRANCH, Frankfurt/M.-Rödelheim, Reichsburgstr. 8. HAMBURG BRANCH, Hamburg-Eimsbüttel, Lappenbergsalle 4d. KÖLN BRANCH, Köln/Rh., Auf dem Hunnenrücken 25. MÜNCHEN BRANCH, Gmund/Paugensee, Bernöckersiedlung 7. (C) and Lewis button sewers. GREECE, ATHENS—Michel D. Dimoulis, 30 Petraki St. (L & C)
ITALY, MILANO—Giovanni Canti & Nipoti, Via Varese 18. (L)
THE NETHERLANDS, AMSTERDAM—N. V. Machinehandel C. & H. Verbeek, Klaveniersburgwal 77. Offices at: ENSCHEDE, GRONINGEN, ROTTERDAM, SITTARD. (L & C)
NORTHERN IRELAND, BELFAST—(Textile Machines) W. & J. Bogod & Co., Ltd., 6 Linenhall St. (C)
NORWAY, OSLO—Jac. Jacobsen A/S, Kr. Augustsgate 19 (Tullingsgaden); BERGEN—Bjornsonsgt 24. (C)
PORTUGAL, OPORTO—Rest & Janus, Succs. Lda., Rua Baraa de Forrester 914. (L)
SCOTLAND, DUNDEE—Thos. C. Keay, Ltd., 15 Baltic St. (Bag Closing and Bag Making Machines).
SCOTLAND, GLASGOW, S.E.—(Textile Machines) Allardice & Co., 9 Stevenson St.
SPAIN, BARCELONA—Rapida, S.A., Avino 9. (L)
SWEDEN, BORAS—Rud. Nystrom & Co., A/B, Lilla Brannergaten 6. Branches at OREBRO-Ostra Bangatan 18; MALMO, S. Forstodsgatan 16. Sub-Agent STOCKHOLM, A/B Farsberg & Kato, Tomtebgatan 38.
SWITZERLAND, ZURICH—M. L. Bourquin, Albsriederstrasse 226.

LATIN AMERICA

Union Special International, Inc.
ARGENTINA, BUENOS AIRES—Pamaco Costura, S.A., San Jose 350 (Union Special Machine Company). (L) (C)
BRAZIL, SAO PAULO—Pancostura, S.A.—Industria e Comercio—Rua Aurora 59A-71. Branches at PORTO ALEGRE—Rua Voluntarios da Patria 533; RECIFE—Rua Princesa Isabel 105; RIO DE JANEIRO—Rua Alexandre MacKenzie 117. (C & L)

CHILE, SANTIAGO—Lewenstein & Stewart, S.A.C., Calle Santo Domingo 1140. (L)
COLOMBIA, BOGOTA—Mecalzado, Ltda., Calle 13 #22-53. (L) Branches at BARRANQUILLA—Calle 37 #39-51. BUCARAMANGA—Calle 34 #17-45. CALI—Carrera 70 #14-33/35. MEDELLIN—Carrera 51, (Bolivar) #41-180. (L)
COSTA RICA, SAN JOSE—Champion Co., Ltda., Apartado 2742.
CUBA, HAVANA—(Textile & Bag Making Machines) Anilla Yarn & Supply Co., S. A., Factoria 70. (L) GUANABACOA, HAVANA—(Bag Closing Machines) Miguel A. Vilato, Edificio Martinez y Vilato, Via Blanca Rd., Apartado 644, Havana.
DOMINICAN REPUBLIC, CIUDAD TRUJILLO—Luis Dominguez, S. Calle 19 de Marzo #25. (L)
ECUADOR, GUAYAQUIL—Richard O. Custer, S.A., 9 de Octubre 211-213. Branch at QUITO—Carrera Benalcazar 659.
EL SALVADOR, SAN SALVADOR—Vairo Hermanos, Colonia Vairo. (L)
GUATEMALA, GUATEMALA—Compania Argo-Comercial, S.A., 8a Avenida Sur #10-43. (L & C)
MEXICO, MONTERREY, N.L.—Talleres Perez Zozaya, S.A. de C.V., Cuauhtemoc Norte 335. Branches at: GUADALAJARA, JAL.—Hidalgo 45 y 47; MEXICO, D.F.—Distribuidora Union Especial, S.A. de C.V., Ave. Pino Suarez 99-a (Apartado 12770); SAN LUIS POTOSI, S.L.P.—J. de las Reyes 80. (L)
NICARAGUA, MANAGUA—Casa Hentgen, 1a Ave. S.E. #407. (L)
PANAMA, PANAMA—Agencias Hagus, S.A. Ave. 7a Central 16-14.
PERU, LIMA—A. y F. Wiese, S.A., Esq. Nunez y Filipinas. (L)
PUERTO RICO, SAN JUAN—Abarca Warehouses Corp., P.O. Box 2352. (L)
SURINAM, PARAMARIBO—Kirpalani's, Ltd., 17-27 Maagden St. (L & C)
URUGUAY, MONTEVIDEO—Storer & Co., S.A., Uruguayua, Mercedes 1312. (L)
VENEZUELA, CARACAS—H. Blohm, S.A., Dr. Paul A. Chorro 29 (L)

NEAR EAST

CYPRUS, LARNACA—Choupourion Agencies, P.O. Box 194. (L)
EGYPT, CAIRO—A. Kavaldjian, 4 Midan el Cheikh Barakat. (L)
IRAN, TEHRAN—Sava Trading Corp., Ave. Bazarjomehri 655. (L & C)
IRAQ, BAGHDAD—Sons of O. O. Agopian, P. O. Box 121. (L & C)
ISRAEL, TEL AVIV—L. Taube, Ltd., 15 Liffenblom St. (L)
LEBANON, BEIRUT—Sons of O. O. Agopian, P.O. Box 1165. (L & C)
SYRIA, DAMAS—Elias Aractingi & Fils, Sidi Amoud. (L & C)
TURKEY, ISTANBUL—David ve Leon Varber ve Seriki, Hamdi Bey Cedici 36, 38, 40, Posta Kutusu 385. (L & C)

NEW ZEALAND

Sole Distributor—H. A. Tuck & Co., Ltd. (L)
AUCKLAND—171 Albert St. (L & C)
CHRISTCHURCH—(Sub-agent) Glendermid, Ltd., 78 Lichfield St. (L & C)
DUNEDIN—(Sub-agent) Glendermid, Ltd., 18 Dawling St. (L & C)
WELLINGTON—Ford Bldg., Courtenay Place. (L & C)

PACIFIC ISLANDS

HAWAII, HONOLULU 13—(Textile Machines) Territorial Sales Co., 540 Kamanui St. (L)
HAWAII, HONOLULU—(Bag Closing and Bag Making Machines) H. S. Gray Co., 759 Puuloa Rd.
PHILIPPINE ISLANDS, MANILA—(Textile Machines) Atkins, Kroll & Co., Inc., 124 Myers Bldg., Part Area. Branch at CEBU. (L) (Bag Closing and Bag Making Machines) Earnshaws Docks & Honolulu Iron Works Co., Tacoma & 2nd Sts., Part Area.

Additional Sales Agents for (L) LEWIS and (C) COLUMBIA Machines

AUSTRALIA, MELBOURNE—Michaelis, Hallenstein & Co., Pty., Ltd., 441 Lonsdale Street. (C)
AUSTRIA, VIENNA—Franz Karpert, Währingerstr. 141. (C)
BELGIUM, BRUSSELS—N. V. Machinehandel C. & H. Verbeek, 57A Blvd. du Jardin Botanique, Buyl Building. (L)
BRITISH ISLES—Eastman Machine Co., Ltd., 89 Beddington Lane, Croyden, Surrey, England. (L)—Showroom and Repair Shop: 15-17 City Road, London, E.C.1, England. LEEDS—4 Vernon St., Manchester-60-62 Corporation St.
CHILE, SANTIAGO—Roberto E. Gattlieb & CIA, Catedral 1159. (C)
CUBA, HAVANA—American Sewing Machine Co., Dragones 202. (C)
DENMARK, COPENHAGEN—Dimas, Det Internationale Industriskjold A/S, Grønnegade 10. (C)
EIRE, DUBLIN—W. Blythman (Sub-Agent of The Eastman Machine Co.), 224 Parnell Street. (L)
ENGLAND-CROYDON, SURREY—Eastman Machine Company, Ltd., 89 Beddington Lane. Branches at LEEDS—4 Vernon Street, MANCHESTER—60-62 Corporation Street (L)
ENGLAND, LONDON—W. & J. Bogod & Co., Ltd., 85 City Road, London, E. C. 1 (C)
FRANCE, PARIS—Societe G. Arnan & Cie., 36 Rue Debel-eyme. (L)
FRANCE, PARIS—Aspe-Dumont & Cie., 13 Rue de la Fontaine-Au-Roi. (C)
GERMANY, BIELEFELD—Dürkappwerke-Maschinen Gesellschaft m.b.h. (L) except button sewers (also branch offices of Dürkappwerke).
GERMANY, KREFELD—Herbert Janssen, Alte Linner Strasse 104. (C tie machines only)
INDIA, DELHI—Munshi Ram B.Sc., Above Keventers, Koshmere Gate. (L)

ISRAEL, TEL AVIV—Israel Sewing Machine Co., 22 Yehuda Halevy St. (C)
ITALY, MILANO—Mario Jeri, Via Morigi 13. (C)
MEXICO, MEXICO, D.F.—Casa Diaz de Maquinas de Cover, Apartado Postal 7259.
MOROCCO, CASABLANCA—Durkopp Coudrex, 25 Rue Baccaruma (C)
NORTHERN, IRELAND, Belfast—W. & J. Bogod & Co., Ltd., 6 Linenhall Street (C)
NORWAY, OSLO—H.A. Johansen A/S, Torvgatan 10. (L)
THE PHILIPPINES, MANILA—J. B. Y. Tanlimco Sons, Inc., 455-457 Junn Luna. (C)
PUERTO RICO, SANTURCE—Humberto A. Collada, Box 6777, Loixa Station (C)
SOUTHERN RHODESIA, FEDERATION OF RHODESIA & NYASALAND, BULAWAYO—African Sewing Machine Company, (Rhodesia) (Pvt.) Ltd.
SWEDEN, BORAS—Aktiebolaget A. G. Gustafson, Kungsgatan 28. (L) Branches at MALMO—Stora Kvarngatan 29, STOCKHOLM—Kungsgatan 18.
SWEDEN, BORAS—Husqvarna Industriskjold, Kungsgatan 34. (C)
SWITZERLAND, ZURICH—Fritz Zellweger & Co., Selnaustrasse 27. (L)
SWITZERLAND, ZURICH 4—A. Brunschweiler, Strassburgstrasse 15. (C)
UNION OF SOUTH AFRICA, JOHANNESBURG—African Sewing Machine Company (Pty.) Ltd., 85/87 Pritchard Street. Branches at: CAPE TOWN—110 Plein St.; DURBAN—16 Saville St. (C)
URUGUAY, MONTEVIDEO—Compania Recons S.A. (Intercomp Ltda.), Convencion 1374. (C)
WALES, CARDIFF—W & J Bogod & Co., Ltd., Newport Road. (C)

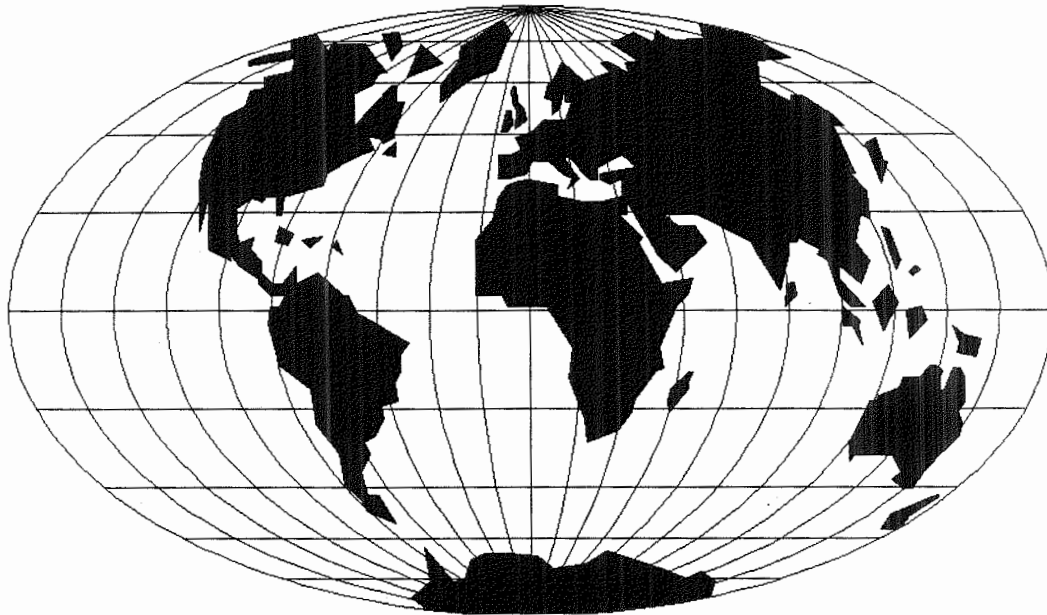

WORLDWIDE SALES AND SERVICE

Union Special Corporation maintains sales and service facilities throughout the world. These offices will aid you in the selection of the right sewing equipment for your particular operation. Union Special Corporation representatives and service technicians are factory trained and are able to serve your needs promptly and efficiently. Whatever your location, there is a qualified representative to serve you.

Corporate Office: One Union Special Plaza
Huntley, IL 60142
Phone: 847•669•5101
Fax: 847•669•1096

European Distribution Center: Union Special GmbH
Raiffeisenstrasse 3
D-71696 Möglingen, Germany
Tel: 49•07141•247•0
Fax: 49•7141•247•100

Brussels, Belgium
Charlotte, N.C.
El Paso, TX
Hong Kong, China
Huntley, IL
Leicester, England
Lille, France
Miami, FL
Milan, Italy
Möglingen, Germany
Montreal, Quebec
Osaka, Japan
Santa Fe Springs, CA

Other Representatives throughout
all parts of the world.



Union Special
INDUSTRIAL SEWING EQUIPMENT