

BES-961BC BES-1261BC

INSTRUCTION MANUAL

BROTHER
EMBROIDERY
SYSTEMS



Please read this manual before using the machine.
Please keep this manual within easy reach for quick reference.

NINE NEEDLE SIX HEAD ELECTRONIC EMBROIDERY MACHINE
TWELVE NEEDLE SIX HEAD ELECTRONIC EMBROIDERY MACHINE

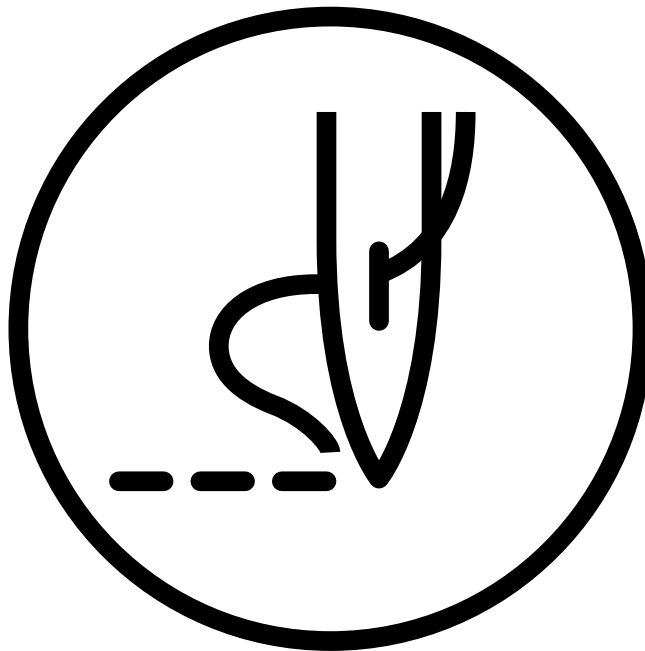

brother[®]

Precautions

- Unauthorized commercial or industrial use of trademarks or copyrighted materials (such as paintings, drawings, photos, logos, etc.) owned by other companies or persons is illegal. The use of such materials without the permission of their owners may result in criminal or civil liability.
- This manual may be subsequently modified without prior notice.
- Brother Industries, Ltd. shall assume no responsibility for any consequences of using this manual.

Thank you very much for buying a BROTHER sewing machine. Before using your new machine, please read the safety instructions below and the explanations given in the instruction manual.

With industrial sewing machines, it is normal to carry out work while positioned directly in front of moving parts such as the needle and thread take-up lever, and consequently there is always a danger of injury that can be caused by these parts. Follow the instructions from training personnel and instructors regarding safe and correct operation before operating the machine so that you will know how to use it correctly.

SAFETY INSTRUCTIONS

1 Safety indications and their meanings

This instruction manual and the indications and symbols that are used on the machine itself are provided in order to ensure safe operation of this machine and to prevent accidents and injury to yourself or other people. The meanings of these indications and symbols are given below.

Indications



DANGER

The instructions which follow this term indicate situations where failure to follow the instructions will almost certainly result in death or severe injury.



CAUTION

The instructions which follow this term indicate situations where failure to follow the instructions could cause injury when using the machine or physical damage to equipment and surroundings.

Symbols



..... This symbol () indicates something that you should be careful of. The picture inside the triangle indicates the nature of the caution that must be taken. (For example, the symbol at left means "beware of injury".)



..... This symbol () indicates something that you must not do.



..... This symbol () indicates something that you must do. The picture inside the circle indicates the nature of the thing that must be done. (For example, the symbol at left means "you must make the ground connection".)

2 Notes on safety

DANGER



Wait at least 5 minutes after turning off the power switch and disconnecting the power cord from the wall outlet before opening the face plate of the control box. Touching areas where high voltages are present can result in severe injury.

CAUTION

Installation



Machine installation should only be carried out by a qualified technician.



Contact your Brother dealer or a qualified electrician for any electrical work that may need to be done.



The sewing machine weighs more than 720 kg. The installation should be carried out by four or more people.



Do not connect the power cord until installation is complete, otherwise the machine may operate if the start switch is pressed by mistake, which could result in injury.



Be sure to connect the ground. If the ground connection is not secure, you run the risk of receiving a serious electric shock.



When securing the cords, do not bend the cords excessively or fasten them too hard with staples, otherwise there is the danger that fire or electric shocks could occur.



Be sure to wear protective goggles and gloves when handling the lubricating oil or grease, so that no oil or grease gets into your eyes or onto your skin, otherwise inflammation can result. Furthermore, do not drink the oil or grease under any circumstances, as they can cause vomiting and diarrhoea. Keep the oil out of the reach of children.



Avoid setting up the sewing machine near sources of strong electrical noise such as high-frequency welding equipment. If this precaution is not taken, incorrect machine operation may result.



The casters should be secured in such a way so that they cannot move.

Sewing



This sewing machine should only be used by operators who have received the necessary training in safe use beforehand.



The sewing machine should not be used for any applications other than sewing.



Turn off the power switch at the following times, otherwise the machine may operate if the start switch is pressed by mistake, which could result in injury.

- When threading the needle
- When replacing the bobbin and needle
- When not using the machine and when leaving the machine unattended



Do not get on the table. Table may be damaged.



Attach all safety devices before using the sewing machine. If the machine is used without these devices attached, injury may result.



Do not touch any of the moving parts or press any objects against the machine while sewing, as this may result in personal injury or damage to the machine.



Do not touch the pulse motor and sewing machine bed section during operation or for 30 minutes after operation. Otherwise burns may result.



If an error occurs in machine operation, or if abnormal noises or smells are noticed, immediately turn off the power switch. Then contact your nearest Brother dealer or a qualified technician.



If the machine develops a problem, contact your nearest Brother dealer or a qualified technician.

CAUTION

Cleaning



Turn off the power switch before starting any cleaning work, otherwise the machine may operate if the start switch is pressed by mistake, which could result in injury.



Be sure to wear protective goggles and gloves when handling the lubricating oil or grease, so that no oil or grease gets into your eyes or onto your skin, otherwise inflammation can result. Furthermore, do not drink the oil or grease under any circumstances, as they can cause vomiting and diarrhoea. Keep the oil out of the reach of children.

Maintenance and inspection



Maintenance and inspection of the sewing machine should only be carried out by a qualified technician.



Ask your Brother dealer or a qualified electrician to carry out any maintenance and inspection of the electrical system.



Turn off the power switch and disconnect the power cord from the wall outlet at the following times, otherwise the machine may operate if the treadle is depressed by mistake, which could result in injury.

- When carrying out inspection, adjustment and maintenance
- When replacing consumable parts such as the rotary hook and knife.



If the power switch needs to be left on when carrying out some adjustment, be extremely careful to observe all safety precautions.



Use only the proper replacement parts as specified by Brother.



If any safety devices have been removed, be absolutely sure to re-install them to their original positions and check that they operate correctly before using the machine.



Any problems in machine operation which result from unauthorized modifications to the machine will not be covered by the warranty.

3 Warning labels

* The following warning labels appear on the sewing machine.
Please follow the instructions on the labels at all times when using the machine. If the labels have been removed or are difficult to read, please contact your nearest Brother dealer.

1

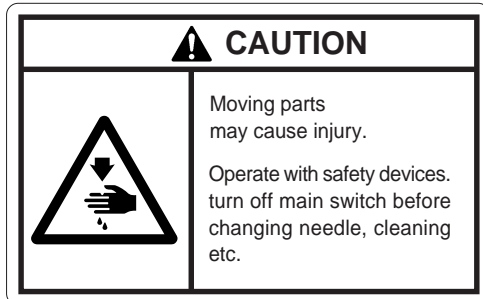

Safety devices: Finger guard, Belt cover, etc.

2

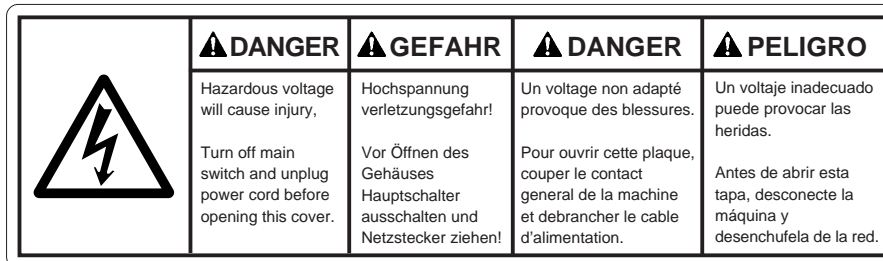

3

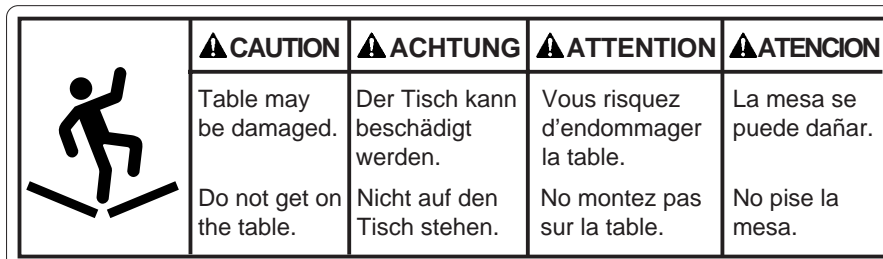

4



Never touch or push the thread take up during operation as it may result in injuries machine.

5



Never touch or push the needle bar during operation as it may result in injuries or damage to the sewing machine.

6

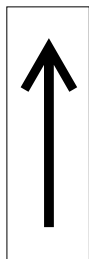

Direction of operation

7



Do not touch this part during activation or for 30 minutes after shut-off. Otherwise burns may result.

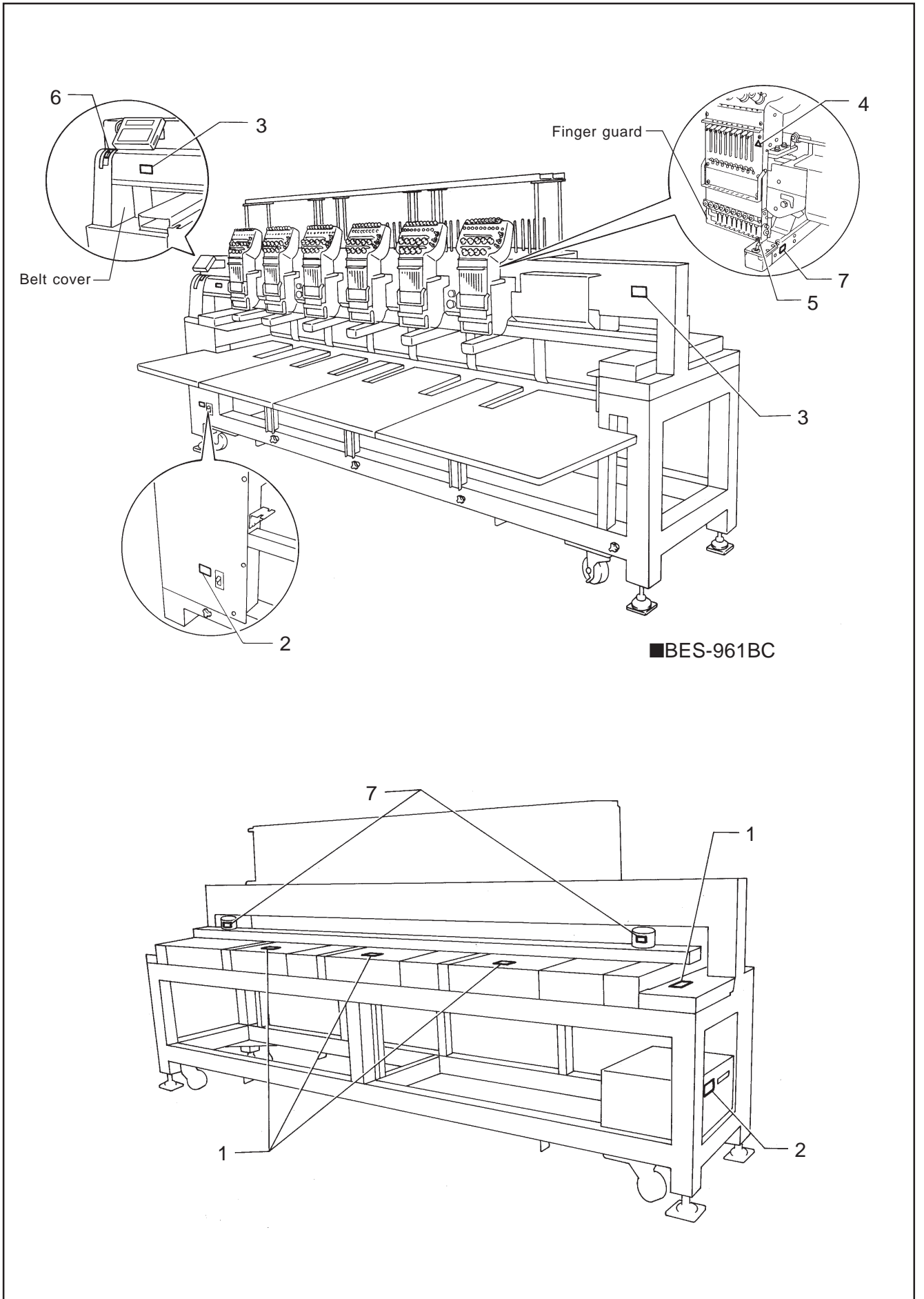

Before Starting Operation

Do not force open the shutter for direct contact with the magnetic area.

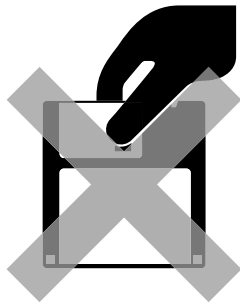

Do not bring disks near magnetic matters such as magnetic screwdriver.

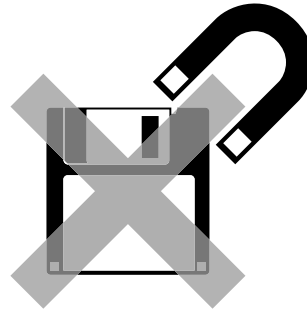

Do not store floppy disks in an extremely high or low ambient temperature.

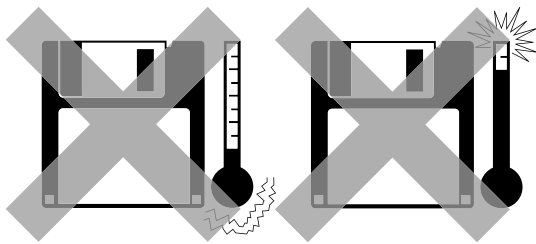

Do not use floppy disks under high humidity.



Do not use or store floppy disks in a dusty place.

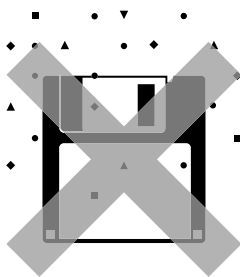

Do not store floppy disks under direct sunlight.

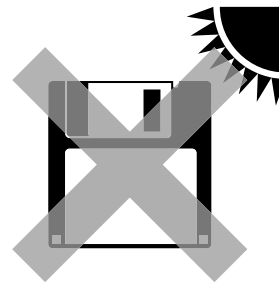

Do not bend the disk. Do not put things on the disk.

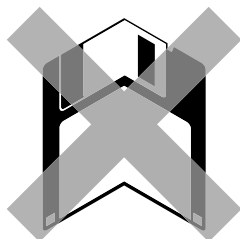

Avoid contact with solvent or drink.

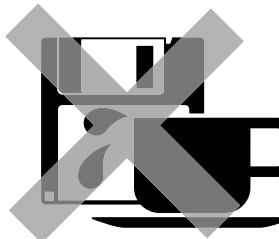

Do not remove the disk out of the drive during the access lamp is lit.

Protecting data in floppy disks

Write-protection is available for a floppy disk to prevent undesired data deletion. A write-protected disk is read-only. It is recommended to provide write-protection for disks which contain important data.

To do so, slide the write-protect notch to open the slot as shown below.

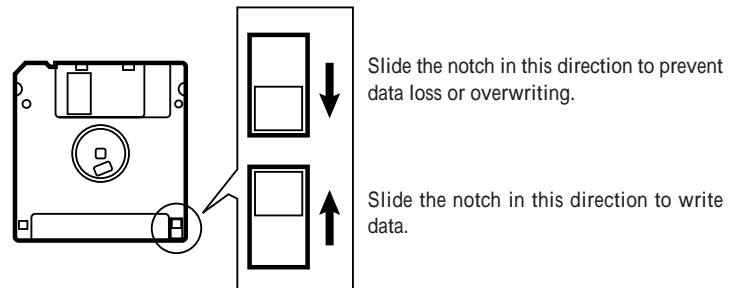

Procedure of Reading This Manual

Explanation of models

This manual explains two models:

- BES-961BC (9 needles)
- BES-1261BC (12 needles)

Explanation for individual model is provided by identifying the model name. Check the model before using the machine. The display is BES-961BC.

Configuration of this manual

This manual consists of the following chapters:

Chapter 1 Preparation of Embroidery Machine

This Chapter describes the specifications, installation and preparatory procedures of starting up the machine.

Chapter 2 Embroidering Procedures

Provides explanations on the operation panel and briefly reviews the flow of embroidering processes.

Chapter 3 Selection of Data and Embroidering

This Chapter describes procedures of reading sewing data and sewing.

Chapter 4 Editing of Embroidering Data

Explains how to edit the embroidery data.

Chapter 5 Setting

This Chapter describes procedures of setting the machine and working environment.

Chapter 6 Operation of Machine

Provides information on machine operation during embroidering.

Chapter 7 Maintenance

Describes appropriate maintenance of the machine.

Chapter 8 Standard Adjustment

Explains how to adjust the needles.

Chapter 9 List of Error Messages

Provides information on error codes and action to be taken.

Chapter 10 Troubleshooting

Provides troubleshooting for the machine.

Connection and Installation of Optional Equipment

Describes connections between the machine/computer and optional equipment available.

Screen Composition

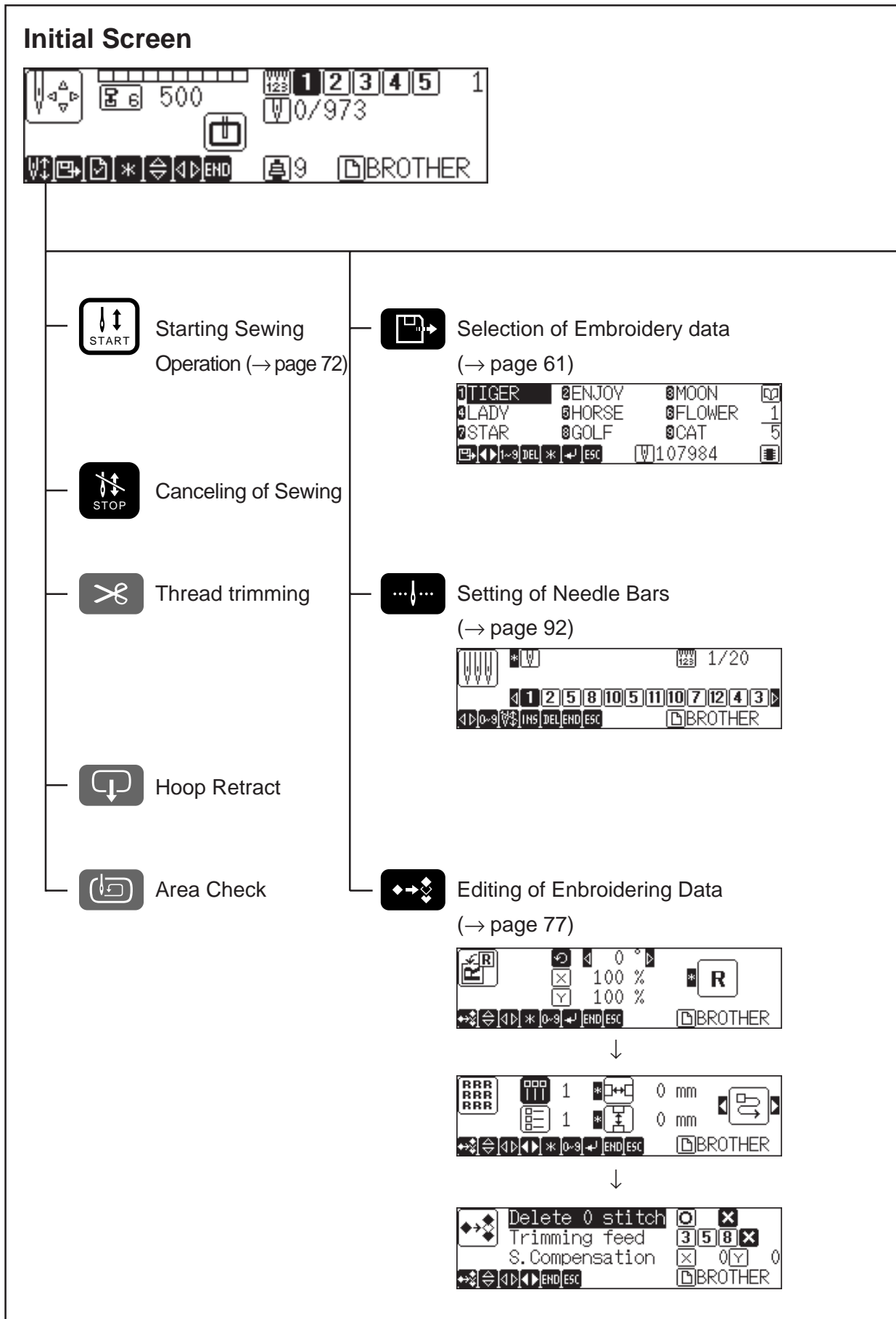



Setting of thread breakage sensor (→page 93)

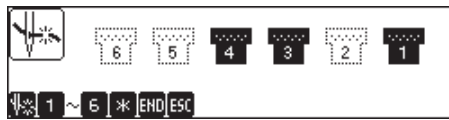

Setting of Machine (→page 96)

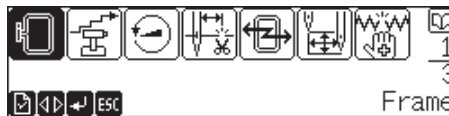

Contents

SAFTY INSTRUCTIONS.....	1
Before Starting Operation	6
Procedure of Reading This Manual	8
Screen Composition	10

Chapter 1 Preparation of Embroidery Machine

1. Specifications	18
2. Names of Machine Components	19
3. Installation	21
3-1. Transportation of Machine	21
3-2. Installation of Machine	23
3-3. Preparation of Needle Bar Case	24
3-4. Mounting of Table	26
3-5. Mounting of Cotton Stand	30
3-6. Lubrication to Needle Bar Case	32
3-7. Grounding	33
4. Preparation for Embroidering.....	34
4-1. Upper Threading	34
4-2. Replacement of Bobbin.....	37
4-3. Replacing and Selecting Needle	38
4-4. Attachment of Embroidery Hoop and Frame	39
4-5. Bed Retract	45
4-6. Adjustment of Thread Tension	47

Chapter 2 Embroidering Procedures

Functions of Operation Panel	50
Operation Panel	50
Switches at Machine Heads	53
Switches on Tension Plate	53
Flowchart of Preparation for Embroidering.....	55
Turn on the Machine Power	56
Retrieve the Embroidery Data	57
Start Embroidering	57

Chapter 3 Selection of Data and Embroidering

What Can the Machine Do?	60
Selection of Embroidery Data	60
Embroidering Operation	60
Selection of Data	61
Registration of Embroidery Data from Floppy Disk	61

Reading from Memory	64
Registration of Embroidery Data from BE-100	65
Deletion of Embroidery Data from Machine Memory	66
Modification of Embroidery Data Name	68
Sewing Operation	72
Before Starting Sewing	72
Starting Sewing Operation	72
Feedhold and Cancellation of Sewing	73
Step Forward and Step-Back	74
Step Forward/Step-Back Mode	74
Setting Amount or Timing of Step Forward/Step-Back	74
For Step Forward (Back)	75
Resuming Sewing	75

Chapter 4 Editing Embroidering Data

What Can the Machine Do?	78
Editing	78
Rotation	79
Enlargement and Reduction	80
Mirror	82
Repetition	84
Other Editing	86

Chapter 5 Settings

What Can the Machine Do?	90
Setting of Needle Bars	90
Setting of Thread Breackage Sensor	90
Setting of Machine	90
Setting of Environmenet	91
Display of Information	91
Hoop Retract point	91
Hoop Movement	91
Setting of Needle Bars	92
Thread Breackage Sensor	93
Setting of sensor validity/invalidity	93
Thread Breackage Sensitivity	93
Automatic Step-Back	94
Setting of Lower Thread Counter/Stitch Counter	95
Setting of Machine	96
Embroidery Hoop	96
Speed Range	97

Speed of Each Speed Range	98
Setting of Mending	99
Thread Trimming Length	101
Thread Withdrawal Feed Length	101
Inching	102
Sewing Area	103
Registration of Sewing Start Position	103
Hoop Retract Point	104
Hoop Automatic Retract	104
Movement to Registered Sewing Start Point	105
Setting of Environment	106
Return to Start Point	106
Speed Range	107
Power Voltage	107
Setting of RS-232C Communication Speed	108
Display Language	109
Alarm Sound	110
Boring	111
Display of Information	113
Pattern Information	113
Features of Machine	114
Information about Versions	115

Chapter 6 Operation of Machine

1. Operating Procedures	118
1-1. Power Source	118
1-2. Preparation for Embroidering	118
2. Machine Stop	119
2-1. Stopping of Machine	119
2-2. Resetting Emergency Stop	119
3. Measures against Thread Breakage	120
3-1. Remedies	120
3-2. Mending	122
4. Jog Embroidering	123
5. Hoop Feed Position	123
6. Area Check	124
6-1. External Tracing	124
6-2. Automatic Hoop Movement in Area	124
7. Jog Switches	125
7-1. Hoop Movement to Start Position	125
7-2. Inching Mode during Embroidering (Forcible Hoop Movement)	126
8. Detection of Zero Point	127

Chapter 7 Maintenance

1. Cleaning Rotary Hook	130
2. Oiling	131
2-1. Head	131
3. Greasing	133
3-1. Head	133
3-2. Feed Guide Section	137

Chapter 8 Standard Adjustment

1. Adjusting Needle Bar Height	140
2. Replacing (Attaching) Rotary Hook	144
3. Adjustment of Clearance Between Needle and Rotary Hook	145
4. Adjustment of Timing Between Needle and Rotary Hook	146
5. Adjustment of Presser Foot Height	147
6. Adjustment of Thread Trimmer	148
6-1. Attaching the Fixed Knife	148
6-2. Checking the Movable Knife Position	148
6-3. Adjusting the Belt Tention	150

Chapter 9 List of Error Message

Chapter 10 Troubleshooting

Mechanical Section	156
Electrical Section	158

Connection and Installation of Optional Equipment

Attaching Bobbin Winder	160
-------------------------------	-----



Chapter 1

Preparation of Embroidery Machine

1. Specifications

Embroidery machine used	9 needle embroidery machine head (six-head type)	12 needle embroidery machine head (six-head type)
Application	Pattern embroidery	
Sewing speed	Maximum 1000 spm	
Sewing area	450 (V) x 400 (H) mm (border frame area) 430 (V) x 300 (H) mm (tubular square hoop area) 85 (V) x 360 (H) mm (cap frame area) 450 (V) x 600 (H) mm (with bed retracted or with head control)	
Feed system	By timing belt and stepping motor drive	
Stitch length	0.1 ~ 12.7 mm (minimum pitch: 0.1 mm)	
Storage medium	3.5 2DD floppy disk (Tajima format) 3.5 2HD floppy disk (the equivalent to Tajima format) 3.5 2DD floppy disk (Barudan FDR/FMC format)	
Thread trimming	Automatic thread trimmer	
Needle thread breakage	Needle thread breakage detector	
Power supply	Single phase 200 V, 220 V, 230 V, 240 V, 1.7 kVA	
Weight	720 kg	720 kg
Dimensions	(Before assembly) 3650 (W) x 810 (L) x 1650 (H) mm (After setup) 3650 (W) x 1400 (L) x 1650 (H) mm (Distance between machine heads) 400 mm	
Options	Embroidery hoops in different sizes, Bobbin winder, Parts for boring	

2. Names of Machine Components

■ BES-961BC

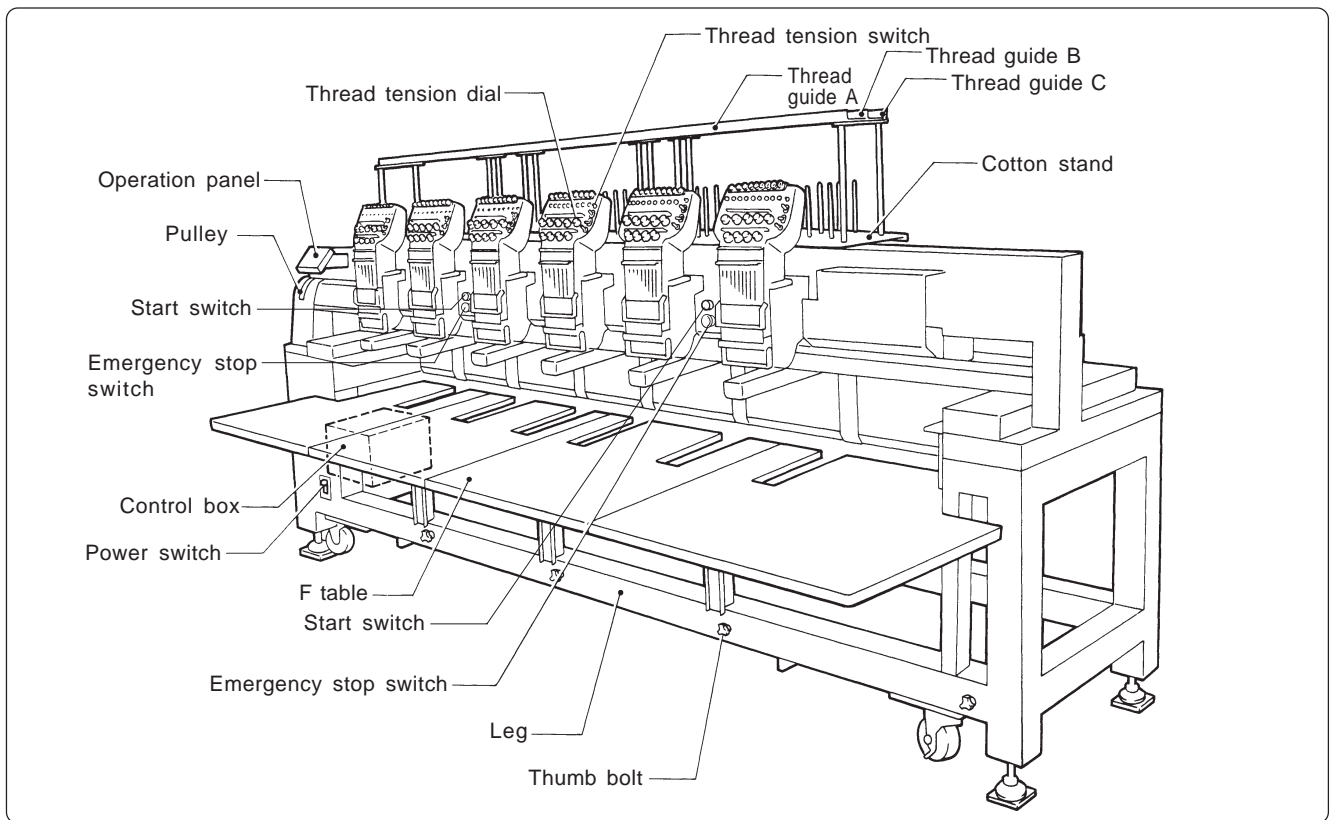

■ BES-1261BC

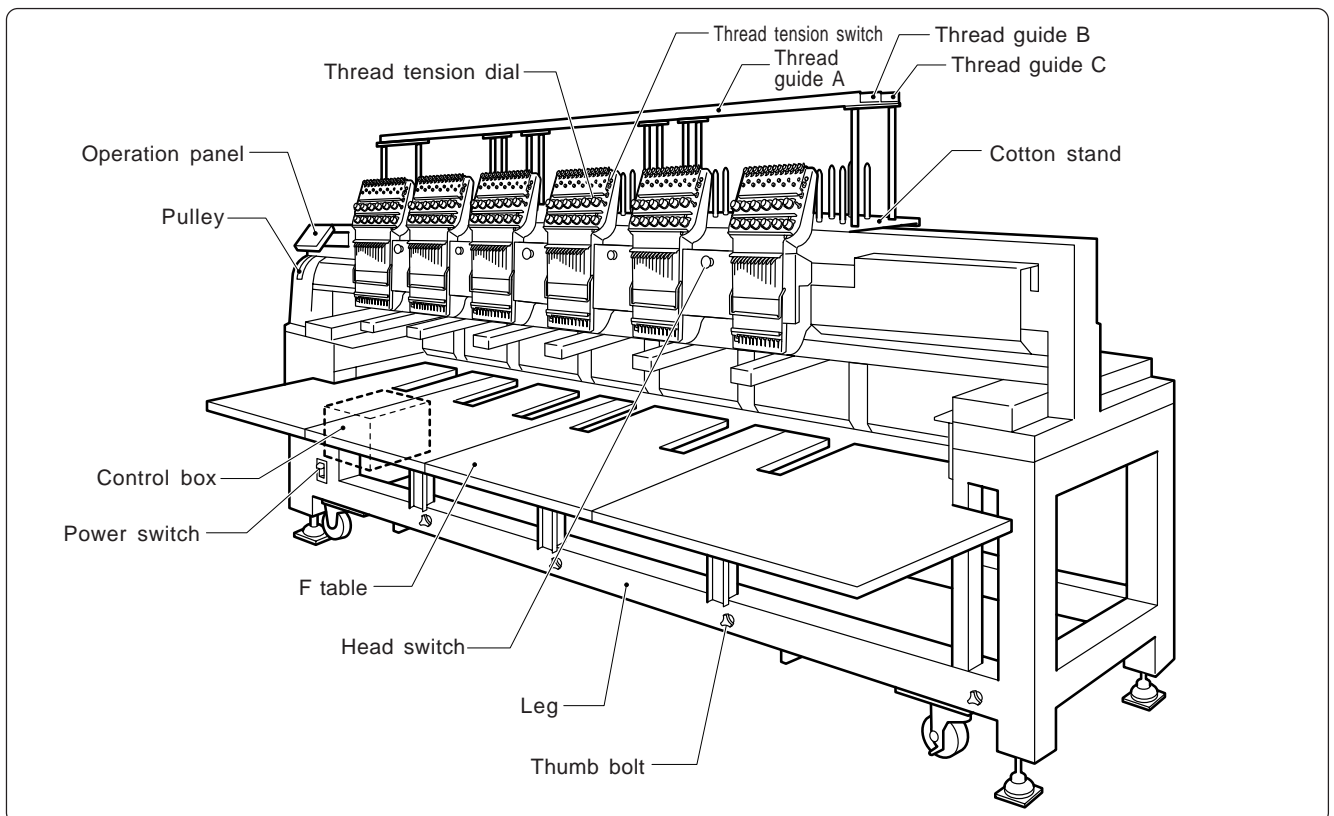

The machine heads are numbered 1 to 6 from the right front.

■ Accessories

	Standard Accessories	Optional Accessories
Embroidery hoop	<ul style="list-style-type: none"> • Tubular square hoop 30 x 43 (6) • Tubular round arm set R (6) • Tubular round arm set L (6) 	<ul style="list-style-type: none"> • Holder base 30 x 43 (6) <p>Other embroidery hoops in different sizes</p> <ul style="list-style-type: none"> • Sash frame assembly * Other Tajima embroidery hoops that can be used with BAS-412A and 416A • Cap frame (6) Cap frame drive assembly (6) Base frame set (12) Set frame base set (1)
Others	F table assembly	<ul style="list-style-type: none"> • Bobbin winder • Parts for boring

3. Installation

⚠ DANGER

- ⊘ Embroidery machines should be installed only by trained engineers.
- ⚠ Electric wiring should be laid by your distributor or electric experts.
- ⚠ A machine weighs more than 720 kg. Installation should be carried out by 4 or more workers.
- ⊘ Do not connect the power source until installation is completed. Doing so may start the machine unintentionally through an accidental activation of the START switch, resulting in bodily injuries.
- ⚠ Install a machine in a place away from a high-frequency welding machine or other machines that may generate a strong electric noise. Failure to do so may cause the embroidery machine to malfunction.
- ⚠ Establish grounding as designated. Improper grounding may result in an electric shock.

* After installation is completed, get the power supply from a dedicated outlet.

* When connecting multiple machines, exercise care not to exceed the capacity of the outlet.

3-1 Transportation of Machine

When relocating the machine, push the steel frame.

Note) Never push the cover or carriage.

■ When using a fork lift

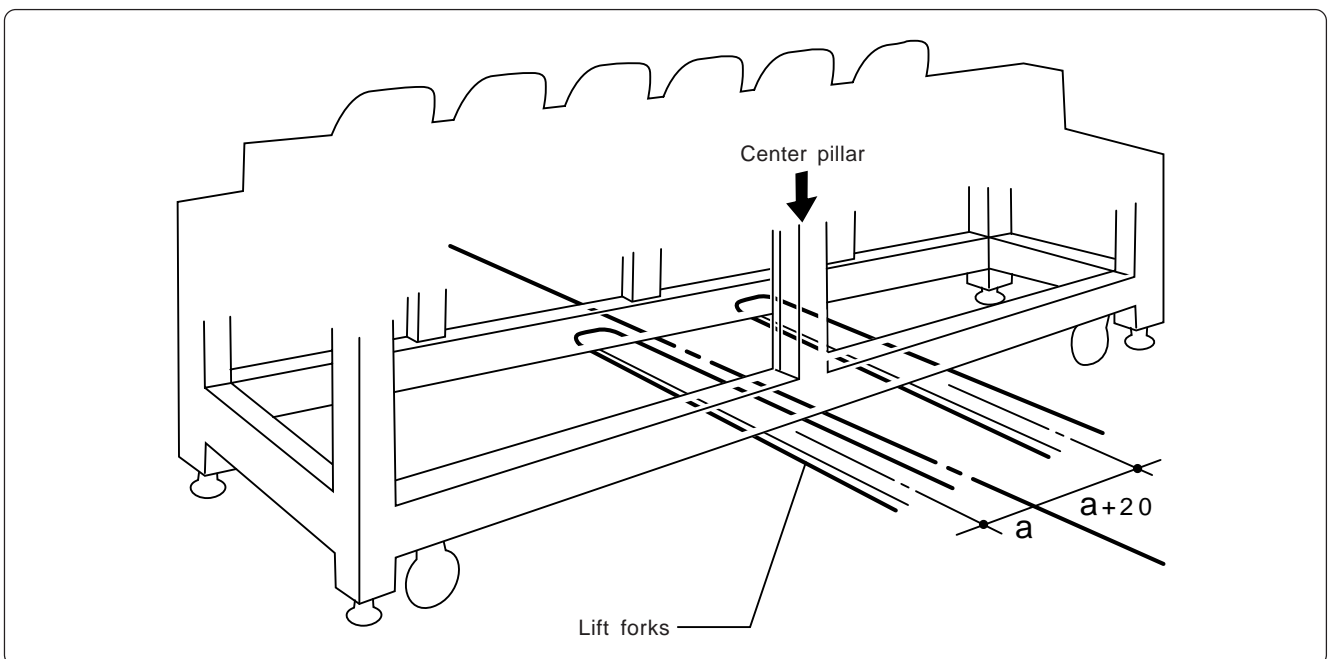

Open the forks of the lift approximately 10 cm to the right from the even position to the center pillar viewed from the rear of the machine, and pass them under the legs to lift the machine.

■ When using a crane

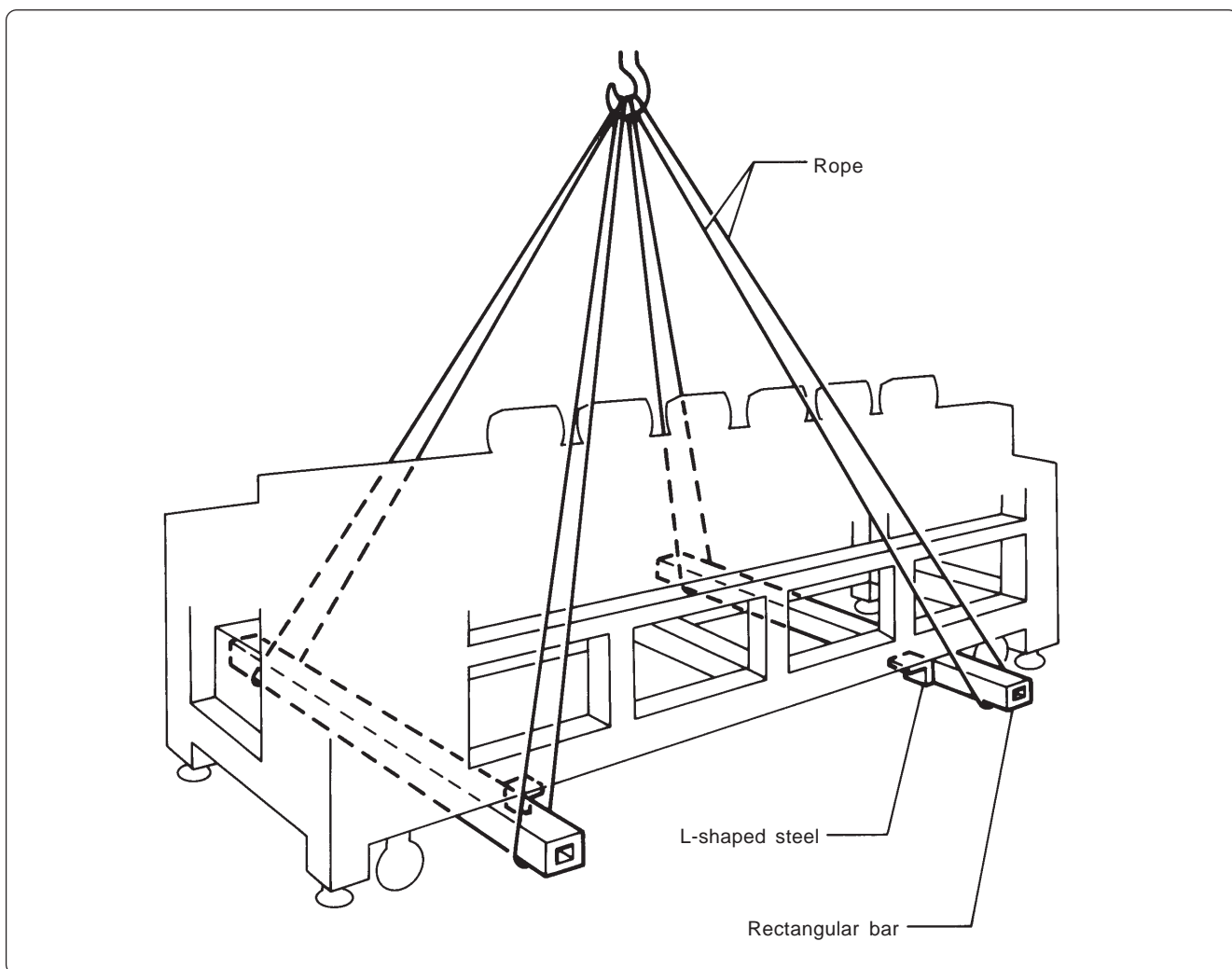

Place two rectangular bars on the four L-shaped steels on the bottom of the machine steel frame. Loop four ropes around the bars and lift the machine.

Note) When lifting the machine, make sure that the ropes do not contact the machine table or the tension plate.

3-2 Installation of Machine

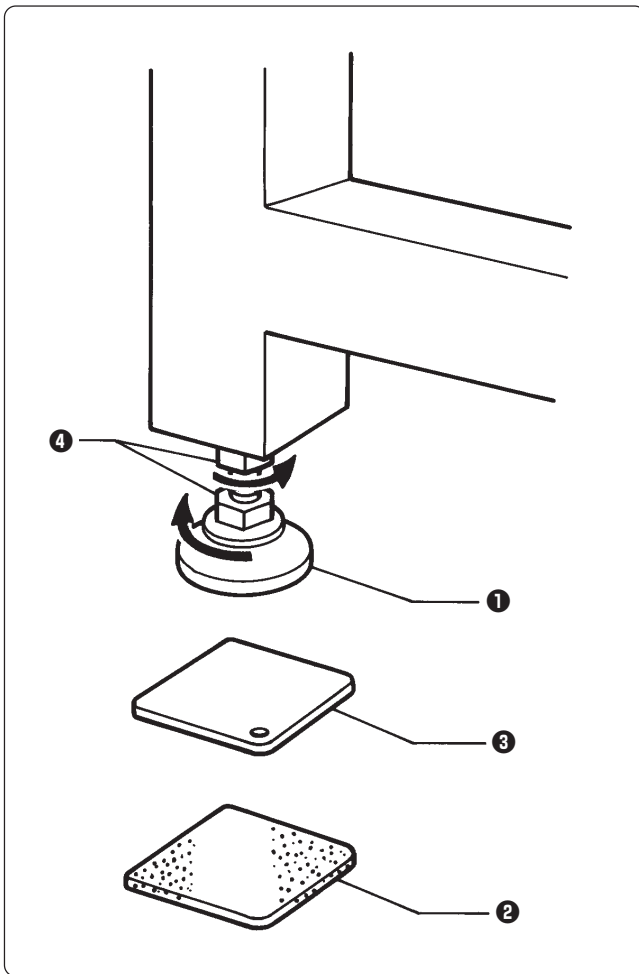

1. Place the attached cushion sheets **2** and leveling plates **3** under the four level adjusters **1**. The leveling plates **3** should be placed above the cushion sheets respectively.
2. Secure the four level adjusters **1** on the ground using the nuts **4** so that the machine will be stable.

Note) If the floor is not strong enough, the embroidery machine may be rocked during operation. In such a case, it is recommended that a secure base of concrete be placed below the embroidery machine.

3-3 Preparation of Needle Bar Case

■ BES-961BC

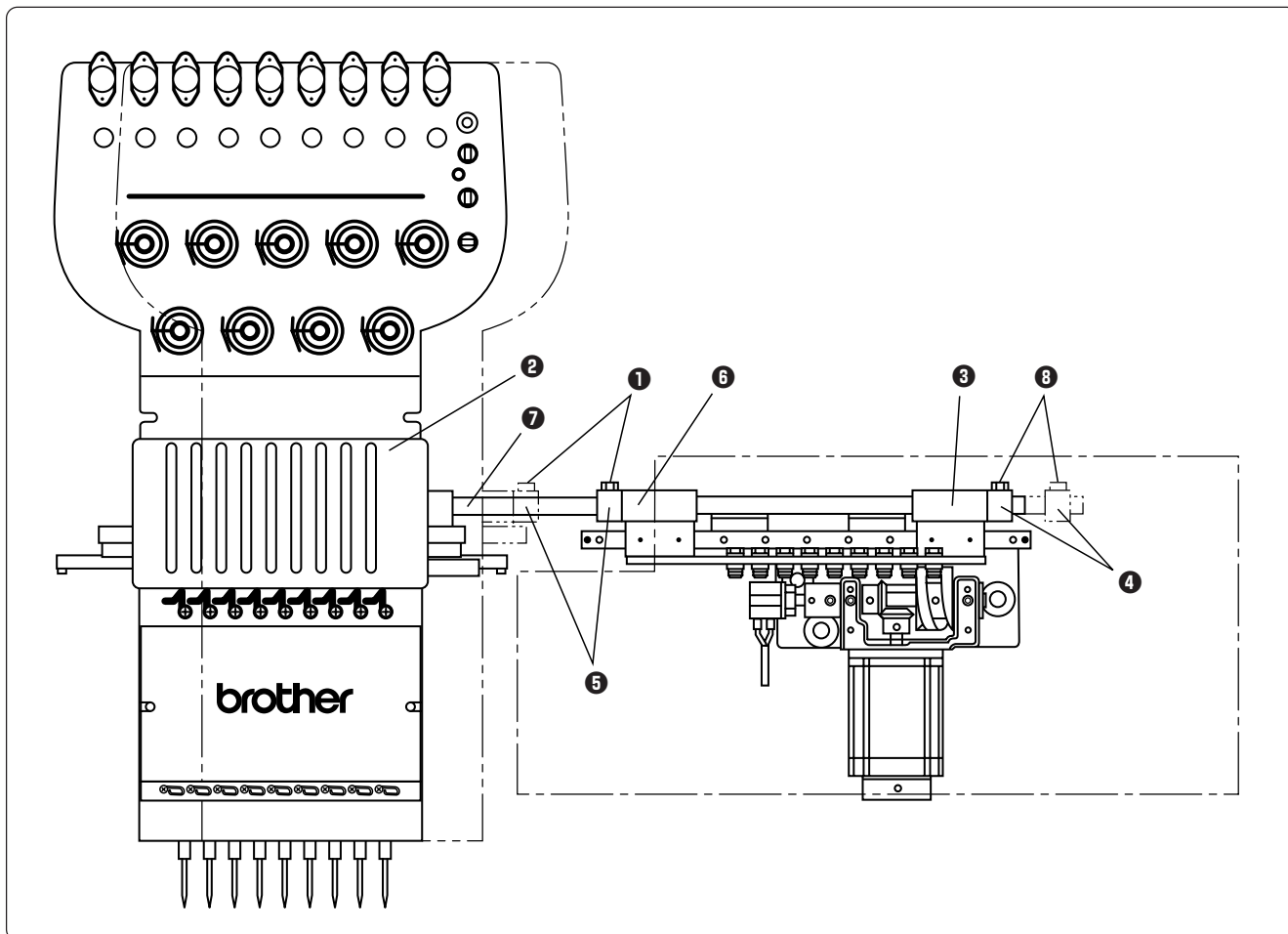

1. Loosen the bolt **1**, and move the needle case **2** to the left.
2. Press the change bracket collar **4** against the change case base **3** on the right, while pressing the change bracket collar **5** against the change case base **6** on the left, and tighten the bolt **1**. Check that needles at needle bar No.1 and 9 are inserted into the needle plate holes smoothly.

Note) • Check that the connecting shaft **7** does not have backlash in the horizontal direction.
 • If the bolt **8** of the change bracket collar on the right is loosened, it may be dislocated during adjustment of the needle bar case **2**. Do not loosen this bolt.

■ BES-1261BC

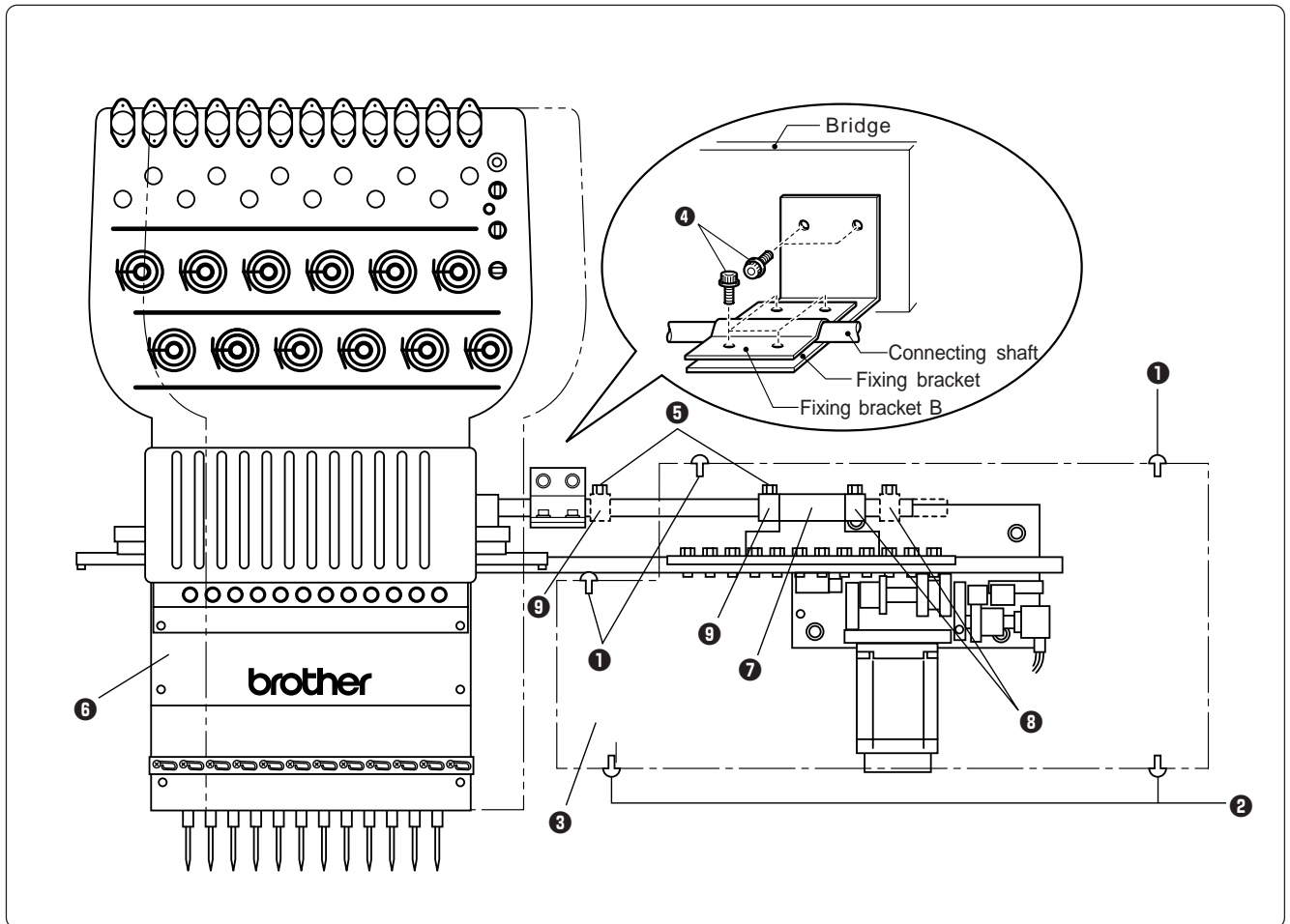

1. Remove 3 pieces of fixing screw ①, loosen 2 pieces of screw ② and remove the color change cover ③.
2. Remove the bolts ④ and detach the fixing bracket for transportation from the bridge and the connecting shaft.
3. Loosen the bolts ⑤ and move the needle bar case ⑥ left side.
4. Press the change bracket collar ⑧ against the change case base ⑦, while pressing the left side change bracket collar ⑨ against the change case base ⑦, and tighten the bolts ⑤. Check that needle bar No.1 and 12 are inserted into the needle plate holes smoothly.

(Notes) • Check that there is no play for the connecting shaft in the horizontal direction.

- If the bolt of the right side change bracket collar ⑧ is loosened, the change bracket collar ⑧ may be dislocated and adjusting position of the needle bar case ⑥ will be required. So don't loosen this bolt.

5. Attach the color change cover ③ by 3 pieces of fixing screw ① and 2 pieces of fixing screw ②.

3-4 Mounting of Table

■ Mounting of F table

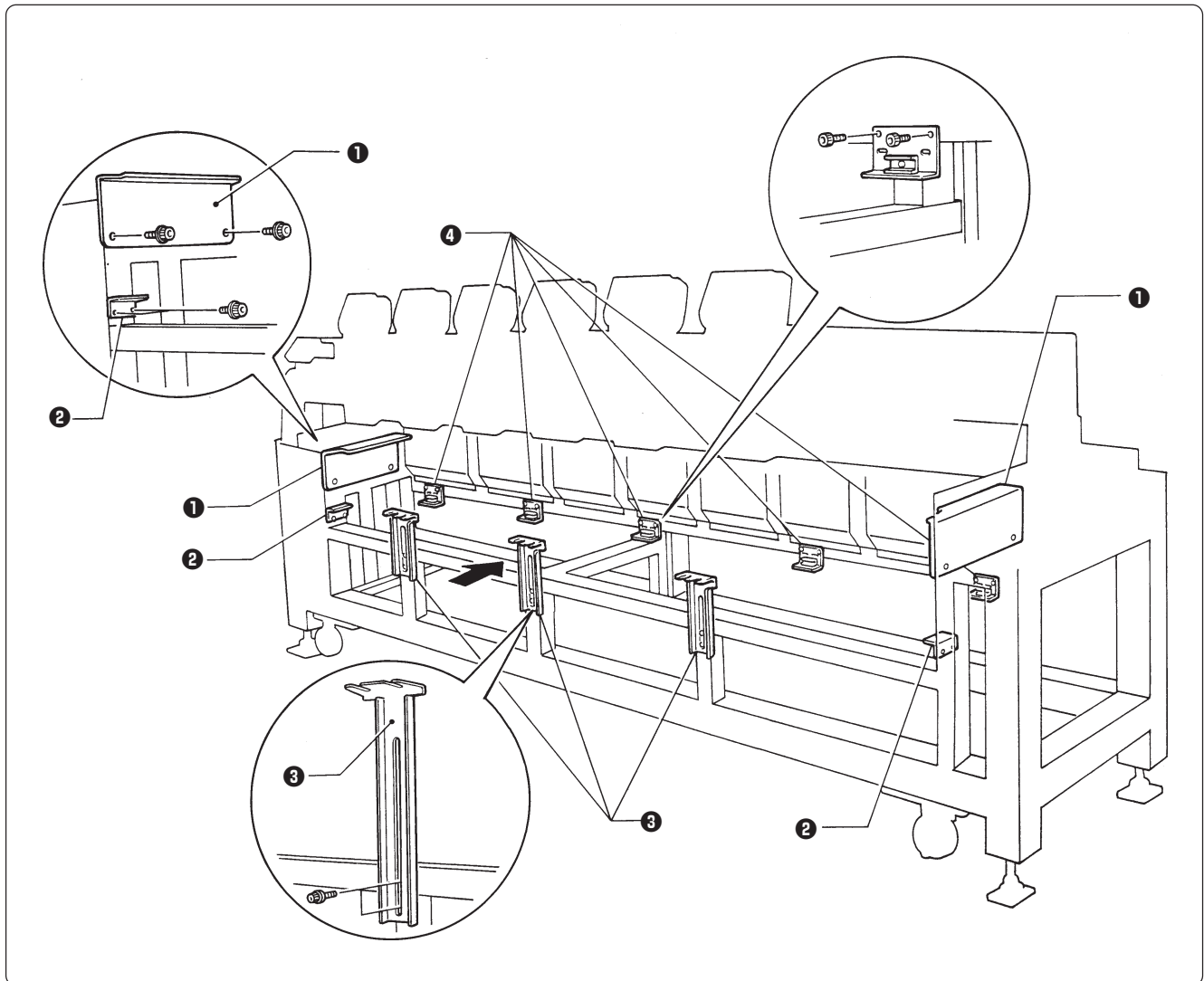

1. Tentatively mount the F table guides U **1** and L **2** on both sides of the legs using two bolts each.
2. Tentatively mount there F table supports F **3** on the leg front using two bolts each.
3. Tentatively mount five F table stoppers **4** on the rear legs using two bolts each.

Note) • The steps 1 and 3 are required only when the F table set is purchased separately from the machine.
 • The F table is a standard attachment.

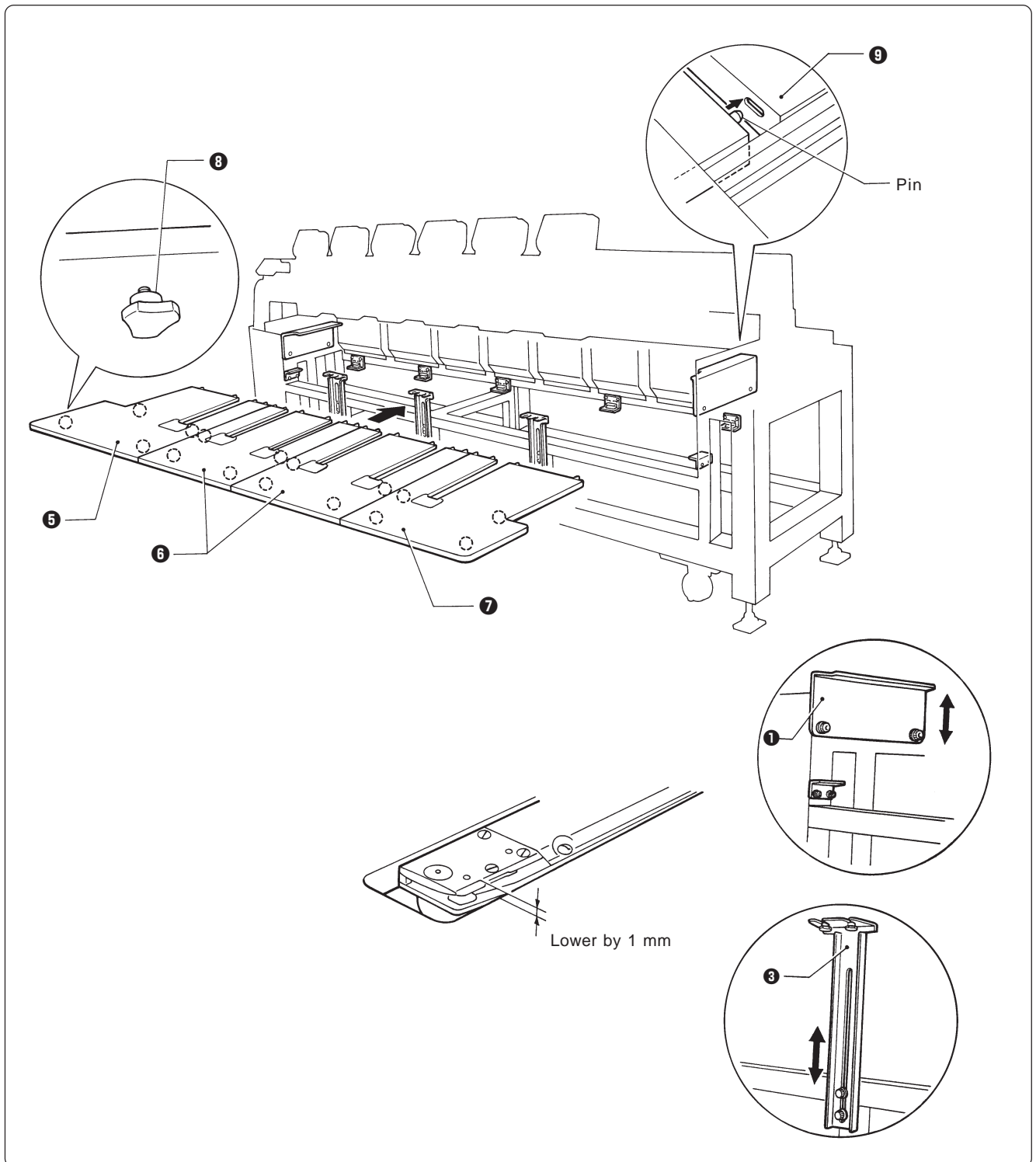

4. Mount four thumb bolts **8** each on the rear of F table R **5**, M (2 pcs.) **6**, and L **7**.
5. Mount five thumb bolts on the steel pipe below the front leg.
6. Insert the pins attached to the rear of the F table R **5**, M (2 pcs.) **6**, and L **7** into the cover **9** on the leg. Adjust the height of the F table guide U **1** and the F table support F **3** so that the table top surface will become 1 mm lower than the bed top surface. After adjustment is finished, tighten each bolt securely.

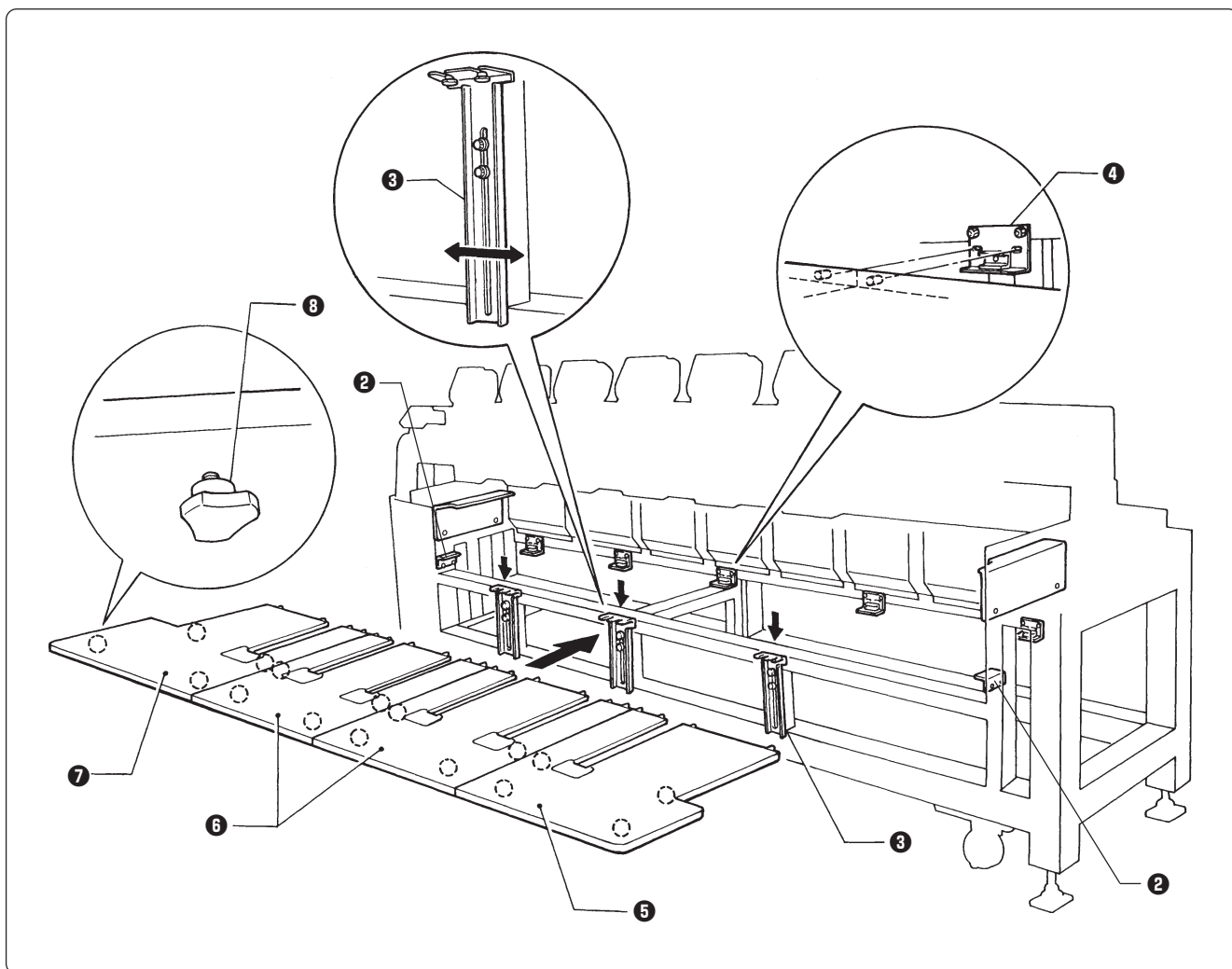

7. Dismount the F table R **5**, M (2 pcs.) **6**, and L **7** once, and lower the F table support F **3**. Then, place the F table R **5**, M (2 pcs.) **6**, and L **7** on the F table guide L **2** bending section. Fix the F table support F **3** at this height and insert the pins on the rear of the F table R **5**, M (2 pcs.) **6**, and L **7** into the holes of the F table stopper **4**.

Note) Fix the F table stopper and the F table guide L securely at this position.

8. Insert the F table R **5**, M (2 pcs.) **6**, and L **7** into the upper and lower positions respectively, then check if the table can be securely fixed by the thumb bolts **8**. If not, shift the F table support F **3** to the right and left for further adjustment.

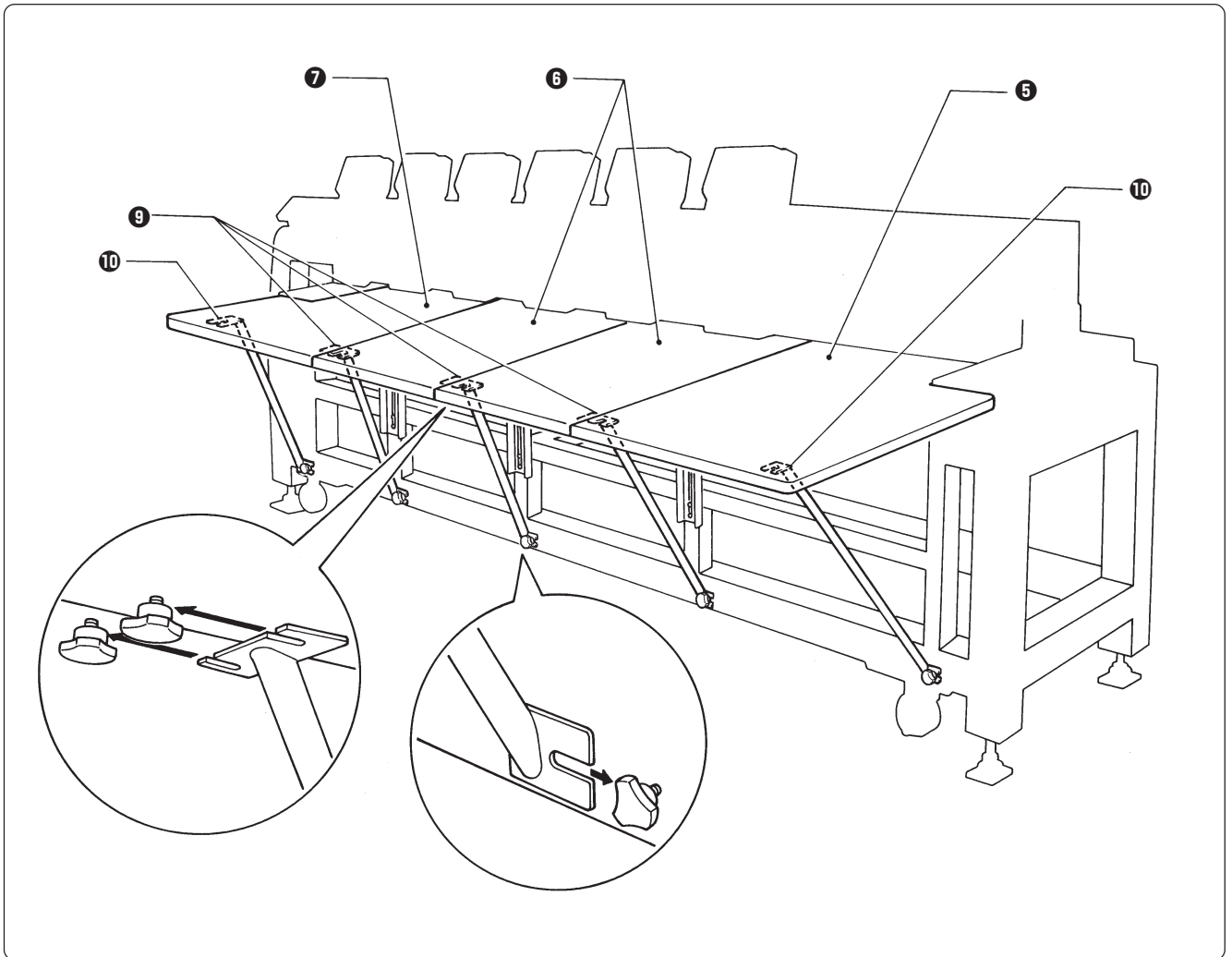

9. Fix the legs and the table using the F table stays A (3 pcs.) ⑨ and B (2 pcs.) ⑩ while the F table R ⑤, M (2 pcs.) ⑥, and L ⑦ are fixed at the upper position.

* Dismounting can be carried out in the reverse procedures.

Note) • Use two F table stays (B) with one notch at both ends of the F table R ⑤ and L ⑦.

- When mounting the F table stays A (3 pcs.) ⑨ and B (2 pcs.) ⑩, fit the F table stay notch into the table, then fix the notch to the legs using the thumb bolts.
Dismounting can be carried out in the reverse procedures.
- When the F table is at the lower position, the F table stays A and B need not be used.

3-5 Mounting of Cotton Stand

■ BES-961BC

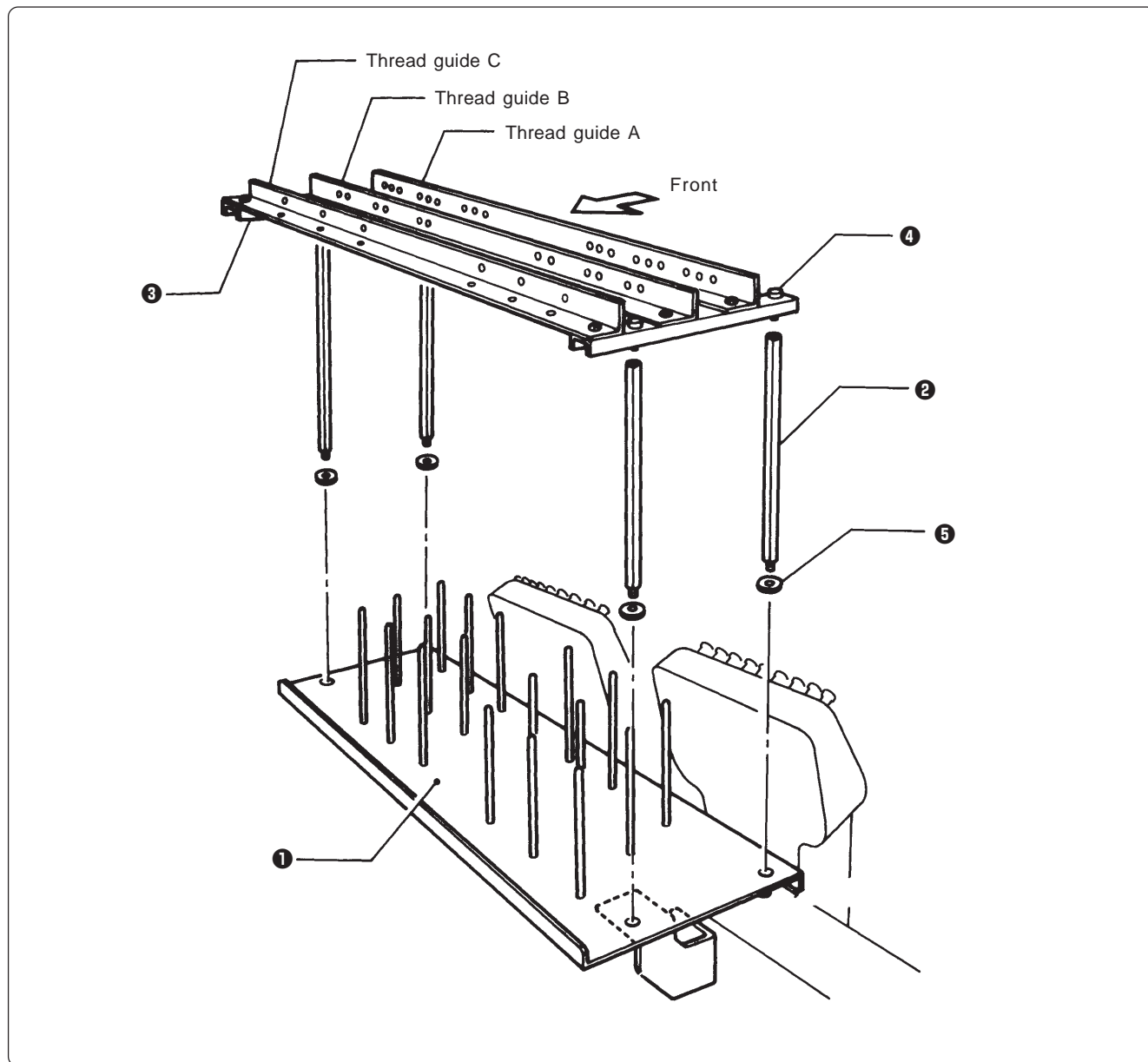

1. Attach four thread guide support bars ② to the cotton stand assembly ①, while fitting into the four holes.
2. Mount the thread guide assembly ③ on the thread guide support bars ② using the four screws ④.

Note) • When mounting, use one flat washer ⑤ below the thread guide support bar ②.
• Pay careful attention to the front and back directions of the thread guides (A, B, C).

■ BES-1261BC

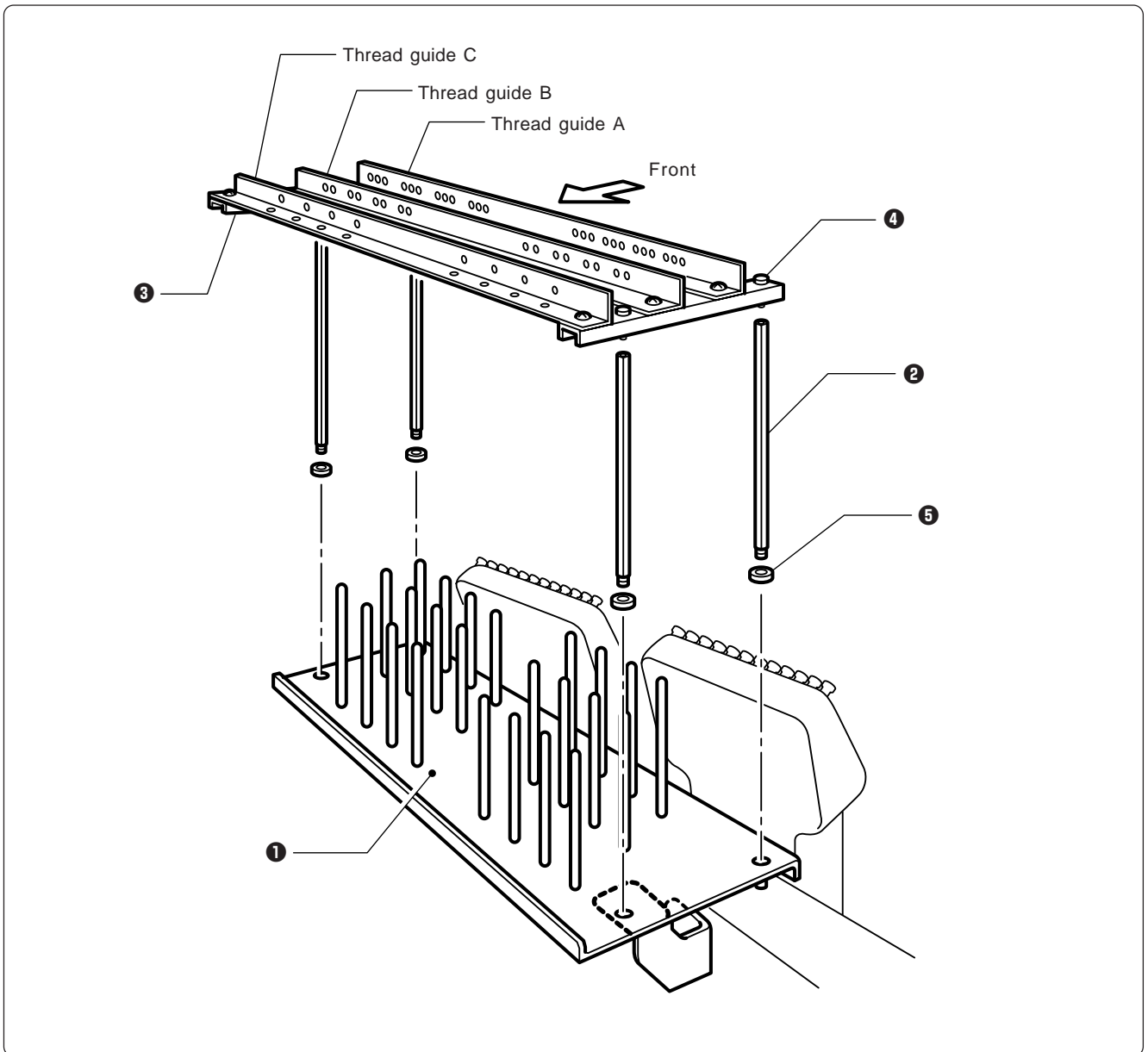

1. Attach four thread guide support bars ② to the cotton stand assembly ①, while fitting into the four holes.
2. Mount the thread guide assembly ③ on the thread guide support bars ② using the four screws ④.

Note) • When mounting, use one flat washer ⑤ below the thread guide support bar ②.
 • Pay careful attention to the front and back directions of the thread guides (A, B, C).

3-6 Lubrication to Needle Bar Case

Proper lubrication is necessary for keeping the machine head in good condition.

CAUTION



Turn off the power switch before starting any cleaning work, otherwise the machine may operate if the start switch is pressed by mistake, which could result in injury.

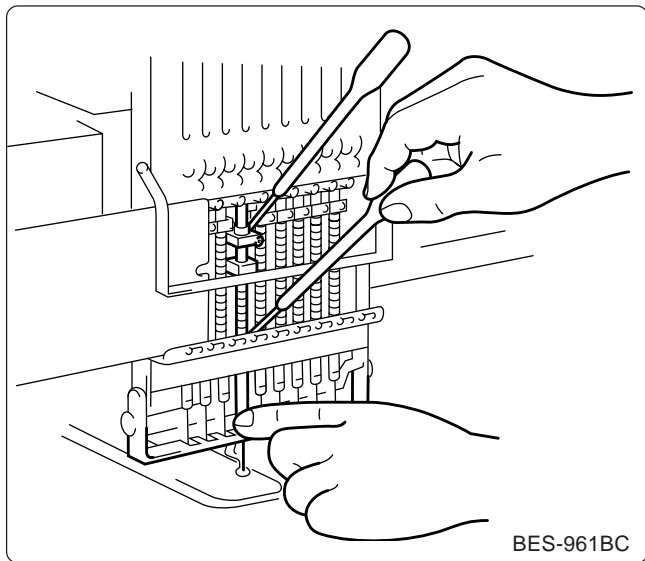

Before operating the machine for the first time after unpacking or after leaving the machine without operation for a long period of time, supply one or two drops of oil to two sections of the needle bar. (See the left figure.)

- Note)
- Use the Brother's specified embroidery machine oil (Nisseki Embroidery Lube No. 10 or the equivalent).
 - Supplying an excessive amount of oil will cause dripping onto the material.

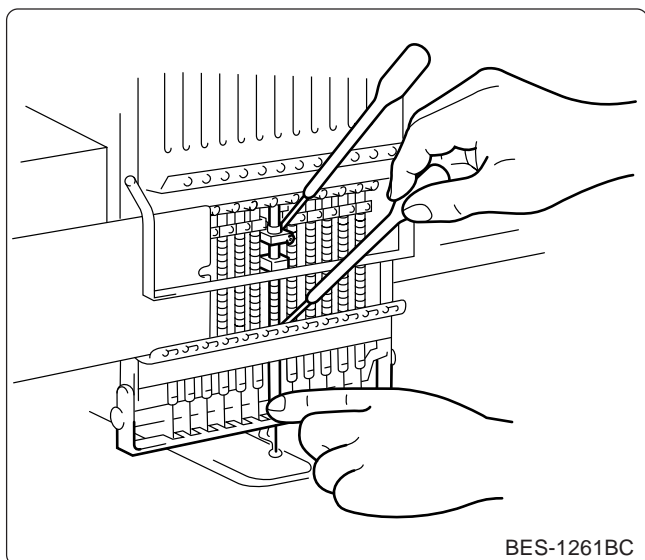

3-7 Grounding

- Note)
- When connecting the power supply, make sure to connect it to the grounding cable (with green and yellow stripes).
 - When plugging in the outlet, use a plug suited to the outlet.

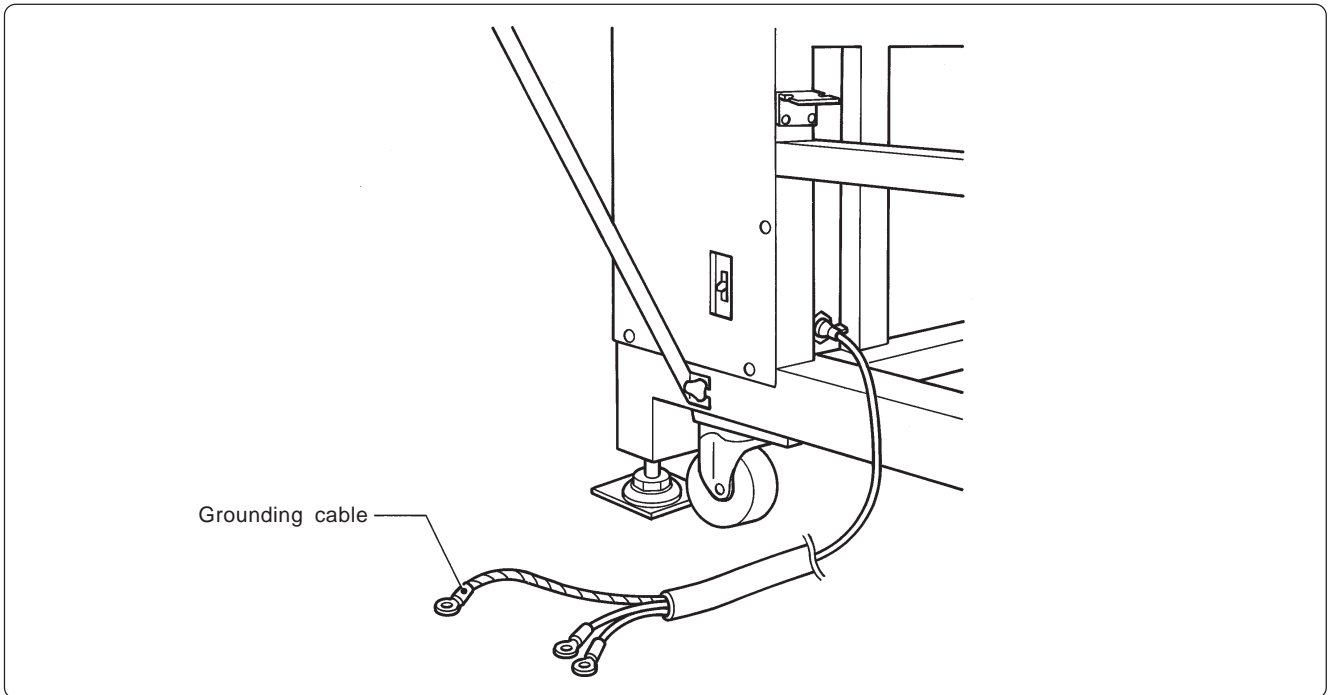

4. Preparation for Embroidering

⚠ CAUTION



Turn off the power switch before starting preparation.

Failure to do so may start the machine unintentionally through an accidental activation of the START switch, resulting in bodily injuries.

4-1 Upper Threading

■ BES-961BC

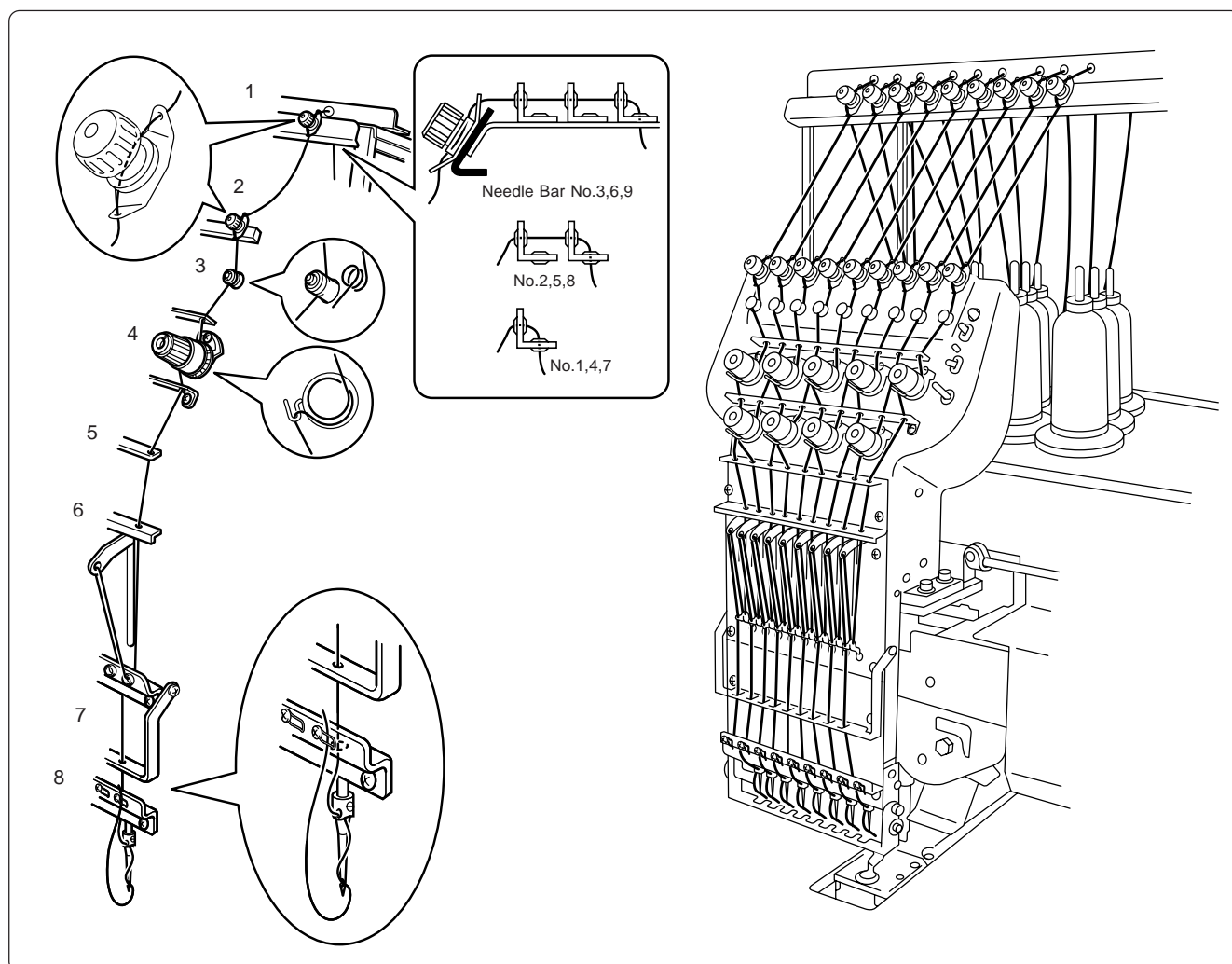

1. Pass the upper thread from the cotton stand through the hole of the thread guide right above each cotton stand bar from the lower side.
2. Pass the thread through the upper hole of the pretension. Push up the tension disc with your finger, and place the thread under the disc. Then, pass it through the lower hole.
3. Pass the thread through the upper hole of the 2nd pretension. Push up the tension disc with your finger, and place the thread under the disc. Then, pass it through the lower hole, and wind it around the thread breakage pulley twice.

4. Pass the thread through the hole of the upper thread guide (U), wind it into the tension disk clockwise once, and place it on the spring.
5. Pass the thread through each hole of the upper thread guide (U) and the thread guide (C).
6. After passing the thread through the hole of the thread guide (U), insert the thread into the right side of the inner thread guide, and pass it through the hole of the thread take-up.
7. Bring the thread to the inner thread guide again to insert it into the hole from the upper section, then into the lower thread guide.
8. Pass the thread through the hole of the needle bar thread guide, then pass it through the needle eye, without passing it through the presser foot.

■ BES-1260BC

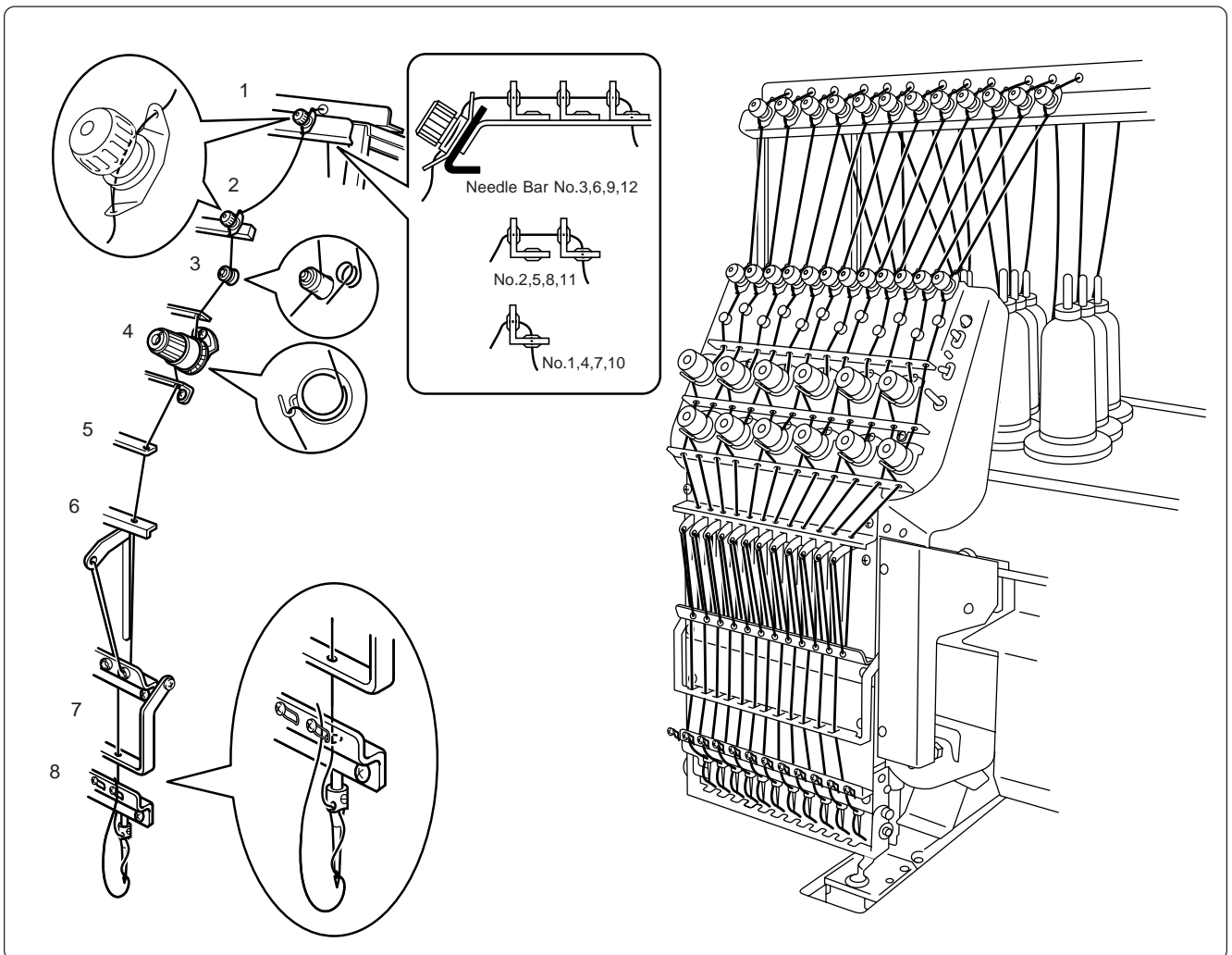

1. Pass the upper thread from the cotton stand through the hole of the thread guide right above each cotton stand bar from the lower side.
2. Pass the thread through the upper hole of the pretension. Push up the tension disc with your finger, and place the thread under the disc. Then, pass it through the lower hole.

3. Pass the thread through the upper hole of the 2nd pretension. Push up the tension disc with your finger, and place the thread under the disc. Then, pass it through the lower hole, and wind it around the thread breakage pulley twice.
4. Pass the thread through the hole of the upper thread guide (U), wind it into the tension disk clockwise once, and place it on the spring.
5. Pass the thread through each hole of the upper thread guide (U) and the thread guide (C).
6. After passing the thread through the hole of the thread guide (U), insert the thread into the right side of the inner thread guide, and pass it through the hole of the thread take-up.
7. Bring the thread to the inner thread guide again to insert it into the hole from the upper section, then into the lower thread guide.
8. Pass the thread through the hole of the needle bar thread guide, then pass it through the needle eye, without passing it through the presser foot.

4-2 Replacement of Bobbin

Note) Remove dust, lint and oil from the bobbin case before replacement.

■ Removing bobbin case

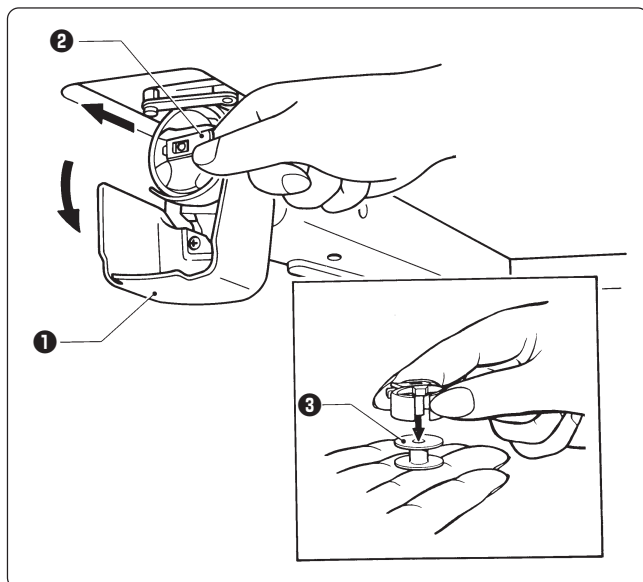

1. Open the rotary hook cover B ①.
2. Hold the knob ② and take out the bobbin case.
3. Close the knob and take out the bobbin ③.

■ Replacing bobbin

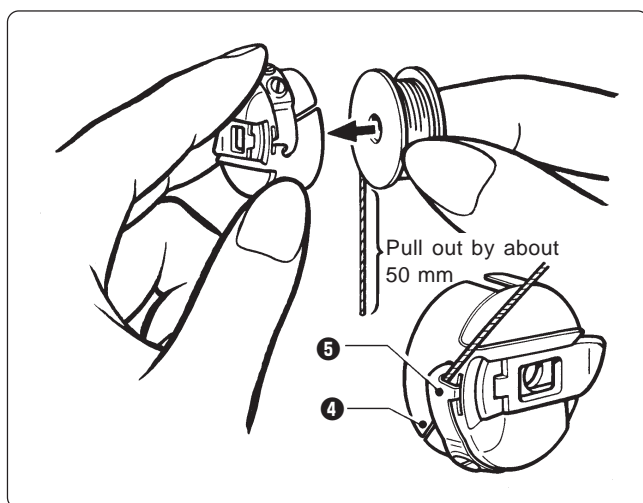

1. Put a new bobbin in the bobbin case.
2. Slide the thread under the tension spring ⑤ through the notch ④.
3. Pull out the thread from the hole of the tension spring ⑤.
4. Pull out the thread by about 50 mm.

■ Attaching bobbin case

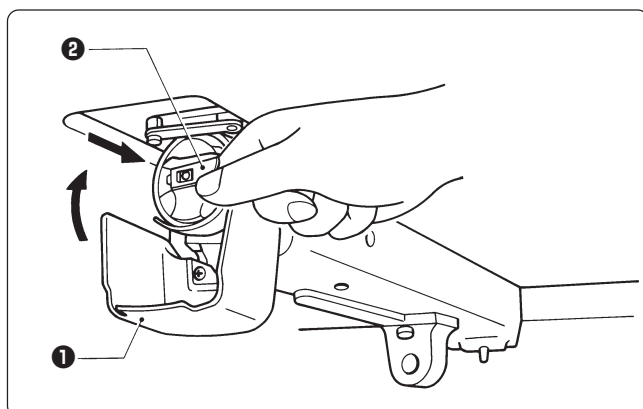

1. Hold the knob ② and attach the bobbin case securely.
2. Close the rotary hook cover B ①.

4-3 Replacing and Selecting Needle

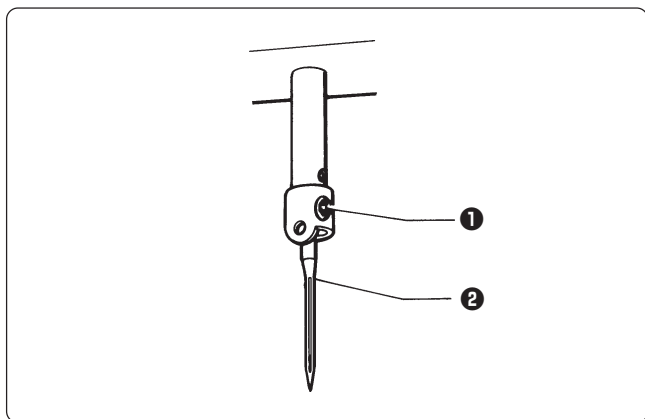

■ Removing needle

Loosen the set screw ❶ and remove the needle ❷.

■ Attaching needle

With the flat side facing the front, insert the needle all the way until it meets the end of the needle bar. Tighten the set screw ❶ firmly.

- Note)
- Set the needle so that the notched part will come on the rotary hook side.
 - The needle should not be angled to the left (when viewed from the front).

* Relationship between materials and needles

Material	Needle	Needle thickness
Denim Leather	DB x K5	#14, #16, #18
Handkerchief		#9, #10
Shirt Towel		#11, #12, #13

■ Selecting needle

- When using special threads such as gold, silver, and rame yarn, use a heavy-duty needle (#11 ~ #16). For better finish, paste the waxed paper on the back of the material.
- In general, use DBxK5 #11 ~ #18 according to the material thickness. For knitted materials, use DBxK23 #11 because its rounded point prevents the knit thread from breaking.

4-4 Attachment of Embroidery Hoop and Frame

■ Tubular square hoop

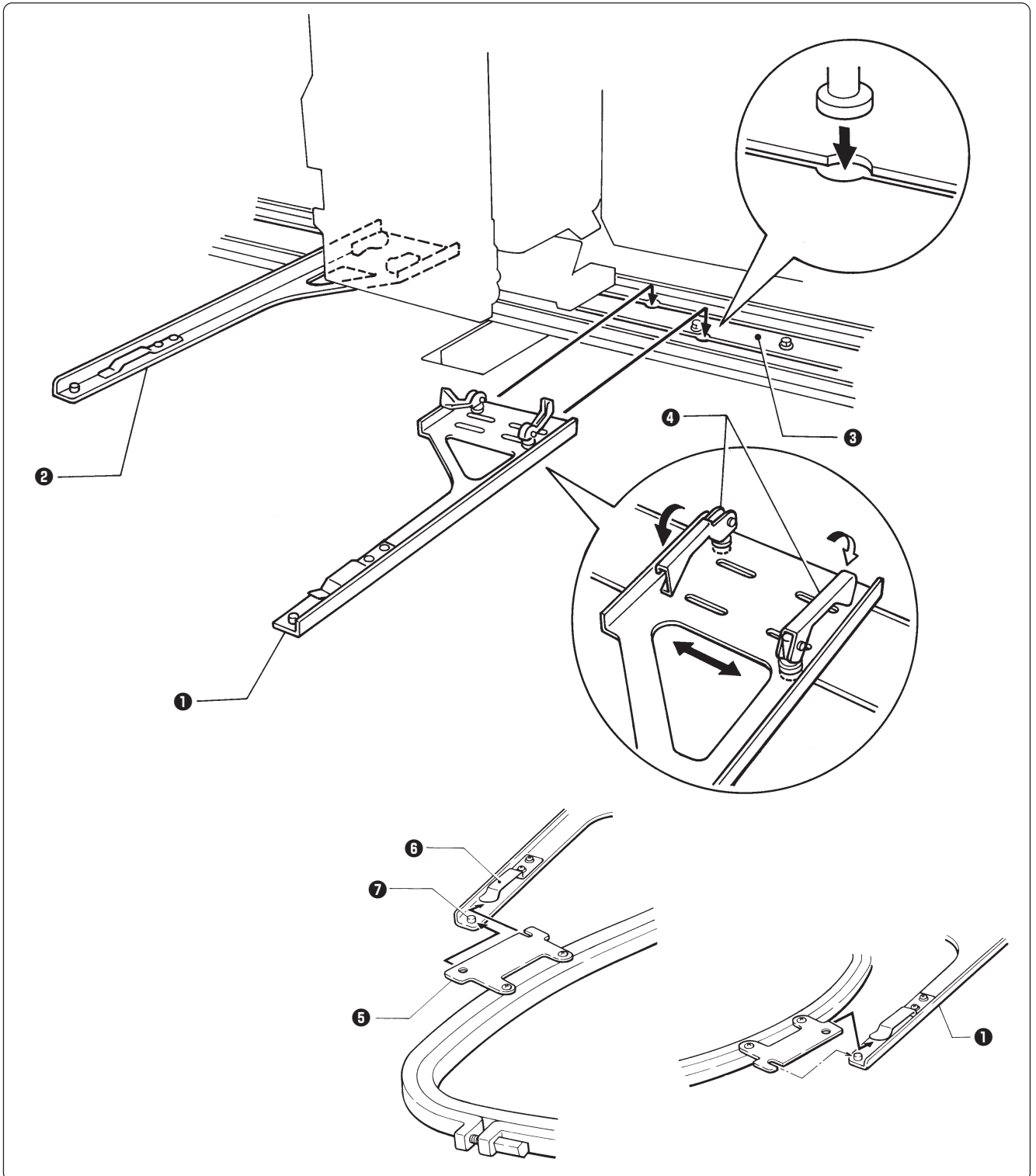

1. Insert the fixing pins of the tubular round arms R **1** and L **2** into the notches of the X-axis feed frame **3**. Slide the arm to the right and left and lower the fixing lever **4** to fix them.
2. Set the right and left fixtures of the tubular square hoop **5** while sliding them under the flat spring **6** upward. Then fit the frame projecting part **7** into the hole of the tubular square hoop **5** securely.

- By changing the tubular round arm mounting width, various sizes can be set.

Note) Change the width, referring to the pin position.

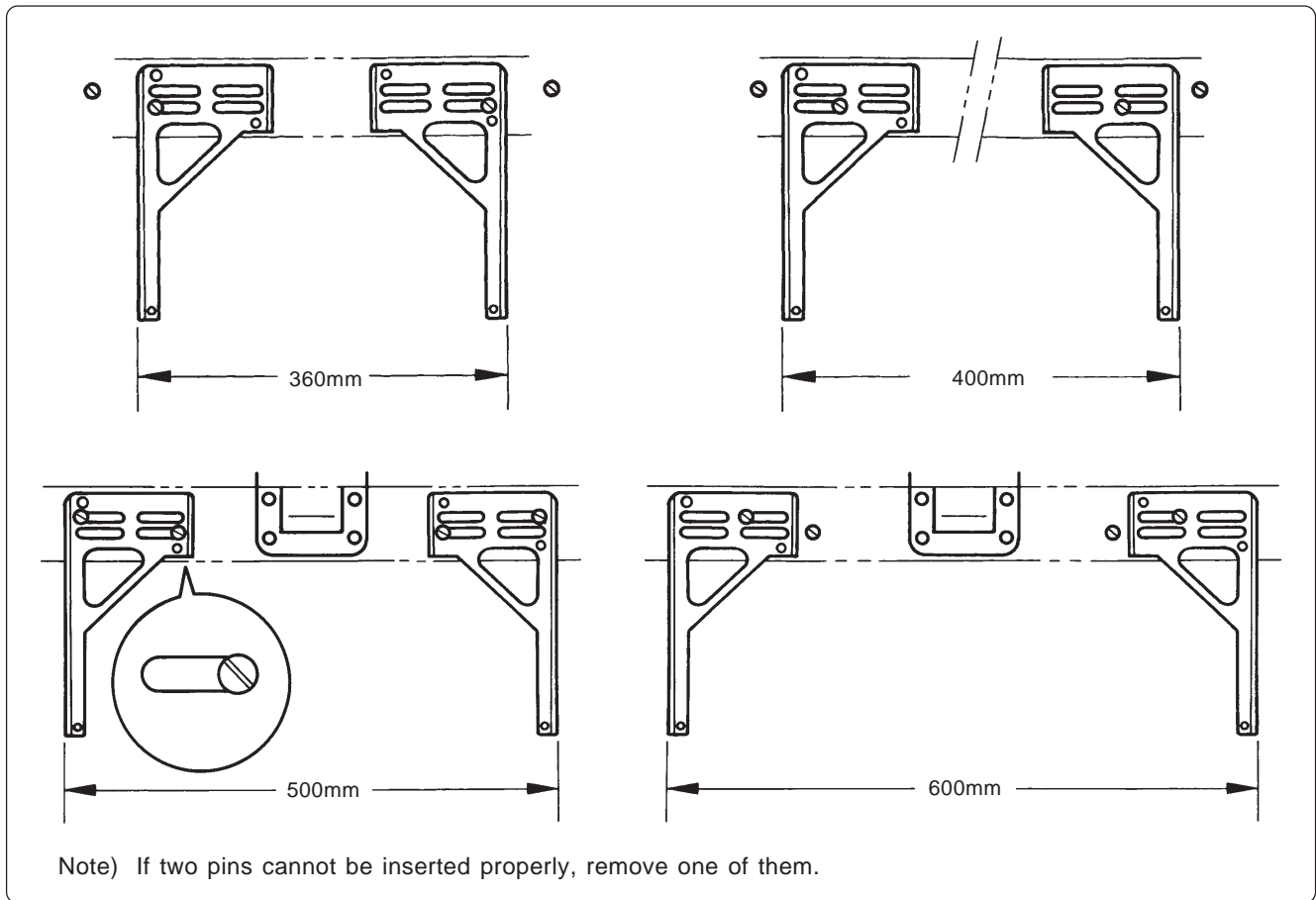

■ Holder base (optional)

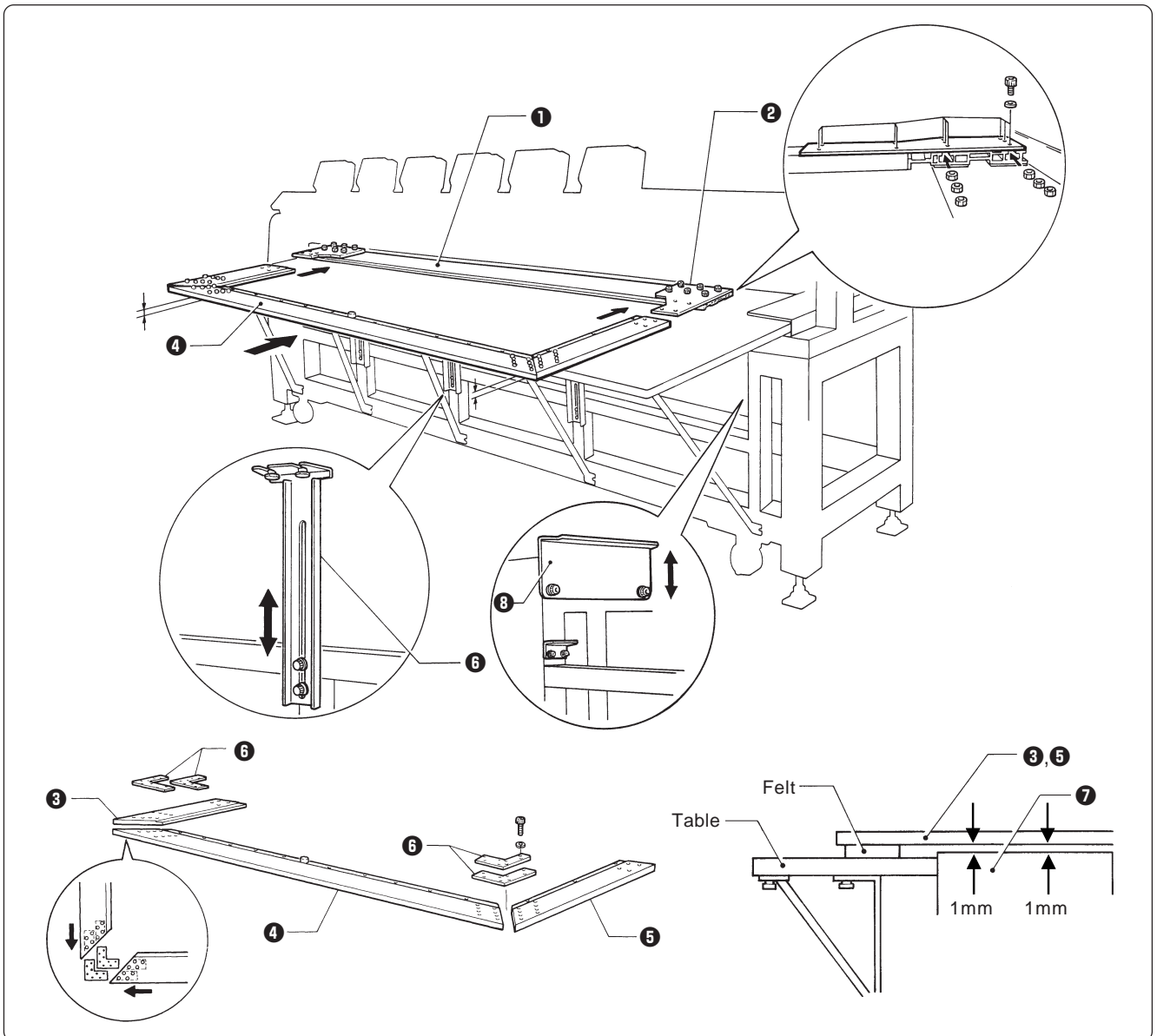

Attaching the holder base frame

1. Set the table. (Refer to "3-4 Mounting of Table" (Page 26) for details.)
2. Mount the frame connecting plate R **2** on the X-axis feed frame **1**, using six bolts, washers, and nuts.
3. Insert the frame connecting plate **6** into the holder base frame L **3**, holder base frame C **4**, and holder base frame R **5**, using bolts and washers.
4. From the front, put the holder base frame C assembly **4** under the frame connecting plate R **2** and fix it using four bolts.
5. Check that the clearance between the table and the mounted holder base frame C assembly **4** is even when viewed from the machine front.

[Adjustment] Loosen three bolts of the F table support F **6** and move it in the direction of the arrow for adjustment.

6. Check that the clearance between the Y-axis cover **7** and the mounted holder base frames L **3** and R **5** is even when viewed from the right and left sides.

[Adjustment] Loosen the right and left bolts of the F table guide U **8** and move it in the direction of arrow for adjustment.

7. Tighten each bolt securely after adjustment is finished.

Attaching the holder base

1. Mount the holder base mounting frame **3** on the X-axis feed frame **1** and holder base frame C **2**, using three clamp screws.
2. When the mounting pitch of the holder base is 370 mm, mount the holder base horizontally to the holder base mounting frames **3** using the thumb bolts **4**.

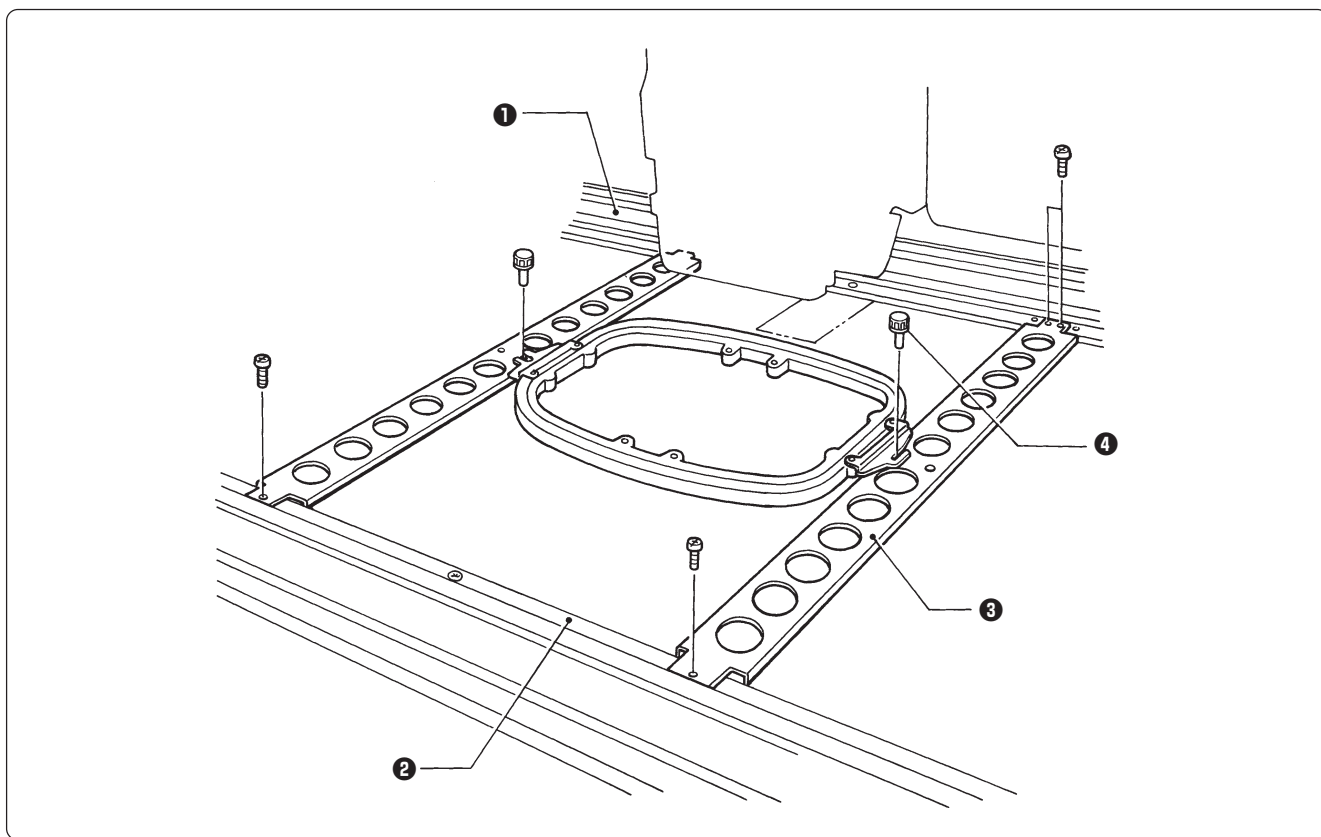

3. When the mounting pitch of the holder base is 550 mm, mount the holder base vertically to the X-axis feed frame **1** and holder base frame C **2** using the thumb bolts **4**.

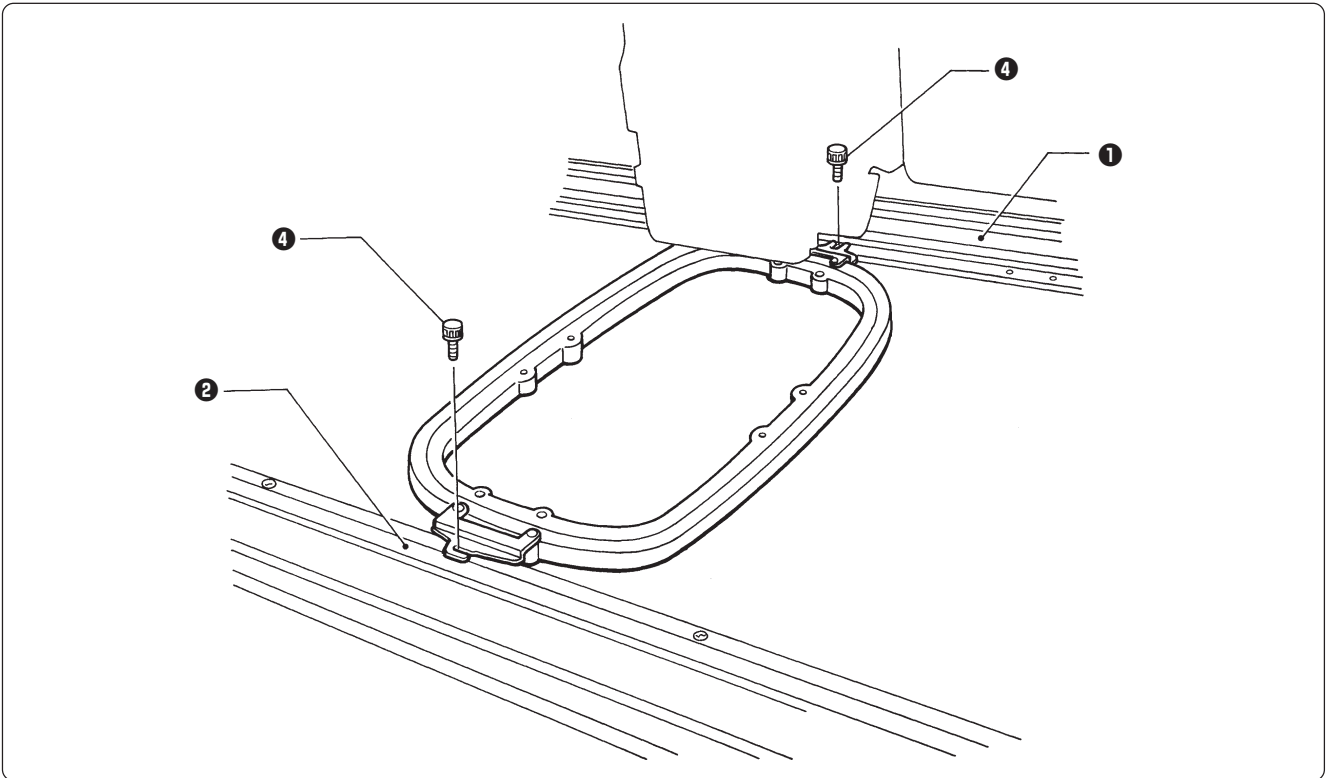

■ Sash frame (optional)

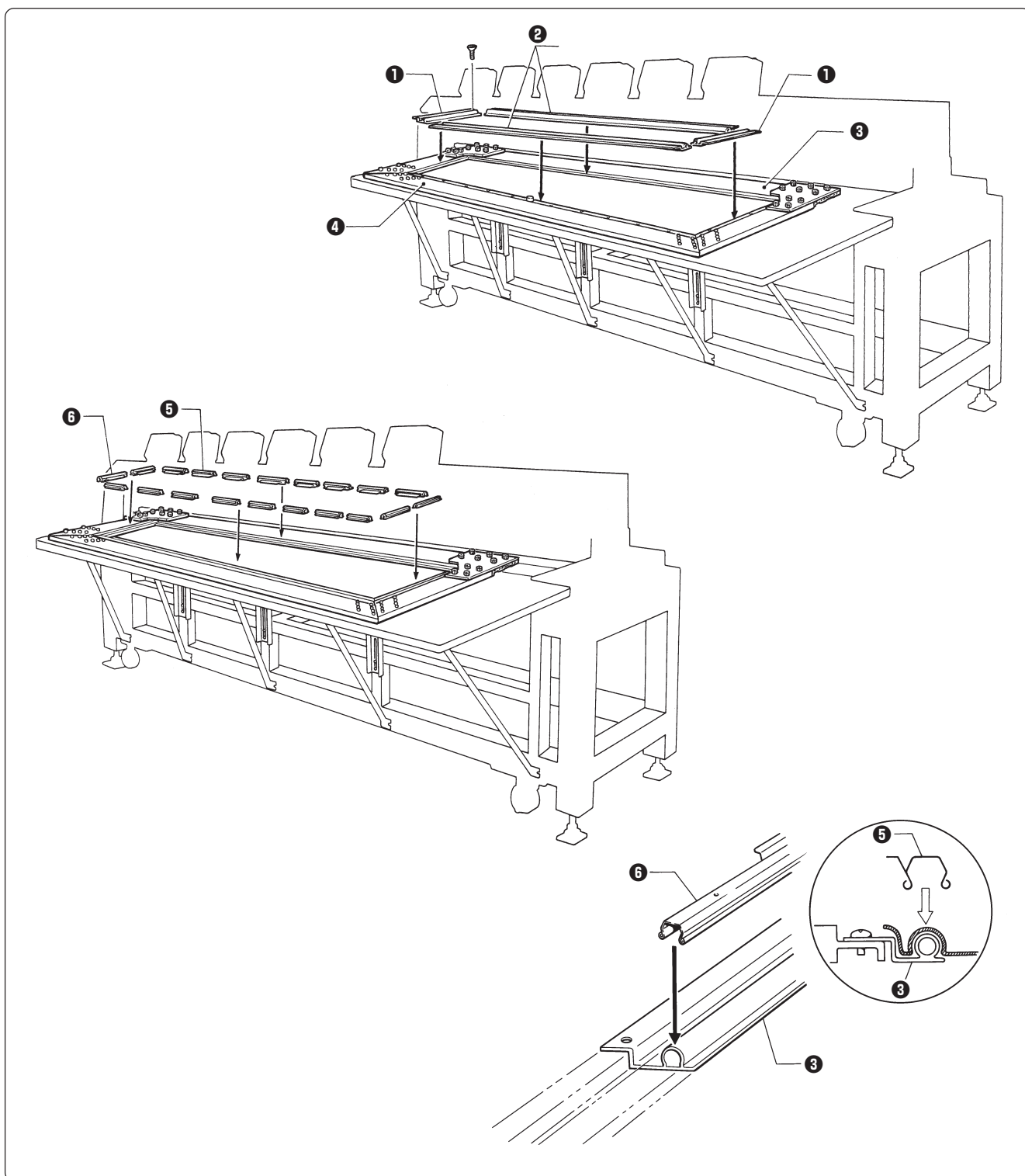

Attaching the sash frame

1. Set the table. (Refer to "3-4 Mounting of Table" (Page 26) for details.)
2. Mount two vertical sash frames ① on the holder base frames L and R, and two horizontal sash frames ② on the X-axis feed frame ③ and the holder base frame C ④, using the screws.
3. Set the material. Then, set 16 clips 290 ⑥ horizontally in two sides and 4 clips 220 ⑥ vertically on the right and left sides.

4-5 Bed Retract

When embroidery within the maximum area by mounting the tubular square hoop, there is a possibility that the hoop interferes with the bed. Retract the bed of several machine heads to avoid interference. Machine heads with an even number enter a halt status.

Note) The machine heads are numbered 1 ~ 6 from the right side.

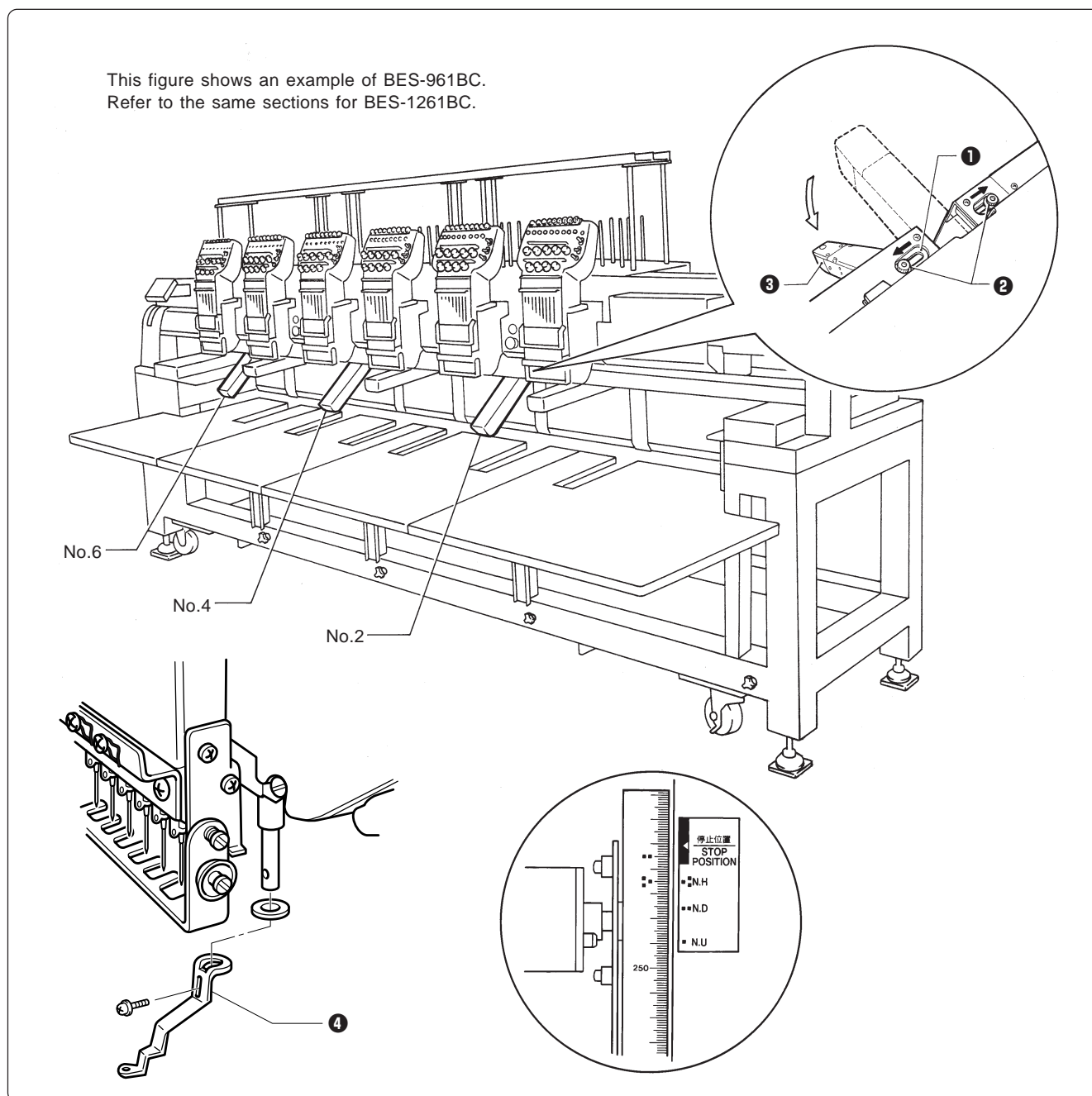

1. Loosen two bolts **②** that secure the bed support **①**, and move the bolts **②** to the right and left.

Note) • The bed is secured by two bolts and supported at three places.
• When loosening the bolts, support the bed by hand.

2. Lower the machine bed **③** slowly until it comes into contact with the leg.
3. Tighten the bolts **②** again.

4. Set the needle bar case at the needle bar No. 1. Remove the presser foot ❷ from the retracted machine bed.

- Note)
- The head of the retracted bed is stopped.
 - When removing the presser foot, align the pulley indication mark ■ first.
 - To operate the machine in retract position, set the bed in contact with the legs.

Resetting of bed retract

1. Move the machine bed ❸ little by little until it comes into contact with the bed support ❶.
2. Loosen two bolts ❹ and insert the bed into the right and left directions, then tighten the bolts securely again.
3. Mount the presser foot for the reset bed ❸.
(Refer to "Chapter 8. Standard Adjustment" for mounting the presser foot.)

4-6 Adjustment of Thread Tension

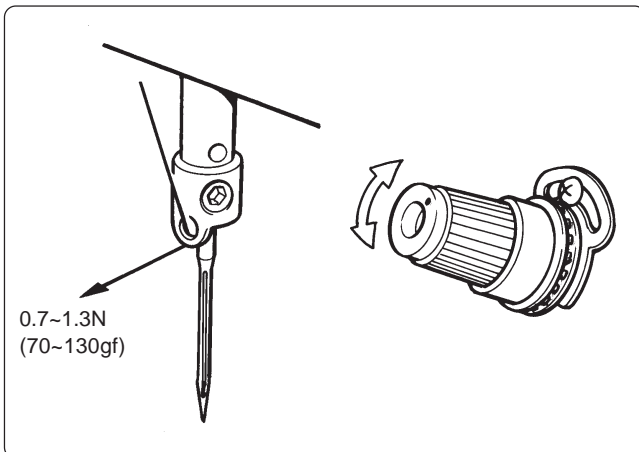

■ Adjustment of upper thread

Adjust upper thread tension to 0.7~1.3N (70~130 gf) when the thread is pulled at the needle bar thread guide.

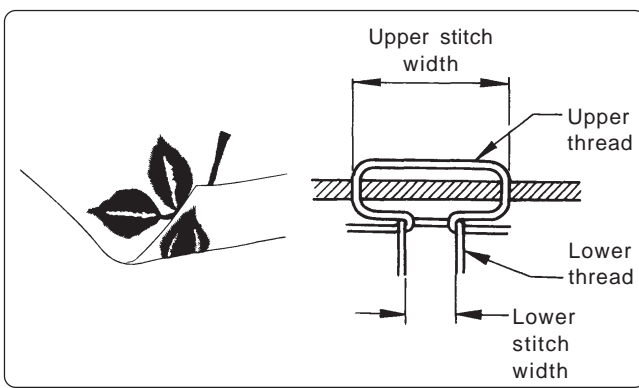

* Correct adjustment

Turn the upper thread tension dial so that the needle thread can be pulled to the back of the material and that the lower stitch width will be about 1/3 of the upper stitch width.

■ Adjustment of tension spring

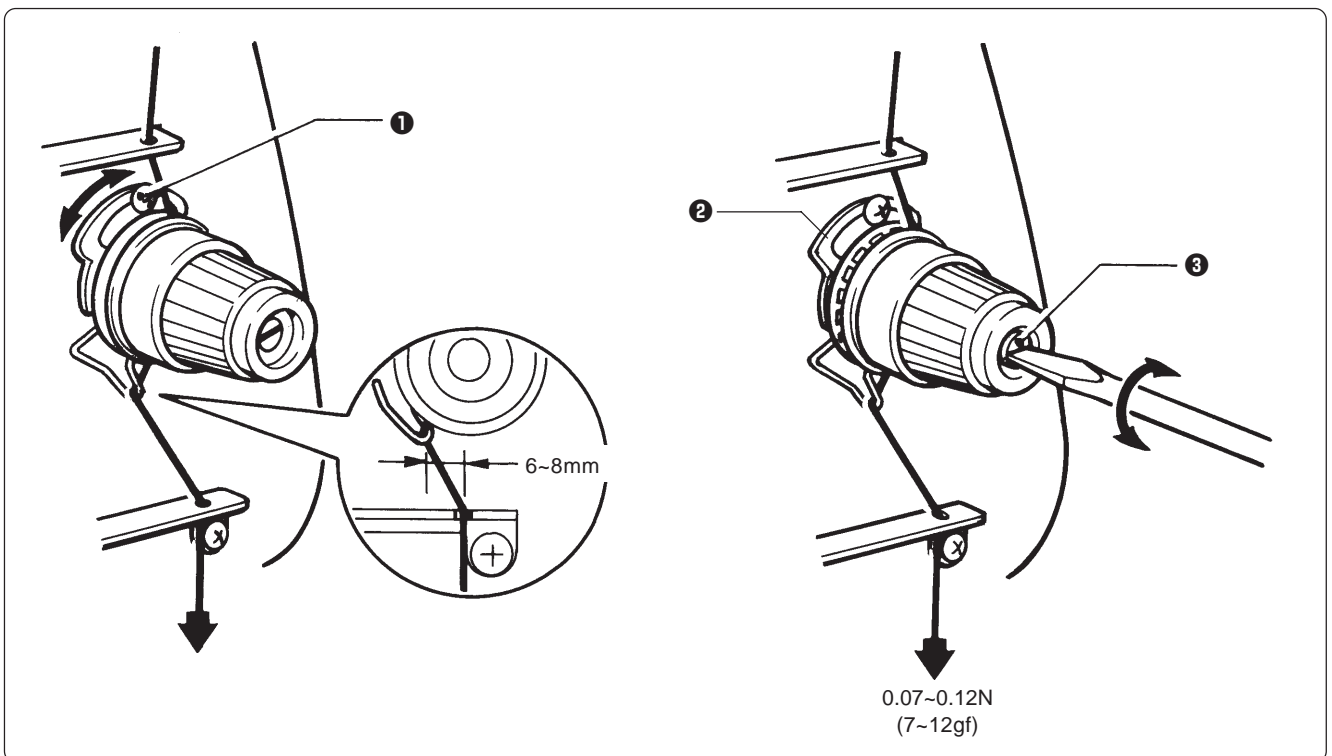

1. The tension spring should be adjusted to 6~8 mm in height and 0.07~0.12 N (7~12 gf) in force.

2. For adjusting the height, loosen the screw ❶ and turn the tension spring bracket ❷.
3. For adjusting the tension spring force, insert a driver tip in the groove of the thread tension bar ❸ and turn it.

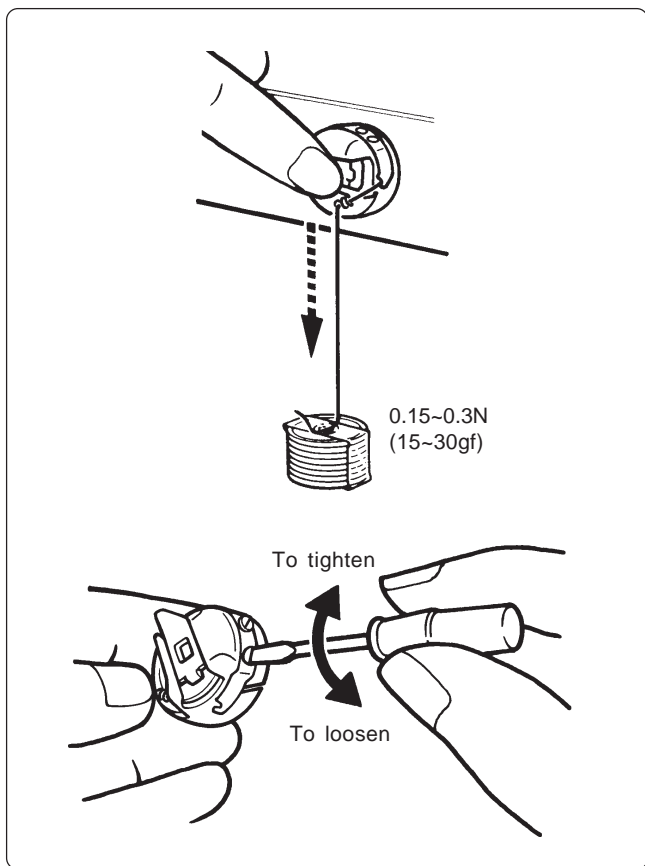

■ Lower thread tension

The standard tension of the lower thread is 0.15~ 0.3N (15~30gf).

This tension may vary depending on the used thread. In general, press the bobbin case to a smooth vertical surface and hang the designated number of coins. Turn the thread tension screw so that the lower thread will come out smoothly.



Chapter 2

Embroidering Procedures

After installation of machine start embroidering. This chapter explains about the operation panel on the machine as well as precautions for the actual embroidering process.

Functions of Operation Panel

Operation Panel

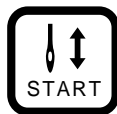
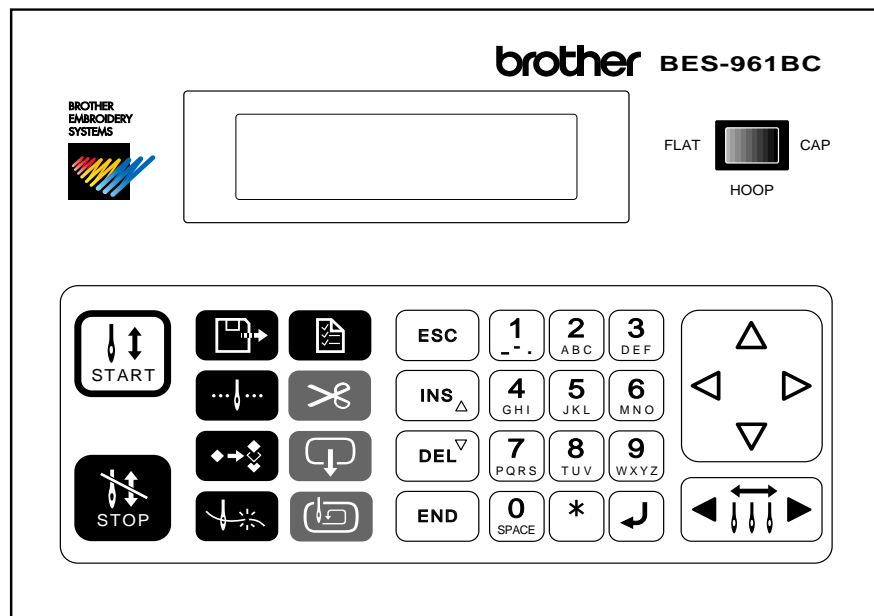

Starts embroidering.

Restarts after moving the carriage to embroidering start position by using the jog switch.

Restarts embroidering after a suspension.



Cancels errors during embroidering.

Suspends embroidering.



Selects sewing data. (→ "Chapter 3 Selection of Data and Embroidering" page 59)



Specifies a sequence of colors (sequence of needle changes) in sewing data.
(→ "Setting of Needle Bars" page 92)



Edits sewing data. (→ "Chapter 4 Editing of Embroidering Data" page 77)



Sets the upper thread breakage sensor. (→ "Thread Breakage Sensor" page 93)



Machine motions can be set. (→ "Chapter 5 Setting" page 89)



Trims thread during suspension.



Moves the hoop to a preset hoop retract position. When this switch is pressed again, the hoop returns to the previous position.



Checks the embroidering area.

Moves the hoop automatically into the embroidering area when the embroidery position is out of the area.



Used for selecting data and setting functions.



Selects the flat or cap hoop. This selection should be done before turning the power ON to the machine. Selection after turning the power ON may damage the hoop.

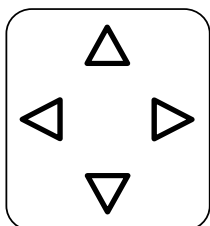

Moves the hoop.

Step-back or forward is available during suspension, by one stitch every time the switch is pressed (Use ◀▶ switches only.)

Changes the speed range during embroidering (Use ▲▼ switches only).

Carries out inching of the hoop when the switch is pressed in the inching mode

Move the cursor for selecting sewing data and an icon.

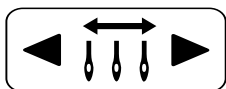

Moves the needle bar. The needle moves by the diameter every time this switch is pressed.

Change to the screen for selecting sewing data.

Operation panel

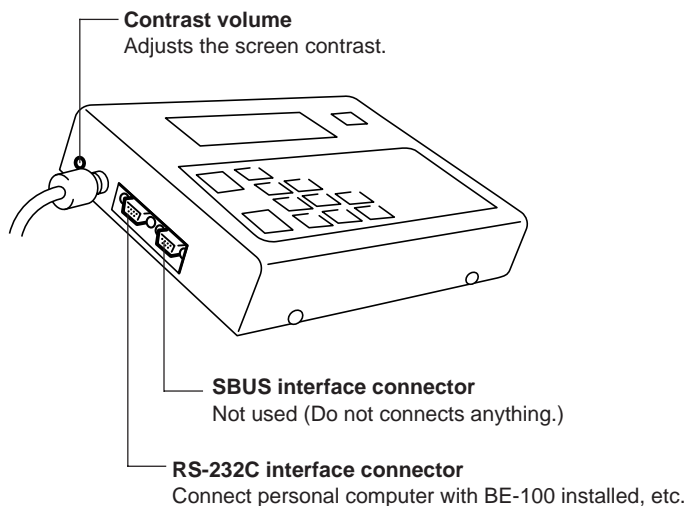

Switches at Machine Heads

BES-961BC

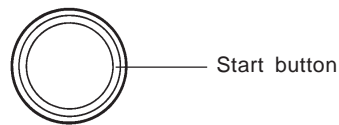

Start button

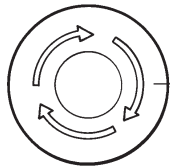

Emergency stop button

BES-1261BC

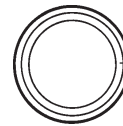

Start button

■ Emergency stop button

Stops embroidering operation. "Emergency stopping" is displayed on the screen as soon as the machine stops.

Refer to "Resetting Emergency Stop" (→ page 119) to stop flashing.

■ Start button

Starts embroidering. Holding down this button executes embroidering at a low speed.

When resuming embroidering after an emergency stop, release emergency stop before pressing this button. Refer to "Resetting Emergency Stop" (→ page 119) for details.

Switches on Tension Plate

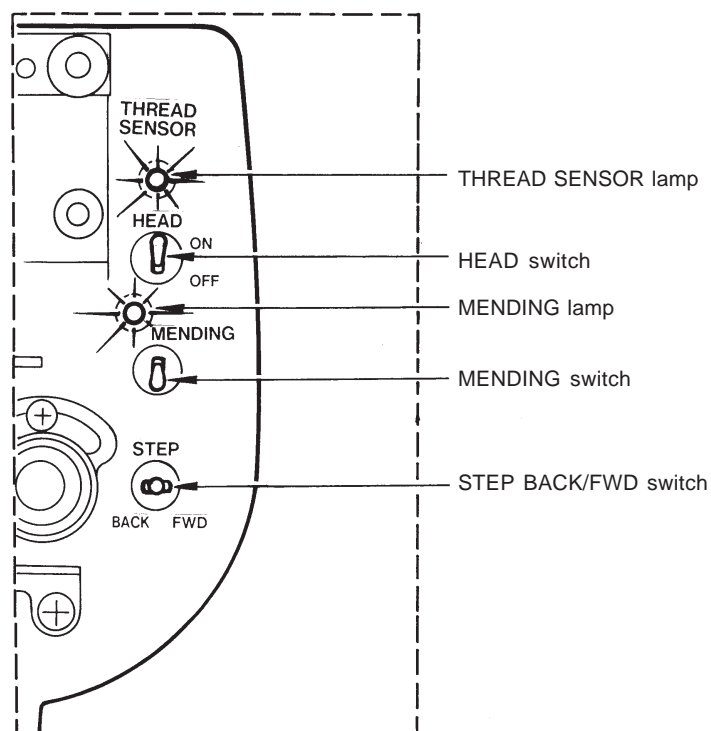

■ **THREAD SENSOR lamp**

When red light is on, thread breakage sensor is functioning. When the light is off, the sensor is not effective. When the embroidery machine stops due to thread breakage, the lamp flashes.

■ **HEAD switch**

When it is set to ON, needle bar on the head moves for embroidering. When it is set to OFF, the needle bar does not move for embroidering.

■ **MENDING lamp**

This lamp lights up when the embroidery machine is in the mending mode.

A lamp on the head with an error lights up. (only when the error can be located)

■ **MENDING switch**

This switch is set to upside to drive or to suspend the machine head during embroidering for a designated period of time.

■ **STEP BACK/FWD switch**

When it is turned to BACK, the machine steps back. When it is turned to FWD, the machine steps forward. If you keep the switch turned for a while, the machine will continue stepping even after you let the switch alone. When it is turned to the opposite side, the machine stops.

During timing adjustment of the rotary hook in the test mode, the rotary hook slightly rotates to the left/right when this switch is turned to left/right respectively. Refer to "Adjustment of timing Between Needle and Rotary Hook" (→ page 144) for further details.

If any error occurs, it can be reset.

Flowchart of Preparation for Embroidering

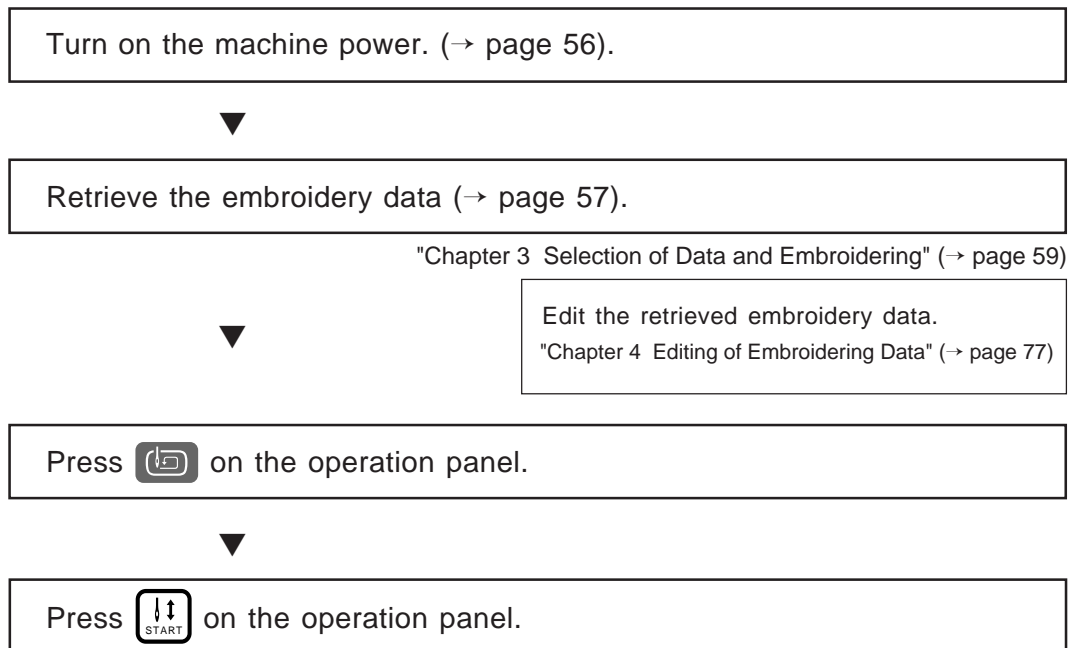

Turn on the Machine Power

1. Turn on the power to the machine.

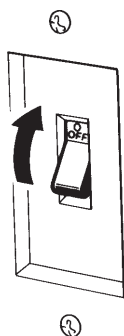

2. A message is displayed on the LCD as soon as the power is turned ON.



BES-961BC



BES-1261BC



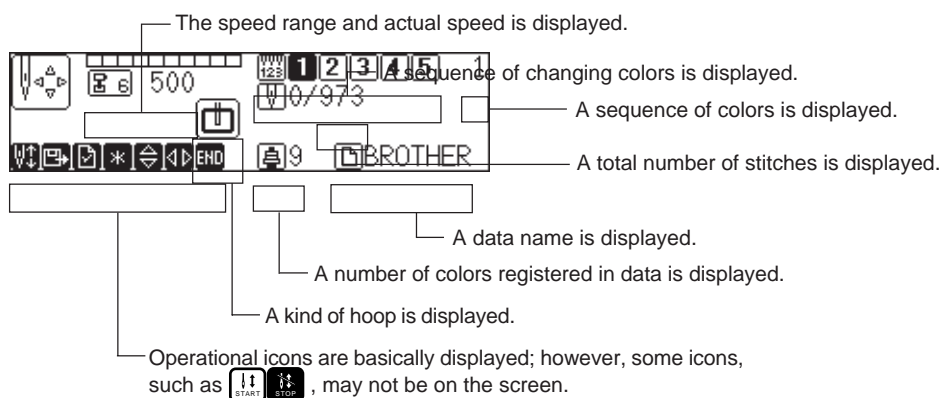



3. The alarm sounds three times. The needle bar and the presser foot move up. The hoop moves back to the zero point and the sewing screen is displayed.



Retrieve the Embroidery Data

The description in this section is based on the method of reading data which is registered in the memory unit of the machine.

Refer to "Selection of Data" (→ Page 61) for details.

1. Press  switch.
Data saved in the machine is displayed.
2. Select a screen by pressing   keys, and select required data by pressing ten keys or    .

When using ten keys for data selection, input a numerical figure (1 ~ 9) which indicates each data name. Required embroidery data is selected and read.



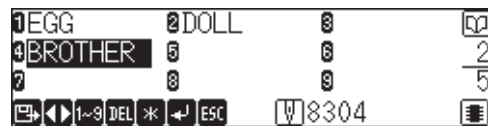

3. Press  key.
Required embroidery data is selected and read.

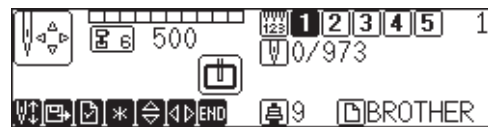

Selected embroidery data is read.



Start Embroidering

1. Press  to check the embroidering area.
2. Press  to start embroidering.



Sewing is started and the next screen is displayed.

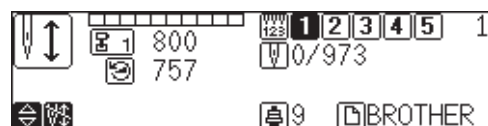







Chapter 3

Selection of Data and Embroidering





This Chapter describes how to select embroidery data in order to start embroidering.

What Can the Machine Do?

Selection of Embroidery Data

	Registration of data from the floppy disk (→ Page 61)
	Reading of data from the memory (→ Page 64)
	Registration of data created by BE-100 (→ Page 65)
(These icons are displayed in the lower right of the screen.)	
	Modification of data name (→ Page 68)
	Deletion of embroidery data (→ Page 66)

Embroidering Operation

	Embroidering start (→ Page 72)
	Embroidering feedhold (→ Page 73)
	Embroidering cancel (→ Page 73)
	Step forward/step back (→ Page 74)
	Step forward (back) stitch by stitch
	Step forward (back) by every 10 stitches
	Step forward (back) by every 100 stitches
	Step forward (back) until a next color change
	Step forward (back) to the embroidering start point of a next pattern
B↔F Designate stitch nos (<input type="text"/> / ****)	Step forward (back) by a specified number of stitches (→ Page 74)

Selection of Data

Select data in order to start sewing.

- Data to use for actual embroidering is selected from data registered in the machine memory. A maximum of 45 kinds or 480,000 stitches of embroidery data can be registered in the machine memory; however, depending on the combination of embroidery data, the number of total stitches available may become less.
- When using data in a floppy disk or in BE-100, register it in the machine memory once before selection.
If there is no space in the machine memory, delete unnecessary data to make a space.

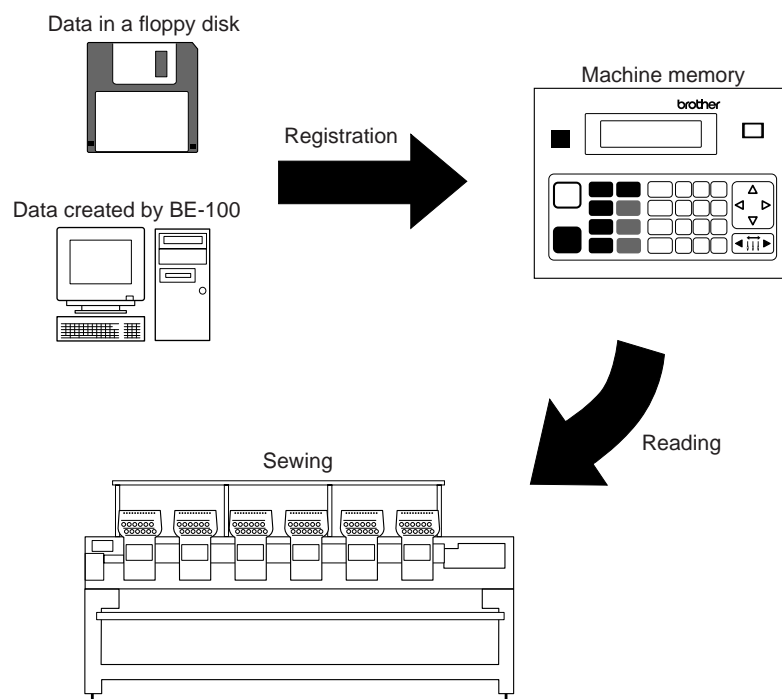

Registration of Embroidery Data from Floppy Disk



Register embroidery data from a floppy disk into the machine memory.

- Types of data to be registered are as shown below.
 - DOS-formatted data

Data format	Extension	Icon
ECS	Data with a name of [xxxx.ECS]	
Tajima	Data with a name of [xxxx.DST]	
Barudan	Data with a name of [xxxx.DSB]	
Zanks (DSK)	Data with a name of [xxxx.DSZ]	
Data received from BE-100	Data with a name of [xxxx.STH]	

(These icons are displayed in the lower right of the screen.)

• Other data

Data format	Icon
Barudan FDR	
Barudan FMC	

(These icons are displayed in the lower right of the screen.)

Loading and Loading of Floppy Disk

1. When loading a floppy disk, set it straight with the labeled surface facing this side.

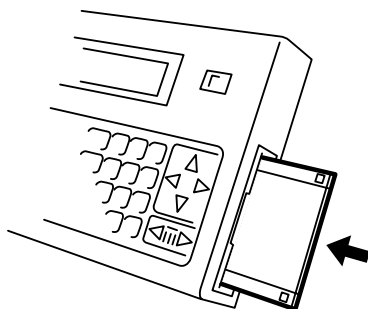

2. When unloading a floppy disk, press the eject switch.
3. When it comes out, pull it straight.
When the access lamp is ON, never press the eject switch. Otherwise, embroidery data in the floppy disk may be destroyed.

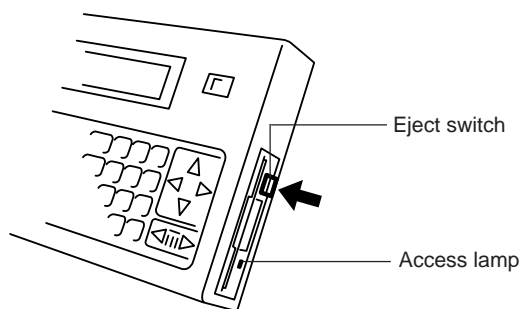

Registration of Sewing Data into Machine Memory

1. Load a floppy disk with sewing data.

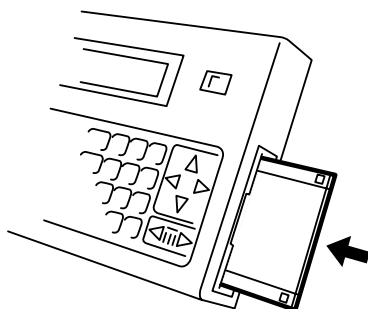

2. Press .

3. Select a screen for data registration by pressing .

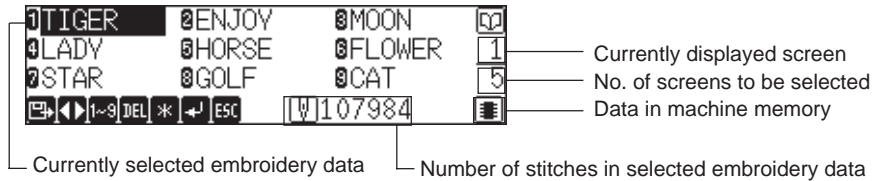

When there is no data

4. Select an area for registration, using ten keys or , then press .

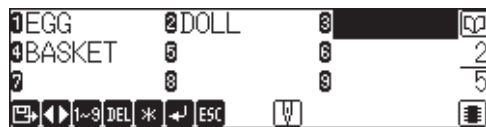

A space available is automatically selected.

Pressing  automatically locates the first space in the memory.

5. Data in the floppy disk is displayed. Press  to select a screen.

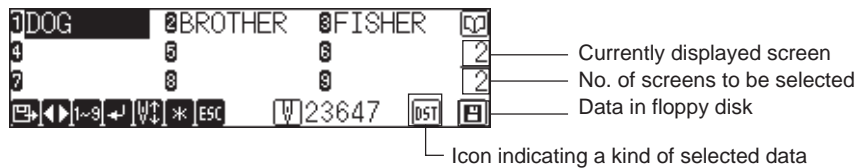

Pressing  displays a pattern name.



Name of a selected embroidery pattern
(It may be the same as a file name.)

6. Select data to register by pressing ten keys or  then press .

Data is newly registered in the machine memory.



Select embroidery data and press . The selected data is automatically registered in the memory and the machine enters a standby status.

If registration is done without loading a floppy disk, the following screen is displayed after the step 4 is finished.

Load a floppy disk for data registration.



Reading from Memory

Data to use for sewing can be selected from the machine memory.

- A maximum 45 kinds or 480,000 stitches of embroidery data can be registered in the memory.

1. Press  .
Embroidery data registered in the memory is displayed.

2. Select a screen by pressing  .



3. Select embroidery data to read by pressing ten keys or    .

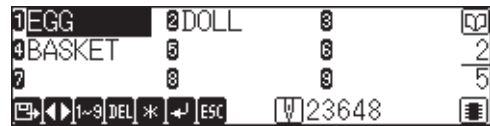

4. Press  .
Embroidery data is selected and read.

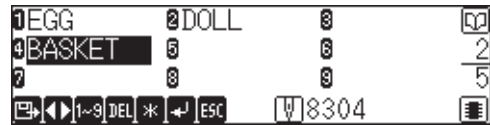

When a free space is specified in the memory, a screen for reading data from the floppy disk is displayed.

Refer to "Registration of Sewing Data into Machine Memory" (steps 5 and afterward on Page 63).

5. The initial screen is displayed.







Registration of Embroidery Data from BE-100

Connect the operation panel and the personal computer with BE-100 installed in order to register the embroidery data into the machine memory.

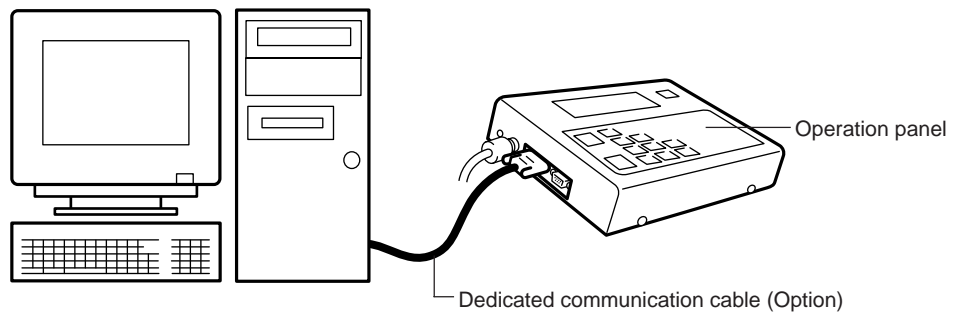



1. Connect the personal computer with BE-100 installed and the operation panel by means of the RS-232C cable.

Personal computer with BE-100 installed



2. Press the .
3. Select the data registration screen by pressing the  .



4. Select an area for data registration by pressing ten keys or    , and then press the  key.

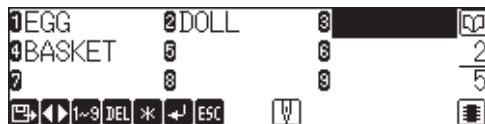

5. Press the .



When a floppy disk is set



When no floppy disk is set

6. Press the ◀▶.

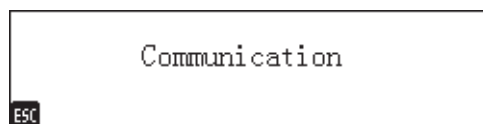
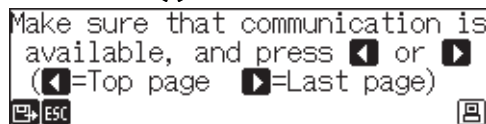

7. The BE-100 embroidery data is displayed. Press the ◀▶ and select a required screen.



8. Select embroidery data to register by pressing ten keys or ▲▼◀▶, and then press the ↵ key.

The data is registered in the machine memory.



Deletion of Embroidery Data from Machine Memory

Embroidery data can be deleted from the machine memory.

1. Press .
A list of registered data is displayed.

2. Select a screen by pressing ◀▶.



—— Currently displayed screen
—— No. of screens to be selected

3. Select embroidery data to delete by pressing ten keys or ▲▼◀▶.



4. Press **DEL**.

Selected embroidery data is deleted from the memory.

Deleting...



1	TIGER	2	ENJOY	3	MOON	
4	LADY	5		6	FLOWER	1
7	STAR	8	GOLF	9	CAT	5
[Exit] [Left] [Right] [1-9] [DEL] [*] [Left] [ESC]						[List]

When deleting embroidery data in the machine memory entirely:

When deleting embroidery data registered in the machine memory entirely, turn ON the power to the machine while pressing **DEL**.

Modification of Embroidery Data Name

Name of embroidery data registered in the machine memory can be modified.

This example shows how to modify the data name "FLOWER" to "TEST003".

- A maximum number of characters to use for an embroidery data name is 8.
- The following kinds of characters can be used.
- It is impossible to input a " . " or space.

Alphabetical characters (A ~ Z) Numerical characters (0 ~ 9)

Use **0** through **9**. An input character changes depending on the number of times each is pressed as shown below.

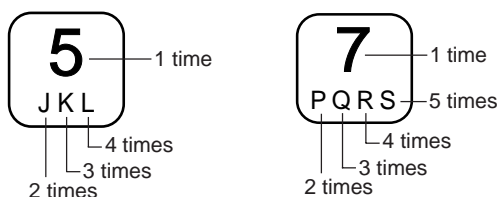

_ (underbar), - (hyphen)

Use **1**.

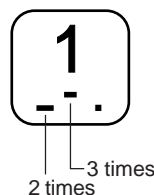

1. Press . Embroidery data saved in the memory is displayed.
2. A list of embroidery data is displayed. Select a screen by pressing .



3. Select embroidery data to modify the name by pressing ten keys or .
4. Press *****.



When selected data has a pattern name, the name is displayed. Press the ***** key once again.



5. Input a new data name by pressing ten keys.

When modifying embroidery data names entirely

6. Pressing **DEL** deletes currently reversed characters.

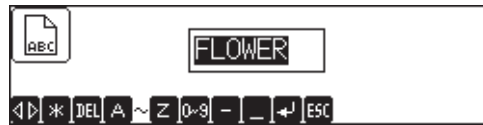

7. Press **8** twice.

"T" is input.

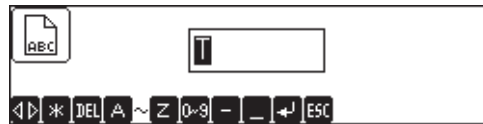

8. Press **3** three times.

"E" is input.

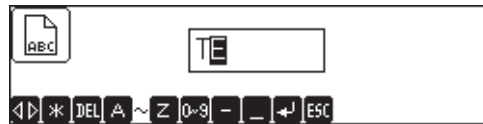

9. Press **7** five times.

"S" is input.

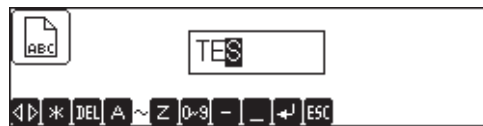

10. Press **8** twice.

"T" is input.



11. Press **0** once.

"O" is input.



12. Press \triangleright .

When inputting the same character continuously, press the \triangleright to move the cursor to the right.

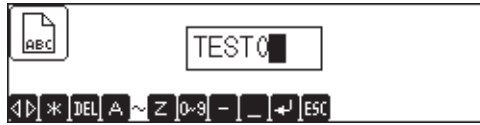

13. Press 0_{SPACE} once.

"0" is input.



14. Press 3_{DEF} once.

"3" is input.



15. After inputting a data name, press J .

A data name is modified by the above procedures.



When modifying only one character:

[FLNWER] can be modified to [FLOWER] in the following procedures.

6. Press \triangleleft .



7. Press \triangleright twice and display "N" reversely.



8. Press DEL .

"N" is deleted.



9. Press  four times.
"O" is input.

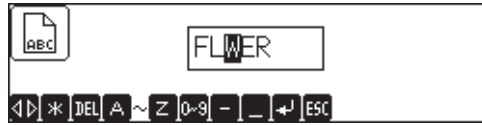

10. Press .

A data name is modified by the above procedures.

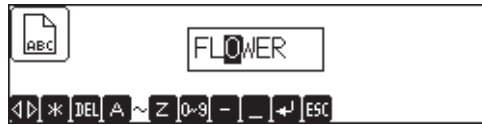

Sewing Operation

Before Starting Sewing

Select a hoop to set on the machine.

■ The following operation should be done before turning the power ON to the machine. Otherwise, it will damage the hoop.

1. Select either the flat hoop or cap hoop, using FLAT or CAP switch on the operation panel.

When a flat or tabular hoop, or a sash frame is set on the machine, select [FLAT].



When a cap hoop is set, select [CAP].



2. Specify an embroidery hoop set on the machine, referring to "Embroidery Hoop" (→ Page 96).

Starting Sewing Operation

■ For details of specifying a sewing start position, refer to "Registration of Sewing Start Position" (→ Page 104).

■ When  is pressed while the message "Area over" is indicated on the screen, a dialog box is displayed for confirming whether or not to start sewing forcibly. Pressing  starts sewing; however, depending on the start position, an interference with the frame may occur. Exercise added care when doing so.

1. Check that sewing data has been selected, then press . Sewing is started.

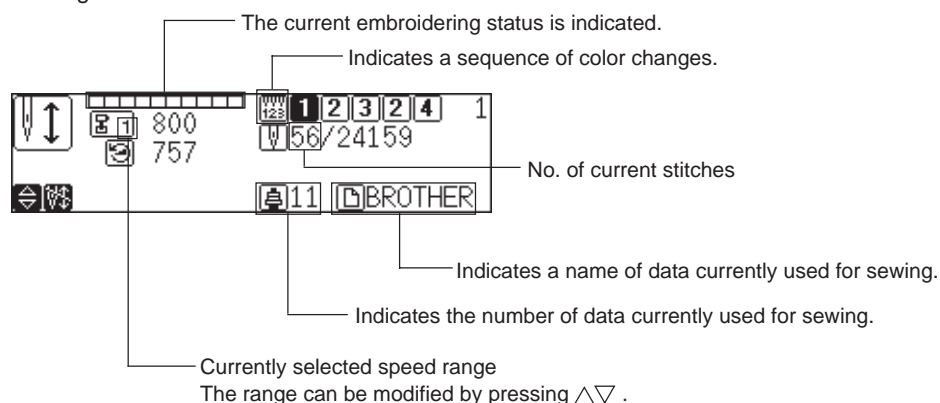

Feedhold and Cancellation of Sewing

Feedhold

1. Press .

Sewing is interrupted.

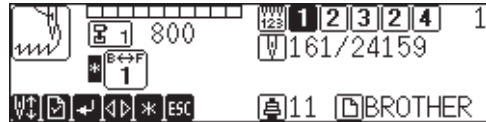

Cancellation

1. Press while sewing is interrupted.

When repetition of patterns is set, a pattern which is currently being sewn is canceled. When canceling all patterns, press once again.

2. A message for confirmation is displayed. When canceling sewing, press .



Step Forward and Step-Back





Stitches can be advanced (step forward) or retracted (step-back) without sewing.

Step Forward/Step-Back Mode

1. Press ***** when selecting either mode before starting sewing and press  when selecting a mode during sewing.

Setting Amount or Timing of Step Forward/Step-Back

A step forward/step-back amount or timing can be selected as described below.

	For stepping forward (back) stitch by stitch
	For stepping forward (back) by 10 stitches
	For stepping forward (back) by 100 stitches
	For stepping forward (back) up to the next (previous) color change
	For stepping forward up to the sewing start point of a next pattern if repetition of patterns is set.
B↔F Designate stitch nos (<input type="text"/> / ****)	Specify the number of stitches for stepping forward (back).

1. Select a required item as described above by pressing *****.

When the number of stitches is specified, the needle steps forward (back) to an input position:

1. Press the ***** five times.
2. Input the number of stitches to move by pressing ten keys.

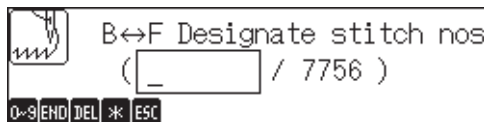

3. Press the **END**.
The needle steps forward (back) as specified.

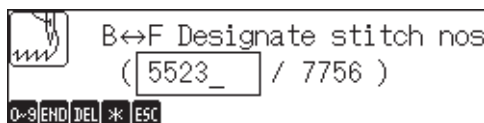

- The embroidery head advances (retracts) by a specified number of stitches.

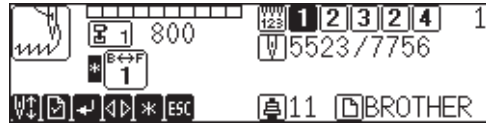

For Step Forward (Back)

- Press  .
Stitches steps forward (back) by a specified amount.

Resuming Sewing

- Press  .
Sewing is started.



Chapter 4

























Editing of Embroidering Data

Pressing  on the operation panel after reading embroidering data displays the embroidering data editing screen. Simple operation by using embroidering data is available on this screen.

What Can the Machine Do?

Editing

- Enlargement/reduction is executed ahead of rotation. When an embroidery pattern is so set to be rotated by 90° and then enlarged by 2 times in the X-axis direction, the X-axis enlargement is executed first and rotation by 90° is executed afterwards. Therefore, a pattern is enlarged by 2 times at the sewing point.

		Rotation of embroidery pattern (→ Page 79)
		Enlargement/reduction of embroidery pattern in the X-axis direction (→ Page 80)
		Enlargement/reduction of embroidery pattern in the Y-axis direction (→ Page 80)
		Mirror pattern (→ Page 82)
		Right/left mirror pattern
		Up/down mirror pattern
		Zero point symmetric mirror pattern
		No. of repetitions in the horizontal direction (lines) (→ Page 84)
		No. of repetitions in the vertical direction (rows) (→ Page 84)
		Distance in the horizontal direction between two outer hoop centers (→ Page 84)
		
		Distance in the vertical direction between two outer hoop centers (→ Page 84)
		
		Direction of repetitions (→ Page 84)
		Horizontal direction from upper left to lower right
		Vertical direction from upper right to lower left
		Horizontal direction from lower right to upper left
		Vertical direction from lower left to upper right
		Horizontal direction from upper right to lower left
		Vertical direction from upper left to lower right
		Horizontal direction from lower left to upper right
		Vertical direction from lower right to upper left
		0 stitch deletion (→ Page 86)
		Thread trimming feed number (→ Page 87)
		Swing width correction (→ Page 87)

Rotation

A pattern can be rotated.



- A maximum range of rotation is 1 ~ 359 degrees.
- The rotating direction is counterclockwise.
- Rotating angle can be set in either of the following.

By using ◀▶

Angle can be specified in increments of 90°. Setting of 90°, 180° or 270° is available.

By using ten keys

Angle can be specified in increments of one degree.

1. Read sewing data.
2. Press .
3. Press ◀▶ to select an angle or use ten keys to specify an angle.

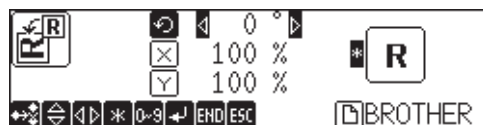

4. Press .

The initial screen is displayed again.

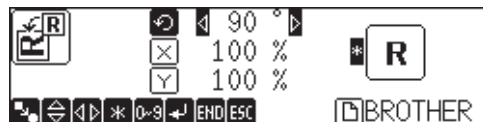

Enlargement and Reduction

A pattern can be enlarged or reduced.



- The enlargement and reduction ratio is 50 ~ 200%.
- The number of stitches does not change even by enlargement or reduction of a pattern. However, stitches may become too rough or close if enlargement or reduction is excessive.
- There are the following two types of enlargement/reduction.
 - Enlargement/reduction at the same ratio in both the X and Y directions
 - Enlargement/reduction at different ratios in the X and Y directions

1. Read sewing data.

2. Press .

Enlargement/reduction at the same ratio in the X/Y directions

3. Press .

  are reversed in black.

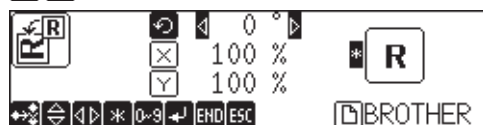

4. Input enlargement/reduction ratio by pressing ten keys.

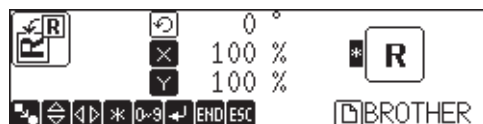

5. Press .

The initial screen is displayed again.

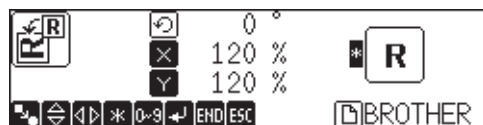

Enlargement/reduction at different ratios in the X/Y directions

3. Press ∇ twice.

\boxtimes is reversed in black.

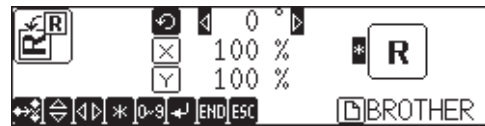

4. Input enlargement/reduction ratio in the X direction by pressing ten keys.

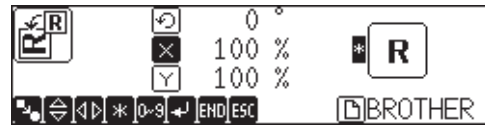

5. Press ∇ .

\boxdot is reversed in black.

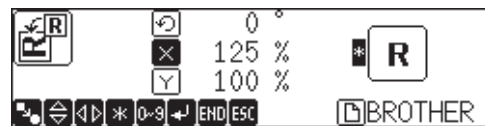

6. Input enlargement/reduction ratio in the Y direction by pressing ten keys.

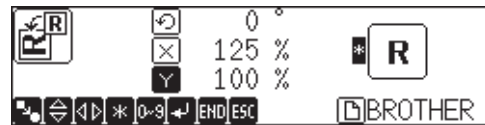

7. Press **END**.

The initial screen is displayed again.

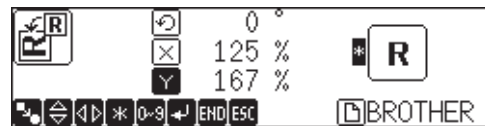

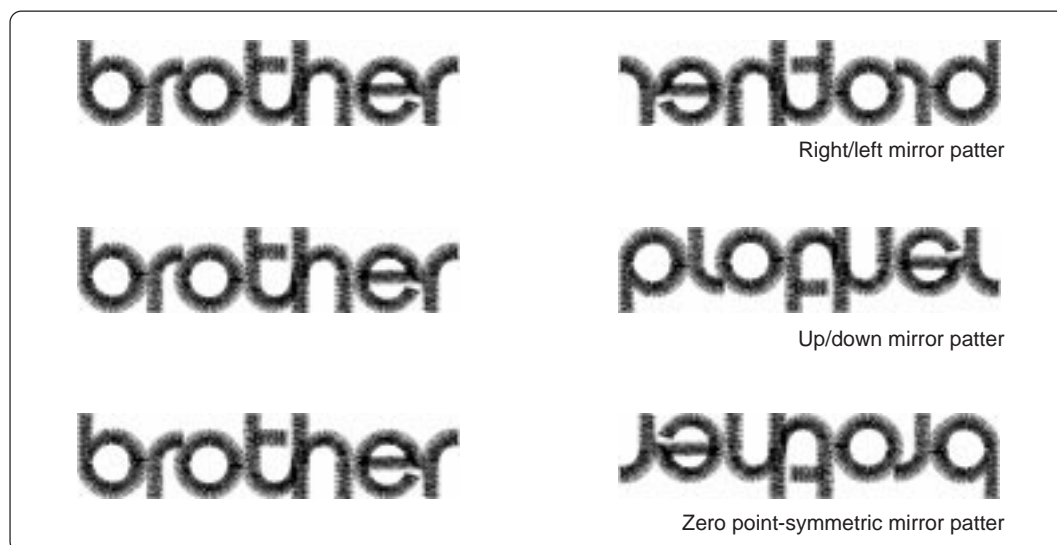

Mirror

A pattern can be reversed as if it is reflected in the mirror.



■ Up/down mirror pattern → Right/left mirror pattern → Zero point-symmetric mirror pattern.

	Right/left mirror pattern	The pattern is reversed in the right/left direction on the basis of the embroidering start point.
	Up/down mirror pattern	The pattern is reversed in the up/down direction on the basis of the embroidering start point.
	Zero point-symmetric mirror pattern	The pattern is reversed on the basis of the embroidering start point.

1. Sewing data is read.

2. Press  .

Right/Left Mirror Pattern

3. Keep pressing ***** until  is displayed.

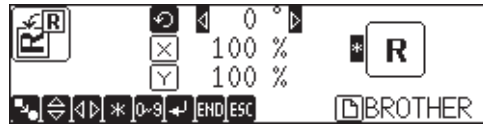

4. Press **END**.

The initial screen is displayed again.

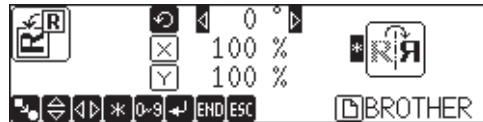

Up/Down Mirror Pattern

3. Keep pressing ***** until  is displayed.

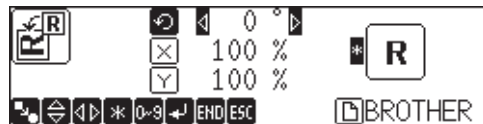

4. Press **END**.

The initial screen is displayed again.

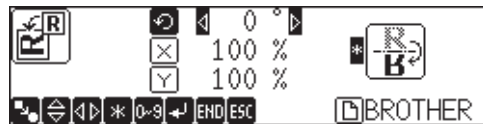

Zero Point-Symmetric Mirror Pattern

3. Keep pressing ***** until  is displayed.

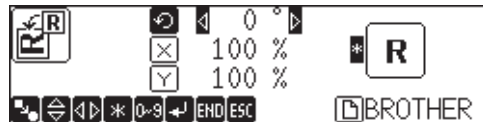

4. Press **END**.

The initial screen is displayed again.

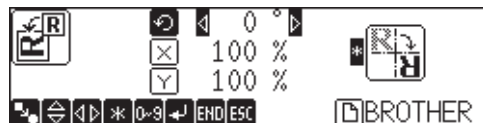

Repetition

A pattern is repeatedly copied as many times as specified.



- The number of repetitions is 1 ~ 99 in both the vertical (row) and horizontal (line) directions.
- There are the following eight directions of repetitions.

	Horizontal direction from upper left to lower right
	Vertical direction from upper right to lower left
	Horizontal direction from lower right to upper left
	Vertical direction from lower right to upper left
	Vertical direction from lower left to upper right
	Horizontal direction from upper right to lower left
	Vertical direction from upper left to lower right
	Horizontal direction from lower left to upper right

- There are the following two types of intervals between repetitions.

	By setting a distance between the outer hoops of each pattern
	By setting a distance between the centers of each pattern

1. Read sewing data.
2. Press twice.
3. Input the number of repetitions in the vertical and horizontal directions, by pressing ten keys.

The vertical and horizontal directions are changed over by pressing .

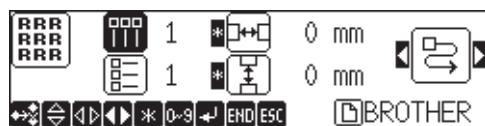

4. Press \triangleright .

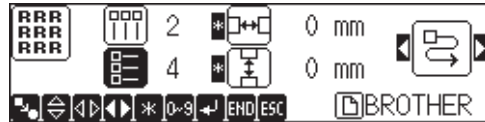

5. Input intervals between repetitions by pressing ten keys.

The vertical and horizontal directions are changed over by pressing \triangle / ∇ .

Press $*$ for setting a distance between the centers of each pattern.

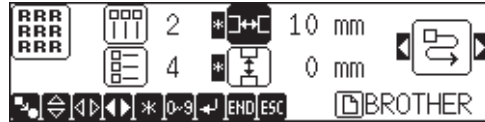

For setting a distance between the outer hoops of each pattern

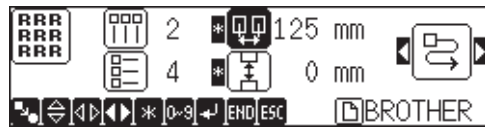

For setting a distance between the centers of each pattern

6. Select the direction of repetitions by pressing \blacktriangleleft / \blacktriangleright .

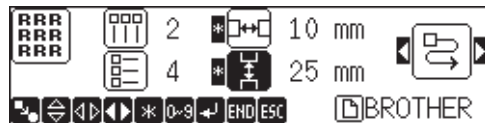

7. Press **END**.

The initial screen is displayed again.

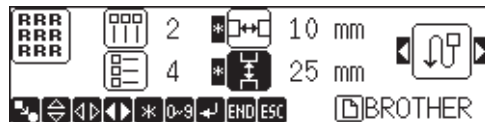

Other Editing

Setting of other functions related to editing is available.

The following types of setting is available.

0 stitch deletion	<p>For deleting stitches at the same point without stepping forward or back. This function is previously set to <input checked="" type="checkbox"/> (for not deleting 0stitch) upon shipment.</p> <p><input type="checkbox"/> For deleting 0 stitch <input checked="" type="checkbox"/> For not deleting 0 stitch</p>
Thread trimming feed number	<p>For setting the number of feeds for thread trimming This function is previously set to <input checked="" type="checkbox"/> (ECS data) or <input type="checkbox"/> (Except ECS data) upon shipment.</p> <p><input type="checkbox"/> For thread trimming at every 3 feeds <input type="checkbox"/> For thread trimming at every 5 feeds <input type="checkbox"/> For thread trimming at every 8 feeds <input checked="" type="checkbox"/> For not thread trimming</p>
Swing width correction	<p>For setting the needle swing width correction amount The correction amount can be set in increments of 0.1mm. The setting range is 0 ~ 1.0mm in both the X and Y directions. (The setting range is displayed as "0 ~ 10" on the screen.) Compensation is reflected only on the satin-stitched section. This function is previously set to 0(no swing width correction) upon shipment.</p>

1. Read sewing data.
2. Press  three times.

0 Stitch Deletion

3. Select this function by pressing .

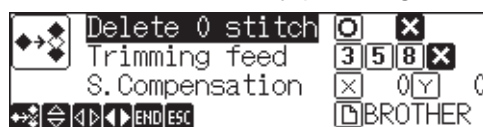

4. Press  after setting is finished.

Press  when setting continuously.

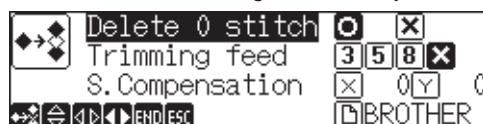

Thread Trimming Feed Number

3. Select this function by pressing $\triangle \nabla$.



4. Select the number of feeds by pressing $\triangle \triangleright$.

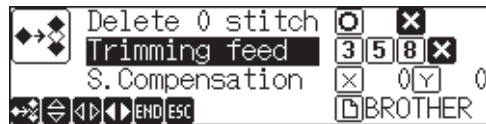

5. Press **END** after setting is finished.



Swing Width Correction

Correction values within 1 ~ 10 can be input. However, excessively large values may result in distortion of a pattern.

3. Select this function by pressing $\triangle \nabla$.

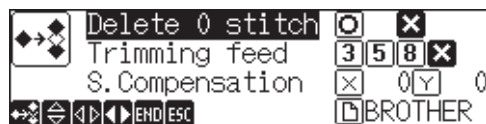

4. Select a correction amount in the X direction by pressing $\triangle \blacktriangleright$.

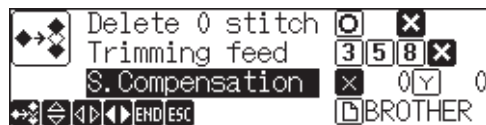

5. Reverse \blacktriangleright by pressing **Y**.

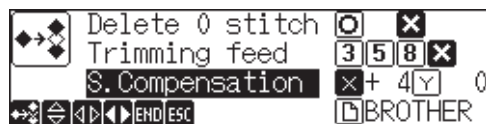

6. Input a correction amount in the Y direction by pressing $\triangle \blacktriangleright$.

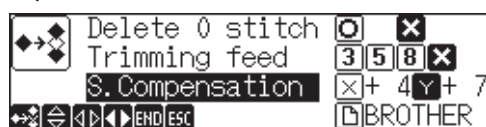

7. Press **END** after setting is finished.

Press Δ / ∇ when setting continuously.

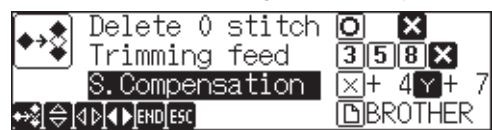



Chapter 5 Setting

This Chapter describes how to set a sewing speed, correct trouble including thread breakage and others related to machine motions.

What Can the Machine Do?

Setting of Needle Bars



Needle bars allocated in the sequence of embroidering (→ Page 92)

Setting of Thread Breakage Sensor



Thread breakage sensor ON/OFF (→ Page 93)



Thread breakage sensitivity (→ Page 93)



Number of stitches in automatic step back (→ Page 94)



Display of total stitch number in automatic step back



Lower thread counter counts (→ Page 95)



Stitch counter indication (→ Page 95)

Setting of Machine



Selection of embroidery hoop (→ Page 96)



Display of every head/every other head (→ Page 96)



Speed range (→ Page 97)



Speed in speed range (→ Page 98)



Thread trimming length (→ Page 101)



Thread removal feed length (→ Page 101)



Inching ON/OFF (→ Page 102)



Sewing area (→ Page 103)



Resetting of thread breakage error (→ Page 100)



Needle bar stop at mending stop point (→ Page 100)











Method of thread trimming before thread breakage error (→ Page 100)







Method of thread trimming before stop (→ Page 100)



Setting of Environment

		Return to start point after embroidering end (→ Page 106)
		Method of reflecting modified machine speed (→ Page 107)
		Power voltage (→ Page 107)
		Data transfer speed (→ Page 108)
		Display language (→ Page 109)
		Alarm sound (→ Page 110)
		Boring mode ON/OFF (→ Page 111)
		Data shift ON/OFF (→ Page 112)

Display of Information

		Display of pattern information (→ Page 113)
		Features of machine (→ Page 114)
		Version information (→ Page 115)

Hoop Retract Point

		Hoop retract point (→ Page 104)
		Automatic hoop retract ON/OFF (→ Page 105)

Hoop Movement

Registration of embroidering start point (→ Page 104)

Movement to registered sewing start point (→ Page 105)

Setting of Needle Bars

Needle bars allocated in the sequence of sewing can be modified.

- This setting is explained on the basis of the BES-1261BC screen.

1. Press .

2. Select a sewing sequence to modify by pressing  .

The current embroidering sequence is selected while embroidering is interrupted.

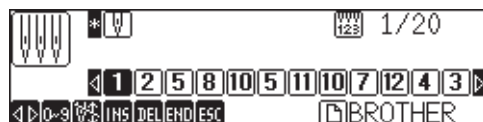

Press  for modifying all sequences at one time.





3. Input the number of a needle bar by pressing ten keys.

When inputting a numerical figure exceeding 10, press the  first.



Insertion of Feedhold

Press  and reverse the display on the right of a point to insert a feedhold, then press .

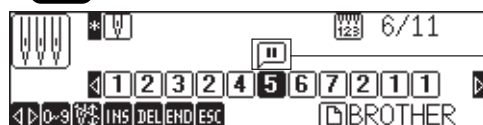

A feedhold mark is displayed.

4. Press .

Modified setting is saved and the previous screen is displayed again.

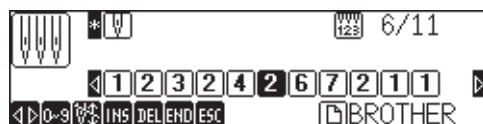

When all sequences are modified at the same time, the screen for checking if the setting needs to be saved. Press  for saving the setting.

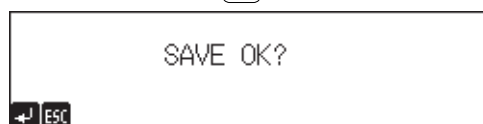

Thread Breakage Sensor

Validity or invalidity and sensitivity of the thread breakage sensor can be set.

Setting of sensor validity/invalidity

- This function is previously set to valid for all heads upon shipment.

1. Press .
2. Specify the number of a machine head by pressing ten keys and validate or invalidate the thread breakage sensor.

Pressing the same ten key once again changes between validity and invalidity.

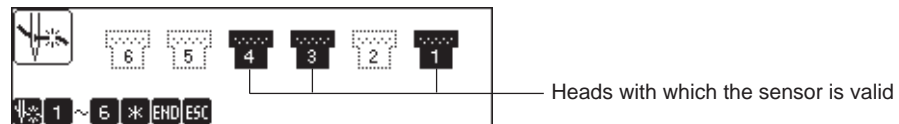

Press  to switch over the thread breakage sensor for each head between ON and OFF.





3. Press .

Modified setting is saved and the initial screen or halt screen is displayed again.

Thread Breakage Sensitivity

Sensitivity of the thread breakage sensor can be set.

- The sensitivity can be set within the range of 1 ~ 100. Sensitivity increases as the figure decreases.
- This function is previously set to 10 upon shipments.

1. Press  twice.
2. Select the needle bar for which the sensitivity is modified by pressing  .

The number of needle bars changes in the sequence of :
ALL (all needle bars) → 1 → 2 → ... 9 or 12 (max.) → ALL → ...



3. Select  by pressing  .

4. Input sensitivity of the thread breakage sensor.



5. Press **END**.

Modified setting is saved and the previous screen is displayed again.

Automatic Step-Back

The number of stitches to step back automatically in case of a thread breakage can be set.

- Setting can be done within the range of 0 ~ 10 stitches.
- This function is previously set to 0 stitches upon shipments.

1. Press  twice.

2. Select  by pressing .



3. Input the number of stitches to step back automatically by pressing ten keys. Pressing  sets whether to execute an extra step-back by a sensitivity amount of the thread breakage sensor in the automatic step-back mode.



Total number of stitches to step back in the automatic step-back mode

When stepping back by a sensitivity amount of the thread breakage sensor





When stepping back by preset number of stitches

4. Press **END**.

Modified setting is saved and the previous screen is displayed again.

Setting of Lower Thread Counter/Stitch Counter

- The lower thread counter reduces the indication each time one pattern is finished. After the reduction is finished, an error message can be displayed.
- The stitch counter increases the indication stitch by stitch.
- The lower thread counter can be validated or invalidated by pressing .
- The stitch counter can be cleared to zero by pressing .

1. Press  three times.
2. Input the number of counts of the lower thread counter by pressing ten keys.



3. Press  .
Modified setting is saved and the initial screen or halt screen is displayed again.



Setting of Machine

Machine motions can be set.



Embroidery Hoop

Specify a type of an embroidery hoop set on the machine.

- A type of a hoop to be selected varies depending on a type of a hoop (flat or cap) selected by a switch on the operation panel.

When a flat hoop is selected		Tabular square hoop
		Sash frame
		Flat hoop
When a cap hoop is selected		Cap hoop

- All heads or every other head can be selected by pressing  .

	All heads
	Every other head (The heads with odd numbers only are operated).

- When operating every other head, refer to "Bed Retract" (→ Page 45) and retract heads with even numbers.

1. Press  .

2. Select  by pressing  .

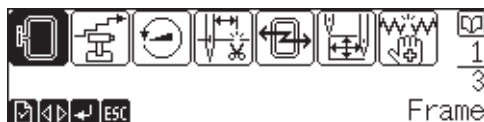

3. Press  .

4. Select a type of a hoop by pressing  .

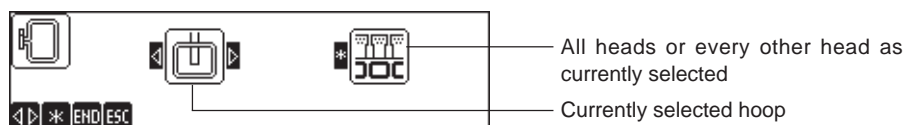

5. Select either all heads or every other head by pressing  .

6. Press  .

Modified setting is saved and the previous screen is displayed again.



Speed Range

A range of speed for each needle bar can be set.

■ This setting is explained on the basis of the BES-961 screen.

■ The speed range can be set within the range of 1 ~ 6.

1. Press .

2. Select  by pressing .

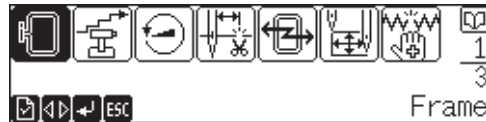

3. Press .

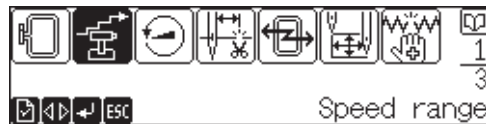

4. Select a needle bar by pressing .

When setting the same speed range for all needle bars, press .

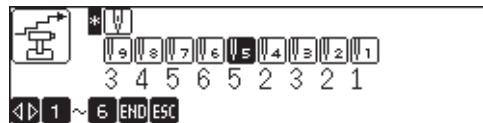



When modifying the speed range for one needle bar

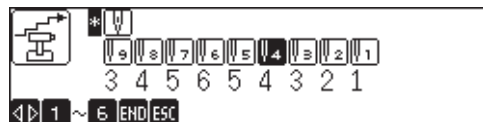

When modifying the speed range for all needle bars

5. Input a required speed range by pressing ten keys.



6. After modification is finished, press .

Modified setting is saved and the previous screen is displayed again.

Speed of Each Speed Range

Maximum speed of each range can be set.

- Speed can be input in increments of 10spm.
- The upper limit of a speed to be set varies depending on a selected hoop.

1. Press .

2. Select  by pressing .

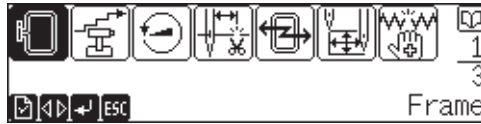

3. Press .

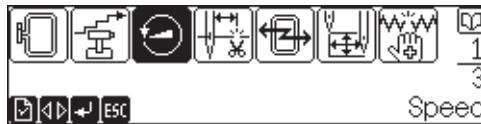

4. Select a speed range to modify by pressing .

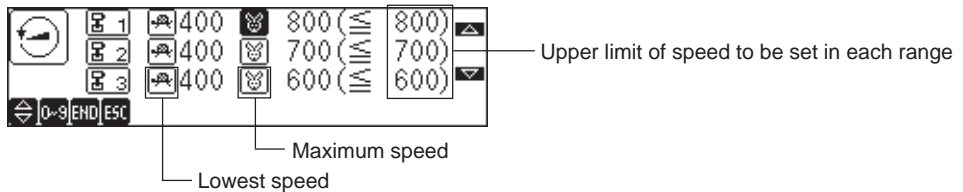

5. Input a required speed by pressing ten keys.



6. After modification is finished, press .













Modified setting is saved and the previous screen is displayed again.



Setting of Mending

Details of mending can be set in case of a thread breakage.

■ Contents of each setting item are as described below.

Item	Contents
	For setting a mending end point (number of stitches before a thread breakage) within the range of 1 ~ 10. This function is previously set to 5 stitches upon shipments.
	For setting whether to reset a thread breakage error automatically This function is previously set to  (Manual) upon shipments.
	 For resetting an error automatically
	 For resetting an error manually
	For setting whether to stop embroidering temporarily at the mending end point
	 For stopping embroidering at the mending end point
	 For stopping embroidering temporarily at the mending end point and then starting all heads automatically
	For setting a thread trimming method using the  immediately after resetting a thread breakage error. (This setting is effective only once after resetting the error.)
	 For trimming both upper and lower threads
	 For trimming the lower thread only
	 For not trimming any thread

■ Refer to "Mending" (→Page 121).

1. Press .

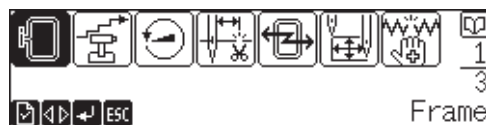

2. Select  by pressing .

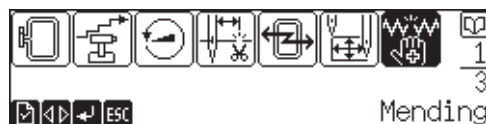

3. Press .





Setting of thread breakage error resetting method

- Select  by pressing .
- Press  for modifying a resetting method.



For setting whether to stop embroidering temporarily at the mending stop point

- Select  by pressing .
- Press  and select whether to stop embroidering temporarily.



Setting of thread trimming method after stopping

- Select a stop point (number of stitches before a thread breakage) by pressing ten keys.



Setting of mending stop position

- Select a stop point (number of stitches before mending) by pressing ten keys. The machine does not stop if the automatic step-back setting is lower than the input value.



After setting all items, press .

Modified setting is saved and the initial screen is displayed again.

Thread Trimming Length

Length of thread to leave on the needle bar after thread trimming can be set for each needle bar.

- This function is previously set to 5 upon shipments.

1. Press .

2. Select  by pressing .

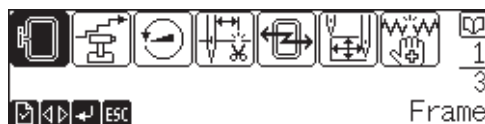

3. Press .

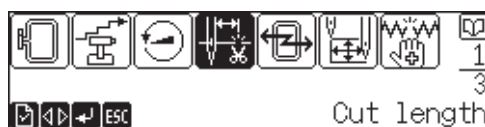

4. Select a needle bar to modify by pressing .

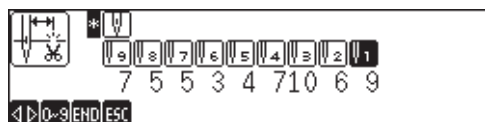

Press  for setting the same speed range for all needle bars.



5. Input thread length by pressing ten keys.

Thread length can be input within the range of 1 ~ 10. Length decreases as the figure decreases.

When inputting "10", press the  first.

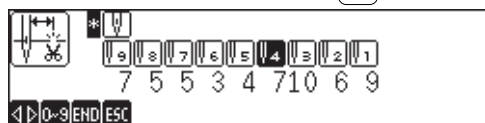

6. After setting is finished with all needle bars, press .

Modified setting is saved and the previous screen is displayed again.

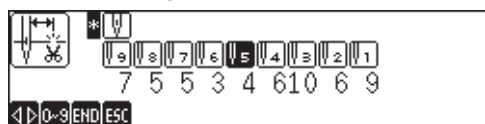

Thread Withdrawal Feed Length

Thread withdrawal length can be set before thread trimming.

- The input range is 0 ~ 100mm.
- This function is previously set to 15mm upon shipments.

1. Press .

2. Select  by pressing .

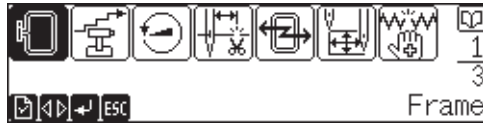

3. Press .

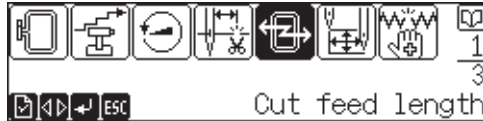

4. Input thread withdrawal length by pressing ten keys.

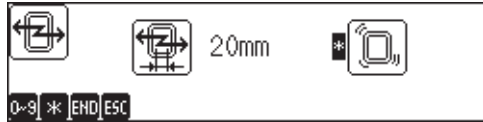

5. Press .

Modified setting is saved and the previous screen is displayed again.

Inching

Whether to select the inching mode for thread trimming can be set.

■ This function is previously set to selected upon shipments.

1. Press .

2. Select  by pressing .

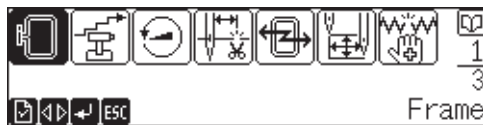

3. Press .

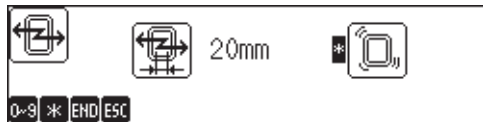

4. Set whether to select the inching mode by pressing .



5. Press .

Modified setting is saved and the previous screen is displayed again.

Sewing Area

An allowable area for sewing can be set.

- Pressing  moves the hoop to the currently selected coordinates.
- A maximum sewing area during operation of every other machine heads is as shown below.

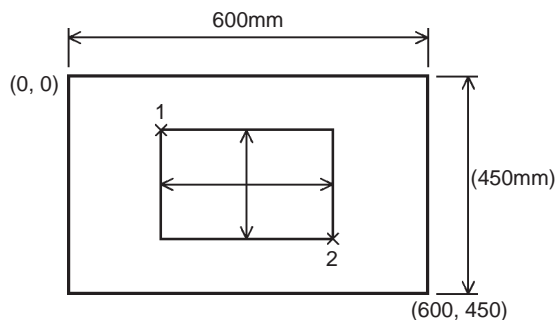

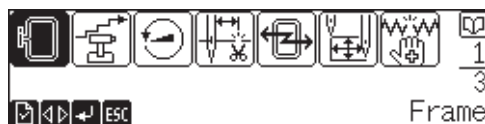

1. Press .

2. Select  by pressing .

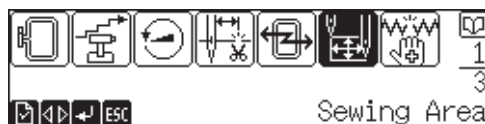

3. Press .



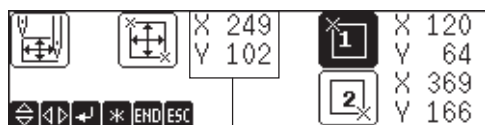

4. Specify coordinates of the upper left of the sewing area. Move the hoop by pressing  .



Indicates a currently set embroidery area

5. Press .

Pressing  set a maximum area designated for a currently set hoop.



6. Specify coordinates of the lower right of the sewing area. Move the hoop by pressing  .

7. Press .

Pressing  restores a status before modification of setting.

Registration of Sewing Start Position

Register a position to start sewing.

- When returning to a registered sewing start position, hold down  and press .

- Press the  key.

The hoop coordinates are displayed.



- Shift the hoop to a position to start sewing by pressing the .

- Press .



- Press the  key.

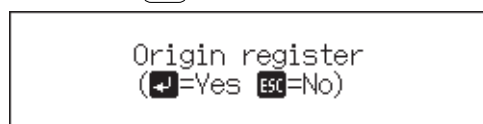

Hoop Retract Point

The hoop basic point (retract point) can be set when sewing is interrupted.

- When restarting sewing after the hoop is retracted during an interrupt, press .

- Press .

- Move the hoop by pressing .

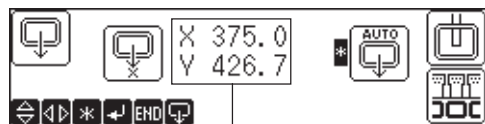

Current hoop coordinates

- Press .

Modified setting is saved and the initial screen or halt screen is displayed again.
The hoop returns to the initial point.

Cancellation of Setting

- Press  once again.

Modified setting is canceled and the initial screen or halt screen is displayed again. The hoop returns to the initial point.

Hoop Automatic Retract

Set whether to move the hoop automatically to the retract point at the end of sewing.

- This function is previously set to no hoop automatic retract upon shipments.

1. Press .

2. Select whether to retract the hoop automatically by pressing .

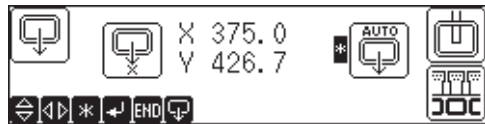

For automatically retracting the hoop

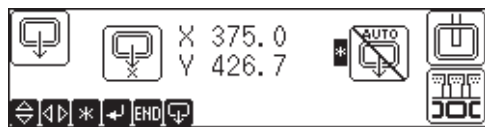

For not retracting the hoop automatically

3. Press .

Modified setting is saved and the initial screen or halt screen is displayed again.

Movement to Registered Sewing Start Point

This operation should be done before starting sewing.

1. Hold down  and press .

2. The hoop moves and the zero point is detected. Then the hoop moves to a registered start point.

Moving frame



Detecting home position...



Return to origin point

3. The initial screen is displayed again.

Setting of Environment

Return to Start Point

Whether to return to the start point after sewing is finished can be set.

1. Press  twice.

2. Select  by pressing .



3. Press .

4. Select  by pressing .

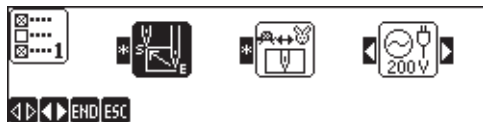

5. Select whether to validate a return to the start point by pressing .

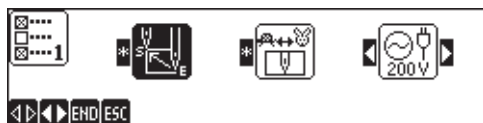

When the start point return is valid

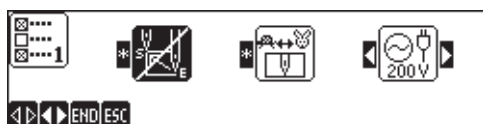

When the start point return is invalid

6. Press .

Modified setting is saved and the previous screen is displayed again.

Speed Range

For setting whether to reflect modified machine speed to all needle bars.

1. Press  twice.

2. Select  by pressing .



3. Press .

4. Select  by pressing .



5. Modify setting by pressing .

Press  for invalidating the modification.



6. Press .

Modified setting is saved and the previous screen is displayed again.

Power Voltage

Voltage of power supplied to the machine can be specified.

- Available voltage is 200V, 220V, 230V and 240V.

Item	Contents
	200V
	220V
	230V
	240V

1. Press  twice.

2. Select  by pressing .



3. Press .

4. Select voltage by pressing .



5. Press .

Modified setting is saved and the previous screen is displayed again.

Setting of RS-232C Communication Speed

Speed for transferring embroidery data between the operation panel and a personal computer with BE-100 installed.

■ The transmission speed can be selected within the range of 9600, 19200, 38400 and 115200. (unit : bps)

1. Press  twice.

2. Select  by pressing .



3. Press .



4. Select [RS Speed] by pressing .



5. Select communication speed by pressing .

6. Press .

Modified setting is saved and the previous screen is displayed again.



Display Language

A language to display on the screen can be set.

- The following languages can be selected.

Display	Contents
JPN	Japanese
Eng	English
Españl	Spanish

1. Press  twice.

2. Select  by pressing .



3. Press .



4. Select [Language] by pressing .



5. Select a language to display by pressing .



6. Press .

The previous screen is displayed again with a display in a selected language.

Alarm Sound

Whether to generate a sound in case of an error can be set.

■ The following sounds can be set.

ON	A sound is generated until the error is reset.
OFF	A sound is generated twice.
5	A sound is generated five times.

1. Press  twice.

2. Select  by pressing .



3. Press .



4. Select [Beep] by pressing .



5. Select a kind of sound by pressing .

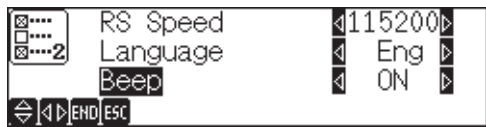

6. Press .

Modified setting is saved and the previous screen is displayed again.

Boring

Whether to validate or invalidate the boring mode and to shift data in case of boring can be set.

- This setting is available only for sewing data which has been created for boring.
- The machine itself cannot check if the sewing data is for boring or not. Therefore, make sure to check the data before starting sewing.
- Mount the following optional accessories on the machine before starting sewing.
 - Boring knife
 - Needle plate for boring
- If editing including enlargement, reduction or rotation is done using sewing data created for boring, the correct sewing may not be available.
- This function is previously set to :
 - Boring mode valid/invalid : invalid
 - Data shift valid/invalid : invalid

Validation/Invalidation of Boring Mode

1. Press  twice.

2. Select  by pressing .



3. Press .



4. Select  by pressing .



- Validate or invalidate the boring mode by pressing *****.



When the boring mode is valid



When the boring mode is invalid

Validation/Invalidation of Data Shift

- Press **[Data Shift]** twice.
- Select **[Data Shift]** by pressing **<>**.



- Press **[Enter]**.



- Select **[Data Shift]** by pressing **<>**.



- Validate or invalidate the data shift by pressing *****.



When the data shift is valid

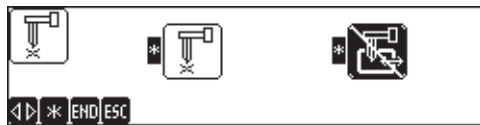

When the data shift is invalid

- Press **END**.
Modified setting is saved and the previous screen is displayed again.







Display of Information

Information about the machine and patterns can be displayed on the screen.

Pattern Information

Detailed information about a selected pattern can be checked.

■ Contents of information to be displayed are as shown below.

	Size of sewing data (mm)
	Coordinates of embroidering start point
	Coordinates of embroidering end point
	Number of stitches
	Number of colors
	Name of data

1. Press  three times.

2. Select  by pressing .



3. Press .

4. Check information about patterns.

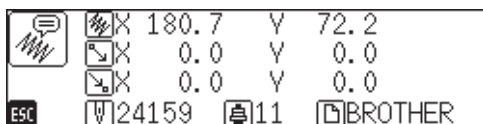





5. Press .

The previous screen is displayed again.

Features of Machine

Detailed information of the machine can be checked.

■ Contents of information to be displayed are as shown below.

	Maximum moving range of flat hoop (for all heads)
	Maximum moving range of flat hoop (for every other head)
	Maximum moving range of cap hoop
	Number of heads
	Number of needle bars per head

1. Press  three times.

2. Select  by pressing  .

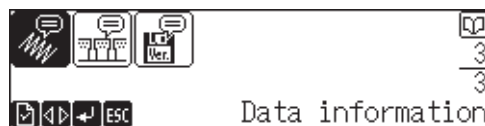

3. Press .

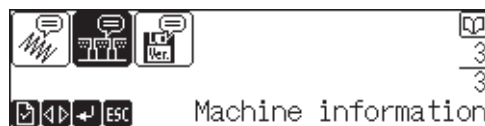

4. Check information about the machine.

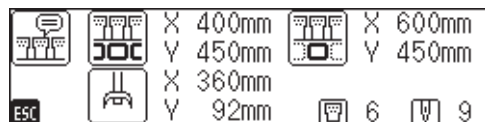





5. Press .

The previous screen is displayed again.

Information about Versions

Information about CPU ROM version, etc. can be checked.

■ Contents of information to be displayed are as shown below.

	Operation panel version
	Main CPU ROM version
	Upper axis CPU ROM version
	Lower axis CPU ROM version
	Interface CPU ROM version

1. Press  three times.

2. Select  by pressing .



3. Press .



4. Check information about versions.

The version is displayed by the combination of alphabets (A ~ Z) and numerical figures (1 ~ 9).

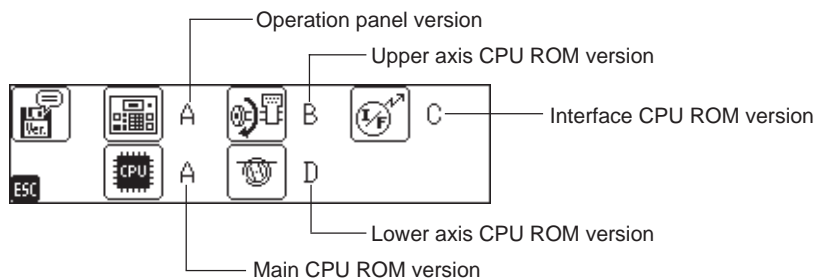

5. Press .

The previous screen is displayed again.



Chapter 6 Operation of Machine

1. Operating Procedures

1-1 Power Source

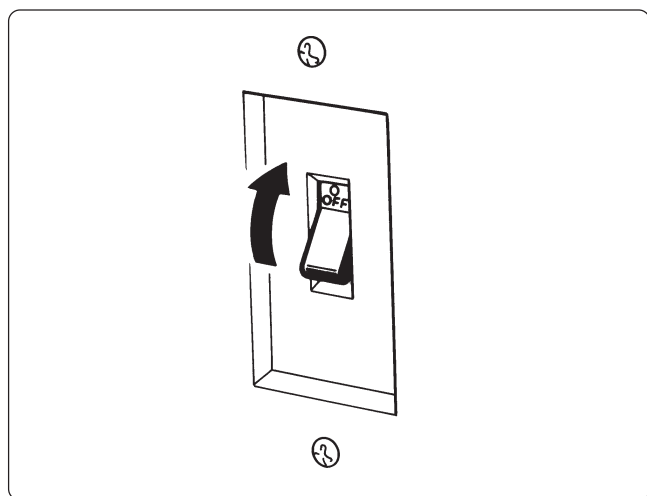

- Turn the power on to the machine.
- A message is displayed on the LCD.



- The alarm sounds three times and the needle bar and the presser foot move upward. Then the hoop moves to the zero point and the sewing data screen is displayed.

Note) When turning the power off and back it on again, wait for at least 10 seconds.

1-2 Preparation for Embroidering

- Select embroidering data.
- Using the jog switches ($\triangle \nabla \triangleleft \triangleright$), determine a position to start embroidering.
Note) An error message is displayed on the LCD if a pattern comes out of the hoop.
- Pressing  starts embroidering.
- After embroidering is finished, the machine is placed in the stand-by state.

2. Machine Stop

2-1. Stopping of Machine

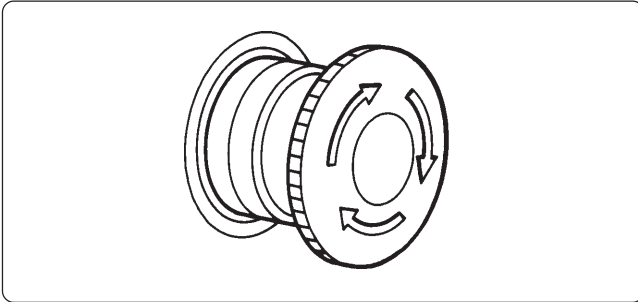

Press the emergency stop switch or to  the machine.

2-2. Resetting Emergency Stop

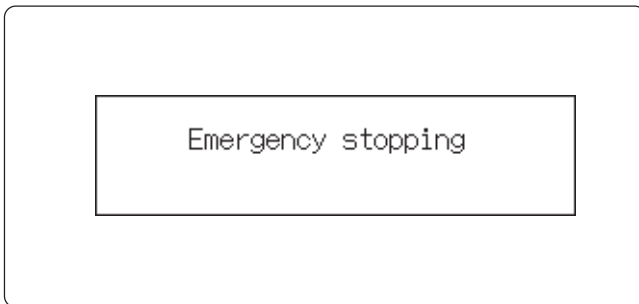

- When either emergency stop button is depressed, "Emergency stopping" is displayed on the operation panel.
- For resetting the emergency stop button, turn the button in the direction of the arrow. The button pops up and is reset.

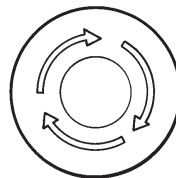

- Check that both emergency stop buttons on the right and left are reset.

3. Measures against Thread Breakage

3-1 Remedies

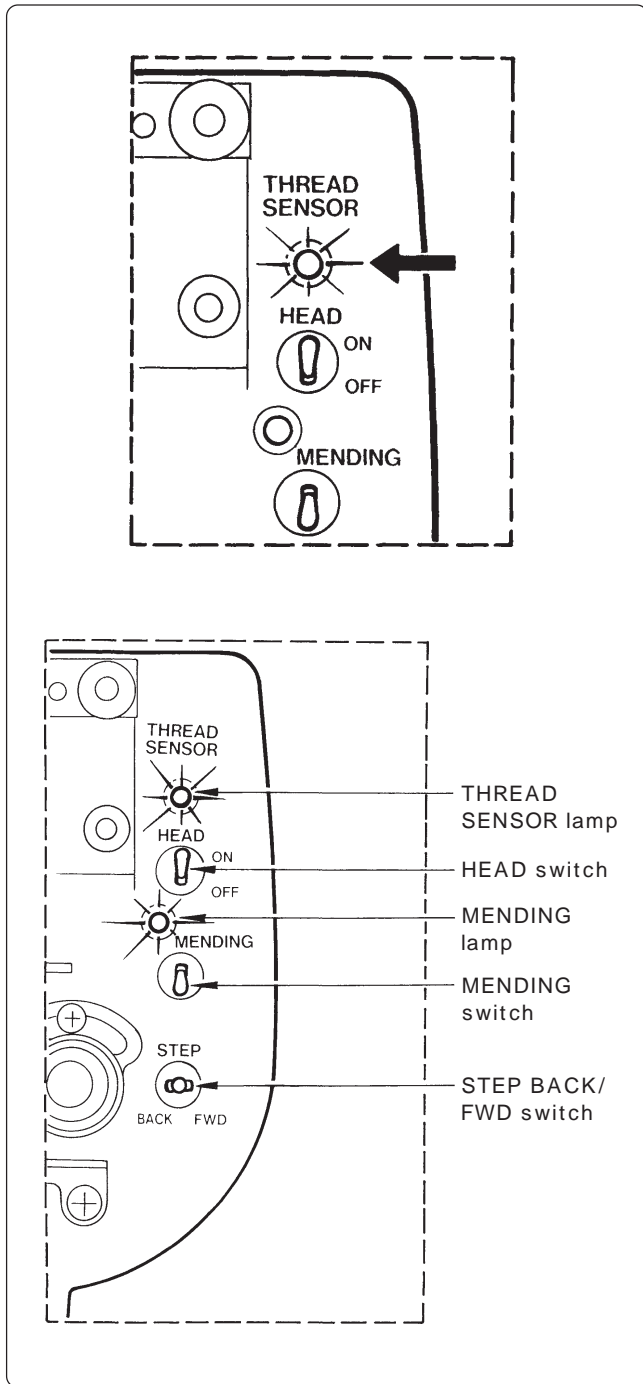

1. If embroidering is suspended due to thread breakage, the THREAD SENSOR lamp of the machine head with a thread breakage blinks.

2. Correct the broken thread and pass it through again.

* Refer to "Chapter 1, 4-1 Upper Threading" (→ Page 34) for details.

3. Press the STOP switch or press the STEP BACK/FWD switch in order to reset the alarm.



4. Return the hoop to a position where thread breakage occurred by pressing the STEP BACK switch.

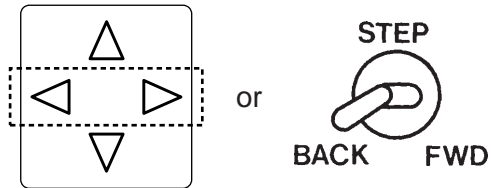

Note) When the switch is turned for 20 stitches or more, the machine continues operation without holding the switch. To stop the machine, turn the switch to the opposite side.

5. Press the START switch on the operation panel or the start switch located between the machine heads to resume operation.

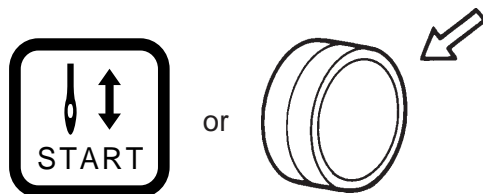

3-2 Mending

The machine head whose MENDING lamp is lit performs embroidering by the preset number stitches. When it is completed, all the machine heads start normal embroidering operation.

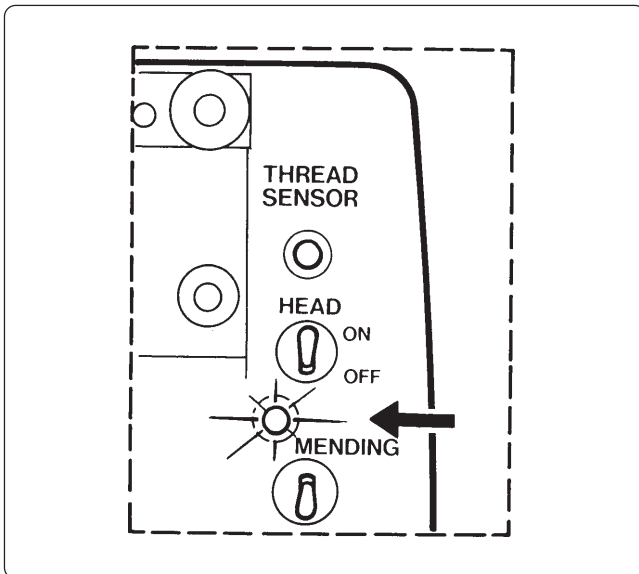

- The MENDING lamps except for the machine head whose needle thread has been broken are turned off.
- At this time, the machine head, whose MENDING lamp is on, performs resewing from the step-back position while the other machine heads (with MENDING lamps off) are stopped. When resewing is completed, the other machine heads (except those halted or with bed retracted) also start embroidering.

■ Manual operation

The mending start and end positions can be set for each machine head using the MENDING switch on the tension plate.

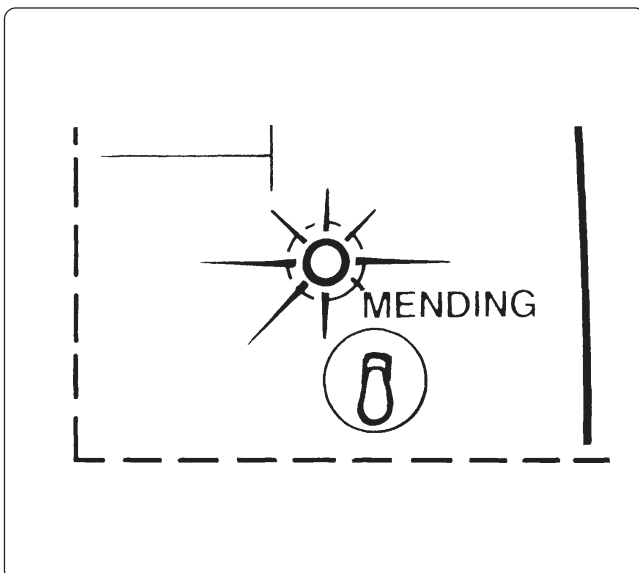

The MENDING lamp is lit when the MENDING switch of each machine head is flipped up during standby. Resewing from the step-back position to this position can be executed.

- * When the MENDING switch is flipped up while the MENDING lamp is off, the lamp is turned on; when the MENDING switch is flipped up again while the MENDING lamp is lit, the lamp is turned off.

Note) The mending end position cannot be set for each machine head.

When all MENDING lamps are turned on, the mending end position will be set to the position where one of the lamps is turned off first.

Note) To cancel the mending end position, turn all the MENDING lamps are turned on (except for halted machine heads) .

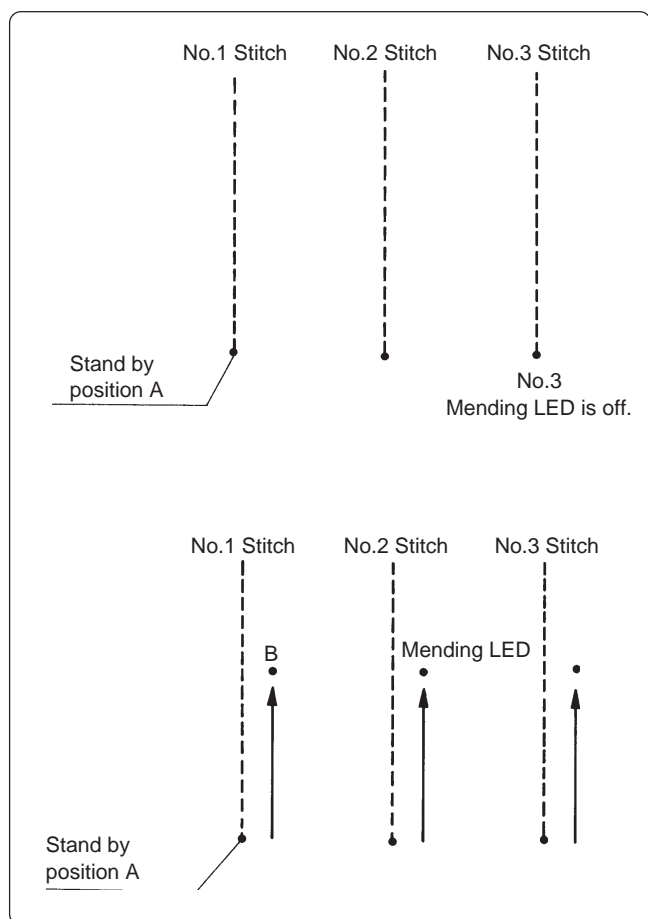

1. Turn off the MENDING lamp No. 3 at the standby position A.
 (The position A should be the mending end position.)

2. Press the jog ◀ switch or  to move it backward.
 Turn off the MENDING lamp No. 2 at the position B.
 (The position B does not become the end position; the position A remains the end position.)

Note) When the MENDING switch of the machine head whose lamp is off is pressed:

- The MENDING lamp of the machine head is lit, and mending is executed for the machine head.

Note) When the MENDING switch of the machine head whose lamp is on is pressed:

- The MENDING lamp of the machine head goes off and mending is not executed for the machine head.

When a thread breakage error is occurring, refer to "Setting of Mending" (→Page 99) as well in order to correct missing stitches caused by a thread breakage.

4. Jog Embroidering

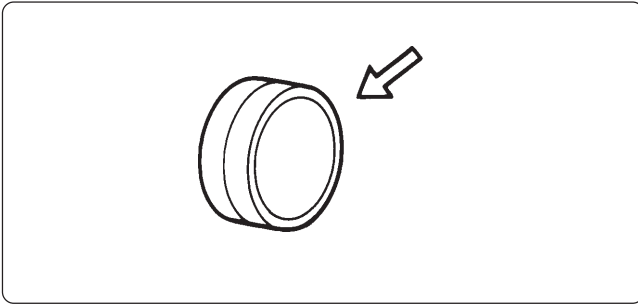

- Jog embroidery can be used for preventing the thread from slipping from the needle at the start of embroidering.
- Jog embroidery can be executed as long as the start switch at the machine head is held down.

Note) Never apply a tape on the switch to keep jog operation for a long time. Doing so may cause damage to the machine.

5. Hoop Feed Position

- In order to ease mounting and dismounting of the embroidery hoop, another needle position can be set as a hoop feed position in the movable area additionally to the current needle position.
- In order to ease material attachment while operation is suspended, the hoop can be moved to the feed position at any time by the hoop feed switch.
- The hoop can also be moved to the feed position automatically after embroidering is finished. Refer to "Hoop Automatic Retract" on Page 105 for details.



6. Area Check

6-1 External Tracing

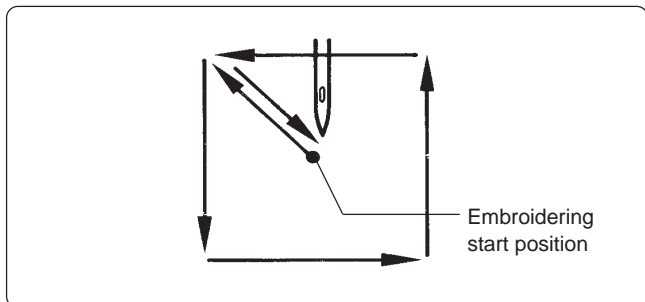

- If the check switch is pressed in other cases than "area over", the rectangular outline of the pattern is traced.



6-2 Automatic Hoop Movement in Area

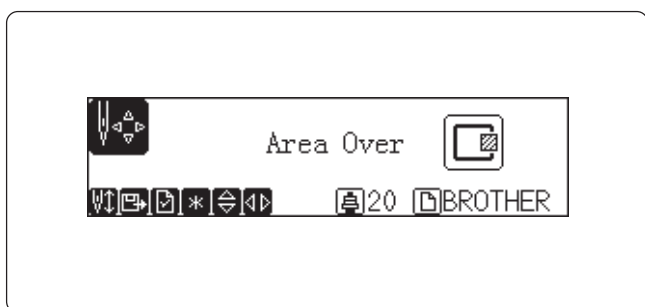
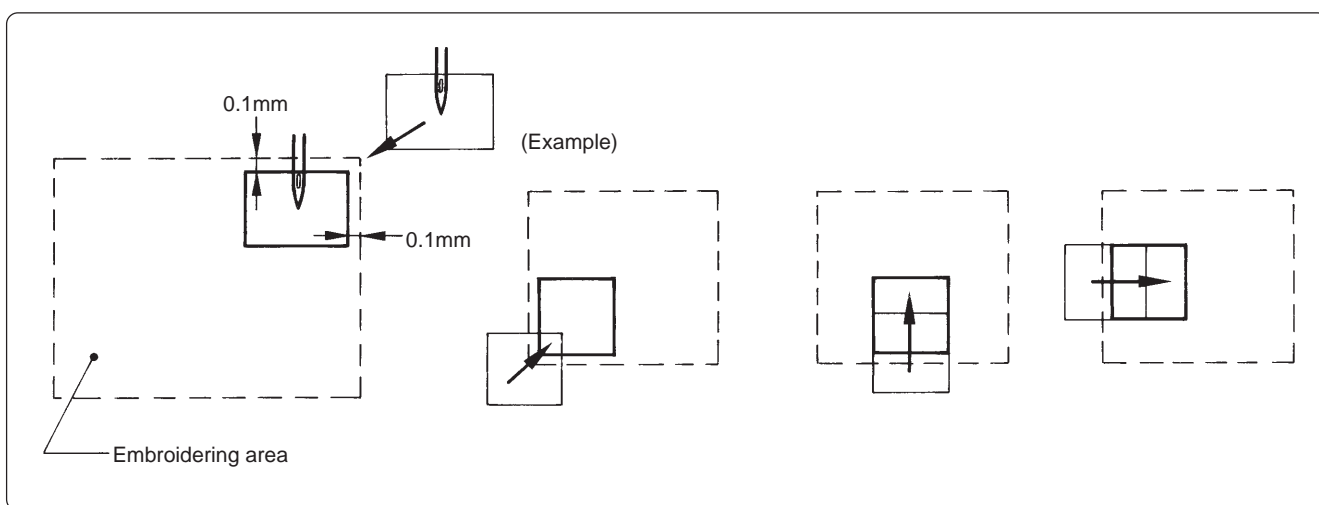

- If "area over" is displayed, press the check switch. The hoop automatically moves inside the embroidering area, where the pattern is set, at the nearest position.



Note) After finishing the movement inside the area by this function, execute external tracing. Then, check that the needle and the presser foot do not interfere with the hoop before starting embroidering.

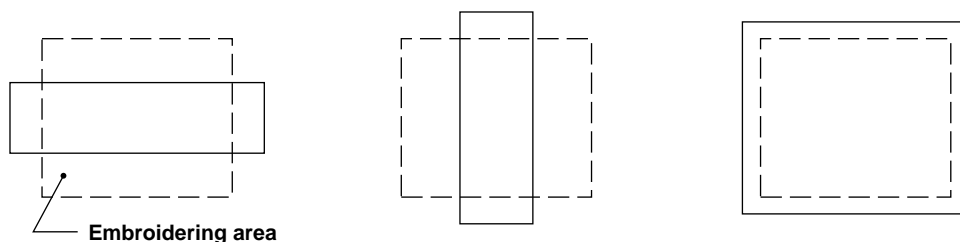

If the pattern is not held in the embroidering area as shown below, the hoop cannot move into the area. Enlarge the embroidering area on the operation panel.

7. Jog Switches

7-1 Hoop Movement to Start Position

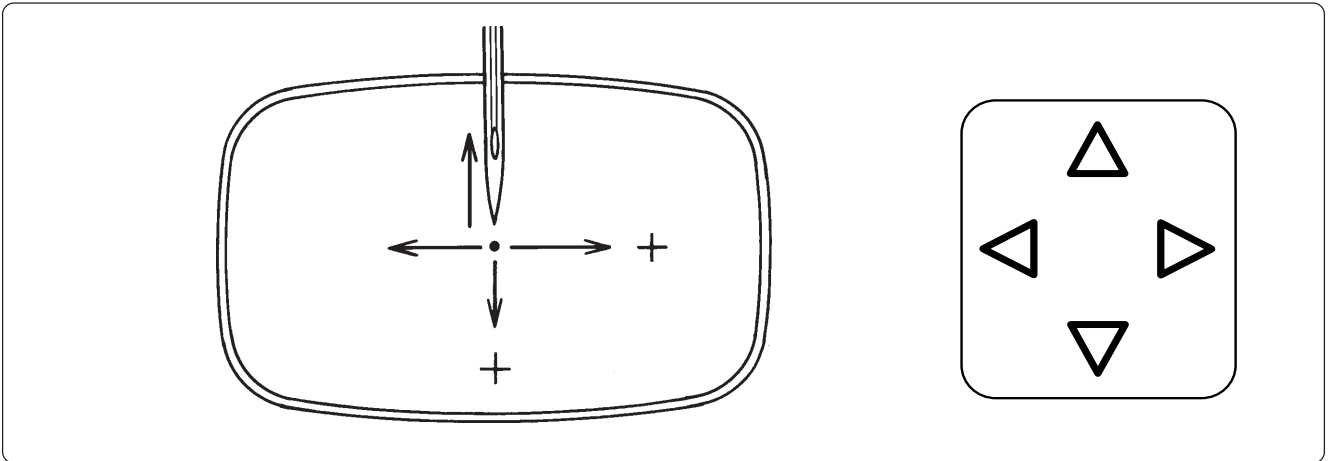

The hoop immediately after the embroidering mode becomes valid can be moved so that the start position can be set as required.

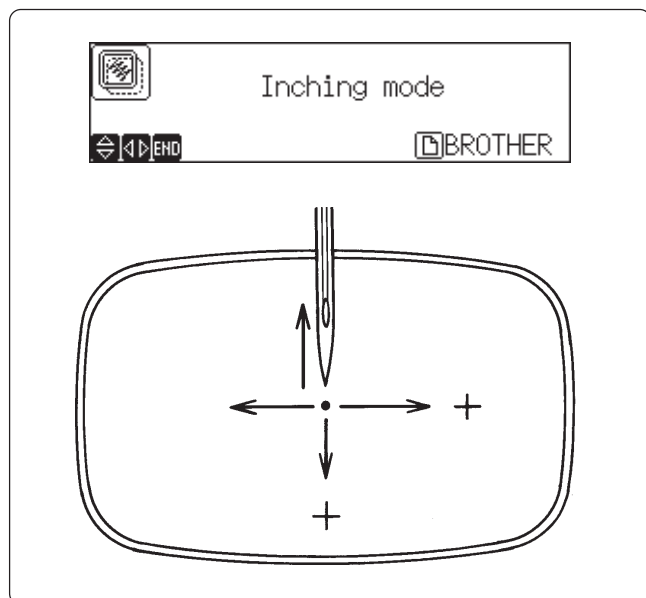

7-2 Inching Mode during Embroidering (Forcible Hoop Movement)

- Note)
- Moving the frame greatly in the inching mode may cause an interference with the machine. Pay utmost care in the inching mode.
 - The frame movement in inching mode is cleared when the power is turned OFF; therefore, if the power is turned ON again and sewing is started, the pattern may be embroidered in a different position. Be sure to use the inching mode appropriately.



1. Press the  while pressing the  switch in order to select the inching mode.
2. Press the jog switch and the hoop moves to the direction of the pressed switch.

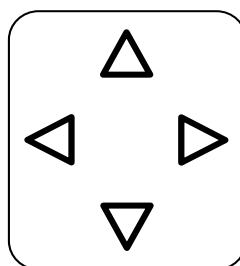

- Note)
- Note that the forcible hoop movement will produce deviation of embroidering by the amount.
 - If the hoop and material are deviated from each other during embroidering, correct it by using the jog switches.

3. Pressing the "END" switch resets the inching mode.



4. Press the "START" switch restarts embroidering.



8. Detection of Zero Point

After the zero point is detected, the hoop returns to the initial point

1. Before starting sewing, press  while pressing  when the initial screen is displayed.

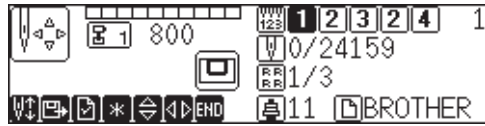

Initial screen

2. The hoop moves and the zero point is detected.

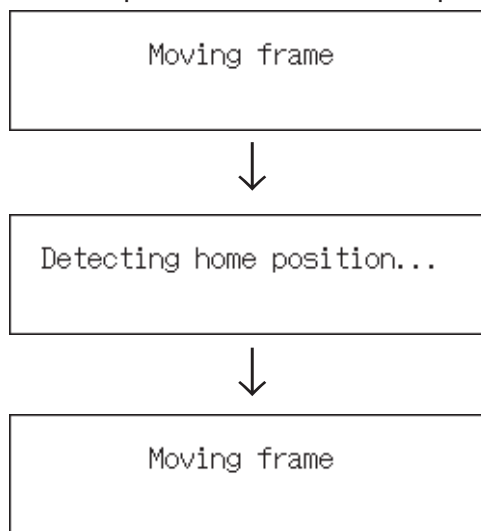



3. The initial screen is displayed again.



Chapter 7 Maintenance

CAUTION

-  Turn off the power switch before starting maintenance.
Failure to do so may start the machine unintentionally through an accidental activation of the START switch, resulting in bodily injuries.
-  Be sure to wear protective goggles and gloves when handling the lubricating oil or grease, so that no oil or grease gets into your eyes or onto your skin, otherwise inflammation can result.
Furthermore, do not drink the oil or grease under any circumstances, as they can cause vomiting and diarrhoea.
Keep the oil out of the reach of children.

- Keep the machine clean at all times to prevent machine trouble.
- Keep the machine clean.
Remove dirt with a soft, dry cloth. If necessary, clean with the detergent-soaked cloth, then wipe off the detergent with a cloth dampened with (hot) water.
- Caution
Never use benzene or thinner for cleaning the machine.

1. Cleaning Rotary Hook

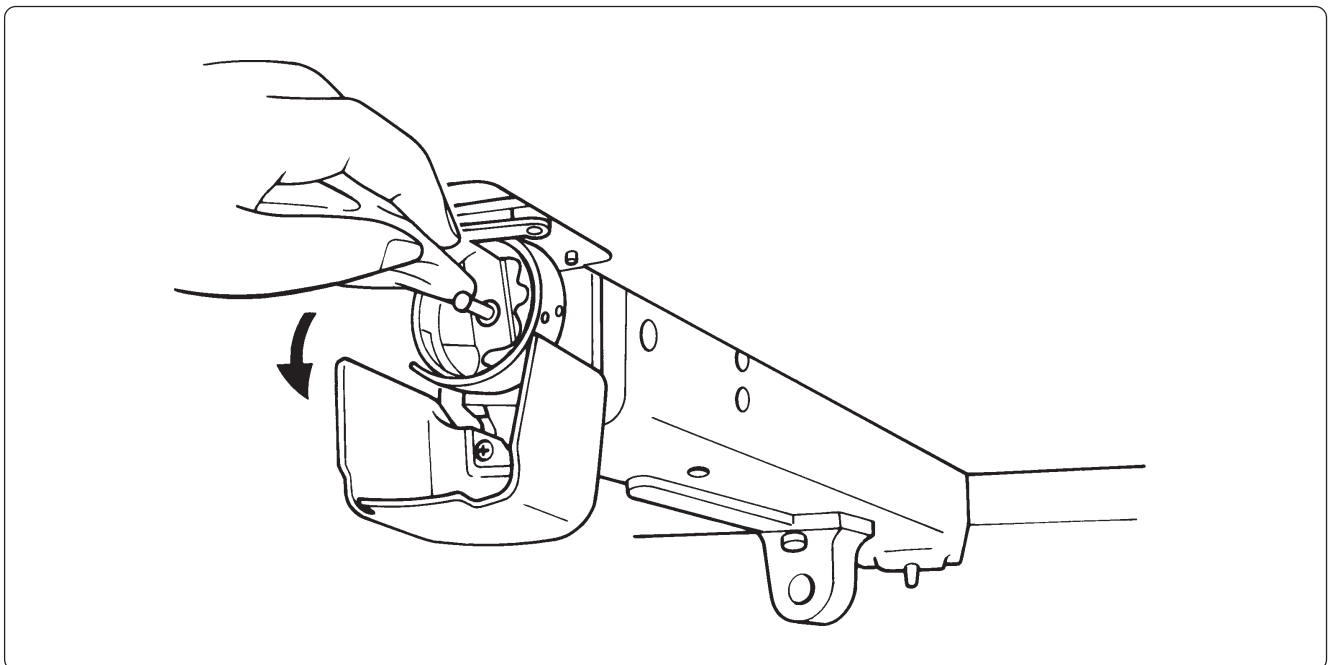

2. Oiling

To extend the machine's service life, supply oil to the following places at regular intervals.

- (Note)
- When oiling, be sure to supply Brother's machine oil (Nisseki Sewing Lube #10 or the equivalent) using the dropper.
 - Excessive oiling may cause the material to be stained.

2-1 Head

■ BES-961BC

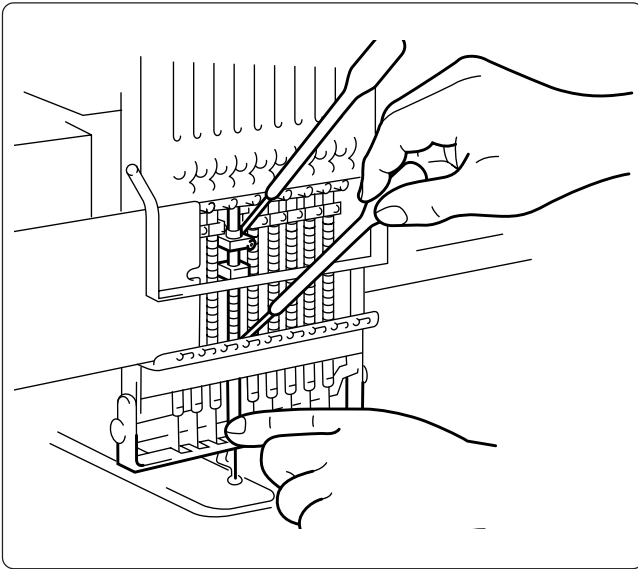

- Supply oil to the needle bars (18 positions) once a day as shown on the left.

■ BES-1261BC

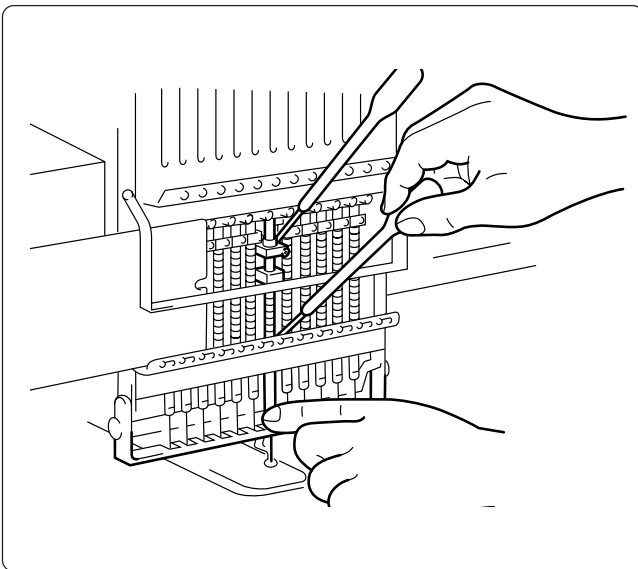

- Supply oil to the needle bars (24 positions) once a day as shown on the left.

■ BES-961BC

Lubricate the following part indicated by the arrow ("clearance" between the connecting rod and the needle thread take-up bearing) once a week.

(Note) • In lubrication, select needle bar 9 and remove arm cover L to check the lubrication area. Be sure to wipe off excessive oil spilt at the lower part of the arm.

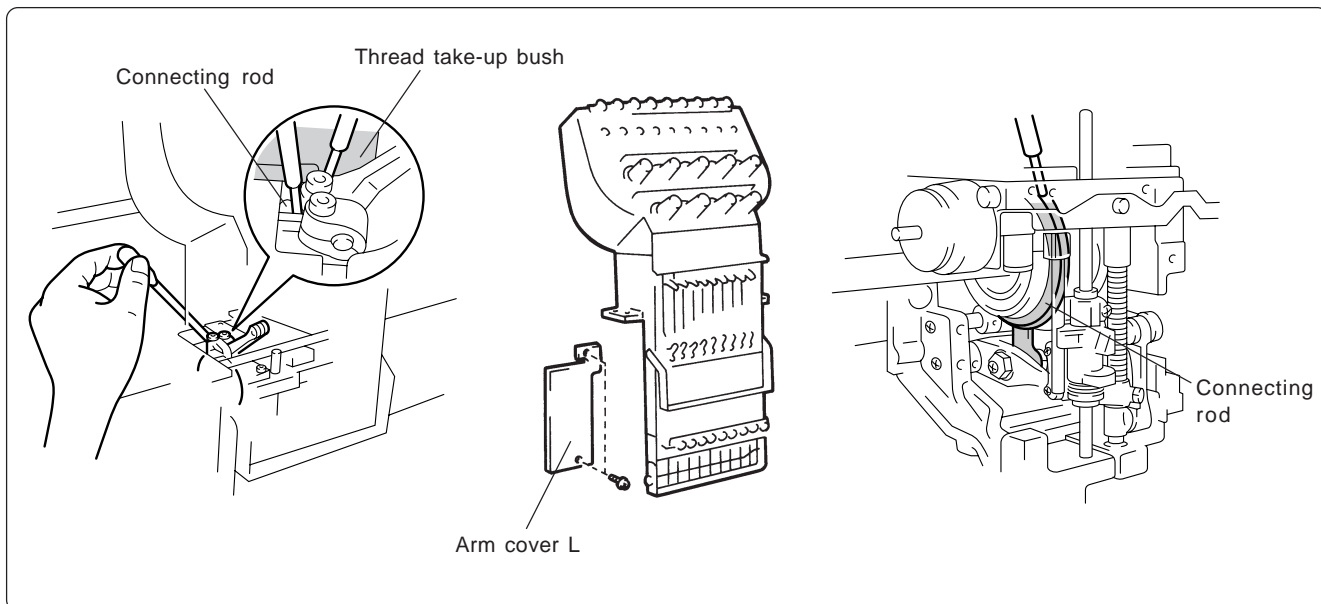

■ BES-1261BC

Lubricate the following part indicated by the arrow ("clearance" between the connecting rod and the needle thread take-up bearing) once a week.

(Note) • In lubrication, select needle bar 12 and remove the head cover to check the lubrication area. Be sure to wipe off excessive oil spilt at the lower part of the arm.

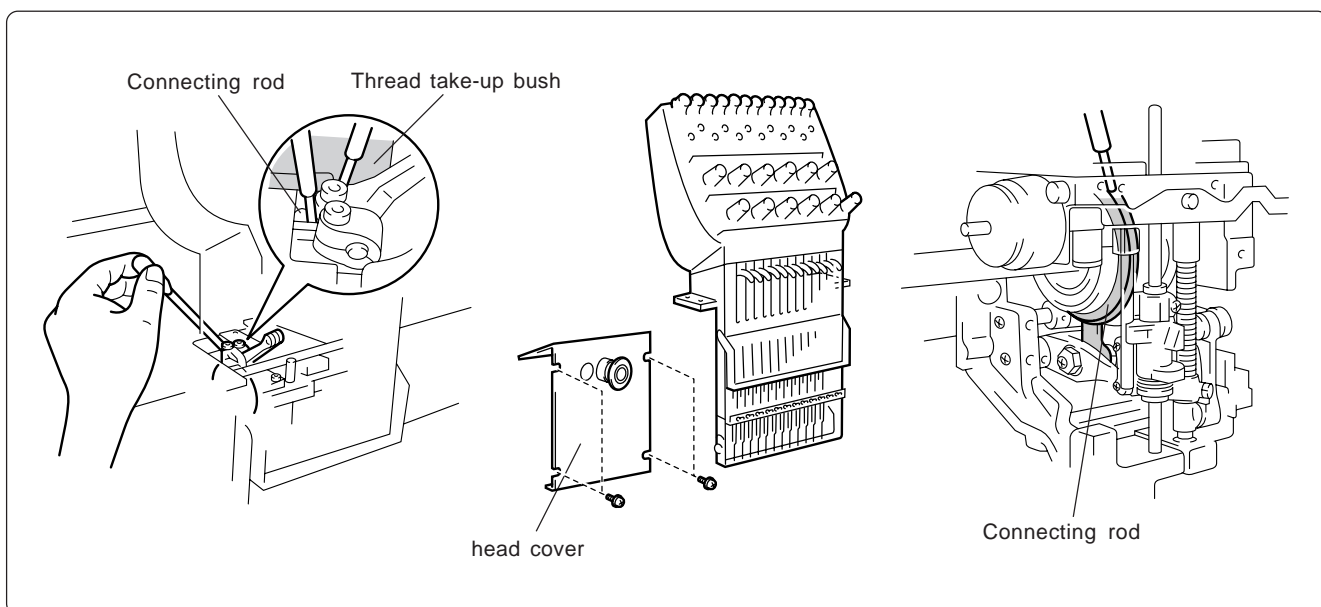

3. Greasing

To extend the machine's service life, supply grease to the following places at regular intervals.

(Note) • When greasing, be sure to use the grease tank BR2 (black) provided with the machine.

- For overhauling, contact your distributor or refer it to trained experts.

3-1 Head

■ Grease two places indicated by the arrow once a month.

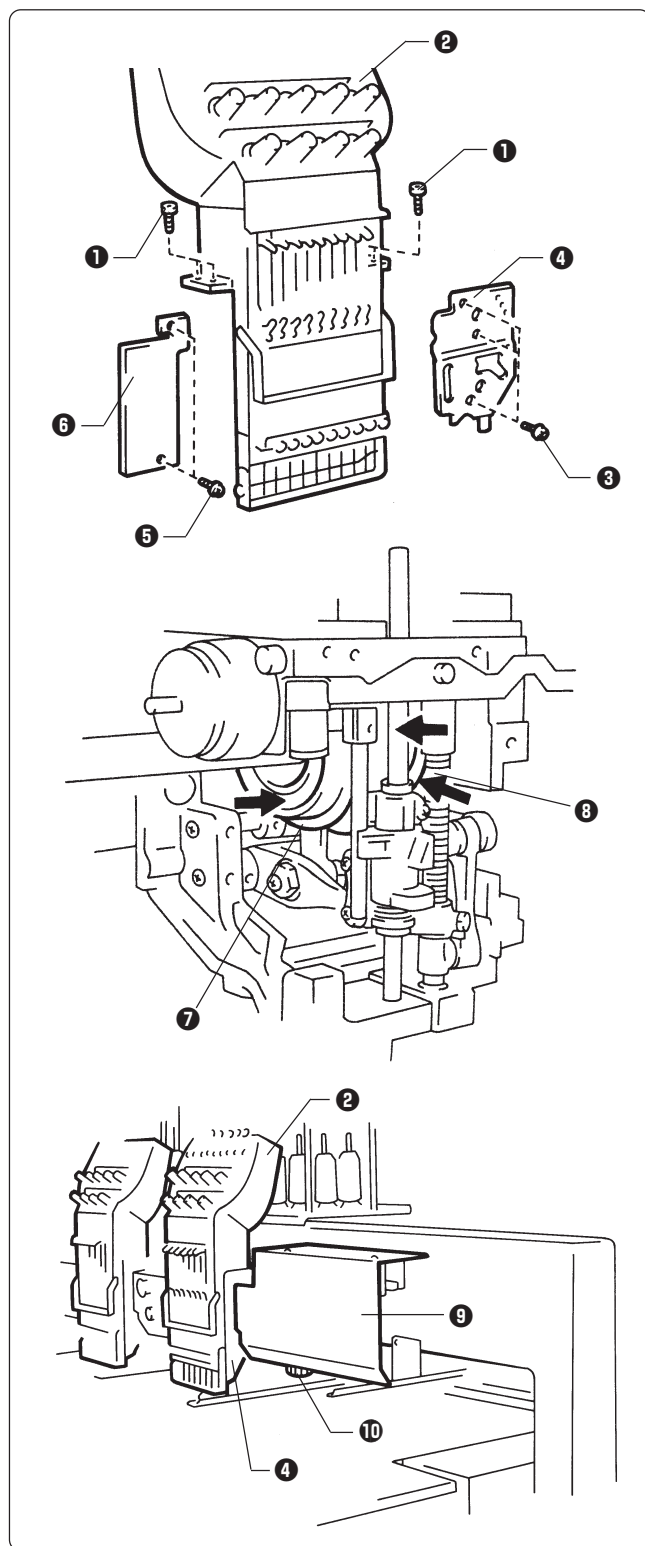

BES-961BC

1. Remove two connectors from the rear of the needle bar case.
2. Loosen four bolts ①, and remove the needle case ②.
3. Loosen three screws ③, and remove the presser foot guide plate ④.
4. Loosen two bolts ⑤, and remove the arm cover L ⑥.
5. Grease all the grooves of the thread take-up cam ⑦ and the work clamp cam ⑧.
6. After greasing, assemble in the reverse order.

(Note) • When assembling the needle bar case ②, place it on the machine and turn the change pulley ⑩ behind the cover ⑨ at right. Check that it is engaged, and then tighten the bolts.

- When attaching the presser foot guide plate ④, move the presser foot up and down by the retracting lever to check that it is not distorted.

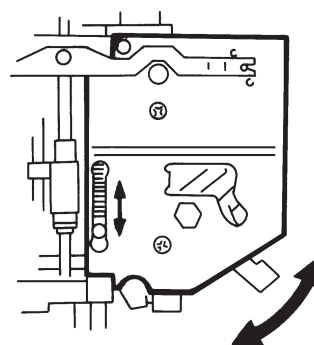

BES-1261BC

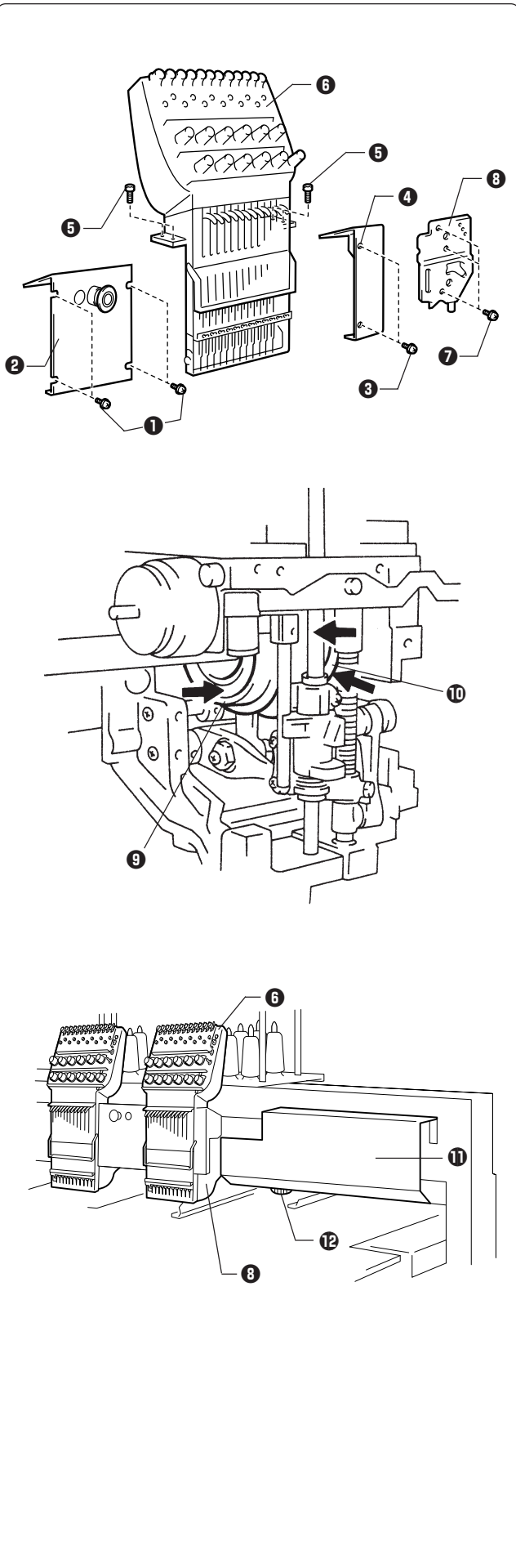

1. Remove two connectors from the rear of the needle bar case.
2. Loosen four screws **1**, and remove the head cover **2**, and loosen two screws **3** and remove the head cover R **4**.
(Note) Because the heads No.1 and No.2 have the head covers R and L respectively, remove both the the covers when greasing.
3. Loosen four bolts **5**, and remove needle bar case **6**.
4. Loosen three bolts **7**, and remove presser foot guide plate **8**.
5. Grease all the grooves of the thread take-up cam **9** and the work clamp cam **10**.

6. After greasing, assemble in the reverse order.

(Note) • When assembling the needle bar case **6**, place it on the machine and turn the change pulley **12** behind the cover **11** at right. Check that it is engaged, and then tighten the bolts.

- When attaching the presser foot guide plate **8**, move the presser foot up and down by the retracting lever to check that is it not distorted.

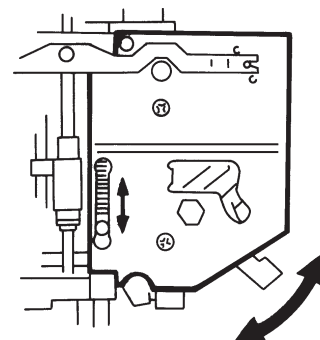

■ Grease the places indicated by the arrow once in six months.

(Note) When greasing, be sure to use the grease tank BR2 (black) provided with the machine.

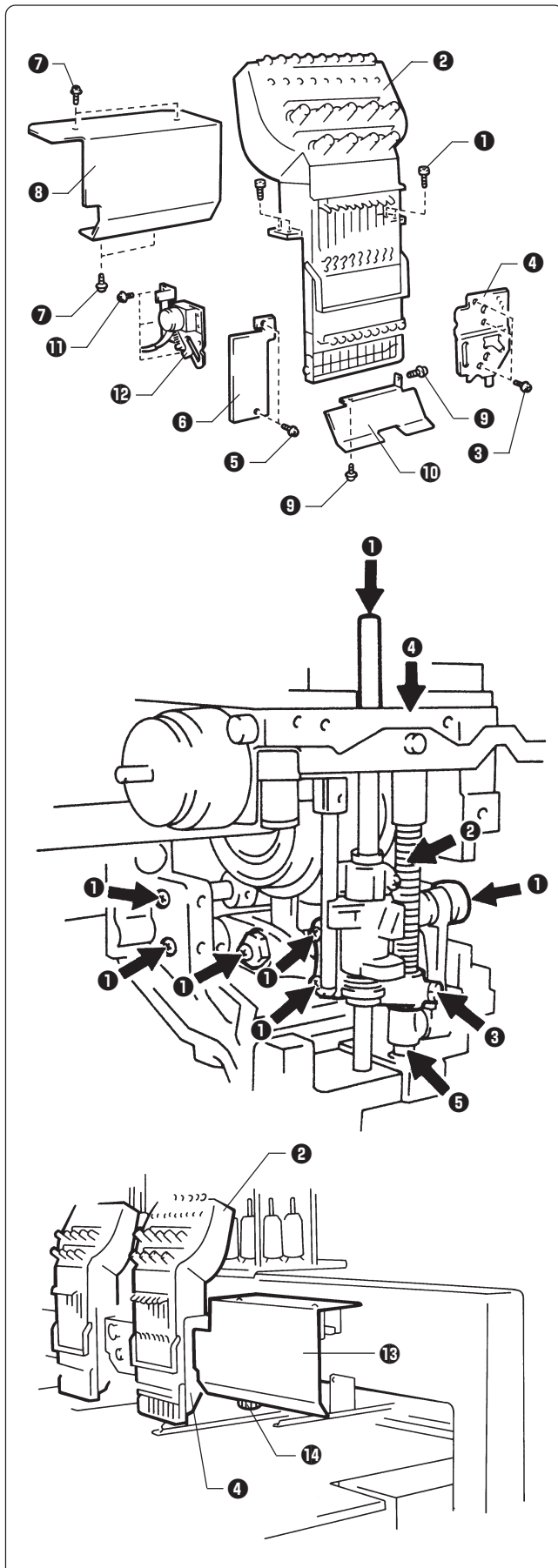

BES-961BC

1. Remove two connectors from the rear of the needle bar case.
2. Loosen four bolts ①, and remove the needle case ②.
3. Loosen three screws ③, and remove the presser foot guide plate ④.
4. Loosen two screws ⑤, and remove the arm cover L ⑥.
5. Loosen four screws ⑦, and remove the head cover ⑧.
6. Loosen two bolts ⑨, and remove the cap eaves guide ⑩.
7. Loosen three bolts ⑪, and remove the wiper solenoid assembly ⑫.
8. Remove the screws at the places indicated by the arrow, insert grease into the tapped hole using the syringe. Then tighten the bolts.
9. After greasing, assemble in the reverse order.

- (Note)
- When assembling the needle bar case ②, place it on the machine and turn the change pulley ⑭ behind the cover ⑬ at right. Check that it is engaged, and then tighten the bolts.
 - When attaching the presser foot guide plate ④, move the presser foot up and down by the retracting lever to check that it is not distorted.

For more information, refer to the illustration in step 6 on page 133.

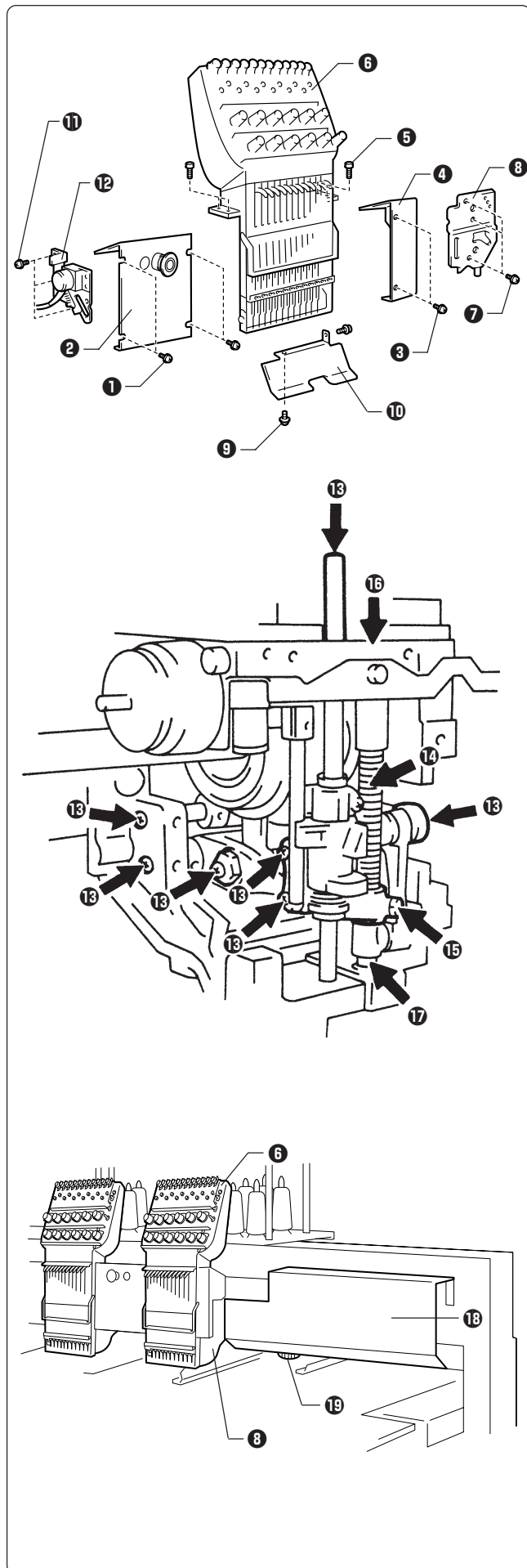

BES-1261BC

1. Remove two connectors from the rear of the needle bar case.
2. Loosen four screws **1**, and remove the head cover **2**, and loosen two screws **3** and remove the head cover R **4**.
(Note) Because the heads No.1 and No.2 have the head covers R and L respectively, remove both the the covers when greasing.
3. Loosen four bolts **5**, and remove the needle case **6**.
4. Loosen three screws **7**, and remove the presser foot guide plate **8**.
5. Loosen two bolts **9**, and remove the cap eaves guide **10**.
6. Loosen three bolts **11**, and remove the wiper solenoid assembly **12**.
7. Remove the screws **13** at the places indicated by the arrow, insert grease into the tapped hole using the syringe. Then tighten the screws. Also grease the presser bar spring **14**, the pressure bar guide bracket **15**, the pressure bar metal U **16** and D **17**.
8. After greasing, assemble in the reverse order.
(Note) • When assembling the needle bar case **6**, place it on the machine and turn the change pulley **19** behind the cover **18** at right. Check that it is engaged, and then tighten the bolts.
• When attaching the presser foot guide plate **8**, move the presser foot up and down by the retracting lever to check that is it not distorted.
For more information, refer to the illustration in step 6 on page 134.

3-2 Feed Guide Section

- Check the X-feed linear guides (3 positions) and the Y-feed linear guides (one each on the right and left).

(Note) When greasing, be sure to use the grease tank 30 provided with the machine.

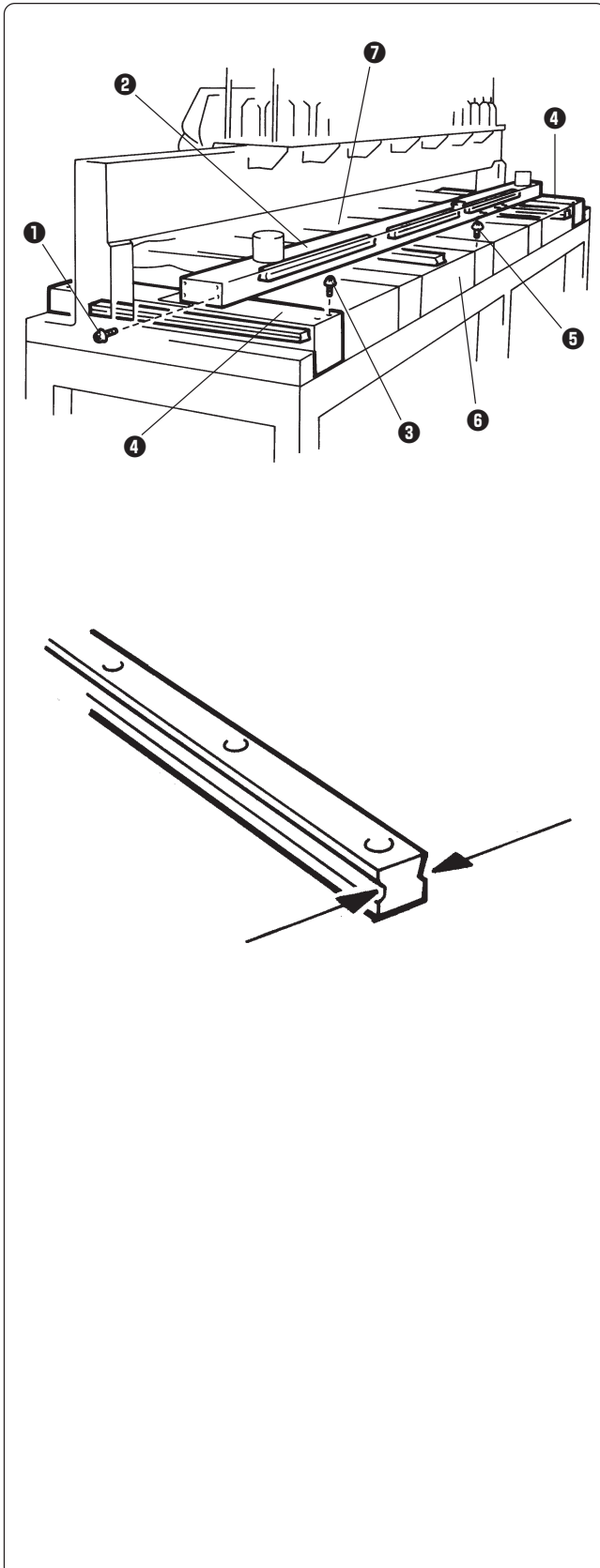

Procedure

1. Loosen 12 screws **①**, and remove the X-feed cover **②**.
2. Loosen eight screws **③**, and remove the Y-feed cover **④** from the right and left.
3. Loosen 13 screws **⑤**, and remove the bed covers B **⑥** and C **⑦**.
4. Grease the X-feed linear guides (3 positions), the Y-feed linear guides (one each on the right and left), and the linear guide inside the No. 3 bed. Slide the guide to spread grease entirely.
5. After greasing, assemble in the reverse order.



Chapter 8 Standard Adjustment

⚠ CAUTION



Turn off the power switch and pull out the plug before starting adjustment. Failure to do so may start the machine unintentionally through an accidental activation of the START switch, resulting in bodily injuries.

- Adjustment



If adjustment should be made while the power switch is turned on, pay special attention to your safety.



Maintenance and inspection of the machine should be conducted only by trained engineers.

1. Adjusting Needle Bar Height

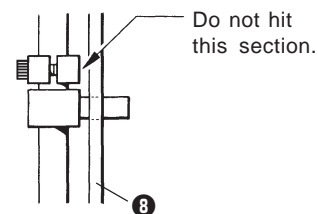
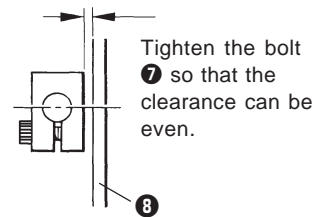
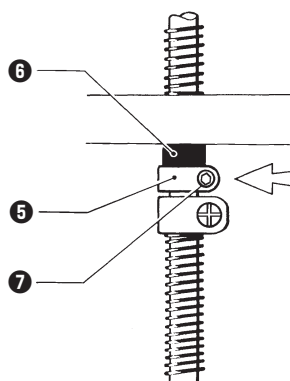
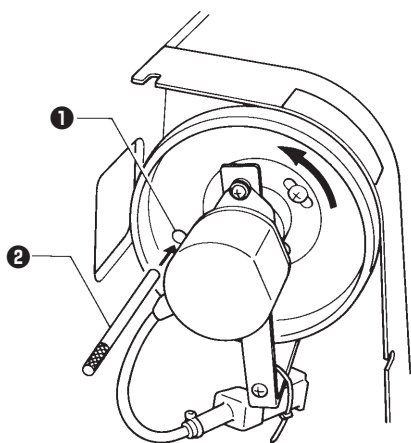
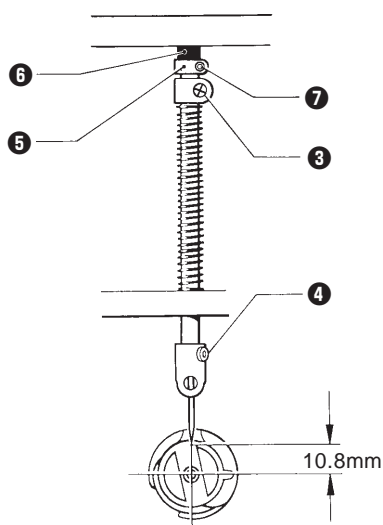
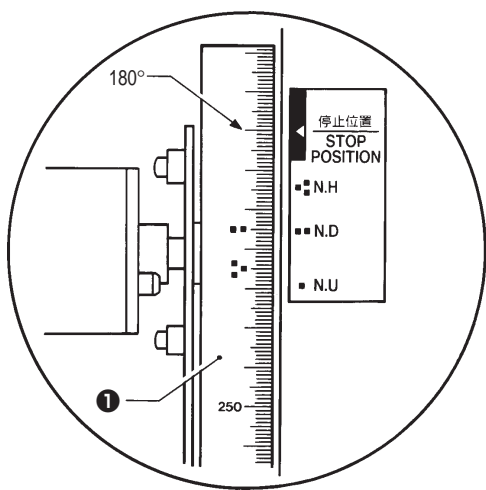

1. Dismount the pulley cover and turn the pulley B ❶ until the pulley scale indicates 180° and the needle bar is set at the lowest position. (The pulley B "■" mark and the stop mark "■" are aligned.)
2. Insert the positioning bar ❷ into the hole of the pulley ❶ and fix the drive shaft.
Note) Turn the pulley B securely in the clockwise direction to eliminate a backlash.
3. Loosen the needle bar clamp set screw ❸ and the bolt ❷ of the top dead center stopper ❺ when the needle tip is positioned 10.8 mm above the center of the rotary hook shaft. Adjust the position of the needle bar thread guide so that the set screw ❹ on it is turned to the right by 25 ~ 30°. Tighten the needle bar clamp set screw ❸ securely.
Note) When tightening the needle bar clamp set screw ❸, the hole in the needle bar guide should face the front.
4. After adjustment is finished, remove the positioning bar ❷.
5. Set the needle bar at the highest position (where the pulley B indication mark "■" and the cover indication mark "■" are aligned). Lightly press the top dead center stopper ❺ toward the cushion rubber ❻, and tighten the top dead center stopper bolt ❷ while pressing down the needle bar clamp so that it faces the front.
Note)
 - Make sure that the top dead center stopper does not hit the needle bar guide rail ❸ at this time.
 - When tightening the upper dead point stopper bolt ❷, insert the longer side of the attached wrench into the bolt and tighten it by using the shorter side.
Excessive tightening may make the needle bar movement sluggish.

■ When using the bottom dead center gauge

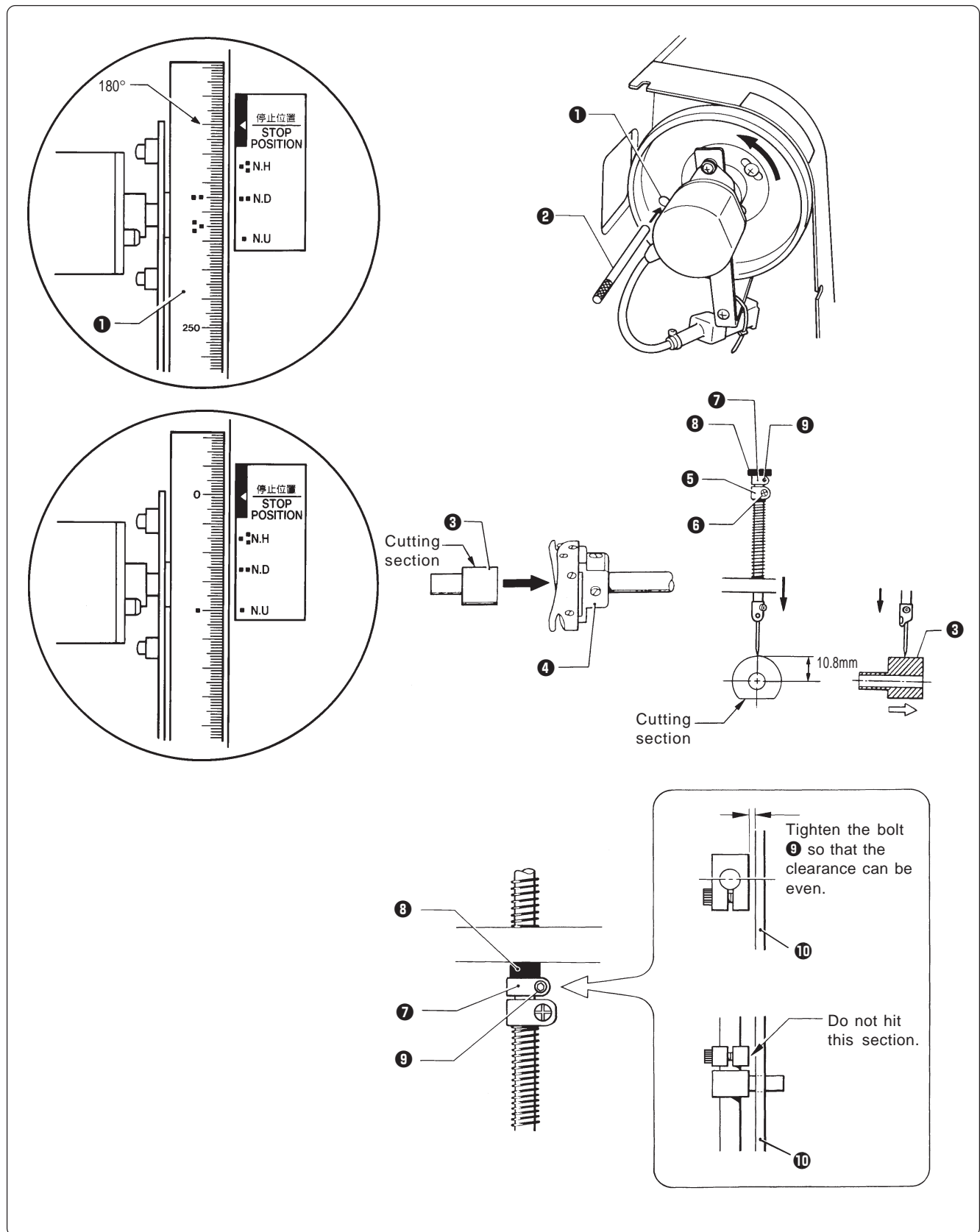

1. Turn the pulley B ❶ until the scale of pulley B ❶ indicates 180° (where the pulley B indication mark "■" and the stop mark "■" are aligned) and the needle bar is set at the lowest position.
2. Insert the positioning bar ❷ into the hole of the pulley B ❶ and fix the drive shaft.
Note) Turn the pulley B securely in the clockwise direction.
3. Insert the bottom dead center gauge ❸ into the rotary hook ❹.
4. Loosen the screw ❻ of the needle bar clamp ❺ and the top dead center stopper bolt ❾, then move the needle bar up and down until the needle tip touches the gauge ❸ lightly.
Note)
 - The needle point should touch the gauge at a place other than the cutting section.
 - The bottom dead center gauge should be set in or removed from the rotary hook with its cutting section facing upward.
5. Tighten the screw ❻ of the needle bar clamp ❺ securely.
6. After adjustment is finished, remove the positioning bar ❷.
7. Set the needle bar at the highest position (where the pulley B indication mark "■" and the cover indication mark "■" are aligned). Lightly press the top dead center stopper ❷ toward the cushion rubber ❸, and tighten the top dead center stopper bolt ❾ while pressing down the needle bar clamp so that it faces the front.
Note)
 - Make sure that the top dead center stopper ❷ does not hit the needle bar guide rail !0 at this time.
 - When tightening the upper dead point stopper bolt ❾, insert the longer side of the attached wrench into the bolt and tighten it by using the shorter side.
Excessive tightening may make the needle bar movement sluggish.

2. Replacing (Attaching) Rotary Hook

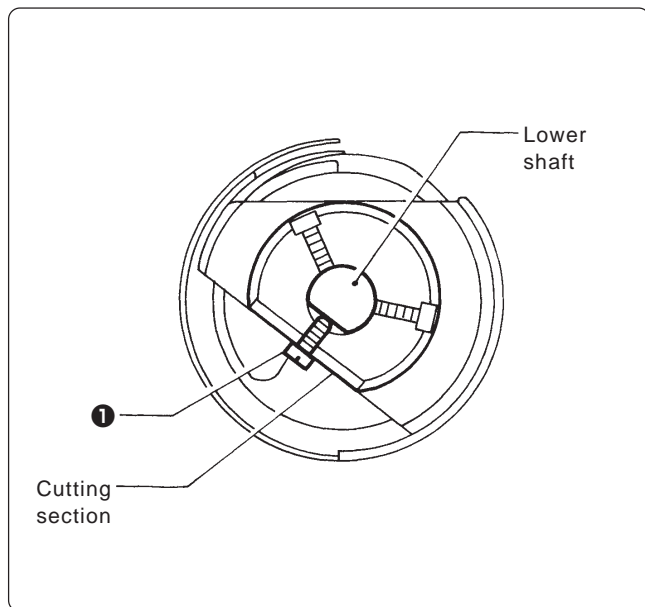

1. Turn the power switch off.
2. Tighten the screw **1** of the rotary hook cutting section to fit to that of the lower shaft **2**.
3. When mounting, press it inward until it stops.

Note) After replacing rotary hooks, refer to "4. Adjustment of Timing Between Needle and Rotary Hook (Page 146)" and adjust the timing.

3. Adjustment of Clearance Between Needle and Rotary Hook

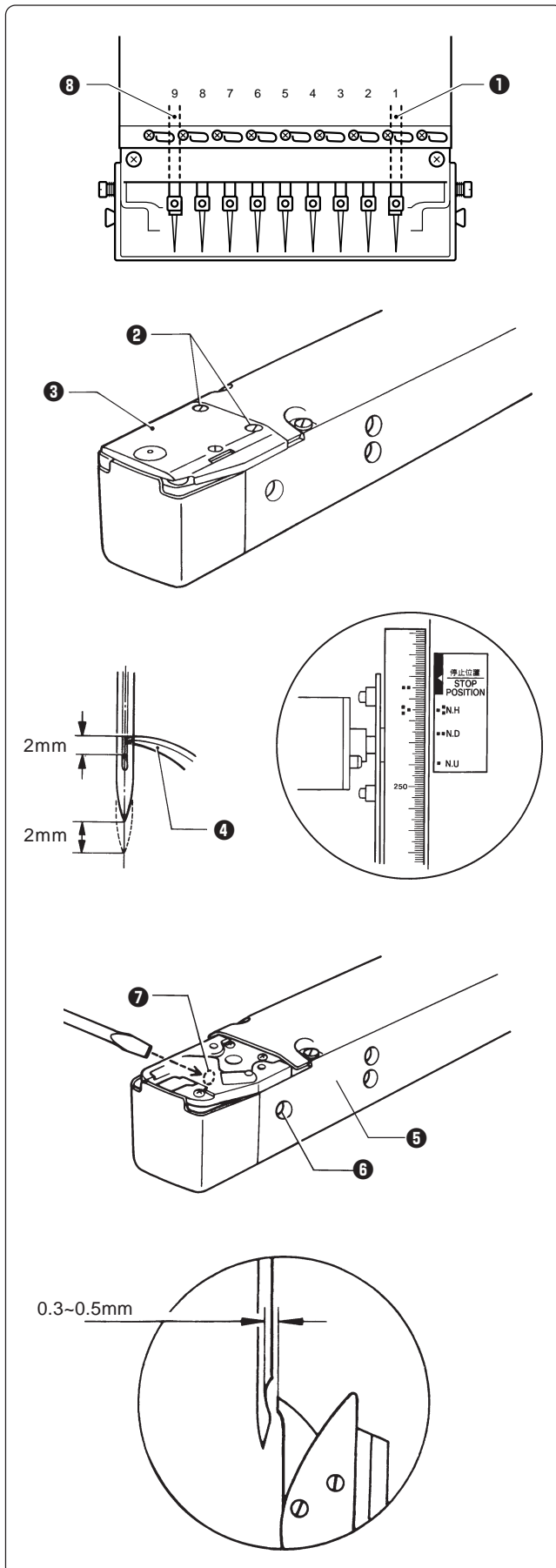

1. Turn the power switch off.
2. Select the needle bar No. 1 **①**.
The illustration at the left shows the case of BES-961BC. For BES-1261BC, the No. 12 needle becomes 9.
3. Remove two flat screws **②** and dismount the needle plate **③**.
4. Turn the pulley B until the pulley indication mark "■" and the stop mark "NH■" are aligned.
5. Turn the rotary hook **④** manually so that the rotary hook point is aligned properly.
6. Loosen the set screw **⑥** on the side of the bed **⑤**.
7. Turn the eccentric screw **⑦** on the left side of the bed **⑤** using a regular screwdriver and adjust a clearance between the needle and the rotary shaft to 0.3 ~ 0.5 mm.
8. Adjust the clearance between the needle and the rotary hook's point to 0.3 ~ 0.5 mm at the needle bar No. 9 **⑧** (No. 12 needle for BES-1261BC).

Note) If the clearance between the needle and the rotary hook point is not within the range of 0.3 ~ 0.5 mm, adjust again as described in the step **④** until the needle bar No. 1 or No. 9 (No. 12 for BES-1261BC) whichever has the smallest clearance may not be interfered by the rotary hook point.

4. Adjustment of Timing Between Needle and Rotary Hook

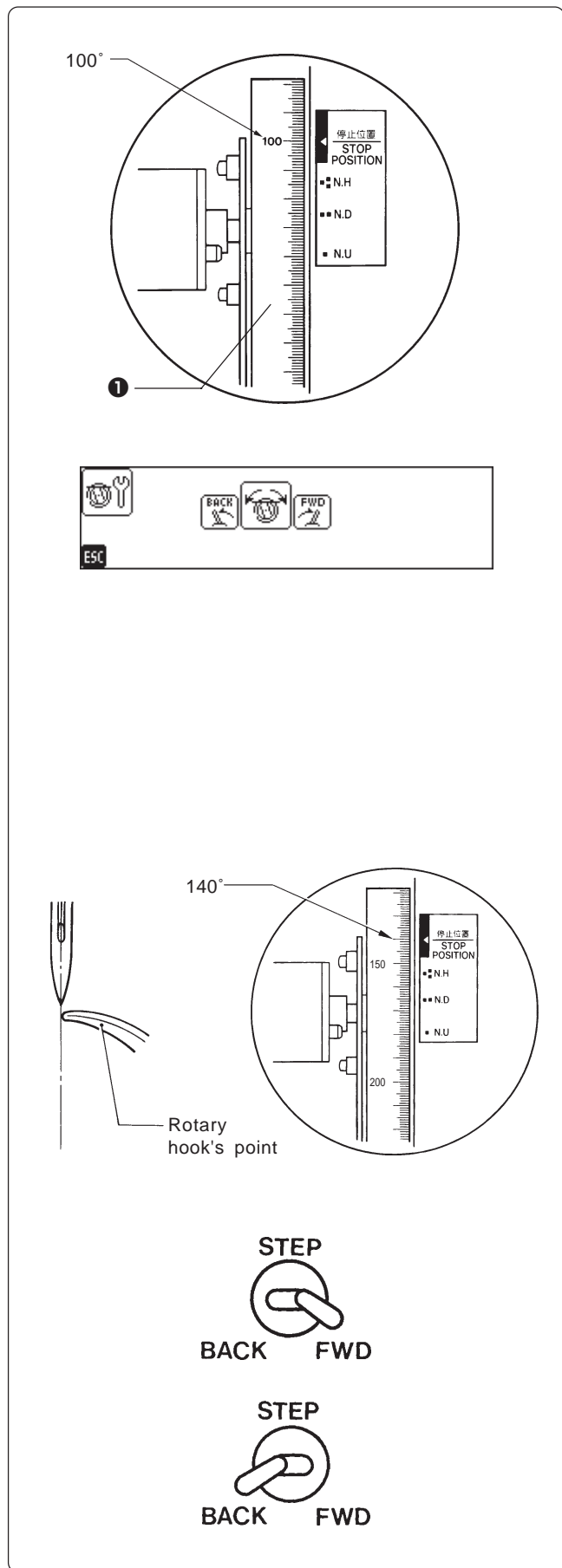

1. Turn the power switch on.
2. Check that the machine pulley B ❶ is at the stop position (at 100° of the scale). If not, turn the pulley B ❶ until it comes to the stop position.
3. While the machine is at the stop position (when the initial screen or halt screen is displayed), press the ▽ while holding down the . The rotary hook of each head turns to a currently set alignment position for adjustment of the rotary hook.
4. Turn the pulley B ❶ manually until the relationship between the needle point and the rotary hook's point can be easily checked (at around 140° of the scale).
5. Press the STEP BACK/FWD switch to move the rotary hook for each head to adjustment.
 - STEP BACK
For rotating the rotary hook little by little in the clockwise direction
 - STEP FWD
For rotating the rotary hook little by little in the counterclockwise direction

Make this adjustment for each machine head so that the needle and the rotary hook's point can fit with each other.

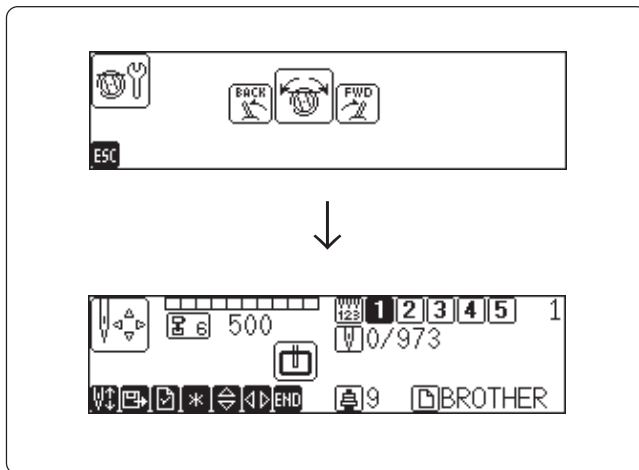

6. After timing adjustment the is finished for each head, set the pulley B ❶ to the stop position (at 100° of the scale) and press **ESC**. The machine enters the standby state.

The adjustment of the rotary hook is completed and the timing is stored. The rotary hook returns to the stop position accordingly.

5. Adjustment of Presser Foot Height

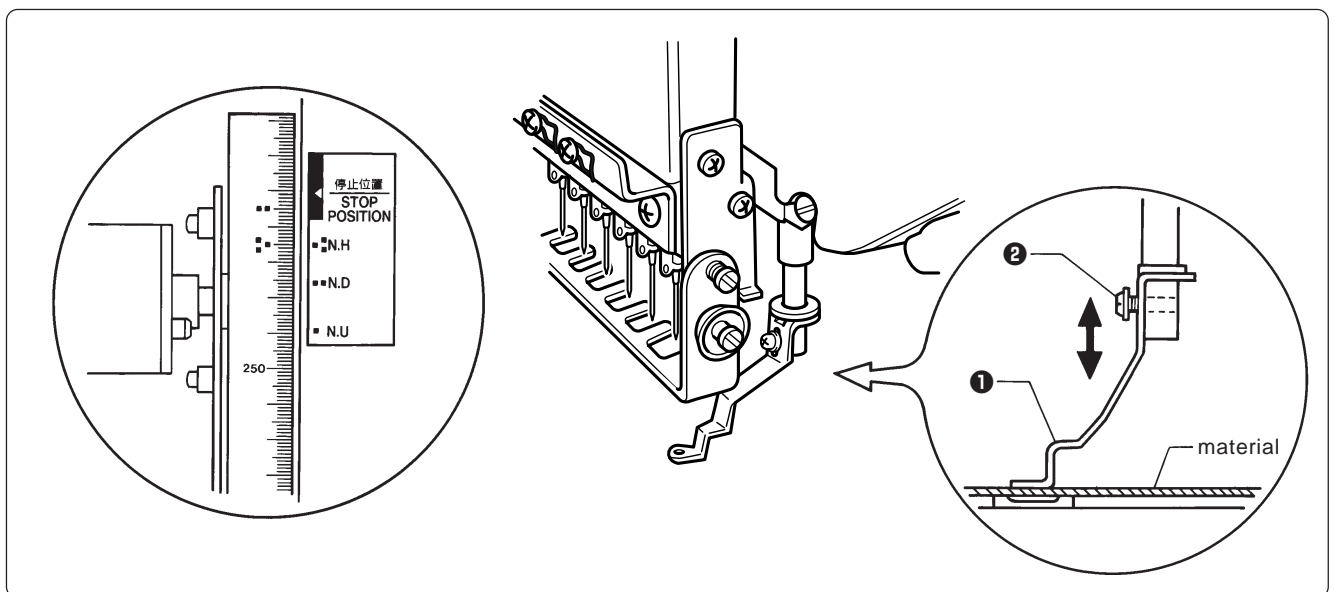

1. Turn the power switch off.
2. Select the needle bar No. 1.
3. Loosen the screw ❷ of the presser foot ❶, and adjust the presser foot ❶ until it comes above the cloth top surface when it is at the alignment position (where the pulley B indication mark "■" and the cover indication mark "■" are aligned).

6. Adjustment of Thread Trimmer

6-1 Attaching the Fixed Knife

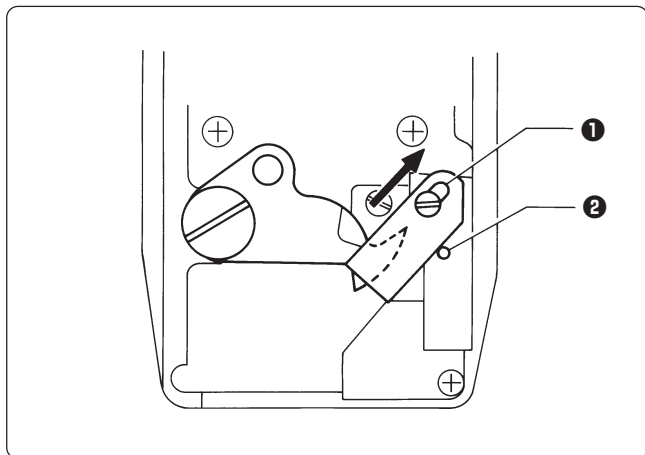

Attach the fixed knife **1** to the pin **2** and move it backward to the end of the slot, then mount it there.

6-2 Checking the Movable Knife Position

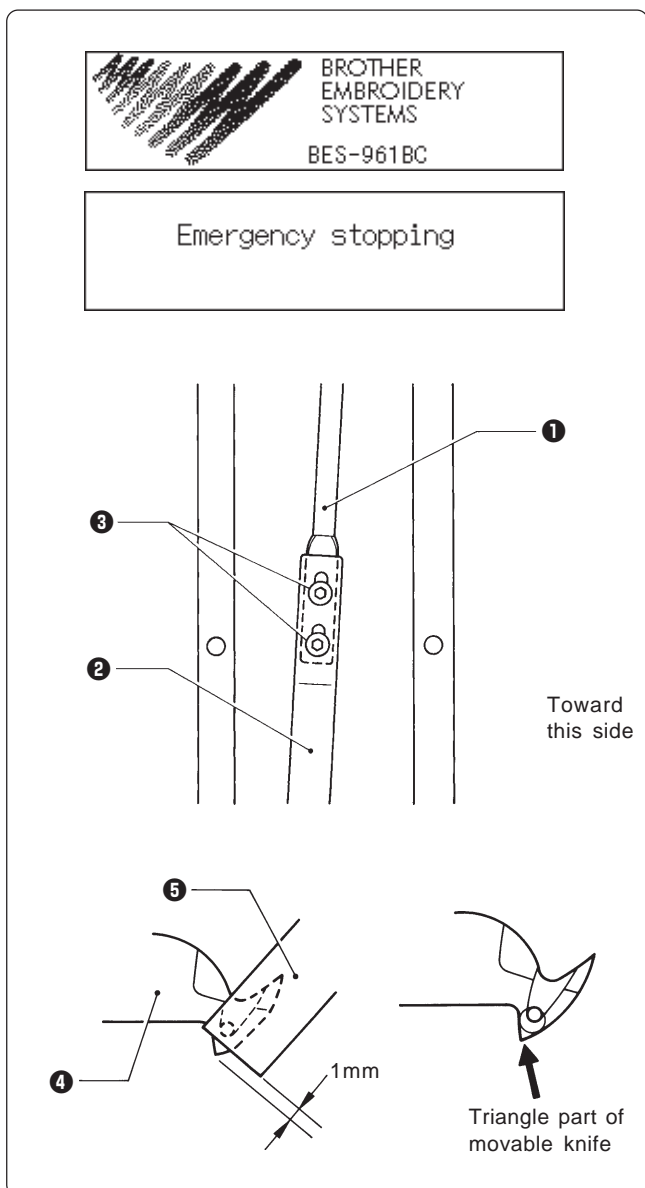

1. Turn the power switch on and wait until the hoop home position detection is finished.
2. Press the Emergency stop switch in order to ensure maximum safety during adjustment.

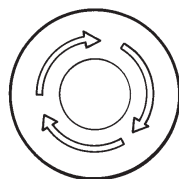

Adjust the movable knife position in this state.

3. Loosen two bolts **3** that connect the thread trimmer connecting rods B **1** and C **2**.

4. Tighten the two bolts **3** until the triangle part of the movable knife **4** is projected by 1 mm from the fixed knife **5**.

* Precautions for tightening the two bolts **3**:

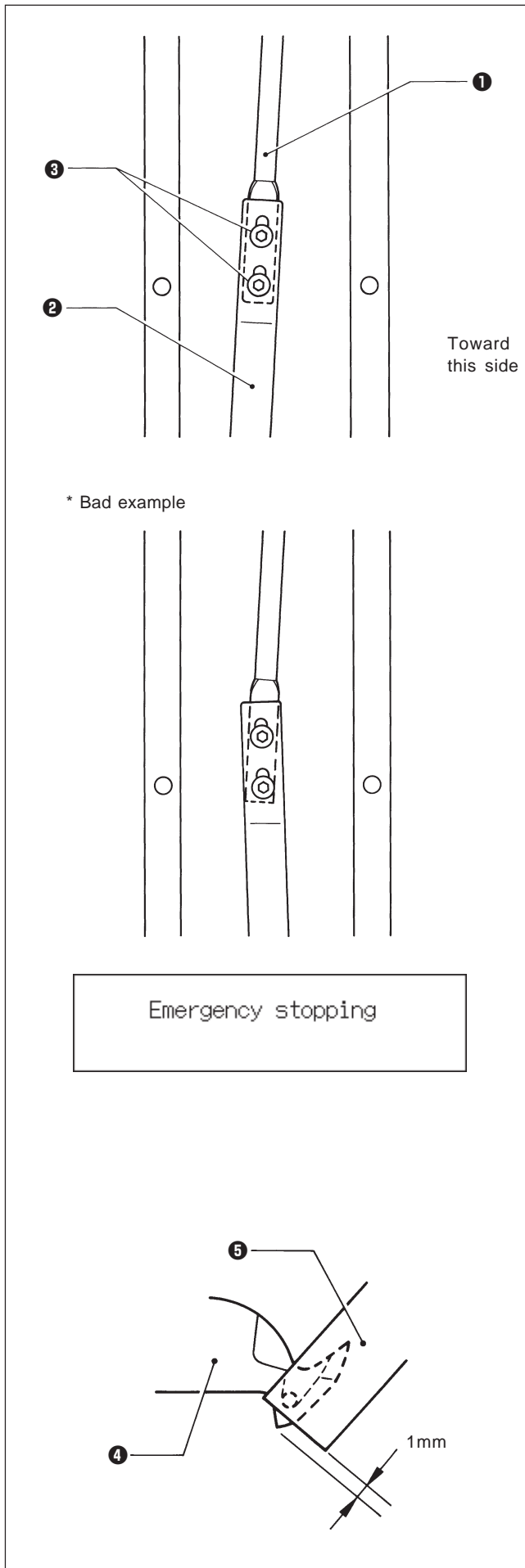

- The thread trimmer connecting rod B **1** has a backlash of about 0.1 ~ 0.2 mm back and forth. Tighten the two bolts **3** while pulling them forward by the backlash amount.
- Tighten the two bolts **3** so that the thread trimmer connecting rods B **1** and C **2** are positioned in a straight line.

5. After adjustment is finished, reset the emergency stop button. "Emergency Stopping" disappears.
6. Turn the power switch off once, then on again. Check that the clearance between the movable knife **4** and the fixed knife **5** is 1 mm.
7. When adjusting again, follow the step 2 and after.

6-3 Adjusting the Belt Tension

The belt Tension is adjusted to the optimum tension at the time of shipment from the factory. However, as the belt is used, it becomes run in and may loosen around the machine pulley and motor pulley. Use the following procedure to check the belt tension.

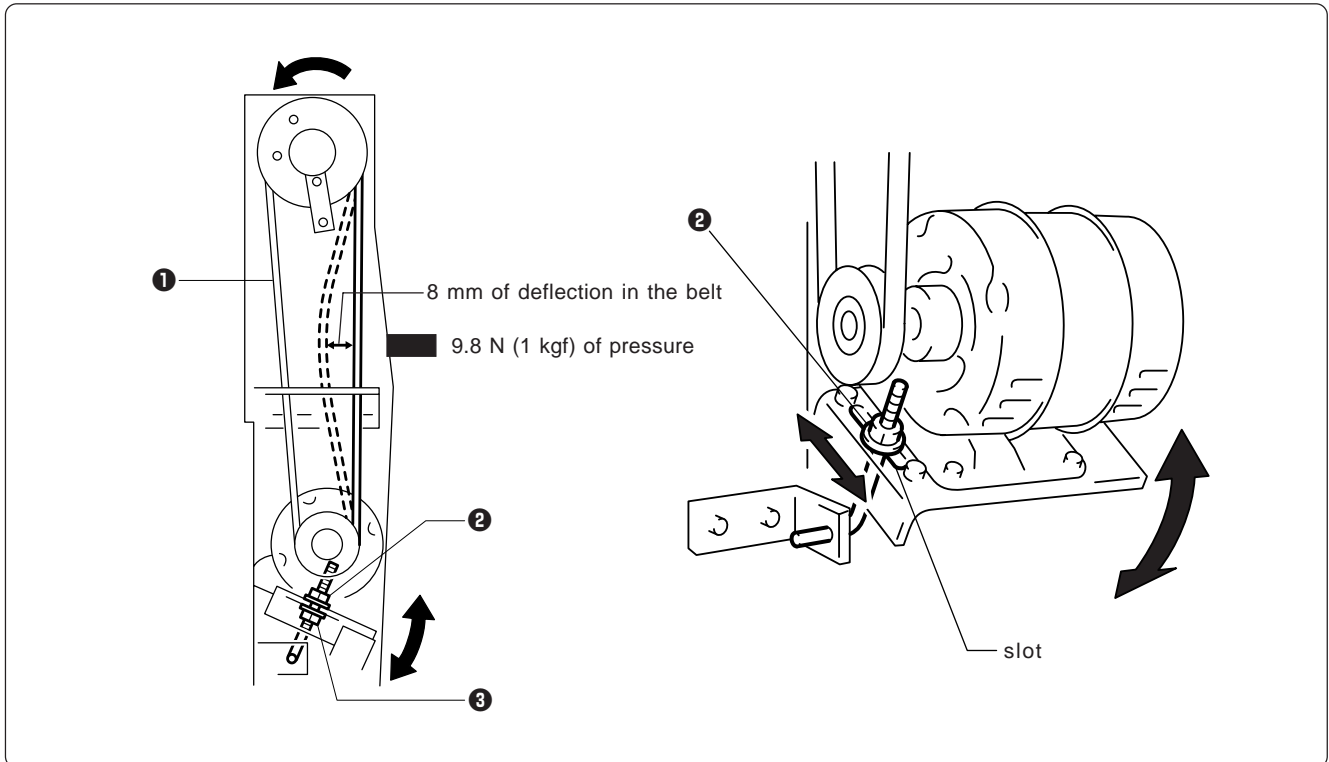













Place a gauge against the belt **1**, loosen the nut **2**, and then turn the nut **3** to move the slot to the appropriate position so that there is 8 mm of deflection in the belt **1** when 9.8 N (1 kgf) of pressure is applied.









The machine operating direction is counterclockwise when seen from the machine pulley end.



Chapter 9 List of Error Messages

Code	Error	Measures
E-02	Overtravel error during home positioning detection	Turn the power off once, then on again. If the same error occurs again, the area sensor is faulty.
E-03	Stop SW was pressed during home positioning	Press  and clear the error message. Pressing  restarts the home position detecting movement again.
E-04	Zero positioning is out of range	Turn the power off once, then on again. If the same error occurs again, the X- or Y-axis mechanism is faulty.
E-05	Needle stop position error	Adjust the pulley stop position (100°) above the needle and press  .
E-06	Needle bar case position error	Press  . If the error persists, the color-change mechanism is faulty.
E-07	Needle bar case lock	
E-09	X-axis home position error	Turn the power off once, then on again. If the same error occurs again, the X-axis mechanism is faulty.
E-0A	Thread breakage error	After passing through the thread, press  .
E-14	Y-axis home position error	Turn the power off once, then on again. If the same error occurs again, the Y-axis mechanism is faulty.
E-18	X-axis stepping motor connector error	Check that the connector of the X-axis stepping motor is properly connected, and press  .
E-21	Area over	Set the embroidering area again or move the hoop to a sewable position. (The hoop can be moved to a sewable position by pressing  .)
E-22		
E-23		
E-24		
E-25		
E-26		
E-27		
E-28		
E-29		
E-2A		
E-2B		
E-2C		
E-2D		
E-2E		
E-2F		

Code	Error	Measures
E-31	Area over	Set the embroidering area again or move the hoop to a sewable position.
E-32		
E-33		
E-34		
E-36		
E-38		
E-39		
E-3C		
E-A1	Main(Z) motor lock	Press  . If the same error occurs frequently, the spindle mechanism is faulty.
E-A2	Main PCB temperature is too high	Turn the power off once, then on again. If the same error occurs again, the spindle motor or main PC board is faulty.
E-A3	Main(Z) motor voltage is too low	
E-A4	Main(Z) motor voltage is too high	
E-B0	Lower shaft CPU error	Press  .
E-B1	Thread jammed in rotary hook	Check that no lint is tangled in the rotary hook and press  .
E-B2	Hook motor origin point error	
E-B3	Hook motor standby position error	Press  .
E-B4	Hook motor mode error	
E-B5	Hook motor communication error	
E-B6	Hook motor parameter error	
E-B7	Hook motor overheat error	Turn the power off once, then on again. If the same error occurs again, the lower shaft or fan motor is stopped main PC board is faulty.
E-B8	Hook motor overcurrent error Turn off the power	
E-B9	Thread trimming motor origin point error	Turn the power off, and check the thread trimming mechanism. Press  . If the same error occurs again, the thread trimming mechanism is faulty.

Code	Error	Measures
E-BA	Power supply frequency error	Turn the power off once, then on again. If the same error occurs again, the power PC board or power supply is faulty.
E-BC	No power error	Press  .
E-BD	Lower shaft flash memory error	Turn the power off once, then on again. If the same error occurs, the main PC board is faulty.
E-BE	Lower shaft version-up error	Press  and clear the error display and upgrade the version again.
E-C1	Area over during embroidering	Set the embroidering area again.
E-C2	Wiper out error	If the wiper is tangled with a thread, remove it. Then press  .
E-C4	Presser foot down error	Press  .
E-CB	Main(Z) motor speed error	Press  and clear the error display. Then press  . If the same error occurs again, there is a possibility that the spindle is overloaded.
E-CE	Cylinder bed position error	Secure to bed.
E-D0	Power PCB error	Turn the power off once, then on again. If the same error occurs again, the power PC board is faulty.
E-D1	Cooling fan motor stop	Turn the power off. Check that the fan on the left or bottom rear of the control box is not tangled with a harness, etc. before turning the power on again. If the same error occurs again, the fan or the power PC board is faulty.
E-D2	Power voltage upper limit error	Press  . If the same error occurs again, the power PC board or the power supply is faulty.
E-D3	Power voltage lower limit error	
E-E1	X-axis pulse motor overcurrent stop Turn off the power	Turn the power off once, then on again. If the same error occurs again, the pulse motor or the main PC board is faulty.
E-E2	Y-axis pulse motor overcurrent stop Turn off the power	
E-E3	Exhaust fan motor stop	Press  . If "OFF" is displayed, turn the power off. Check that the fan at the right rear of the control box is not tangled with a harness, etc. before turning the power on again. If the same error occurs again, the fan or the power PC board is faulty.
E-E4	Hook motor error	Finish the test mode or turn the power OFF once, then ON again. If the same error occurs again, the main PC board is faulty.



Chapter 10 Troubleshooting

If there is any indication of trouble with the machine, check and correct as described in the table. If the trouble cannot be corrected, turn off the power and contact your distributor for corrective actions.

Mechanical Section

	Problem	Check Point
Check these points once again	<ul style="list-style-type: none"> ■ Thread breakage 	<ul style="list-style-type: none"> • Is the machine properly threaded? • Is thread tension too high? • Is the rotary hook assembly clogged? • Is there thread in the bobbin? • Is the needle bent? • Is there a rough edge or flaw on the needle plate, rotary hook, or bobbin case that might cut the thread? • Is the needle installed correctly (direction, angle, etc.) • Is the presser foot in contact with the material? • Are the thread thickness and needle size correct? • Is a thread with right-hand twist being used? (If such a thread is used, replace with a thread with left-hand twist.) • Is there any adhesive on the needle? • Is the material tension too weak? • Is there too much play between the outer rotary hook and inner rotary hook? • Does the outer rotary hook turn smoothly? • Is the clearance between the rotary hook stopper and the rotary hook adjusted correctly? • Does the thread come out from the bobbin case smoothly?
	<ul style="list-style-type: none"> ■ Needle (presser foot) interference with embroidery hoop 	<ul style="list-style-type: none"> • Is the embroidery hoop too small? • Check the size and needle start position in the sewing data.
	<ul style="list-style-type: none"> ■ Needle breakage 	<ul style="list-style-type: none"> • Is the needle attached correctly (direction, height, etc.)? • Is the needle bent? • Is the rotary hook attached correctly? • Is the timing set correctly? • Is there any backlash with the needle bar case (back/forth and right/left)? • Is the rotary hook stopper correctly attached to stop the rotary hook? • Is the needle size correct and the tip sharp? • Does the thread pass through the hole center of the presser foot?
	<ul style="list-style-type: none"> ■ Not embroidered properly 	<ul style="list-style-type: none"> • Is the material edge caught in the machine? (Are embroidery hoop and other related parts operating correctly?) • Is the material stretched properly? • Is thread tension proper? Does the lower thread come out smoothly?

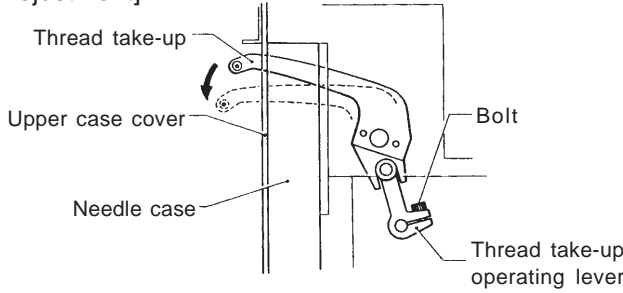
	Problem	Check Point
Check these points once again	■ Machine operation abnormal	<ul style="list-style-type: none"> • Is any set screw of the rotary encoder loosened? • Is any set screw of the machine pulley loosened? • Is any set screw of the machine motor pulley loosened? • Is embroidery data normal?
	■ Upper shaft locks at a certain point in one cycle	<ul style="list-style-type: none"> • Is the thread take-up stopped due to interference with the upper case cover? <p>[Adjustment]</p>  <p>Loosen the hexagon socket head cap screw of the thread take-up operating lever and adjust the take-up movable range. Tighten it securely afterwards.</p> <ul style="list-style-type: none"> • Are the needle bar clamp and the top dead center stopper positioned correctly?
	■ Error display	<ul style="list-style-type: none"> • Check the rotary hook of a machine head whose MENDING lamp (green) is blinking to see if the thread is caught. <p>[Adjustment]</p> <ol style="list-style-type: none"> 1. Take out the thread tangled in the rotary hook race so that the rotary hook can be rotated forcibly by manual operation. 2. Check that the machine pulley is set to 100° of the scale, and press the END switch. <p>[Measures]</p> <ol style="list-style-type: none"> 1. If the thread end is left too long or stitching is left loosened before starting embroidering, the thread is caught in the machine and operation stops. 2. When starting embroidering, hook the thread end on the spring or hold it with a hand. 3. Leave thread of about 60 ~ 70 mm from the needle hole when starting embroidering.
	■ Upper shaft pulley does not turn.	<ul style="list-style-type: none"> • Is the presser foot lifted at a retract position when the power is turned on? <p>Lower the presser foot for the six machine heads using the lever.</p>
■ Stitches cannot be made.	<ul style="list-style-type: none"> • Is the needle attached properly? • Is the timing of the needle and rotary hook correct? 	

Electrical Section

	Trouble	Check Point
Check these points once again	■ The operation panel is not displayed though the power switch of the machine is turned ON.	<ul style="list-style-type: none">• Is the cable correctly plugged in?• Is the connector securely connected from the operation panel to the control box?
	■ An error is indicated on the operation panel, and no operation is possible.	<ul style="list-style-type: none">• Refer to the error message list for troubleshooting. If the error persists, contact your distributor.



Connection and Installation of Optional Equipment

Attaching Bobbin Winder

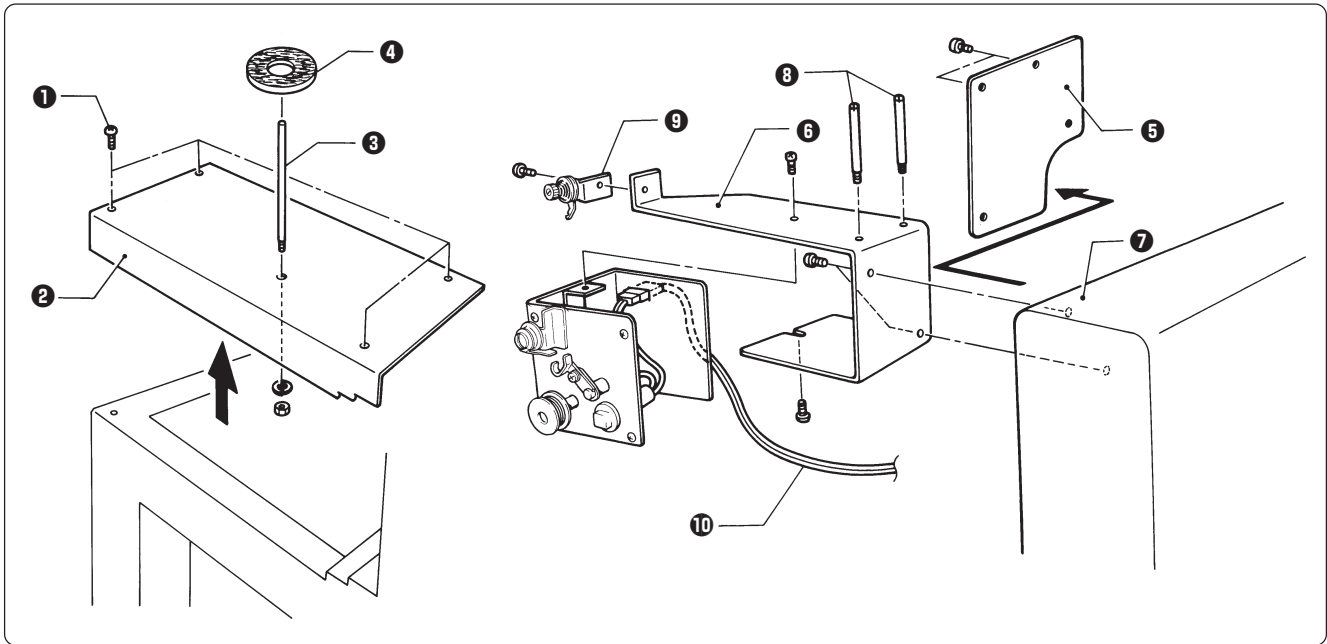

1. Remove four screws ❶ and dismount the side cover LB ❷.
2. Set the spool shaft B ❸ into the hole of the removed side cover LB ❷ and fix the shaft with a nut and a spring washer. Then put the spool mat A ❹ through the spool shaft B ❸.
3. Remove two screws and dismount the bridge cover B ❺.
4. Mount the bobbin winder stay ❻ on the bridge ❼ along with the bridge cover B ❺ using two screws removed from the bridge cover. Then mount the bobbin stand L ❽ on the bobbin winder stay ❻.
5. Mount the bobbin winder assembly ❾ on the bobbin winder stay ❻ using screws.
6. Insert the bobbin winder harness ❿ in the 2P (No. 6) connector on the rear side of the control box.
 Note) Be careful not to allow the bobbin winder harness to come into contact with the hoop in motion.
7. Mount the side cover LB ❷ using four screws ❶.

■ Winding lower thread

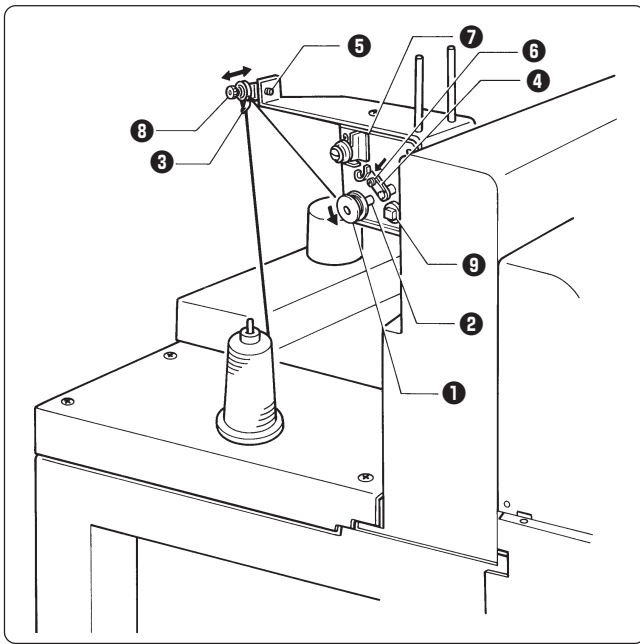

1. Turn the power switch on.
2. Set the bobbin **1** in the bobbin winder shaft **2**.
3. Put the thread through the thread guide **3**.
4. Wind the thread around the bobbin **1** several times in the direction of the arrow.
5. Press the bobbin hold **4**.

Note) If the thread cannot be wound evenly, loosen the screw **5** and move the thread guide **3** right and left for adjustment.

In order to wind more threads around the bobbin, loosen the thread **6** and move the bobbin hold **4**.

6. After winding is finished, pull out the bobbin from the bobbin winder shaft and trim the thread using the thread trimmer **7**.

Note) • If the thread is wound too tight and comes off from the tension disk, loosen the knob **8**. If the thread is too loose, tighten the knob **8**.

- If the circuit protector **9** functions, the bobbin winder motor does not rotate. Leave it for a while for cooling. Then press the circuit protector **9**. (The thread does not come out when the motor is not cooled enough.)

brother[®]

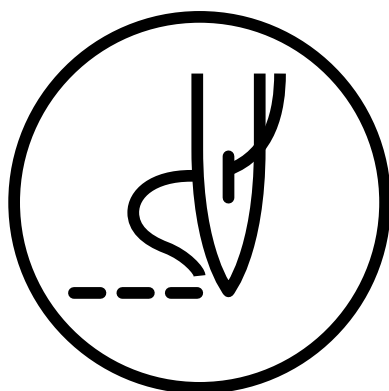

INSTRUCTION MANUAL

BROTHER INDUSTRIES,LTD. NAGOYA,JAPAN

Printed in Japan

155-961BC,C61
S93961-102
1998.08. B (1)