

# BAS-610A · 611A

# BAS-612A · 613A









## Automatic Lockstitch Pocket Welt Sewer

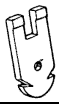









### Specifications

	BAS-610A	BAS-611A	BAS-612A	BAS-613A
Machine head	Automatic lockstitch pocket welt sewer		Automatic lockstitch slant pocket welt sewer	Automatic lockstitch pocket welt sewer
Sewing speed	2,500 rpm (Can be changed to 2,200 rpm by DIP switch setting)			
Stitch pitch	Standard at 2.0 mm (Variable within 1.8 – 3.2 mm by DIP switch setting)			
Tacking length	Condensed	Standard at 1.0 mm (*variable within 0.4 - 1.0 mm by DIP switch setting)		
	Backtack	Standard at 2.0 mm (*variable within 0.8 - 2.0 mm by DIP switch setting)		
Flap sewing	No		Yes	No
Slant welting	No		Yes	No
Needle gauge	8, 10, 12, 14, 16, 18, 20, 22, 24, 26 mm (22, 24, 26 mm : Special order)		8, 10, 12, 14, 16, 18, 20 mm	
Needle	Mt × 190 #16 (#16 - #18)			
Stacker	Yes (Option)			
Device	Automatic welt piece and flat feeder			Zipper attachment
Seam length (Pocket size)	Gauge size 14 mm or less	28 - 190 mm	36 - 190 mm	28 - 190 mm
	Gauge size 16 mm or more	36 - 190 mm		36 - 190 mm
	Flat sewing	-	80 - 180 mm	-
Cycle production	Cycle sewing of 2 – 5 sizes. Up to 6 pockets			
Air pressure	0.5 Mpa			
Air consumption	10 l / min.			
Power supply	3-phase 50 / 60 Hz 220 V, 230 V, 240 V, 380 V, 415 V 500W			
Machine dimensions	(W) 820 mm × (D) 1,300 mm × (H) 1,155 mm			
Weight	190 kg			





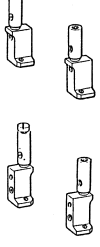

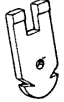

## Gauge parts list

Part name		Needle gauge					Q'ty
		8 mm	10 mm	12 mm	14 mm	16 mm	
Thread trimmer	Needle thread trimmer movable knife 	Needle thread knife (8 -12) (S08403-001)			Needle thread knife (14 - 16) (S10527-001)		1
	Needle thread trimmer fixed knife 	Fixed knife (8 – 12) (S08399-001)			Fixed knife (14 - 16) (S10528-001)		1
	Needle thread trimmer thread retainer spring 	Thread retainer spring (8 - 12) (S08401-001)			Thread retainer spring (14 - 16) (S10529-001)		1
	Lower tread trimmer link 	Link (B) (S08385-001)	Link (B) (S08385-002)	Link (B) (S08385-003)	Link (B) (S08385-004)	Link (B) (S08385-005)	1
Corner knife	Base 	Knife base assy, 8 (S11521-001)	Knife base assy, 10 (S11522-001)	Knife base assy, 12 (S11523-001)	Knife base assy, 14 (S11524-001)	Knife base assy, 16 (S11525-001)	2
	Right knife <b>*BAS610A, 611A, 613A</b> 	Corner knife (S-Right) (S08322-001)				Corner knife (L-Right) (S09416-001)	2
	Left knife <b>*BAS610A, 611A, 613A</b> 	Corner knife (S-Left) (S08302-001)				Corner knife (L-Left) (S09417-001)	2
	Right knife <b>*BAS612A</b>	Corner knife (L-Right) (S09416-001)					2
	Left knife <b>*BAS612A</b>	Corner knife (L-Left) (S09417-001)					2
Binder, single welting  					Folding plate supporter (S11520-001)	1	
					Screw 3 × 5 (004300-513)	2	

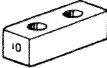











## Gauge parts list

Part name		Needle gauge					Q'ty
		8 mm	10 mm	12 mm	14 mm	16 mm	
Carriage feed adjusting gauge 		Movable base spacer (S08513-001)	Movable base spacer (S08513-002)	Movable base spacer (S08513-003)	Movable base spacer (S08513-004)	Movable base spacer (S08513-005)	1
Spacer for carriage feed	Spacer (S) 	t = 6 (S08510-101)	t = 5 (S08510-102)	t = 4 (S08510-103)	t = 3 (S08510-104)	t = 2 (S08510-105)	2
	Spacer (W) 	t = 3.5 (S08511-101)	t = 4.5 (S08511-102)	t = 5.5 (S08511-103)	t = 6.5 (S08511-104)	t = 7.5 (S08511-105)	2
Gauge for flap *BAS611A & 612A 		Flap spacer (S11304-001)	Flap spacer (S11304-002)	Flap spacer (S11304-003)	Flap spacer (S11304-004)	Flap spacer (S11304-005)	2
		-	Screw 3 × 16 (062301-605)		Screw 3 × 20 (062302-005)		4
Cloth slide plate	Right 	Slide plate (Right) assy (S08195-001)			Slide plate (Right) assy (S09452-001)		1
	Left 	Slide plate (Light) assy (S08198-001)			Slide plate (Left) assy (S09454-001)		1
Machine head	Needle clamp *BAS610A, 611A, 613A 	Needle clamp assy, 8 (S00935-001)	Needle clamp assy, 10 (158810-001)	Needle clamp assy, 12 (158811-001)	Needle clamp assy, 14 (S09466-001)	Needle clamp assy, 16 (S00936-001)	1
	Needle clamp *BAS612A 	Needle clamp set 8L (S14607-001)	Needle clamp set 10L (S14609-001)	Needle clamp set 12L (S14611-001)	Needle clamp set 14L (S14613-001)	Needle clamp set 16L (S14615-001)	1
		Needle clamp assy 8L (S15826-001)	Needle clamp assy 10L (S15830-001)	Needle clamp assy 12L (S15834-001)	Needle clamp assy 14L (S15838-001)	Needle clamp assy 16L (S15842-001)	1
		Needle clamp assy 8R (S14608-001)	Needle clamp assy 10R (S14610-001)	Needle clamp assy 12R (S14612-001)	Needle clamp assy 14R (S14614-001)	Needle clamp assy 16R (S14616-001)	1
		Needle clamp assy 8R (S15827-001)	Needle clamp assy 10R (S15831-001)	Needle clamp assy 12R (S15835-001)	Needle clamp assy 14R (S15839-001)	Needle clamp assy 16R (S15843-001)	1
		Needle plate 	Needle plate 8 (S09461-001)	Needle plate 10 (153022-001)	Needle plate 12 (156060-001)	Needle plate 14 (S09462-001)	Needle plate 16 (S09463-001)
Carriage feed rubber 	t = 2 mm (S08267-002)	t = 3 mm (S08267-003)	t = 4 mm (S08267-004)	-	-	2	







## Gauge parts list

Part name		Needle gauge		Q' t y
		18 mm	20 mm	
Thread trimmer	Needle thread trimmer movable knife 	Needle thread knife (18 – 20) (S10552-001)		1
	Needle thread trimmer fixed knife 	Fixed knife (18 – 20) (S10553-001)		1
	Needle thread trimmer thread retainer spring 	Thread retainer spring (18 – 20) (S10554-001)		1
	Lower tread trimmer link 	Link (B) (S08385-006)	Link (B) (S08385-007)	1
Corner knife	Base 	Knife base assy, 18 (S11526-001)	Knife base assy, 20 (S11527-001)	2
	Right knife 	Corner knife (L-Right) (S09416-001)		2
	Left knife 	Corner knife (L-Left) (S09417-001)		2
Binder, single welting  	Folding plate supporter (S11520-001)		1	
	Screw 3 × 5 (004300-513)		2	

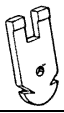
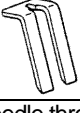
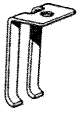
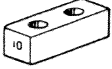
## Gauge parts list







Part name		Needle gauge		Q' t y
		18 mm	20 mm	
Carriage feed adjusting gauge 		Movable base spacer (S08513-006)	Movable base spacer (S08513-007)	1
Spacer for carriage feed	Spacer (S) 	t = 1 (S08510-106)	-	2
	Spacer (W) 	t = 8.5 (S08511-106)	t = 9.5 (S08511-107)	2
Spacer for folding plate <b>*BAS610 A, 611A, 612A</b>	Spacer (S) 	t = 3.5 (S09688-006)	-	2
	Spacer (W) 	t = 8.5 (S09689-006)	t = 9.5 (S09689-007)	2
Gauge for flap 		Flap spacer (S11304-006)	Flap spacer (S11304-007)	2
		Screw 3 × 25 (062302-505)		4
Cloth slide plate	Right 	Slide plate (Right) assy (S09453-003)		1
	Left 	Slide plate (Left) assy (S09455-003)		1
Machine head	Needle clamp <b>*BAS610A, 611A, 613A</b> 	Needle clamp assy, 18 (S09468-001)	Needle clamp assy, 20 (S00937-001)	1
	Needle clamp <b>*BAS612A</b>  	Needle clamp set 18L (S14617-001)	Needle clamp set 20L (S14619-001)	1
		Needle clamp assy 18L (S15846-001)	Needle clamp assy 20L (S15850-001)	1
		Needle clamp set 18R (S14618-001)	Needle clamp set 20R (S14620-001)	1
		Needle clamp assy 18R (S15847-001)	Needle clamp assy 20R (S15851-001)	1
	Needle plate 	Needle plate 18 (S09464-001)	Needle plate 20 (S09465-001)	1
Carriage feed rubber 		-	-	-

## Gauge parts list

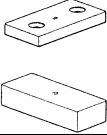
Part name		Needle gauge			Q' t y
		22 mm	24 mm	26 mm	
Thread trimmer	Needle thread trimmer movable knife 	Needle thread knife (22 – 26) (S34643-001)			1
	Needle thread trimmer fixed knife 	Fixed knife (22 – 26) (S34644-001)			1
	Needle thread trimmer thread retainer spring 	Thread retainer spring (22 - 26) (S34642-001)			1
	Lower tread trimmer link 	Link (B) (S08385-008)	Link (B) (S08385-009)	Link (B) (S08385-010)	1
Corner knife	Base 	-	-	-	-
	Right knife 	-	-	-	-
	Left knife 	-	-	-	-
Binder, single welting  	-	-	-	-	
	-	-	-	-	

\*For gauge 22 mm, 24 mm, and 26 mm, order the adjustable corner knife.

## Gauge parts list

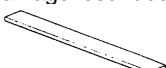
Part name		Needle gauge			Q't y
		22 mm	24 mm	26 mm	
Carriage feed adjusting gauge 		Movable base spacer (S08513-008)	Movable base spacer (S08513-009)	Movable base spacer (S08513-010)	1
Spacer for carriage feed	Spacer (S) 	-	-	-	2
	Spacer (W) 	t = 10.5 (S08511-108)	t = 11.5 (S08511-109)	t = 12.5 (S08511-110)	2
Cloth slide plate	Right 	(S31229-004)			1
	Left 	(S31230-004)			1
Machine head	Needle clamp 	Needle clamp assy, 22 (S35587-001)	Needle clamp assy, 24 (S35588-001)	Needle clamp assy, 26 (S35589-001)	1
	Needle plate 	Needle plate 22 (S34616-001)	Needle plate 24 (S34617-001)	Needle plate 26 (S34618-001)	1
Carriage feed rubber 		t = 2 mm (S08267-002)	t = 3 mm (S08267-003)	t = 4 mm (S08267-004)	2

\*For gauge 22 mm, 24 mm, and 26 mm, order the adjustable corner knife.







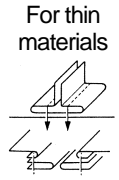
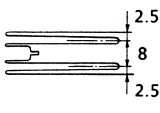
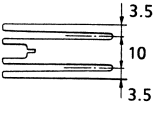
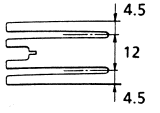
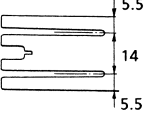
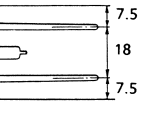
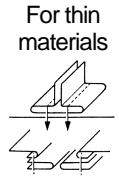
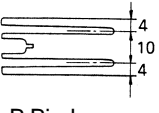
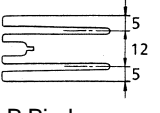

## Option gauge parts

Part name		Needle gauge					Q' t y
		8 mm	10 mm	12 mm	14 mm	16 mm	
*BAS610A & 611A Option parts	Ceramic corner knife	Ceramic corner knife (Small) S14050-001				Ceramic corner knife (Large) S14051-001	4
*BAS612A Option parts	Knife (Right)	Corner knife (S-Right) (S08322-001)					2
	Knife (Left)	Corner knife (S-Left) (S08302-001)					2
	Knife base	Knife base set 8 (S15881-001)	Knife base set 10 (S15882-001)	Knife base set 12 (S15883-001)	Knife base set 14 (S15884-001)	Knife base set 16 (S15885-001)	1
		Knife base assy 8 (S14737-001)	Knife base assy 10 (S14739-001)	Knife base assy 12 (S14741-001)	Knife base assy 14 (S14743-001)	Knife base assy 16 (S14745-001)	1
	Ceramic corner knife	Ceramic corner knife (Small) (S14050-001)				Ceramic corner knife (Large) (S14051-001)	4
*BAS613A Option parts	Ceramic corner knife	Ceramic corner knife (Small) (S14050-001)					4
		Ceramic corner knife (Large) (S14051-001)					4

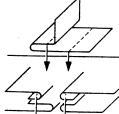
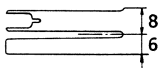
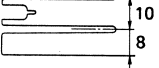
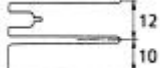
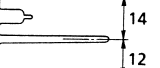
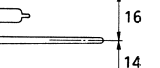

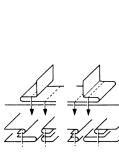
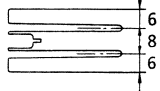
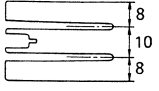
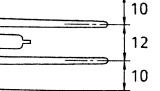
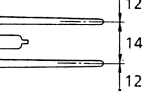
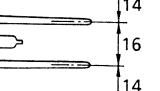

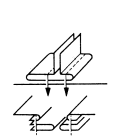
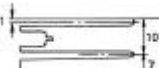

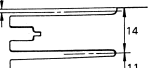
Part name		Needle gauge					Q' t y
		18 mm	20 mm	22 mm	24 mm	26 mm	
*BAS610A & 611A Option parts	Ceramic corner knife	Ceramic corner knife (Large) S14051-001			-		4
*BAS612A Option parts	Knife (Right)	Corner knife (S-right) (S08322-001)			-		2
	Knife (Left)	Corner knife (S-left) (S08302-001)			-		2
	Knife base	Knife base set 18 (S15886-001)	Knife base set 20 (S15887-001)	-			1
		Knife base assy 18 (S14747-001)	Knife base assy 20 (S14749-001)	-			
	Ceramic corner knife	Ceramic corner knife (Large) (S14051-001)			-		4
*BAS613A Option parts	Ceramic corner knife	Ceramic corner knife (S) (S14050-001)			-		4
		Ceramic corner knife (L) (S14051-001)			-		4



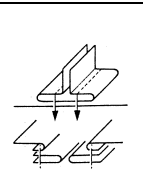
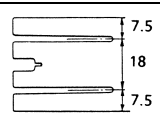
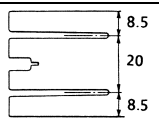

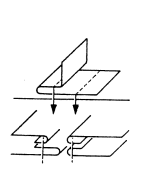
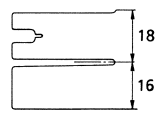
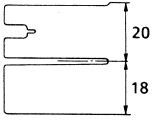

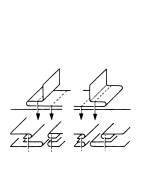
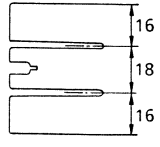
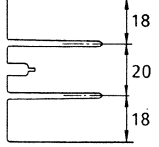
# Binder

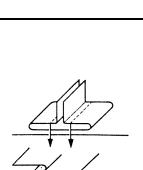
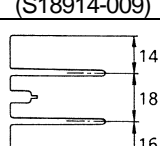
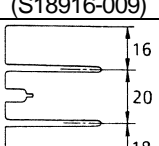
Part name		Needle gauge					Q' t y
		8 mm	10 mm	12 mm	14 mm	16 mm	
<b>Double welding</b> 		 Binder assy 8W (S14709-009)	 Binder assy 10W (S14713-009)	 Binder assy 12W (S14717-009)	 Binder assy 14W (S14721-009)	 Binder assy 16W (S14725-009)	1
	For thin materials 	-	 B Binder assy 10W (S18577-009)	 B Binder assy 12W (S18579-009)	-	-	1
<b>Single welding</b> 		 Binder assy 8S (S14711-009)	 Binder assy 10S (S14715-009)	 Binder assy 12S (S14719-009)	 Binder assy 14S (S14723-009)	 Binder assy 16S (S14727-009)	1
<b>Single welding</b> 		 C Binder assy 8S (S18906-009)	 C Binder assy 10S (S18908-009)	 C Binder assy 12S (S18793-009)	 C Binder assy 14S (S18910-009)	 C Binder assy 16S (S18912-009)	1
<b>Off-set welding</b> 		-	 Off-set binder assy (S15602-009)	 Off-set binder assy (S15604-009)	 Off-set binder assy (S15606-009)	-	1

# Binder

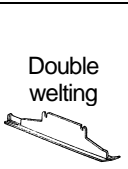
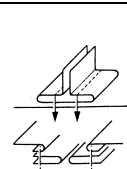
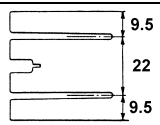
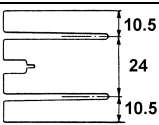
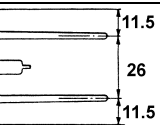
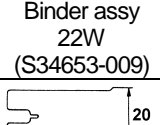
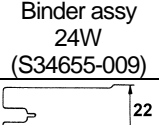
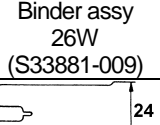
Part name		Needle gauge		Q' t y
		18 mm	20 mm	
 <p>Double welting</p>		 <p>Binder assy 18W (S14729-009)</p>	 <p>Binder assy 20W (S14733-009)</p>	1
 <p>Single welting</p>		 <p>Binder assy 18S (S14731-009)</p>	 <p>Binder assy 20S (S14735-009)</p>	1
 <p>Single welting</p>		 <p>C Binder assy 18S (S18914-009)</p>	 <p>C Binder assy 20S (S18916-009)</p>	1
 <p>Overlapped single welting</p>		 <p>D Binder assy 18S (S18795-009)</p>	 <p>D Binder assy 20S (S18797-009)</p>	1

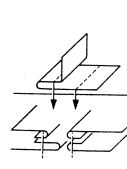
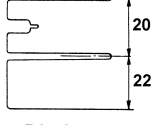
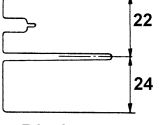
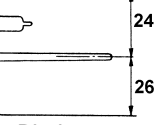
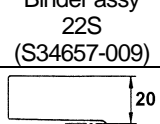
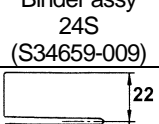
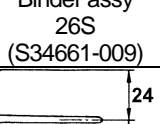
# Binder

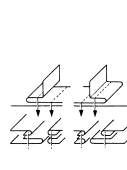
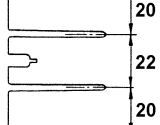
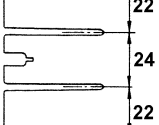
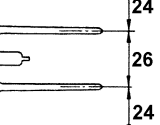
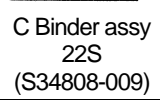
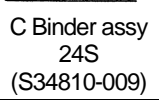
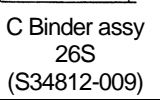
Part name		Needle gauge			Q' t y
		22 mm	24 mm	26 mm	
 <p>Double welting</p>		 <p>Binder assy 22W (S34653-009)</p>	 <p>Binder assy 24W (S34655-009)</p>	 <p>Binder assy 26W (S33881-009)</p>	1
					
 <p>Single Welting</p>		 <p>Binder assy 22S (S34657-009)</p>	 <p>Binder assy 24S (S34659-009)</p>	 <p>Binder assy 26S (S34661-009)</p>	1
					
 <p>Single welting</p>		 <p>C Binder assy 22S (S34808-009)</p>	 <p>C Binder assy 24S (S34810-009)</p>	 <p>C Binder assy 26S (S34812-009)</p>	1
					

## Option parts

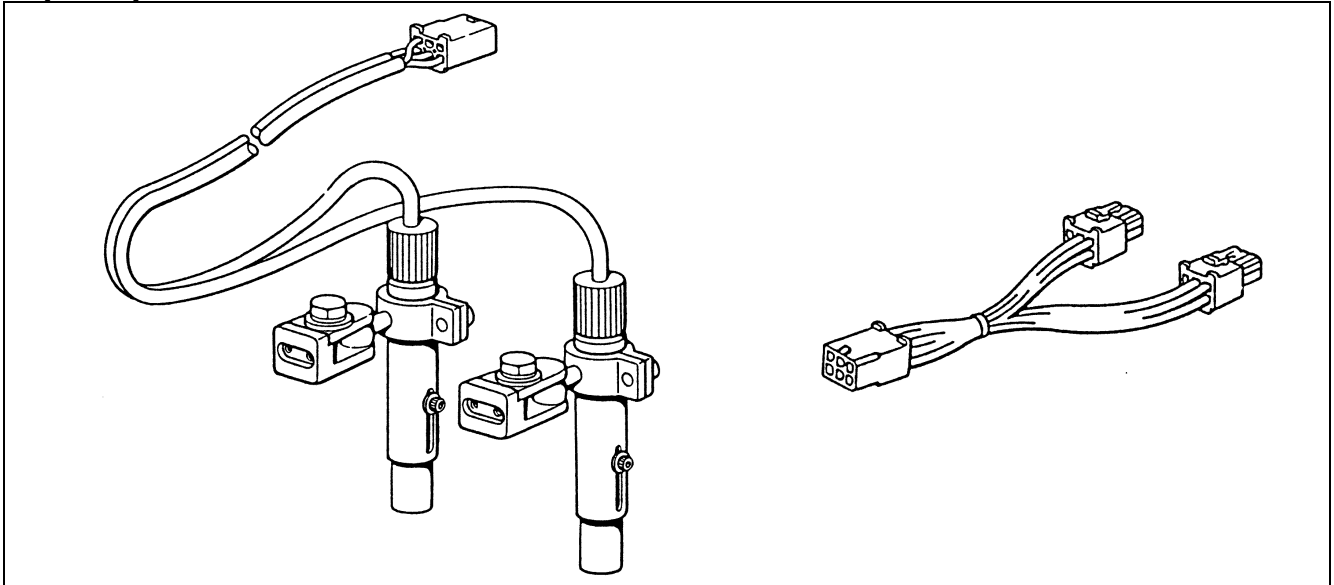

Part name	Part code
Marking light assy (E)	S18940-000
Marking light (E)	S18894-000
Marking light harness	S18942-000

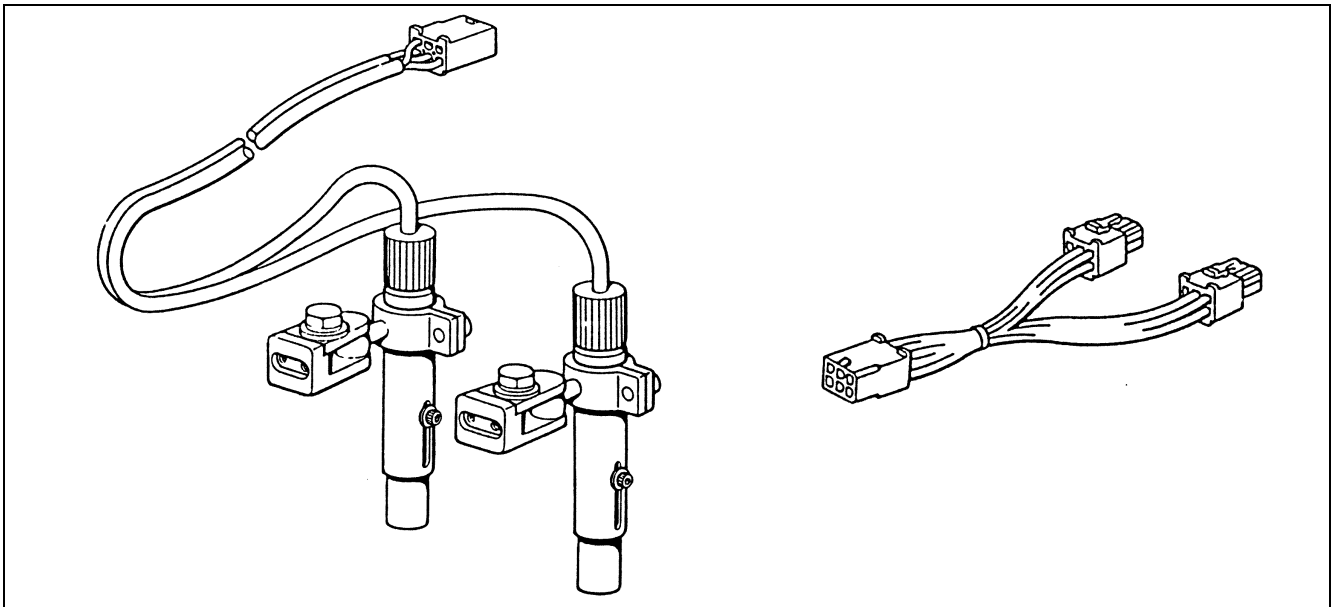

Part name	Part code
Marking light assy (L)	S18941-000
Marking light (L)	S18895-001
Marking light harness	S18942-000